



Integrated Control Interface Plus (ICI+)

Installation Manual





| | |
|---|----|
| <i>Prior to Installation: Verify Communication Protocol</i> | 3 |
| <i>Installing the ICI+</i> | 4 |
| <i>Installation Checklist</i> | 5 |
| <i>Verify Contents of the Packing Box</i> | 6 |
| <i>Recommended Power Supply Methods and Devices</i> | 7 |
| <i>Choose Location to Mount the ICI+</i> | 8 |
| <i>Gather Installation Tools</i> | 9 |
| <i>Mount ICI+</i> | 10 |
| <i>Connect ICI+ Ground Wire (Not Included)</i> | 11 |
| <i>Connect Field Wiring</i> | 12 |
| <i>USB Connections</i> | 13 |
| <i>Radio (LINK) Connections</i> | 14 |
| <i>Connect Source Power</i> | 15 |
| <i>Complete Installation</i> | 16 |
| <i>Appendix - Grounding Requirements</i> | 17 |
| <i>Grounding Requirements for the IC System™</i> | 18 |
| <i>Central Grounding Grid</i> | 19 |
| <i>LINK Radio Antenna, Coaxial Cable and Grounding Installation Steps</i> | 20 |
| <i>Coaxial Cable Connection to ICI+LINK Module</i> | 24 |
| <i>LINK Radio Installation Detail for Base Antenna, Coaxial Cable & Grounding Wires</i> | 25 |
| <i>Antenna Grounding Lug Mounting Detail</i> | 26 |
| <i>Weatherproofing Coaxial Cable Connections</i> | 27 |
| <i>Mounting and Wiring of Polyphaser Surge Arrestor</i> | 28 |
| <i>Installation Detail for 3-Rod Grounding Grid at Central Location</i> | 29 |
| <i>ICI+ System Specifications</i> | 30 |

Prior to Installation: Verify Communication Protocol

Verify the switch on your ICI+ CPU board, located inside of the box in the top left corner, is toggled to the correct communication protocol based on the type of field hardware you have installed. The switch is located in the top right corner of the CPU board (see Figure A). If the switch is not in the correct position, simply toggle it to the correct one.

IC System™ (Only)

The switch must be toggled up, to TWX. The LED light on ICI+ door should be green.

IC System™ and 2-Wire Satellites (with IFX boards) or LINK Satellites (with IFB LINK or IFX LINK boards)

The switch must be toggled up, to TWX. The LED light on ICI+ door should be green.

Satellites (Only)

The switch must be toggled down, to TWI. The LED light on ICI+ door should be amber.

LINK (Radio) Satellites (ICI+LINK)

The switch can be TWI or TWX. The LED light should be red. Note: if you install a separate ICI+ Two-Wire driver board, refer to two-wire systems detailed above.

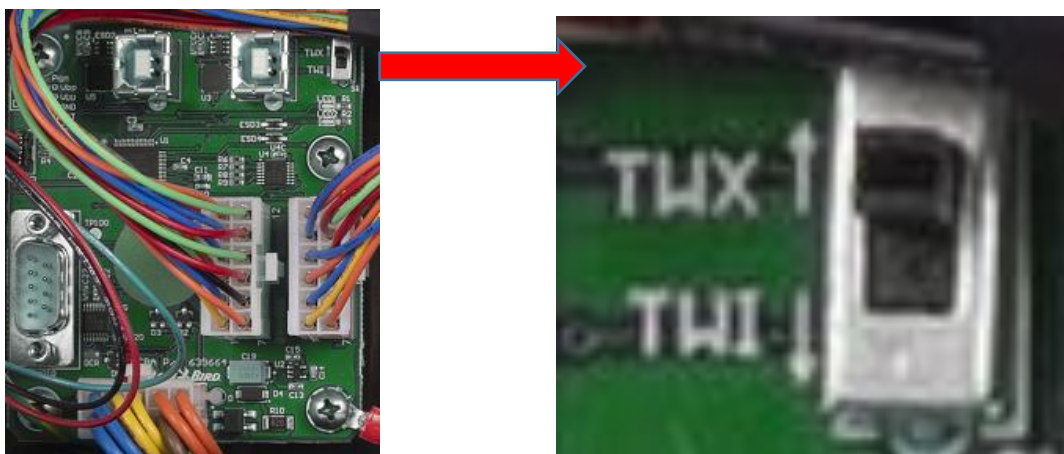

Figure A

Installing the ICI+

This section explains how to mount the ICI+ on the wall and connect the wiring.



NOTE: The ICI+ must be installed in compliance with all local electrical codes and must be installed in an environmentally sealed environment.



NOTE: The installation of the ICI+ should be done with power supply disconnected.



NOTE: Do not connect the USB cable to the central control computer until the Central Control software has been loaded. Specific drivers are required to operate the Interface through the Central Control System.



NOTE: If working with the TWX wire path setting, please allow 2 minutes after wire path has been activated before communicating with field devices (ICMs, Satellites, etc)



NOTE: Field wire paths must be kept separate from other wire paths. Do not connect the field wires together from different output (group) wire paths as this may cause equipment damage.



Installation Checklist

We recommend you complete the following steps in order to properly install the ICI+. For your convenience, a check-off box has been provided for each step.

- Verify the contents of the packing box
- Verify recommended Power Supply Method and Device
- Choose a location to mount the ICI+
- Gather installation tools and five #8 screws
- Obtain mounting hardware and attach the ICI+ to the wall
- Connect ICI+ Ground Wire
- Connect field wiring
- Connect power supply
- Install version 8.1 or later of the central control software in the computer
- Attach USB cables after version 8.1 or later central control software is loaded and opened
- Power up the ICI+ and wire paths individually to complete the installation



Verify Contents of the Packing Box

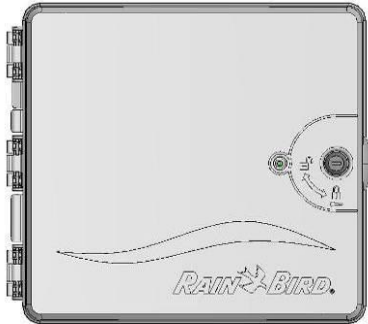

ICI+

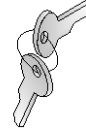

Keys

Rain Bird Manuals:
ICI+ Installation Manual &
IC System™ Tips for a
Successful Installation

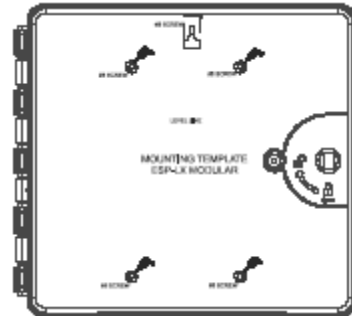

Mounting Template

In some markets the following will also be included:

- Power supply cord
- USB cable(s)

(If these cables are not included in the box, please contact your distributor)

Recommended Power Supply Methods and Devices

Main - Incoming Power Supply

- Use a dedicated circuit to supply power to the Rain Bird Irrigation Equipment.
 - This reduces potential electrical noise from air conditioning and other industrial equipment.
- Install a power surge arrestor such as a Tyte-wadd Zap Trap or similar surge arrestor to protect the circuit.
- Power the computer and ICI+ from an uninterruptable power supply (UPS) battery back-up (1500 VA or higher recommended).
- If a temporary generator is necessary, ensure it is designed for sensitive electronics and has a pure sine wave output. Rain Bird has had success with Honda's EU models:

<http://powerequipment.honda.com/generators/industrial-generators>

Uninterruptable Power Supply (UPS)

- The UPS must produce a “pure sine wave” not a “modified, stepped, square or PWM” wave form while on battery power.
- A modified or stepped sine wave may cause poor or no communication to Integrated Control Modules (ICMs) during power failures, including potential erroneous operation.
- Rain Bird has verified the APC Smart-UPS 1500 for IC System™ use.
- If you have questions about a specific model, please contact Rain Bird GSP.

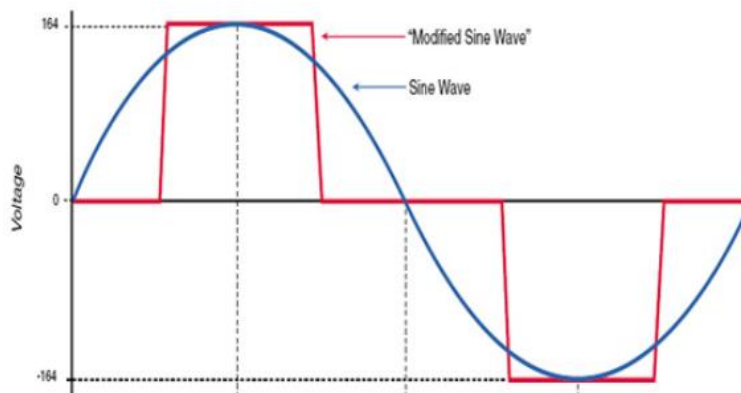

Choose Location to Mount the ICI+

Choose an indoor location that:

- Is easily accessible
- Allows for comfortable viewing
- Has a flat wall surface
- Is near a 100V, 120 V or 230/240 V AC dedicated power source, depending on model
- Is located within 5 feet (1.5 meters) of the Central Control computer – this can be increased up to 25 feet (7.5 meters) with a longer USB cable (not supplied)
- Located as close to the incoming MAXI™ field wire paths and grounding grid as possible

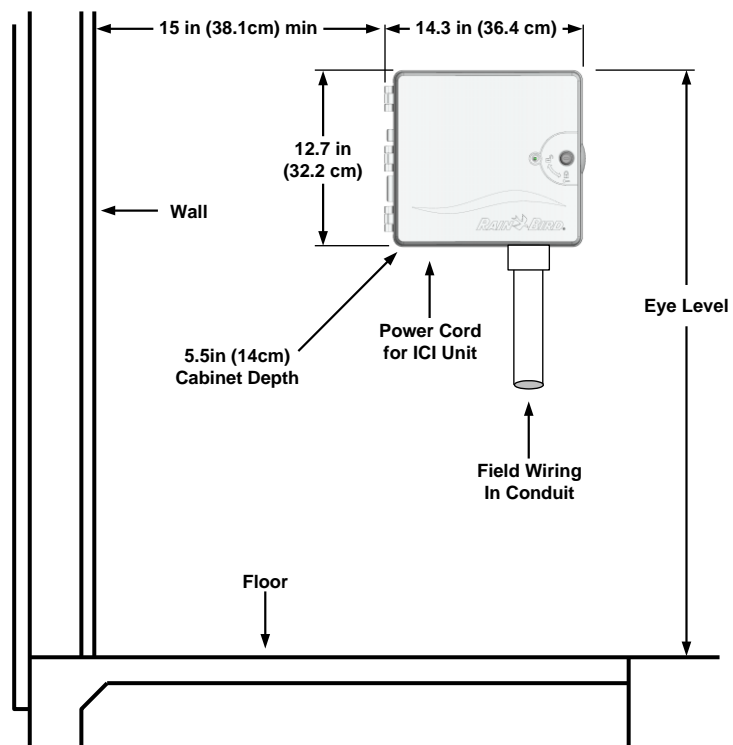

NOTE: The ICI+ must be installed in compliance with all local electrical codes.

Gather Installation Tools



Phillips head screwdriver



Slotted thin-blade screwdriver

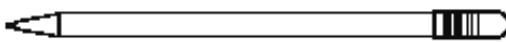

Marking Pencil



Metal drill bit(s)

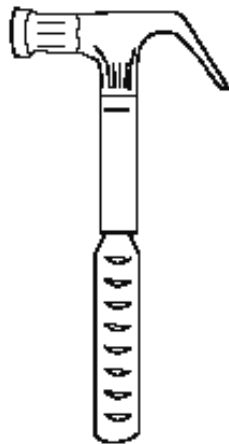

Hammer

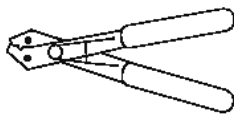

Wire strippers

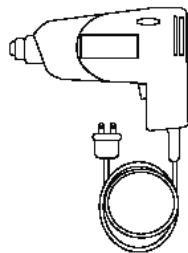

Electric drill (or hammer drill if installing in masonry or concrete)

Mount ICI+

1. Drill or tap a pilot hole on each mark for the mounting holes.
2. Remove the mounting template from the surface prior to installation. If necessary, install drywall anchors. Drive a #8 screw into the top center pilot hole.
3. If necessary, unlock the door with the supplied key. Open the door of the cabinet and swing it to the left.
4. Remove the foam insert used to stabilize the transformer during shipping
5. Attach the mounting template to the mounting surface at eye level using the mounting guide in the back center of the plastic housing. Make sure that at least one of the mounting holes lines up with a wall stud or other solid surface, preferably on the left side of the template where the transformer is located. Make sure the template is level
6. Slide the ICI+ over the top center screw. Line up the ICI+ cabinet with the remaining four pilot holes. Drive the appropriate #8 screws through the mounting holes into the mounting surface. Verify that the cabinet is secure.

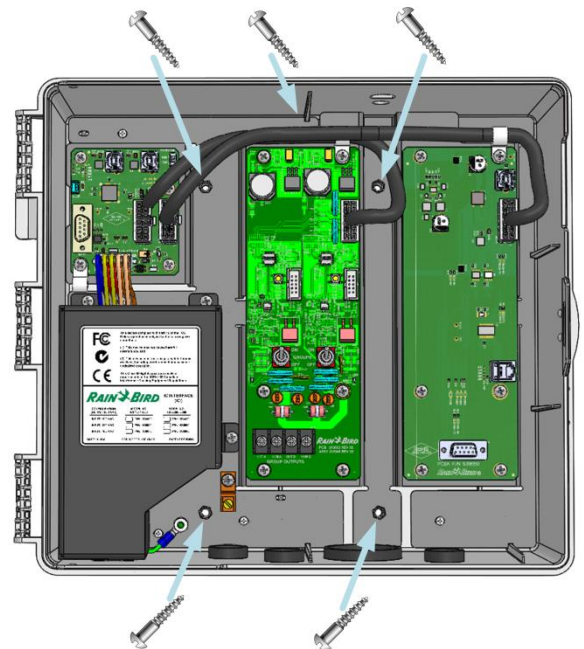
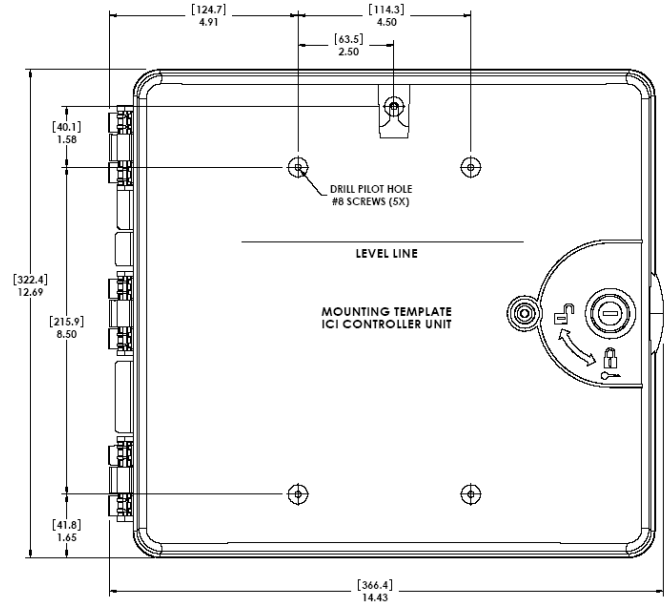

NOTE: The ICI+ must be installed indoors only.

Connect ICI+ Ground Wire (Not Included)

A #6 (4 mm) gauge ground wire should be installed in a separate conduit between the ICI+ and the ground grid. A conduit no less than 1-1/2" (40 mm) in diameter shall be installed through the wall to the valve box that contains the first rod in the ground grid. The ground wire may be connected to the ground rod with a four way Cad Weld exothermic weld or acorn nut sharing the ground wires from the FREEDOM antenna, Polyphaser, ground grid, and shielding wire when present.

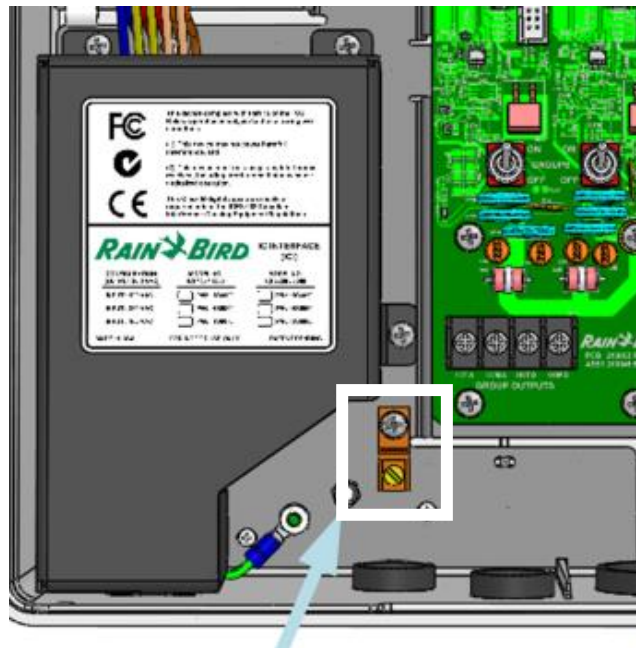

Connect Field Wiring

Field wires are connected to the Driver Boards using screw terminals located at the bottom of the board. The Integrated Control Interface Plus (ICI+) comes with two ICI+ Driver Boards, for a total of four wire path outputs. Each wire path supports up to 750 ICM equivalent devices. (See technical specifications for ICM equivalency of IC CONNECT™ devices).

2-Wire Path Connections

On the lower left corner of each ICI+ Driver Board is a 4-terminal connection block (see Figure B). The left board contains wire paths #1 and #2 and the right board contains wire paths #3 and #4.

FOR WIRE PATH 1:

1. Connect the HOT (red) wire of the 2-wire communication path to the left terminal position labeled "HOT A".
2. Connect the COM (black) wire of the 2-Wire communication path to the neighboring terminal position labeled "COM A".

FOR WIRE PATH 2:

1. Connect the HOT (red) wire of the 2-Wire communication path to terminal position labeled "HOT B".
2. Connect the COM (black) wire of the 2-Wire communication path to terminal position labeled "COM B".

FOR WIRE PATHS 3 & 4 (2nd Driver Board):

Repeat steps above for wire paths 3 & 4 on the second driver board located on the right.

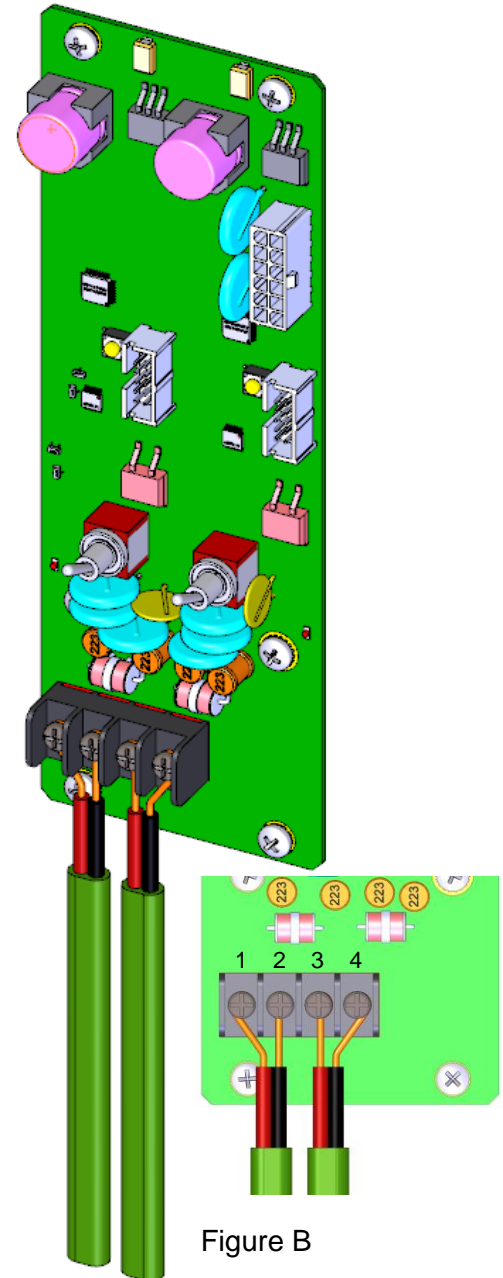

Figure B

USB Connections

Connect USB Cables from your computer to the USB Port(s) inside of the ICI+ or ICI+LINK interface according to the type of field hardware. You must have one USB cord per type of field hardware you have installed:

IC System™ ONLY

Connect the USB cord to the USB connector, labeled “ICI”, located on the upper RIGHT side of the CPU board, which is located in the top left corner of the ICI+ box (see Figure C).

ICI+ with Satellites ONLY

Connect the USB cord to the USB connector, labeled “MIM”, located on the upper LEFT side of the CPU board, which is located in the top left corner of the ICI+ box (see Figure C).

ICI+ with IC System™ AND Satellites

Connect one USB cord to the “ICI” USB connector and a second USB cord to the “MIM” USB connector, located on the top of the CPU board, which is located in the top left corner of the ICI+ box (see Figure C).

ICI+LINK (Radio) with LINK Satellites

Connect the USB cord from the computer to the USB connector located on the upper right side of the ICI+ LINK board (see Figure E).

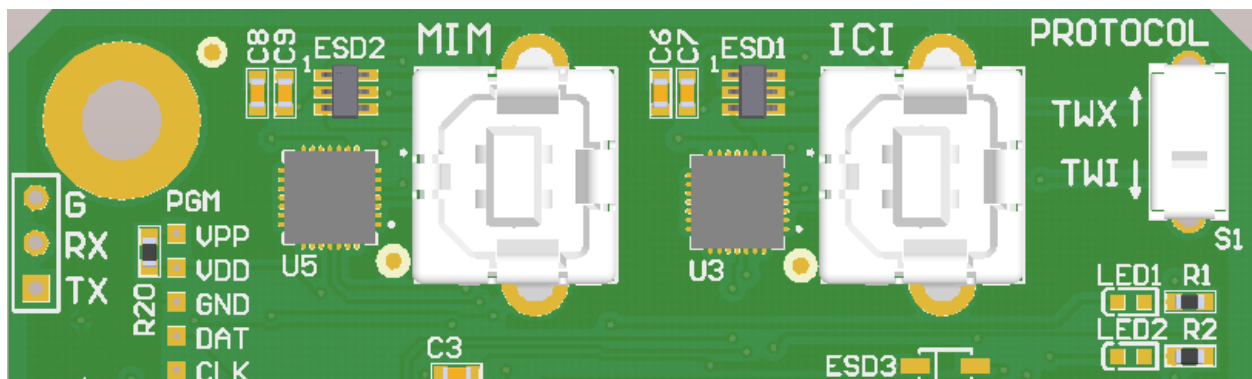

Figure C

Radio (LINK) Connections

On the lower edge of the IFX-Link Printed Circuit Board Assembly (Figure D) is a 9-Pin DSUB connection block (see Figure E). The radio used for communication with the Satellites connects to the DSUB connector and is used for power and communications to the field.

FOR RADIO (LINK) Connections:

1. Connect the 9-Pin cable from the Radio to the lower DSUB connector on the IFX-Link circuit board.
2. Attach the radio to a convenient location in/on the ICI+.
3. Connect the USB cord from the computer to the USB connector located on the upper right corner of the ICI+ LINK board (see Figure F).

NOTE: See Appendix for antenna, coaxial cable and grounding installation details and diagrams.

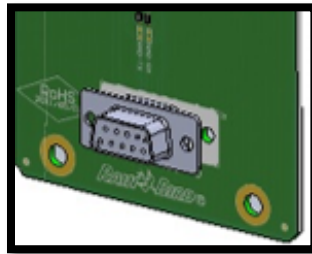

Figure E



Figure F

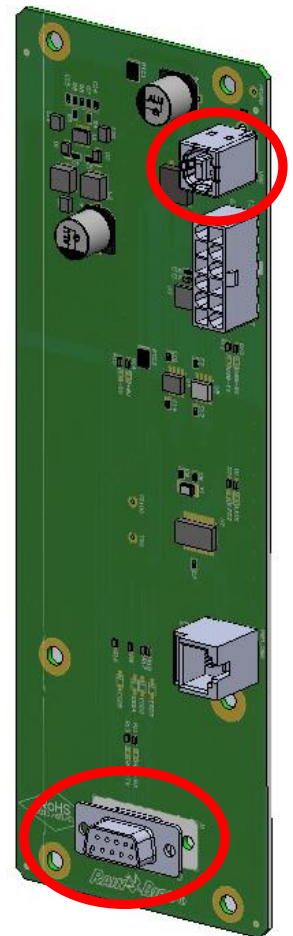

Figure D

Connect Source Power

The ICI+ has an internal transformer that reduces supply voltage (120 VAC, 230/240 VAC and 100 VAC) to 24 VAC - to operate the CPU and Driver Board and power the ICMs on each wire path.



NOTE: Each ICI+ is specifically configured based upon the power supply requirements where the system will be installed.



CAUTION: All electrical wiring connections and wiring runs must be made according to local building codes.

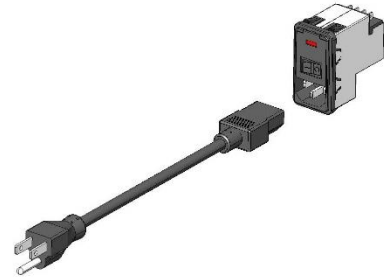

Once these precautions have been met, it is safe to plug in the supplied power cordset into the Power Entry Module located on the bottom left of the ICI+.

In the event that you must change the Source Power protection fuse, please refer to the photo at right.

Carefully pry open the hinged door using a small straight-blade screwdriver.

This will allow access to the red fuse carrier; carefully pull this straight out to expose the specified 1.5 amp slow blow ($\frac{1}{4}$ x $1\frac{1}{4}$) fuse sized for your voltage application. Install in the reverse procedure and hinge up the locking door until it clicks into place.

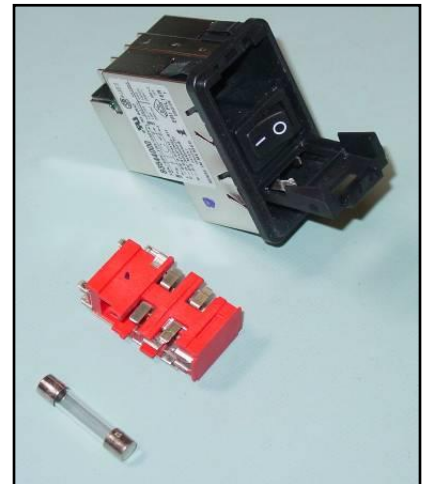



Complete Installation

1. Double-check that:
 - a. The ICI+ is mounted securely to the wall*
**The ICI+ must be installed indoors as it is not rated for outdoor use*
 - b. Conduit for field wiring (if used) is attached securely
 - c. The power cord easily reaches the power entry module on the bottom of the ICI+ with no strain on the cord or ICI+
 - d. LED light on the ICI+ door indicates the correct communication: green for TWX (satellites with IFX boards and/or IC System™) or amber (TWI for satellites only, with IFB and/or IFX boards).
2. Plug in the power cord and turn the switch on.
3. Load version 8.1 or later central control software in the computer.
4. Attach USB cable(s) to computer after version 8.1 or later central control software is loaded and opened.
5. Verify communication with the central control computer.
6. Congratulations! You have successfully installed the ICI+ interface.

Appendix - Grounding Requirements

To prevent lightning damage to your equipment, Rain Bird recommends installing a grounding system for the equipment (including interfaces, weather stations, and central control systems).

The grounding system discharges lightning-induced electrical current into the earth rather than allow the surge to pass through power wires or field wires to your equipment's electronic components.

Ground Resistance

Ground resistance occurs when grounding system components, or the soil itself, oppose the flow of electricity into the earth. Ground resistance is measured in units called "ohm" (Ω). The higher the ground resistance (higher ohm readings), the less chance the surge will be shunted to ground rather than to the equipment's electronic components.

To decrease ground resistance, Rain Bird recommends irrigating the soil around the grounding system. Each grounding system may require a dedicated irrigation zone with sprinkler heads and its own watering program to maintain soil moisture around the grounding system.



NOTE: For more details on grounding system requirements and designs for field controllers and central control systems, refer to each product's installation manual.



Grounding Requirements for the IC System™

Proper grounding is very important for the IC System. Ensure Rain Bird MSP surge devices are installed on each wire path prior to entering the Integrated Control Interface Plus (ICI+) at the central.

Important!

At the ICI+, for a long run (greater than 500 feet or 150 meters) at the beginning of the wire path, the MSP should be installed at the interface and an ICSD installed just prior to the first ICM on the wire path.

The grounding requirement at the Central Control is to have less than 10 ohms of earth ground resistance; 5 ohms or less of ground resistance is preferable. The Central Control requires MAXI™ Surge Protectors (MSP-1) on each wire path with MAXI Ground Plates (MGP-1).

The primary objective of grounding is to achieve the desired earth ground reading for the rods or plates regardless of which method is used. Rain Bird has had good success with ground rods when soil conditions allow them to be driven completely into the soil profile. An 8 foot (2.4 m) rod will help distribute a surge into lower layers of the soil profile, away from the soil surface and equipment.

Installation Requirements

The following requirements apply to all grounding system designs. All grounding rods or plates must be connected together below grade with #6 AWG or larger solid bare copper wire. Install the connecting wire in as straight a line as possible. If you must make a turn or bend in the wire, make the turn in a sweeping curve with a minimum radius of 8" and a minimum included angle of 90°. To minimize resistance, the copper wire must be pre-welded to the grounding rods/plates, or welded to the rods/plates using an exothermic welding process at the site. Make sure all welds are secure before burying the grounding rods. Rods and plates with welded joints do not need periodic visual inspection and can be fully buried (no valve box required). Measure the ground resistance around the grounding system after installation, and once every year after that.



NOTE: The ground wire from the equipment to the grounding system should be as short as possible and have no bends, kinks, or coils in the wire. Inspect the grounding system's clamped connections to the equipment (not the welded grounding system connections) once a year to make sure they are secure and corrosion-free.

Central Grounding Grid

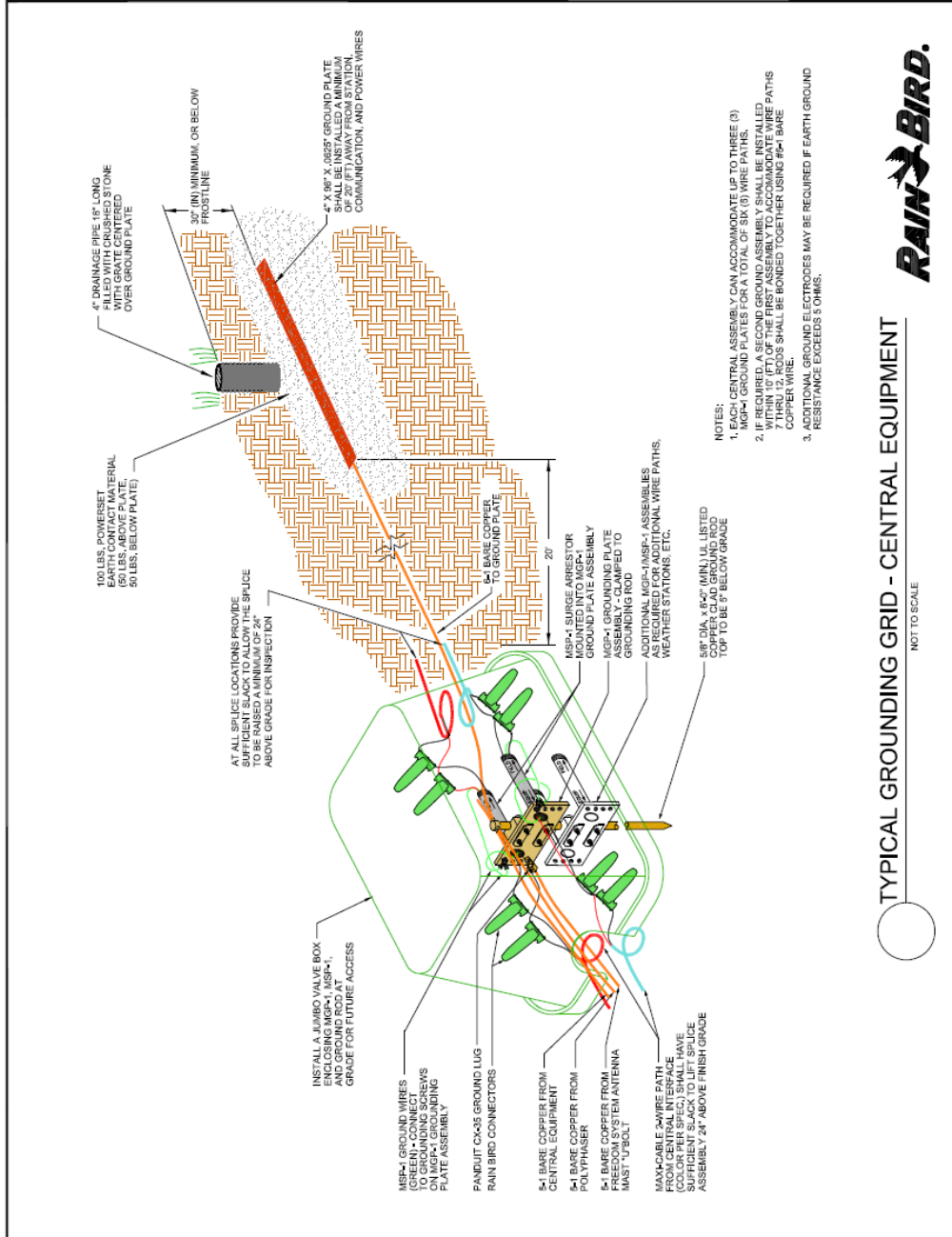



LINK Radio Antenna, Coaxial Cable and Grounding Installation Steps

Step 1: See Figure G

Route the coaxial cable of the radio unit through the opening on the bottom of the ICI+ box.

Step 2: See Figure H

On the building that houses the Central Equipment and the ICI+ LINK, or on a suitable antenna tower, mount a Model ANT-02, ANT-03 or a Yagi Type Base Antenna for the ICI+LINK unit. The installation will require the following equipment for a successful installation:

- Base Type Antenna (not included) Rain Bird Model ANT-02, ANT-03 or Yagi Type Antenna.
- Metal Mounting Clamps or Brackets, as required for mounting the Antenna to the building or tower.
- Panduit Model CX70-14-C copper grounding terminal lug (not included in Antenna Assembly) for connection of ground wire to Antenna.
- RFN-1034-1 Connector – N (F) x UHF (F) – (not included in Antenna Assembly).
- Two 25'-0" long Coaxial Cables- Model RG8 Type Cable with UHF (M) x UHF (M) Connectors. (Cable is not included in Antenna Assembly).
- Coaxial Cable Waterproofing Putty material. (Not included in Antenna Assembly).
- Plastic Electric Tape as required for sealing Coaxial Cable connection. (Not included in Antenna Assembly).
- #6 Gauge or larger bare copper ground wire – length as may be required. (Not included in Antenna Assembly). Ground wire is for grounding the Antenna and Surge Arrestor for the Coaxial Cable.
- 4'0" long Coaxial Cable - Model SP58A-48BM/UM with BNC (M) x UHF (M) connectors. (May be used in place of the 25'-0" RG8 Type Cable). (Not included in Antenna Assembly).
- Polyphaser Arrestor (Rain Bird Part Number HA1100)
- Metal or plastic straps (quantity as required) for attaching a Coaxial Cable and ground wire to building or tower. (Not included in Antenna Assembly).

Step 3: See Figure H

Select a suitable location for the Antenna, as close to the ICI+LINK unit as possible. Not further than 25'-0" as the total length of the Coaxial Cable is only 25'-0".

Step 4: See Figure H



Using the mounting clamps or brackets, secure the Antenna to the building or Antenna tower.

NOTE: In case a Yagi Antenna is being used, be sure to orient the antenna properly in respect to the ICI+ unit.

Step 5: See Figures H & I

Install the Panduit Model CX70-14-C copper grounding lug to one bolt of one of the mounting clamps.

Step 6: See Figure H

Install a #6 Gauge or larger ground wire into the copper grounding lug and extend this wire down the side of the building or tower. Connect it to one rod of a 3-rod grounding grid, located at the Central Equipment location. The grounding grid should be located as close to the ICI+LINK unit as possible so that it can be grounded to this grid with the shortest length of ground wire possible and with wire being straight and with no kinks in it.

Step 7: Using the 25'-0" Type RG8 Coaxial Cable, connect one end to the N (F) connector of the RFN-1034-1 Cable Connector.

Step 8: Connect the UHF (F) end of the RFN-1034-1 connector to the N (M) connector of the Antenna.

Step 9: See Figure J

This completed connection shall be sealed and waterproofed, as shown in detail in Figure I.

Step 10: See Figure H

Route the Coaxial Cable down the antenna and the side of the building or antenna tower. Secure the cable to the building or tower using suitable straps.

Step 11: See Figures H & K

At the bottom of the Cable – form a “Drip Loop” and then feed the cable through the wall, just below the location where the PolyPhaser Surge Arrestor will be mounted on the inside of the wall.

Step 12: See Figure K

Mount the PolyPhaser Surge Arrestor on the inside wall, near the ICI+LINK unit and near the floor. Use lag screws or other type fasteners, as may be dictated by the type of wall material, for securing the unit to the wall. Make sure that Antenna terminal is down toward the floor.

Step 13: See Figures H & K

Connect the UHF (M) connector of the RG8 Coaxial Cable, coming from the Antenna, to the terminal, marketed “Antenna” and located on the bottom of the PolyPhaser Surge Arrestor.

Step 14: See Figures H & K



Use a ring type lug, on the end of a #6 gauge or larger bare copper wire, connect it to the Ground Terminal on the PolyPhaser Surge Arrestor.

Step 15: See Figure H

Route the Ground Wire from the PolyPhaser Surge Arrestor through the exterior wall and connect it to one rod of the 3-rod grounding grid, using a brass ground rod clamp.

Step 16: See Figures G, H, K

Take the second 25'-0" RG8 Type Coaxial Cable and connect the UHF (M) connector to the terminal marked "Equipment" on the Polyphaser Surge Arrestor. Connect the UHF (M) connector on the other end of this cable to the Coaxial Cable coming from the Radio/Modem unit in the ICI+

Step 17: See Figures G, H, L

As close to the Central location as possible, install a 3-rod Earth Grounding Grid. A typical 3-rod grounding grid shall consist of three (3) – 5/8" diameter x 8'-0" long copper clad grounding rods. The rods shall be installed in a triangular arrangement, if at all possible. If it is impossible to arrange the rods in a triangular pattern then they may be arranged in a straight line (although NOT as effective) with each rod at least 8'0" from any other rod. Refer to Figure K.

NOTE: if rods longer than 8'0" are used, they should be spaced no closer than the length of the rod from each other.

The three (3) rods shall be driven into the ground with the top of rod at least six inches (6") below the finish grade. The rods should be tied together below grade with #6 gauge or larger bare copper wire. The wire shall be attached to the rod using a brass clamp. A separate brass clamp should be used for each attachment.

Any rod that has a ground wire connected to it, coming from a surge arrestor, or the equipment, or where an MGP-1 Grounding Plate Assembly is attached to it, should have a standard 12" x 18" rectangular valve box installed around the top of the rod. This should provide future access to inspect and/or maintain the MGP-1 grounding plate assembly, brass clamps and ground wires should this be necessary. Any of the other rods in the grid should have a standard 6" diameter round valve box and cover installed around the top of the rod for future access.

At the 3-rod grounding grid, it is recommended to maintain a ground resistance of 5 ohms or less, if at all possible. Anything above 15 ohms is of little value for protection. In order for the surge arrestors to be effective they must be able to discharge to ground rather than allow the surge to go to the electronic components of the equipment. Therefore, the HIGHER the resistance of the ground (higher ohm readings) the less change of the surge being shunted to ground rather than go to the electronic components. This is the reason it is also **IMPORTANT** to maintain a GOOD GROUND at all times.

When a grounding grid is first installed, it may not be possible to get a true ohm reading, since the rod surface will not be in good contact with the soil. The grid must be installed for 5-6 weeks before a meaningful reading can be obtained. It is also recommended that the grounds be



checked at least once a year, using a Meggar, Vibra-Ground or other type of measuring equipment. In severe lightening areas perhaps as often as 2-3 times a year may be more prudent.

Step 18: See Figures G, H, K, L

Run a #6 Gauge or larger bare copper wire from the grounding lug of the ICI+LINK out and connect it to one rod of the 3-rod grounding grid, using a brass clamp.

Step 19: See Figures K, L

Run a #6 Gauge or larger bare copper wire from the grounding terminal on the PolyPhaser Surge Arrestor out and connect it to one rod of the 3-rod grounding grid, using a brass clamp.

Step 20: See Figures H, I, L

Run a #6 Gauge or larger bare copper wire from the grounding lug that you installed on the Antenna mounting clamp, and connect it to one rod of the 3-rod grounding grid, using a brass clamp.

Step 21: See Figure G

The Green Ground Wire that is attached to one screw on the transformer housing of the ICI+LINK shall be extended over and connected to a screw on the cabinet of the computer. This then provides a common grounding path for both the computer and the ICI+LINK.

The installation of the ICI+LINK should now be complete!

Coaxial Cable Connection to ICI+LINK Module

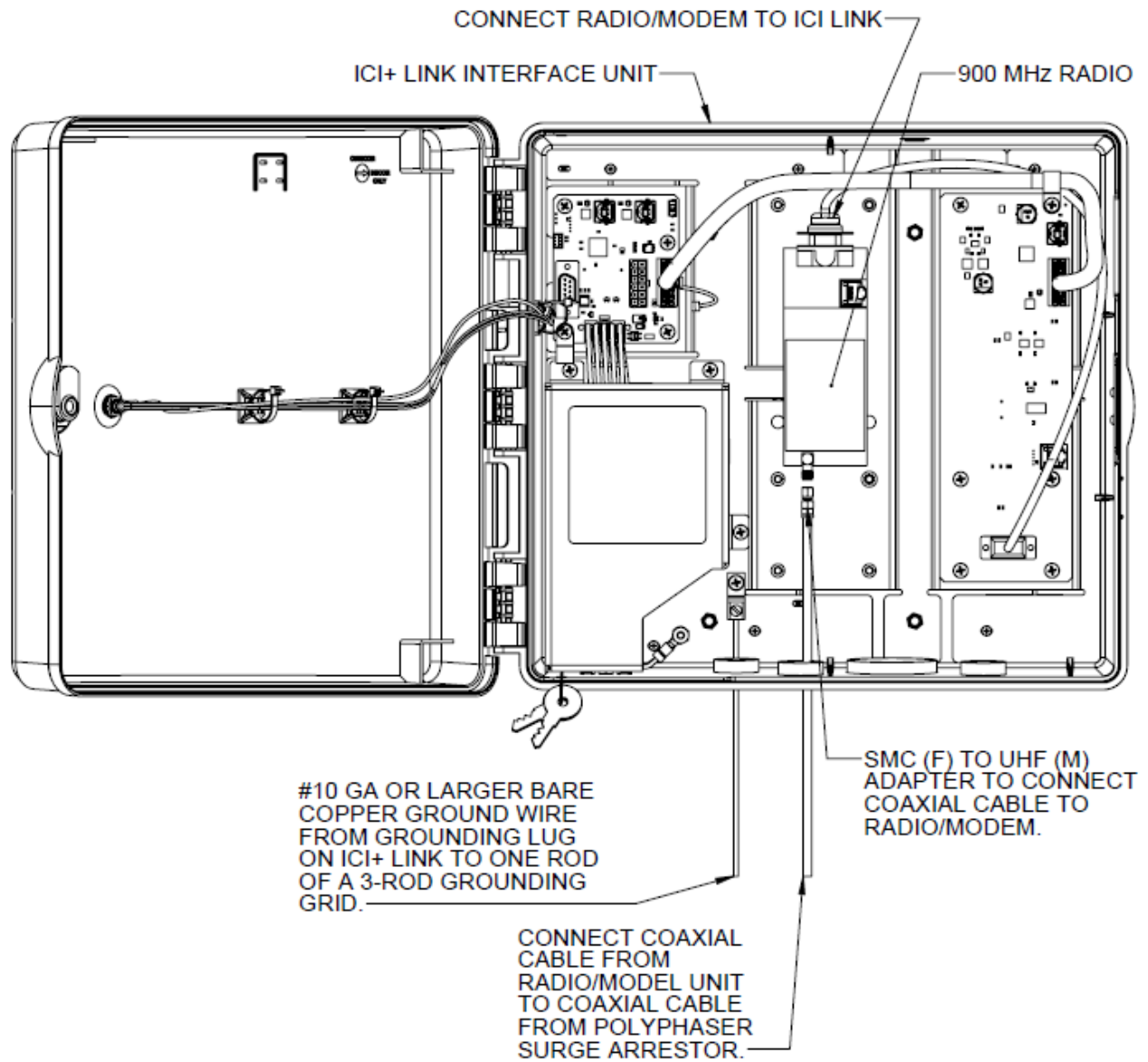

Figure G

LINK Radio Installation Detail for Base Antenna, Coaxial Cable & Grounding Wires

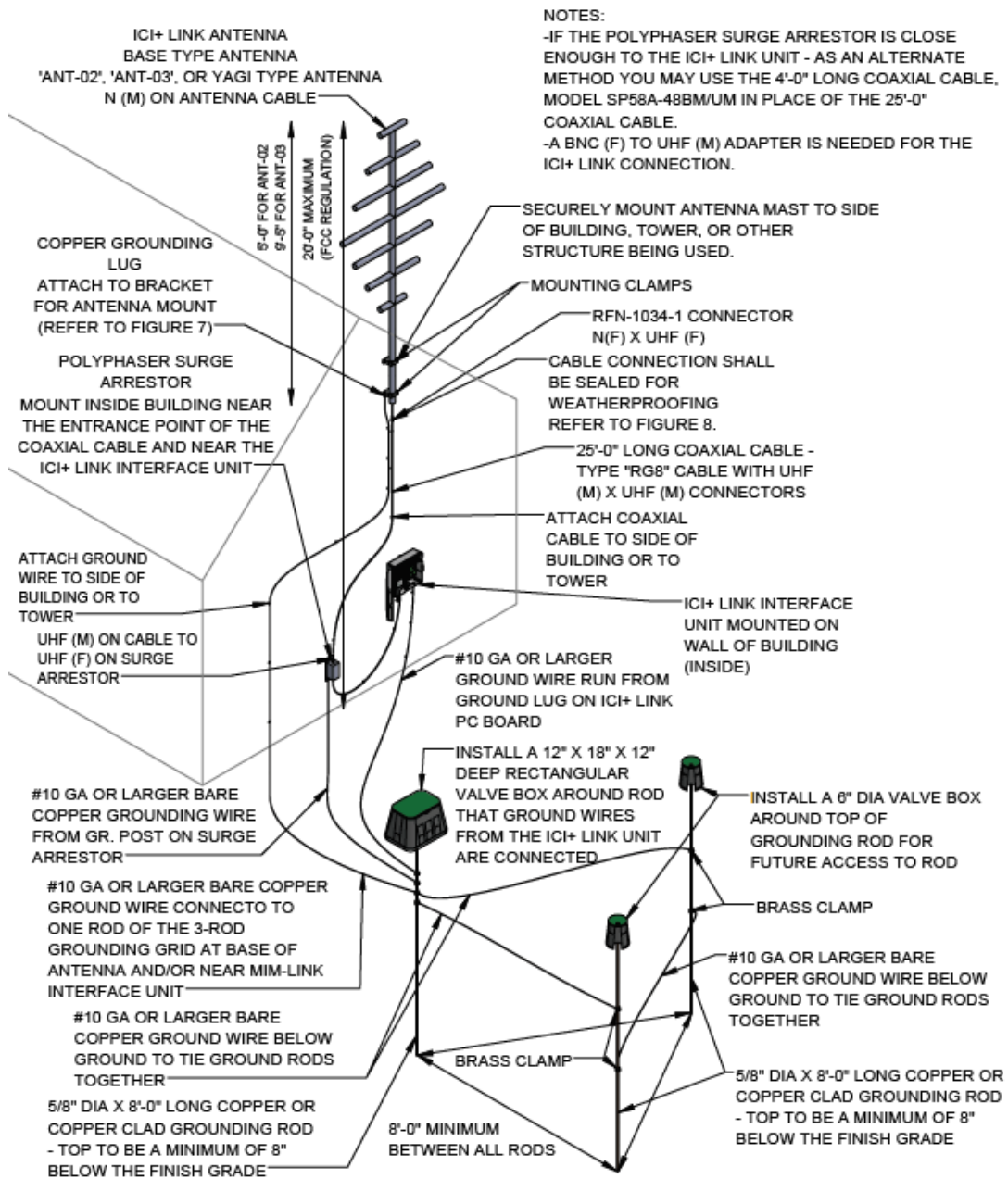

Figure H

Antenna Grounding Lug Mounting Detail

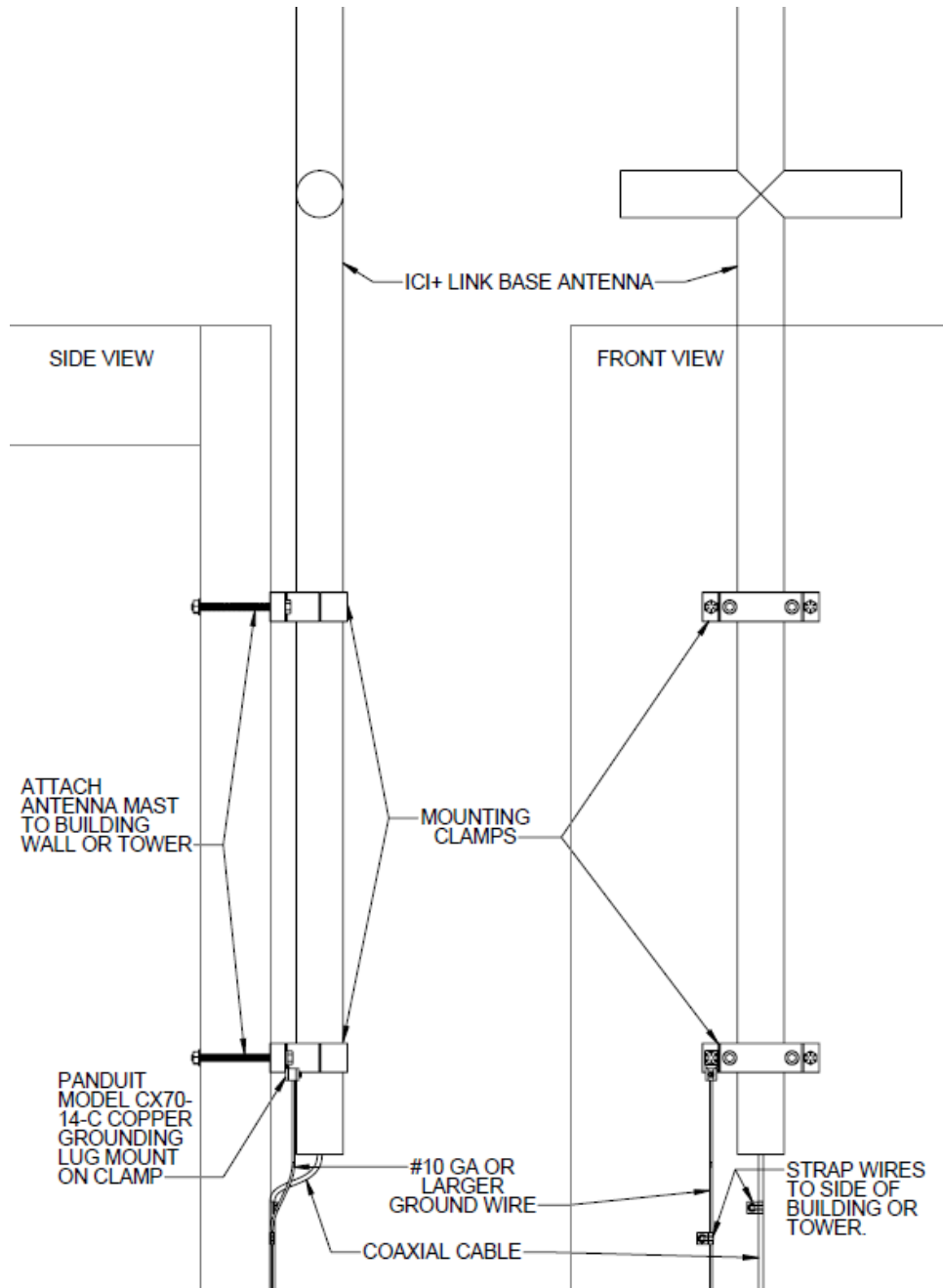
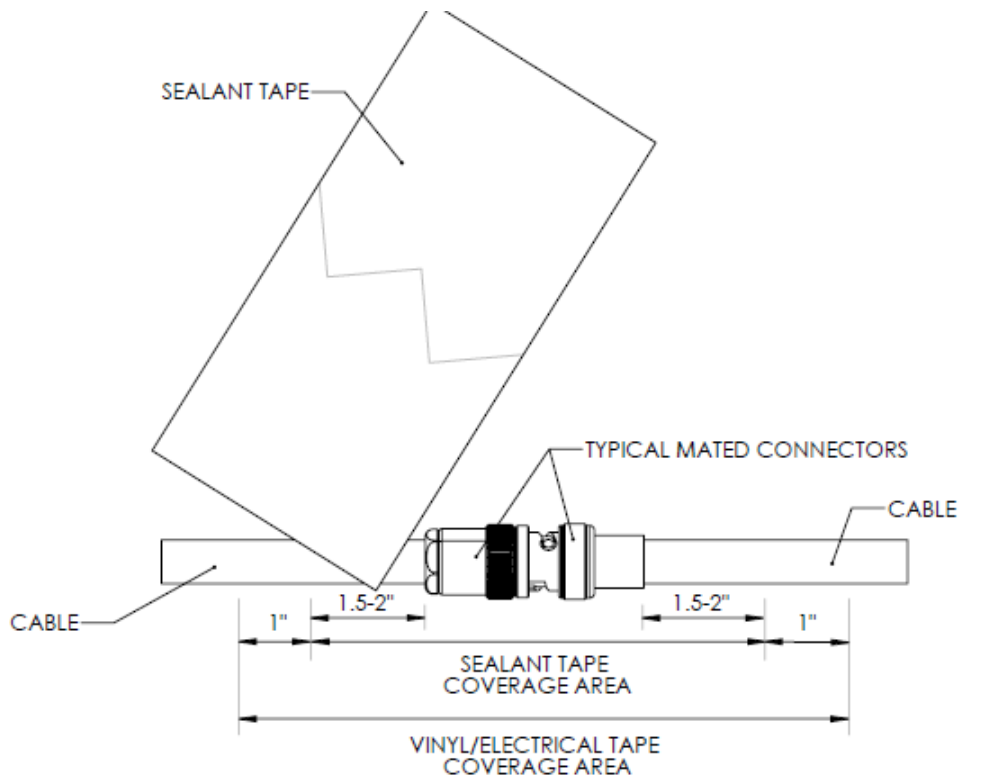

Figure I

Weatherproofing Coaxial Cable Connections



1. WRAP SEALANT TAPE OVER ENTIRE CONNECTION, OVERLAPPING HALF-WIDTH.

NOTE: STRETCH TO ELONGATE SEALANT TAPE WHILE WRAPPING OVER CONNECTION

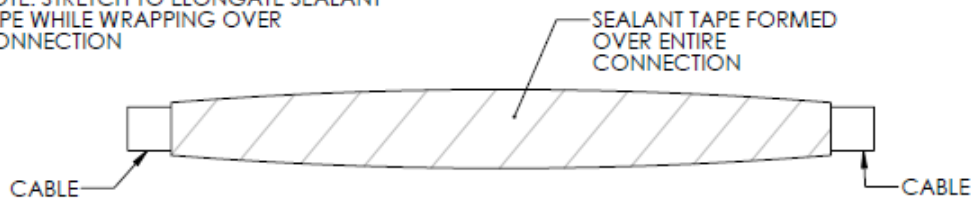

2. GENTLY PRESS ON THE SEALANT TAPE FORMING IT TO THE CONNECTION ITSELF AND THE CABLE JACKET.

Figure J

Mounting and Wiring of Polyphaser Surge Arrestor

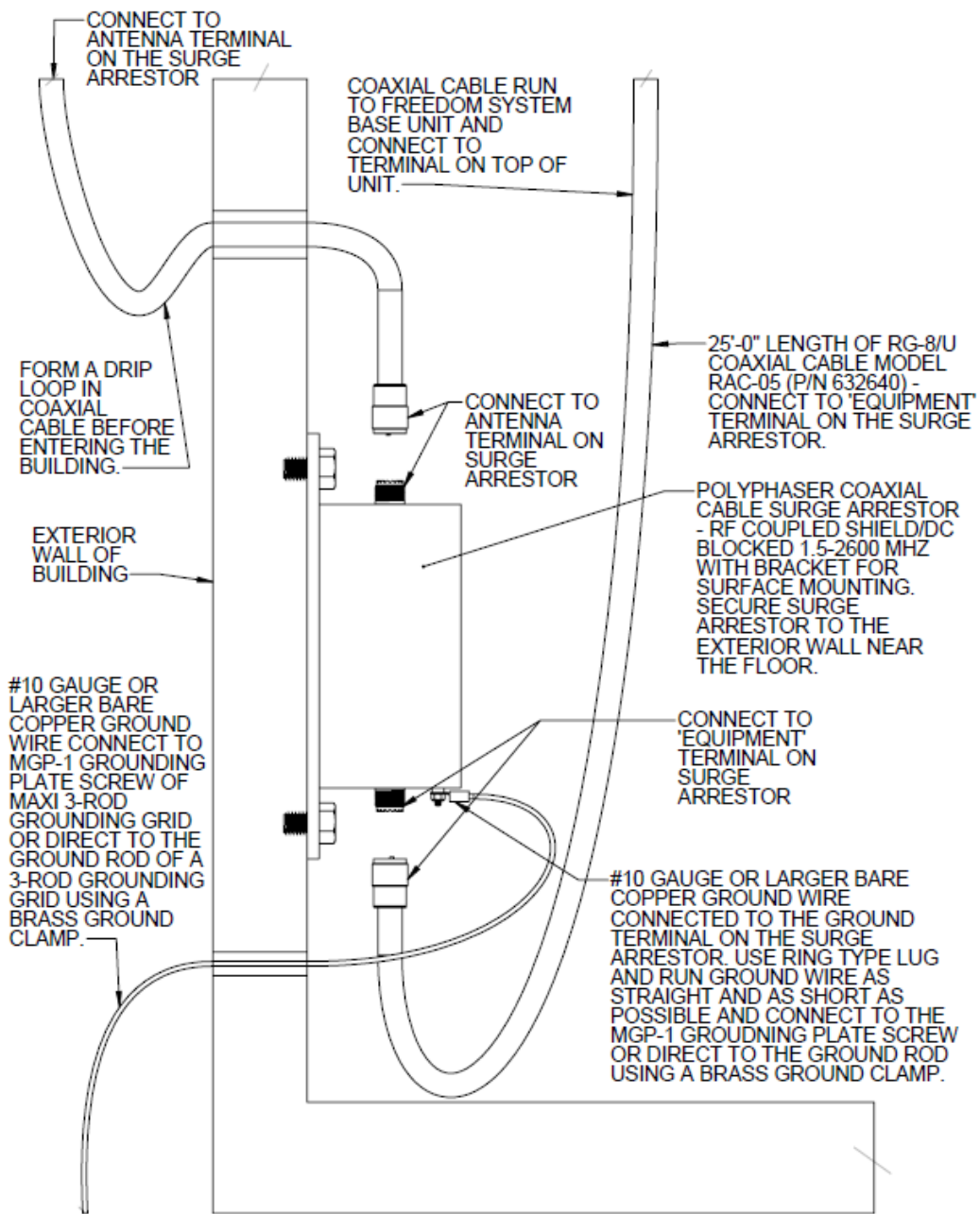

Figure K

Installation Detail for 3-Rod Grounding Gird at Central Location

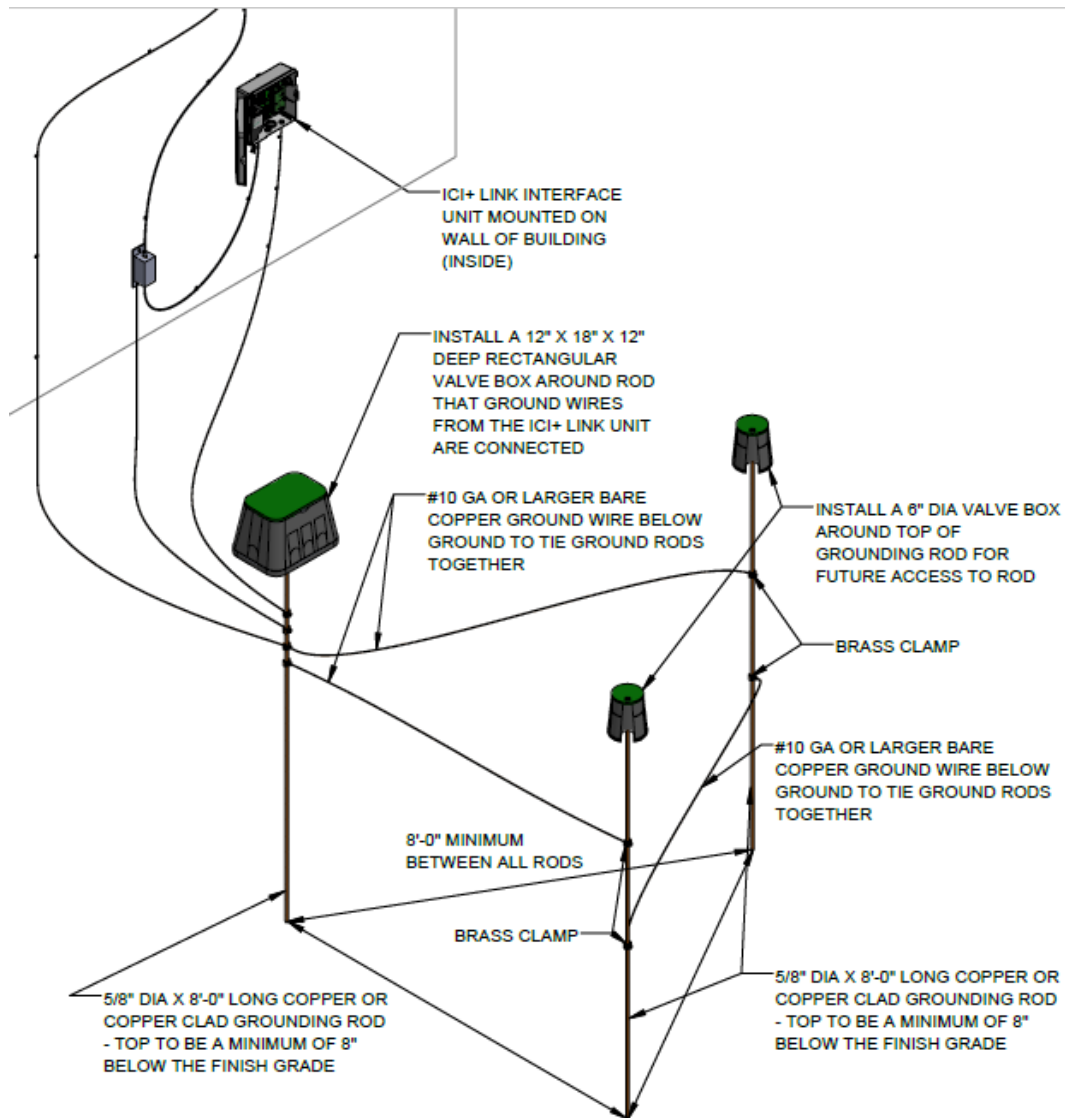

Figure L



ICI+ System Specifications

INDOOR INSTALLATION ONLY

| | |
|------------------------------|--|
| Operating Temperature: | 14°F to 125°F (-10°C to 51°C) |
| Storage Temperature: | -40°F to 150°F (-40°C to 65°C) |
| Operating Relative Humidity: | 75% max at 40°F to 108°F (4.4°C to 42°C) |
| Storage Relative Humidity: | 75% max at 40°F to 108°F (4.4°C to 42°C) |

Input Voltage Options

| | |
|---------------|-------------------------------|
| North America | 120VAC +/- 10% @ 60Hz +/- 2Hz |
| Japan | 100VAC +/- 10% @ 50Hz +/- 2Hz |
| International | 230VAC +/- 10% @ 50Hz +/- 2Hz |
| Australia | 240VAC +/- 10% @ 50Hz +/- 2Hz |

| | |
|----------------|-----------|
| Output Voltage | 26-29 VAC |
|----------------|-----------|