

# RAIN BIRD®

## ESP-LXIVM Series Controllers

### Field Device Installation Guide

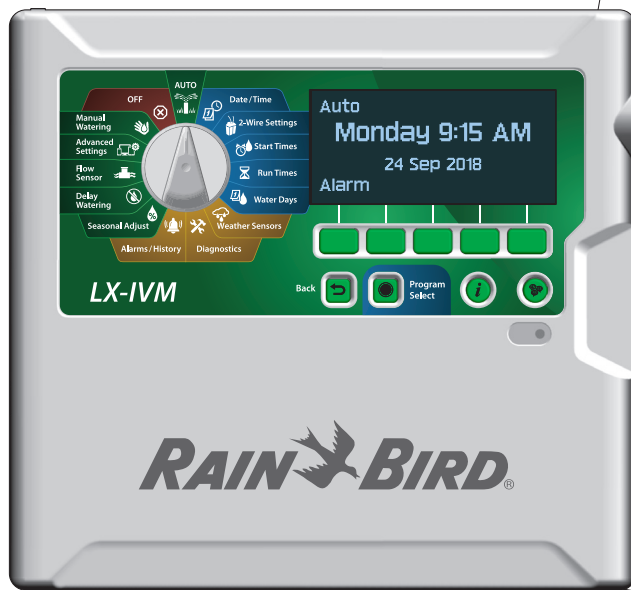

#### IVM-OUT (Output Device)

IVM-OUT 2-Wire control devices can be used to control valves with DC latching solenoids.

- 1 Connect the red and black wires on the IVM-OUT to the 2-Wire Path.
- 2 Connect the red/white striped wire on the IVM-OUT to the DC latching solenoid red wire.  
Connect the black/white striped wire on the IVM-OUT to the DC latching solenoid black wire.
- 3 For future troubleshooting or modifications, it is recommended to leave an additional 3 feet (1 meter) of 2-Wire cable stored in each valve box location.

NOTE: Make sure that the DC latching solenoid is compatible with non Rain Bird valves. Contact the valve manufacturer for more information.

#### NOTICE

Maximum combined wire length between IVM-OUT and its load (e.g. Solenoid) shall be 48 in. (1.2 m). This includes pre-installed IVM-OUT wire (24 in. (610 mm)) and solenoid wires (22 in. (559 mm)).

Use only WC20 splice kits for all wiring connections to the 2-Wire Path. Improper wiring can cause serious damage to your controller or irrigation system.

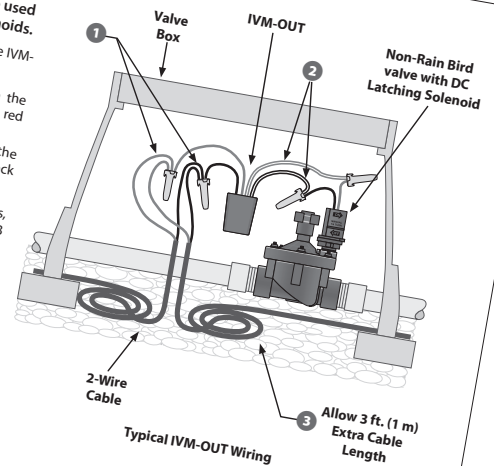

# Regulatory Information

## Federal Communications Commission

### Supplier's Declaration of Conformity

#### 47 CFR § 2.1077 Compliance Information

Unique Identifier:

**ESPLXIVM, ESPLXIVMP, LXIVMFP, LXIVMPFP, LXIVMSOL, LXIVMOUT, LXIVMSEN, LXIVMSD**

### Responsible Party – U.S. Contact Information

Rain Bird Corporation  
9491 Ridgehaven Court  
San Diego, CA 92123 USA

[www.rainbird.com](http://www.rainbird.com)

### FCC Compliance Statement

This device complies with part 15 of the FCC Rules. Operation is subject to the following two conditions: (1) This device may not cause harmful interference, and (2) this device must accept any interference received, including interference that may cause undesired operation.

Note: This equipment has been tested and found to comply with the limits for a Class B digital device, pursuant to part 15 of the FCC Rules. These limits are designed to provide reasonable protection against harmful interference in a residential installation. This equipment generates, uses and can radiate radio frequency energy and, if not installed and used in accordance with the instructions, may cause harmful interference to radio communications. However, there is no guarantee that interference will not occur in a particular installation. If this equipment does cause harmful interference to radio or television reception, which can be determined by turning the equipment off and on, the user is encouraged to try to correct the interference by one or more of the following measures:

- Reorient or relocate the receiving antenna.
- Increase the separation between the equipment and receiver.
- Connect the equipment into an outlet on a circuit different from that to which the receiver is connected.
- Consult the dealer or an experienced radio/TV technician for help.

### IC Canada Statement

The Class B apparatus meets all requirements of the Canadian ISED (formerly IC) regulations - CAN ICES-3 (B)/NMB-3 (B).

Cet appareil de classe B respecte toutes les exigences de la réglementation canadienne ISED (anciennement IC)- CAN ICES-3 (B)/NMB-3 (B).

### Waste Electrical and Electronic Equipment (WEEE)



As a hardware manufacturer, Rain Bird has met its national obligations to the EU WEEE Directive by registering in those countries to which Rain Bird is an importer. Rain Bird has also elected to join WEEE Compliance Schemes in some countries to help manage customer returns at end of life.

## Certifications

- cULus, CE, NOM, RCM, IRAM, INMETRO, NRCS, SABS, KC



DECLARATION OF CONFORMITY

Rain Bird Corporation hereby declares that the following irrigation controllers and accessories are CE compliant.

IESPLXIVM, IESPLXIVMP, ILXIVMEU, ILXIVMPEU, LXIVMSOL, LXIVMOUT, LXIVMSEN, LXIVMSD, LXIVMPFP\*, LXIVMFP\*, and LXIVM2WMOD\*
(\*Spare part sold separately - obtained compliance with the controller IESPLXIVM)

This declaration of conformity is issued under the sole responsibility of the manufacturer. The object of the declaration described above is in conformity with the relevant Union harmonization legislation, and the references to the relevant harmonized standards used or to other technical specifications in relation to which conformity is declared are listed below:

Electromagnetic Compatibility (EMC) Directive 2014/30/EU

- EN 55014-1:2006 + A2:2011
• EN 55014-2:1997 + A1:2001 + A2:2008

Low Voltage (LVD) Directive 2014/35/EU

- EN 60335-1:2012 + AC:2014 + A11:2014 + A13:2017 including
• IEC 60335-1:2010, and EN 62233:2008 + AC:2008
• IEC 60335-1 Edition 5.2: 2010 +A1: 2013 +A2: 2016

Restriction of the use of certain Hazardous Substances (RoHS) Directive 2011/65/EU

- EN 50581:2012

Place: San Diego, CA
Signature: [Handwritten Signature]
Full Name: Roger S. Neitzel
Position: Plant and Program Manager
Date: January 8, 2020

Rain Bird Corporation
970 W. Sierra Madre Ave.
Azusa, California 91702, USA
Phone: (626) 812-3400
Fax: (626) 812-3411

Rain Bird International, Inc.
1000 West Sierra Madre Ave.
Azusa, CA 91702, USA
Phone: (626) 963-9311
Fax: (626) 852-7343

Rain Bird Europe
240 Rue René Descartes – Le Clamar Bât. A
13290 Aix En Provence, France
Phone: (33) 4 42 24 44 61
Fax: (33) 4 42 24 24 72

© 2020 Rain Bird Corporation
® Registered Trademark of Rain Bird Corporation

P/N: 690865-01 REV. 08JA20

## Safety Information

### **⚠ WARNING**

Special precautions must be taken when valve wires (also known as station or solenoid wires) are located adjacent to, or share a conduit with other wires, such as those used for landscape lighting, other “low voltage” systems or other “high voltage” power.

Separate and insulate all conductors carefully, taking care not to damage wire insulation during installation. An electrical “short” (contact) between the valve wires and another power source can damage the controller and create a fire hazard.

All electrical connections and wiring runs must comply with local building codes. Some local codes require that only a licensed or certified electrician can install power. Only professional personnel should install the controller. Check your local building codes for guidance.

### **⚠ CAUTION**

This appliance is not intended for use by persons (including children) with reduced physical, sensory or mental capacity, or lack of experience and knowledge unless they have been given supervision or instruction concerning use of the appliance by a person responsible for their safety. Children should be supervised to ensure that they do not play with the appliance. Cleaning and user maintenance shall not be made by children without supervision.

If the supply cord of ILXIVMAU or ILXIVMAUP is damaged, it must be replaced by the manufacturer, its service agent or similarly qualified persons in order to avoid a hazard.

Replace with the following:  
Flexible supply cord H05VVF, minimum wire size of 0.75 mm<sup>2</sup> (18 AWG).  
For direct connection wiring:  
Minimum wiring size is 0.75 mm<sup>2</sup> (18 AWG).

For controllers not provided with a supply cord, the fixed installation must include a disconnecting device for all three poles suitable for overvoltage category III protection.

### **NOTICE**

Use only Rain Bird approved accessory devices. Changes or modifications not expressly approved by Rain Bird could void the user’s authority to operate the equipment. Unapproved devices may damage the controller and void the warranty. For a list of compatible devices go to: [www.rainbird.com](http://www.rainbird.com)

Date and time are retained by a lithium battery which must be disposed of in accordance with local regulations.

Model, serial number, supply rate and fabrication date are located on the back of swing panel.

Power supply for countries with 120V  
Input: 120 V ac 60 Hz 0.5A  
Output: 26.5 V ac 60 Hz 1.9A`



# ESP-LXIVM Series Controllers

## Field Device Installation Guide

<b>2-Wire Device Field Connections .....</b>	<b>6</b>
<b>Gather Installation Tools .....</b>	<b>6</b>
<b>Wiring Connections .....</b>	<b>6</b>
<b>Outdoor Installation with Direct Wiring.....</b>	<b>6</b>
<b>Field Wiring Connections .....</b>	<b>7</b>
Connect devices to the 2-Wire path. ....	7
<b>Installation .....</b>	<b>8</b>
<b>2-Wire Address Labels .....</b>	<b>8</b>
<b>IVM-SOL Installation .....</b>	<b>9</b>
Connect IVM-SOL to a Valve .....	10
Connect IVM-SOL to a Master Valve .....	10
<b>IVM-OUT (Output Device).....</b>	<b>11</b>
<b>IVM-SEN (Sensor Device) .....</b>	<b>12</b>
Connect Weather Sensors .....	12
<b>IVM-SD (Surge Device).....</b>	<b>13</b>
<b>Pump Start Relay.....</b>	<b>14</b>
<b>Connect 2-Wire (MAXI Cable) From Field Devices .....</b>	<b>15</b>
<b>Connect Local Weather Sensors.....</b>	<b>15</b>

## 2-Wire Device Field Connections

### Gather Installation Tools

Before beginning installation, gather together the following tools and materials:

- Lineman's pliers
- #14 AWG MAXI Cable bare ground wire
- WC20 waterproof wire connectors and wire nuts (provided)
- Rain Bird® 2-Wire stripper

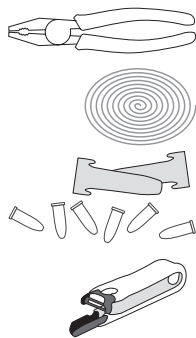

### Wiring Connections

#### Outdoor Installation with Direct Wiring

#### **⚠ WARNING**

Electric shock can cause severe injury or death. Make sure power supply is turned OFF before connecting power wires.

Ground wire must be connected to provide electrical surge protection. Permanently mounted conduit shall be used for connecting main voltage to the controller.

Do not route valve wires through the same opening as power wires.

#### Wiring Connections

120 VAC (US)	230 VAC (International)
Black supply wire (hot) to the black transformer wire	Brown supply wire (hot) to the brown transformer wire
White supply wire (neutral) to the white transformer wire	Blue supply wire (neutral) to the blue transformer wire
Green supply wire (ground) to the green transformer wire	Green-with-yellow-stripe supply wire (ground) to the green-with-yellow-stripe transformer wire

- 1** Route the three external power source wires through the conduit opening at the bottom of the unit and into the wiring compartment.
- 2** Using the provided wire nuts, connect the external power source wires (two power and one ground) to the transformer connection wires inside the wiring compartment.

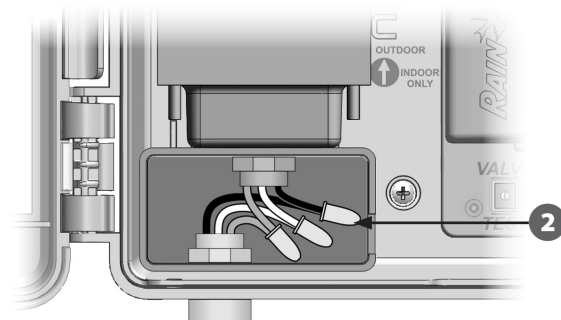

## Field Wiring Connections

### Connect devices to the 2-Wire path.

It is recommended to use the Rain Bird 2-Wire Stripper tool to remove the outer MAXI Cable jacket without damaging the inner insulation.



 NOTE: To avoid damaging the wiring, tools such as utility, pocket, carpet, box cutter knives or Romex strippers should not be used to strip wires.

### NOTICE

Rain Bird requires the use of 14 gauge AWG MAXI Cable (double-jacketed, 2-Wire conductor).

Always place 2-Wire Devices and connections inside a valve box. Assure that the wiring copper conductors are not exposed after installation.

- 1 Carefully score approximately 6 in (15,24 cm) of the AWG MAXI Cable's outer jacket. Gently flex the cable to expose the portion to be removed and to reveal the 2 inner wires. Then trim away the excess of the outer jacket.

 NOTE: It may be necessary to remove the outer jacket in two or more sections.

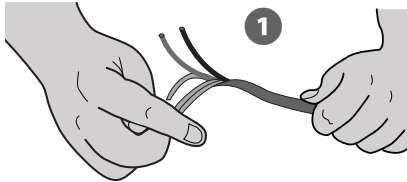

- 2 Strip away approximately 5/8 in (1,58 cm) of insulation from the ends of the two inner wires.

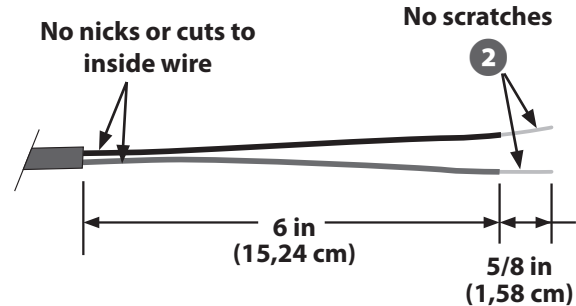

- 3 Remove the pre-cut insulation from the ends of the wires on the 2-Wire device. Connect the device wires to the 2-Wire path using linesman's pliers to twist the ends together.



### NOTICE

Wire colors must be paired red to red and black to black in order to maintain polarity when completing wire splices.

- 4 Insert the connected wires into the provided wire-nuts and twist to secure.
- 5 Insert the wire-nut all the way into the WC20 connector. Position wires on side of the connector as shown and then snap the cap shut.

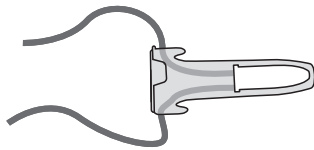
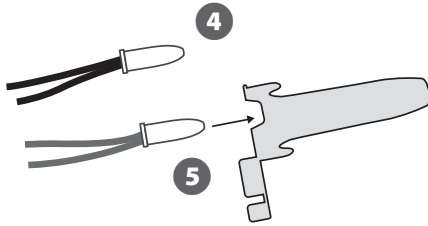

**Completed Wire Splice**



Scan the QR code to see a video on how to make 2-Wire cable connections.



## Installation

### 2-Wire Address Labels

**Before installing the 2-Wire Device, apply your 2-Wire Device barcode labels to the appropriate fields on the Programming Guide.**

-  NOTE: See the ESP-LXIVM Programming Guide that came with your controller.
- 1 Carefully peel off the station, master valve, flow or weather sensor device barcode label.
- 2 Apply the 2-Wire Device address labels in the appropriate fields on the Programming Guide.
-  NOTE: Do not remove the label from the carrier attached to the wire.

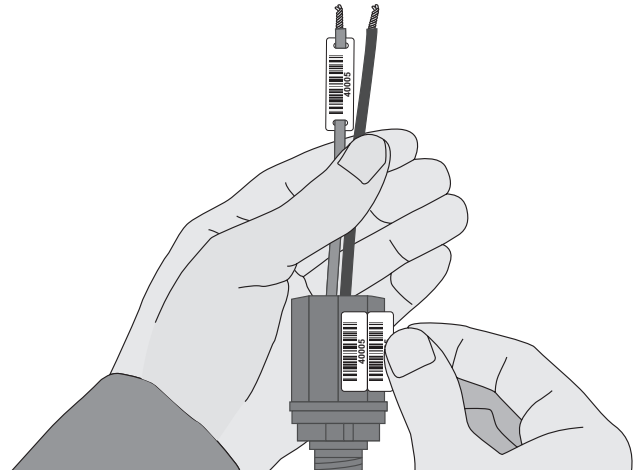



## IVM-SOL Installation

- 1 Use pressure sprayer to clean equipment.
- 2 Check that O-rings are free from damage or debris.
- 3 Attach IVM-SOL hand-tight (with no water pressure).

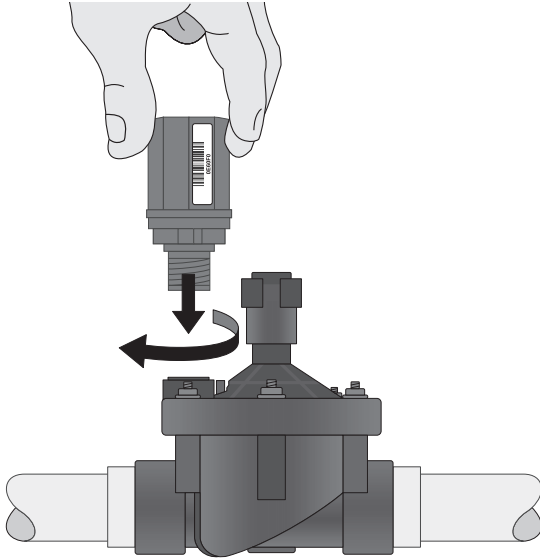

 NOTE: It's normal to hear a brief ratcheting sound during installation of the IVM-SOL on a valve.

## Connect IVM-SOL to a Valve

- 1 Connect the red and black wires on the IVM-SOL to the 2-Wire Path.
- 2 For future troubleshooting or modifications, it is recommended to leave an additional 3 feet (1 meter) of 2-Wire cable stored in each valve box location.



NOTE: If the valve is NOT at the end of the 2-Wire Path then make a three-way splice; the red wire from the valve module to the two red wires of the 2-Wire Path; then splice the valve module black wire to the two black wires of the 2-Wire Path.

### NOTICE

Use only WC20 splice kits for all wiring connections to the 2-Wire Path. Improper wiring can cause serious damage to your controller or irrigation system.

## Connect IVM-SOL to a Master Valve

Up to 5 master valves can be connected to the 2-Wire path of the ESP-LXIVM controller and up to 10 master valves for the LX-IVM Pro controller. IVM-SOL can be used for both station and master valves. Master valves are connected using the same processes as described previously.



NOTE: Be sure to attach the barcode labels to the Programming Guide as a Master Valve instead of a Station.

### NOTICE

If retro-fitting, do not use TBOS (Battery Operated System) solenoids or decoders in the ESP-LXIVM system.

Ensure that all decoders are disconnected from the 2-Wire path.

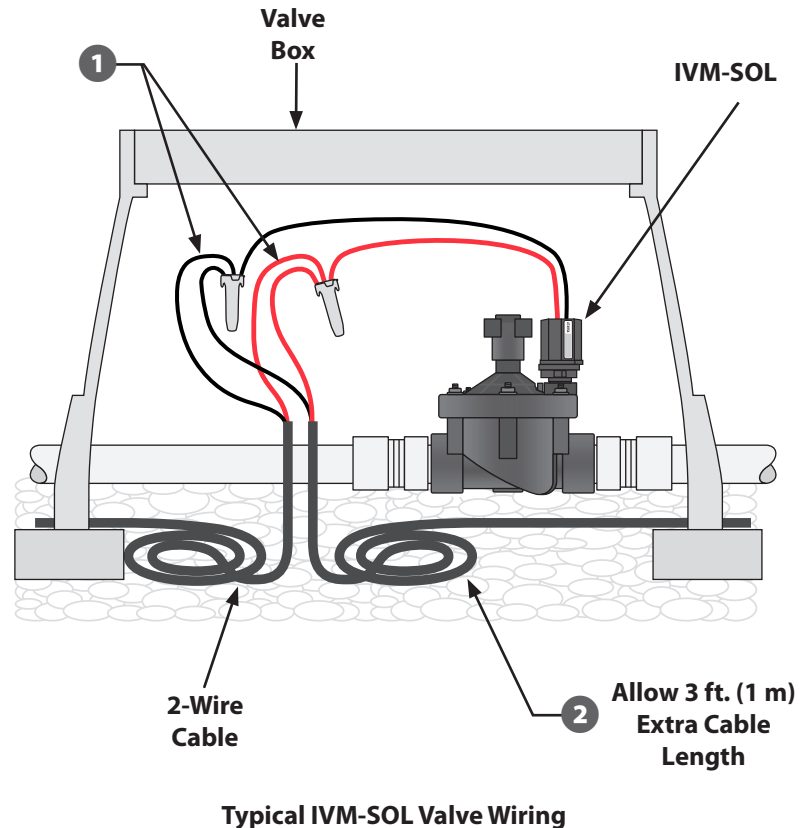

## IVM-OUT (Output Device)

IVM-OUT 2-Wire control devices can be used to control valves with DC latching solenoids.

- 1 Connect the red and black wires on the IVM-OUT to the 2-Wire Path.
- 2 Connect the red/white striped wire on the IVM-OUT to the DC latching solenoid red wire.  
Connect the black/white striped wire on the IVM-OUT to the DC latching solenoid black wire.
- 3 For future troubleshooting or modifications, it is recommended to leave an additional 3 feet (1 meter) of 2-Wire cable stored in each valve box location.



NOTE: Make sure that the DC latching solenoid is compatible with non Rain Bird valves. Contact the valve manufacturer for more information.

### NOTICE

Maximum combined wire length between IVM-OUT and its load (e.g. Solenoid) shall be 48 in. This includes pre-installed IVM-OUT wire (24 in.) and solenoid wires (22 in.).

Use only WC20 splice kits for all wiring connections to the 2-Wire Path. Improper wiring can cause serious damage to your controller or irrigation system.

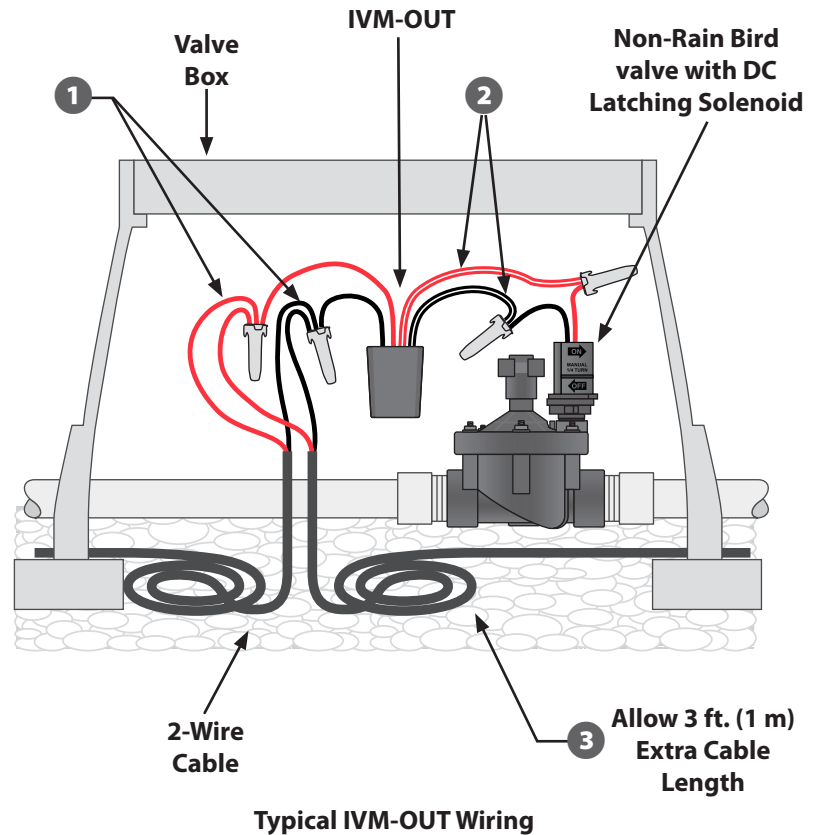

## IVM-SEN (Sensor Device)

### Flow sensors are connected to the 2-Wire Path via IVM-SEN 2-Wire devices.

The ESP-LXIVM controller can support up to 5 flow sensors and the LX-IVM Pro controller can support up to 10 flow sensors.

### Connect Flow Sensors

- 1 Install flow sensors into your irrigation piping system at each point of connection to the water supply (water meter or pump).

#### NOTICE

For optimum performance and flow sensing, flow sensors should be installed a minimum of 10 pipe diameters in length on the upstream (supply) side and a least 5 pipe diameters in length on the downstream (delivery) side before making any transitions in pipe size/direction or away from the master valve.

- 2 Connect the red and black wires on the IVM-SEN to the 2-Wire Path.
- 3 Connect the red/white striped wire on IVM-SEN to the flow sensor red wire  
Connect the black/white striped wire on IVM-SEN to the flow sensor black wire.



NOTE: Be sure to follow all instructions included with the flow sensor.

- 4 For future troubleshooting or modifications, it is recommended to leave an additional 3 feet (1 meter) of 2-Wire cable stored in each valve box location.

#### NOTICE

Use only WC20 splice kits for all wiring connections to the 2-Wire Path. Improper wiring can cause serious damage to your controller or irrigation system.

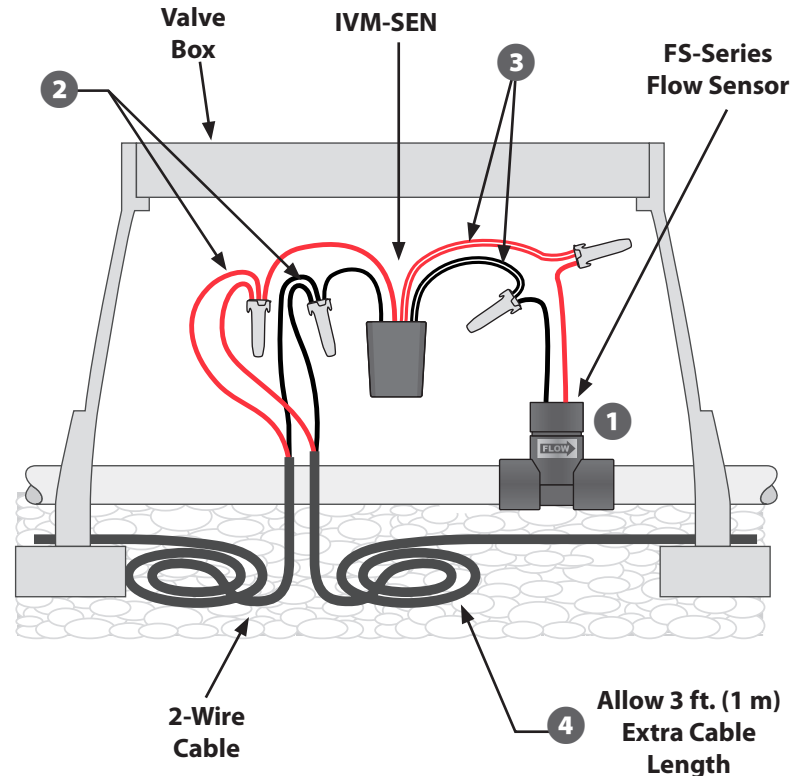

Typical IVM-SEN Flow Sensor Wiring

### Connect Weather Sensors

In addition to flow sensors, the LX-IVM can also support three weather sensors connected to the 2-Wire Path via an IVM-SEN. The LX-IVM Pro controller supports seven 2-Wire Path weather sensors. Weather sensors are connected to the LX-IVM Sensor input in the same way as the flow sensor.

## IVM-SD (Surge Device)

The IVM-SD provides surge protection for the ESP-LXIVM controller and the 2-Wire path.

The ESP-LXIVM controller and the 2-Wire path must be properly surge protected and grounded. Doing so can help prevent damage to the controller and irrigation system and also significantly reduce troubleshooting, repair time and expense. Failure to do so could result in failure of your controller and voiding the warranty.

- 1 Connect the red and black wires on the IVM-SD to the 2-Wire Path
- 2 Connect the green wires from the IVM-SD to the grounding rod or plate
- 3 For future troubleshooting or modifications, it is recommended to leave an additional 3 feet of 2-Wire cable stores in each valve box location.

### NOTICE

Use only WC20 splice kits for all wiring connections to the 2-Wire Path. Improper wiring can cause serious damage to your controller or irrigation system.

One IVM-SD is required every 500 feet or every 15 field devices.

IVM-SD shall also be spliced into each 2-Wire Path immediately next to the controller and at the termination of each wire path.

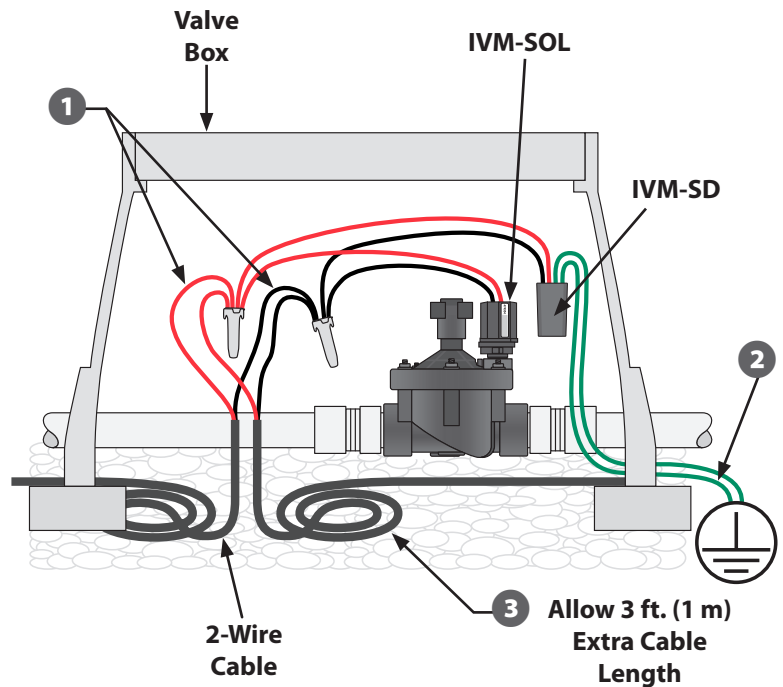

Typical IVM-SD Wiring

## Pump Start Relay

IVM-OUT 2-Wire Control Devices can control pump start relays that have a DC latching input coil.

- 1 Connect the red IVM-OUT wire to the red wire on the 2-Wire path. Then connect the black IVM-OUT wire to the black wire on the 2-Wire path.
- 2 Connect the red and white IVM-OUT wire to the red wire of the DC Latching Relay. Connect the black and white IVM-OUT wire to the black wire of the DC Latching Relay.
- 3 Follow your Pump Start Relay wiring instructions to connect input power and pump.
- 4 For future troubleshooting or modifications, it is recommended to leave an additional 3 feet (1 meter) of 2-Wire cable stored in each valve box location.

### NOTICE

Use only WC20 splice kits for all wiring connections to the 2-Wire Path. Improper wiring can cause serious damage to your controller or irrigation system and work must be performed by licensed electrician.

### WARNING

All electrical connections and wiring runs must comply with local building codes. Some local codes require that only a licensed or certified electrician can install power. Only professional personnel should install the controller. Check your local building codes for guidance.

**Pump Start with DC Latching Relay**  
Model Nos. PSR110-IVM and PSR220-IVM

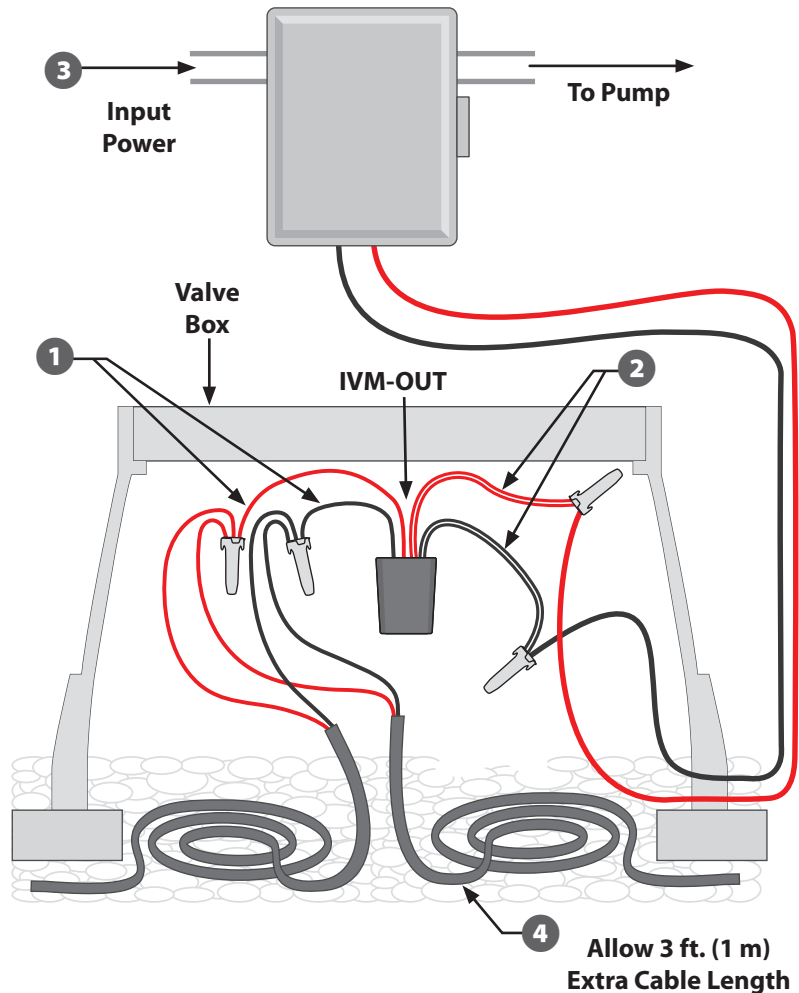

**Typical IVM-OUT Pump Start Relay Wiring**

## Connect 2-Wire (MAXI Cable) From Field Devices

You can connect up to 4 pairs of 2 -Wires (MAXI Cable) from the field devices back to the ESP-LXIVM controller.

 NOTE: Make sure the screws are all unscrewed all the way out (while remaining in the module)

- 1 Connect the Red Wire from the MAXI Cable to the Terminal with "R" marking
- 2 Connect the Black Wire from the MAXI Cable to the Terminal with "B" marking
- 3 Tighten the screw

 NOTE: The four pair of wires can be either in a Star pattern or a Loop pattern. For details refer to the 2-Wire Path overview section in the ESP-LXIVM user manual.

## Connect Local Weather Sensors

ESP-LXIVM can also accept input from a single weather sensor wired directly in to the controller.

 NOTE: Follow the sensor manufacturer's instructions to correctly install and make wire connections to the sensor.

- 4 Run continuous sensor wires from the weather sensor to the ESP-LXIVM controller.
- 5 Remove the yellow jumper wire (if present). Connect the sensor wires to the sensor (Sen) and common (C) inputs.

### NOTICE

Do not remove the yellow jumper wire unless collecting a rain sensor.

 NOTE: Ensure that the configuration for your controller and irrigation programs are set up correctly for your sensor.

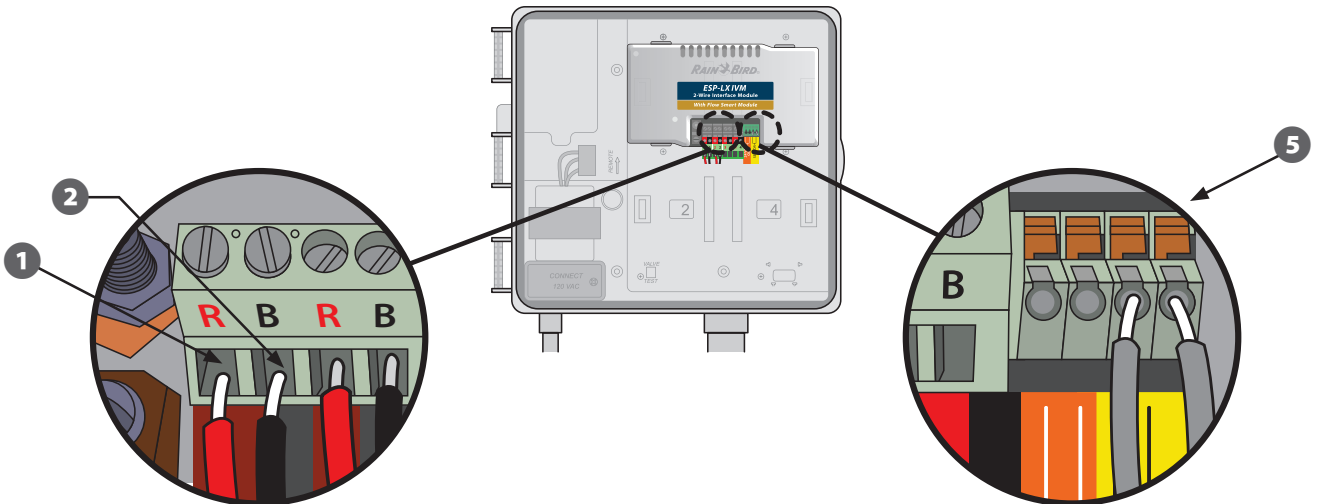



**Rain Bird Corporation**  
6991 East Southpoint Road  
Tucson, AZ 85756  
USA  
Tel: (520) 741-6100

**Rain Bird Corporation**  
970 W. Sierra Madre Ave.  
Azusa, CA 91702  
USA  
Tel: (626) 812-3400

**Rain Bird International**  
1000 W. Sierra Madre Ave.  
Azusa, CA 91702  
USA  
Tel: +1 (626) 963-9311

**Rain Bird Turkey**  
Çamlık Mh. Dinç Sokak Sk. No.4 D:59-60  
34760 Ümraniye, İstanbul  
TÜRKİYE  
Tel: (90) 216 443 75 23  
rbt@rainbird.eu  
www.rainbird.com.tr

**Rain Bird Europe SNC**  
**Rain Bird France SNC**  
240 rue René Descartes  
Bâtiment A, Parc Le Clamar  
BP 40072  
13792 AIX-EN-PROVENCE CEDEX 3  
FRANCE  
Tel: (33) 4 42 24 44 61  
rbe@rainbird.eu · www.rainbird.eu  
rbf@rainbird.eu · www.rainbird.fr

**Rain Bird Deutschland GmbH**  
Königstraße 10c  
70173 Stuttgart  
DEUTSCHLAND  
Tel: +49 (0) 711 222 54 158  
rbd@rainbird.eu

**Rain Bird Ibérica S.A.**  
C/ Valentín Beato, 22 2ª Izq. fdo  
28037 Madrid  
ESPAÑA  
Tel: (34) 91 632 48 10  
rbib@rainbird.eu · www.rainbird.es  
portugal@rainbird.eu  
www.rainbird.pt

**Rain Bird Australia Pty Ltd.**  
Unit 13, Level1  
85 Mt Derrimut Road  
PO Box 183  
Deer Park, VIC 3023  
Tel: 1800 724 624  
info@rainbird.com.au  
www.rainbird.com/au

**Rain Bird Brasil Ltda.**  
Rua Marques Póvoa, 215  
Bairro Osvaldo Rezende  
Uberlândia, MG, Brasil  
CEP 38.400-438  
Tel: 55 (34) 3221-8210  
www.rainbird.com.br

## Technical Support

### Questions?

Call Rain Bird toll free Technical Support  
at **1-866-544-1406**  
(USA and Canada only)

Find the full ESP-LXIVM user manual  
and trouble shooting information at  
**www.rainbird.com**