

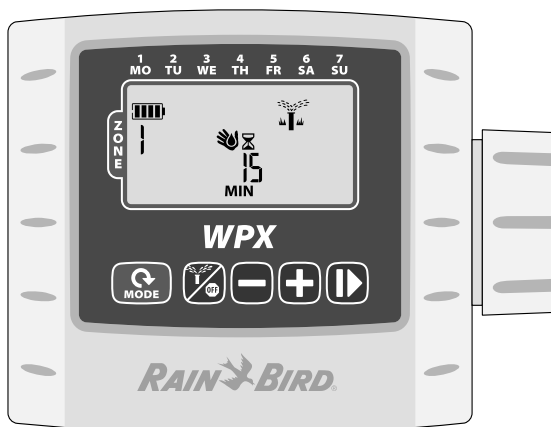

WPX Battery-Operated Controller



User Manual - Table of Contents

Controls and Indicators.....	2	Special Features.....	5
Operating Modes.....	2	Delay Watering	5
Introduction	2	Contractor Default Save.....	5
Operation and Setup.....	2	Contractor Default Restore.....	5
Contractor Rapid Programming™	2	Factory Default Restore	5
Set Date & Time	2	Rain Sensor Bypass	5
Set Irrigation Schedule	3	Installation	5
Select Zone.....	3	Valve Wiring	5
Set Zone Watering Run Times.....	3	Batteries	6
Set Zone Watering Start Times	3	Replacing Batteries.....	6
Set Zone Watering Days.....	3	Optional Rain Sensor	6
Custom Days	3	Troubleshooting.....	7
Watering Day Options	3		
Cyclic Days.....	3		
Odd Days / Even Days	4		
Auto Run	4		
Off	4		
Manual Watering	4		
One-touch Manual Start	4		
Seasonal Adjust	4		

Controls and Indicators

Operating Modes

- **Set Date & Time** - Set the current Date and Time of day (select 12 hour or 24 hour format).
- **Set Irrigation Schedule** - Edit customized irrigation schedules that run automatically.
- **Seasonal Adjust** - Increase or decrease watering duration (Run Times) by a percentage for all Zones.
- **Auto Run** - Watering occurs automatically according to programmed irrigation schedules.

Manual Watering / Off

- **Manual Watering** - Start watering immediately for ALL Zones or for any ONE Zone.
- **Off** - Stops any active watering and disables automatic irrigation.

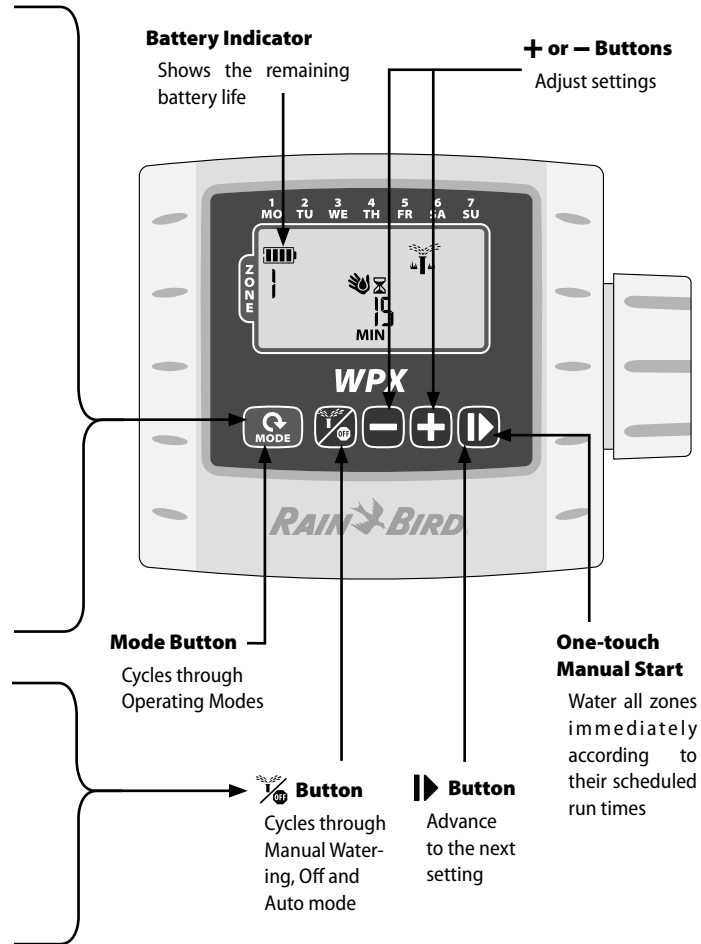
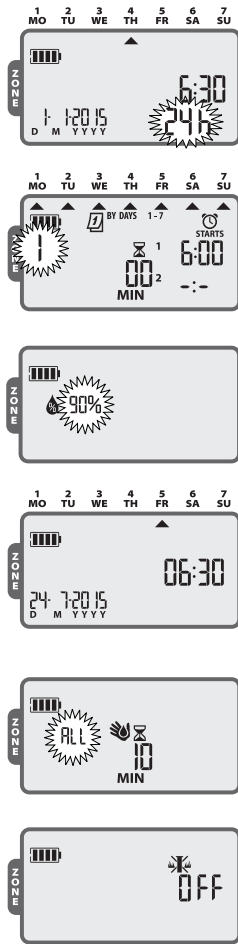

Introduction

Thank you for choosing Rain Bird's WPX Battery-Operated Controller. The WPX is designed to provide worry-free automatic irrigation in the absence of AC power or in areas where installing new field wires is not practical.

Operation and Setup

Contractor Rapid Programming™

At initial programming, the controller automatically copies the start times and watering days from Zone 1 to all other zones.

- ! **NOTE:** If multiple zones have the same or overlapping watering times, the controller will water the zones in sequence (multiple zones will not run at the same time).
- ! **NOTE:** Changes to a zone's schedule made after initial programming will only affect the zone being modified.
- ! **NOTE:** You may re-activate the Contractor Rapid Programming™ feature by resetting factory defaults (see page 5).

Set Date & Time

Press the **MODE** button until the **Set Date & Time** screen is displayed.

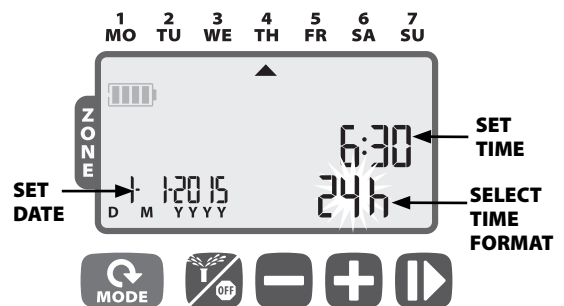

- ▶ Press **+ or -** to set the time format (12 hour or 24 hour); then press **▶▶**
- ▶ Press **+ or -** to set the hour (ensure that AM/PM setting is correct when using 12 hour format); then press **▶▶** to set the minutes; then press **▶▶**
- ▶ Press **+ or -** to set the year (YYYY); then press **▶▶** to set the day (D), then month (M). If 12 hour format is selected, the date format will be shown as M/D/YYYY.

Set Irrigation Schedule

Press the **MODE** button until the **Set Irrigation Schedule** screen is displayed.

1 Select Zone

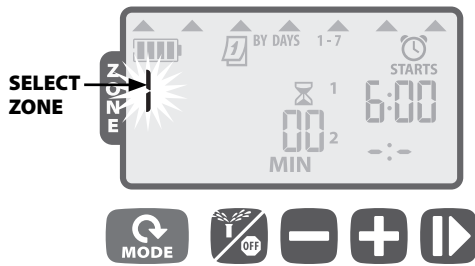

- ▶ Press **+** or **-** to select the Zone Number; then press **▶**

2 Set Zone Watering Run Times

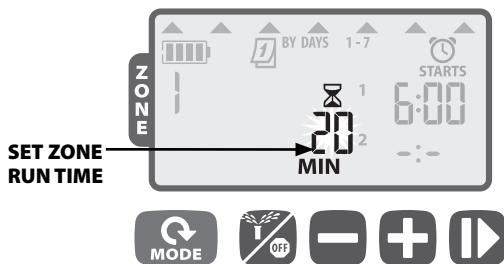

- ▶ Press **+** or **-** to set the Run Time (in minutes); then press **▶**

NOTE: Run Times can be set between 1 to 240 minutes.

3 Set Zone Watering Start Times

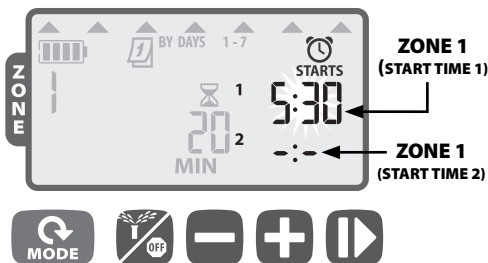

- ▶ Press **+** or **-** to set the 1st Start Time for the selected Zone (set to 06:00 by default); then press **▶**
- ▶ Press **+** or **-** to set the next Start Time, or press **▶** again to advance to Set Watering Days.

REPEAT to set additional Start Times, up to six for that Zone.

NOTE: Adjustments are set in 10 minute increments.

NOTE: To remove a Start Time, press **+** or **-** until **-:-** (OFF) is displayed. (**-:-** is just before 0:00 or 12:00 AM.)

NOTE: The controller will not water multiple zones at the same time. If two or more zones have the same (or overlapping) start times, the controller will wait until the first zone is finished watering before starting the rest of the zones in sequence. This method is called "start time stacking".

4 Set Zone Watering Days

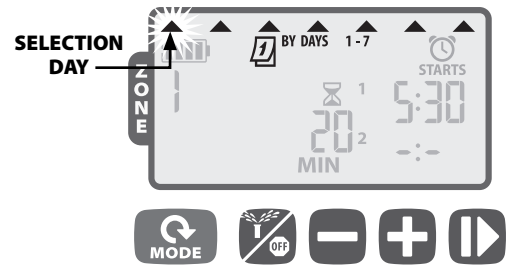

Custom Days

- ▶ Press **+** (to enable) or **-** (to disable) the blinking Selection Day. The cursor will automatically advance to the next Selection Day.



REPEAT to set each day of the week as desired.

REPEAT Steps 1-4 for additional Zones as desired.

- ▶ When programming is complete, press the **MODE** button until the **AUTO RUN** screen is displayed.

Watering Day Options

Additional Watering Day options are also available:

- **Cyclic Days** (1-30)
- **Odd Days** (Will NOT water on the 31st of the month)
- **Even Days**

To change a zone's watering day type, simply press the **+** and **-** buttons at the same time while setting Zone Watering Days.

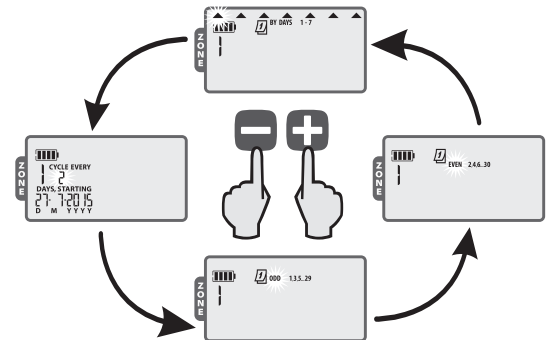

Cyclic Days

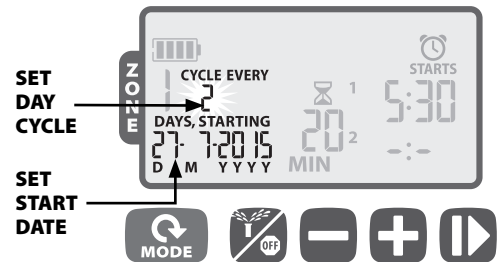

- ▶ Press **+** or **-** button to set the number of days in the watering cycle; then press **▶**

- ▶ Press **+** or **-** to set the next Watering Day; then press **▶**

Odd Days / Even Days

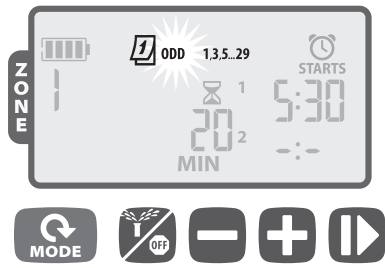

▶ When **ODD 1,3,5...29** (or **EVEN 2,4,6...30**) is blinking, press **▶**

! **NOTE:** ODD schedules will not water on the 31st of the month.

Auto Run

Press the MODE button until the AUTO RUN screen is displayed.

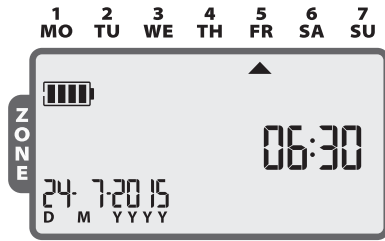

In **AUTO RUN** mode, the WPX will irrigate each zone per its programmed schedule. If any zones are scheduled to run at the same time and day, your controller will place those zones in a queue and irrigate one valve at a time, starting with the lowered number zone first.

! **NOTE:** After 5 minutes of inactivity, the controller will revert to **AUTO RUN** mode (unless the controller is in **OFF**) and turn off the display. Press any key to turn the display back on.

Off

Press the OFF button until the OFF screen is displayed.



Selecting the **OFF** mode will cancel any active watering and prevent any irrigation from starting automatically.

! **NOTE:** Select the **AUTO RUN** mode to resume normal operation. Programmed irrigation schedules will NOT run if the controller is left in **OFF** mode.

! **NOTE:** If you intend to stop automatic irrigation only for a few days, we suggest you use the "Delay Watering" feature described in page 10.

! **NOTE:** To re-initiate watering, press the OFF button again to return to **AUTO RUN** mode.

Manual Watering

Press the OFF button until the Manual Watering screen is displayed.

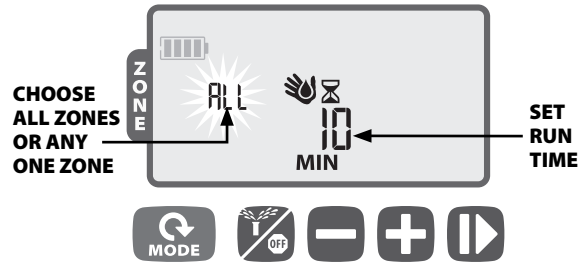

▶ Press **+** or **-** to select **ALL** Zones or **ONE** zone; then press **▶**

▶ Press **+** or **-** to set the Run Time for the selected Zones; then press **▶** to begin watering.

! **NOTE:** To water the scheduled runtime for each zone: Press **-** when setting manual runtime until the screen shows "SCH" MIN.

One-touch Manual Start

Water ALL zones immediately according to their previously scheduled run times:

▶ With the controller in **AUTO RUN** mode, press and hold **▶** for 3 seconds to begin watering all zones that have a programmed runtime.

Seasonal Adjust

Press the MODE button until the Seasonal Adjust screen is displayed.

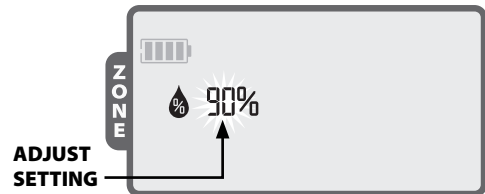

The **SEASONAL ADJUST** mode allows you to increase or decrease the run times for all zones by a certain percentage (10% to 200%).

▶ Press **+** or **-** to increase or decrease the setting.

! **NOTE:** **SEASONAL ADJUST** applies to ALL automatic watering.

Special Features

Delay Watering

Delay automatic irrigation for up to 9 days.

- ▶ Press the **MODE** button until the **AUTO RUN** screen is displayed. (Unit must NOT be watering.)



- ▶ Press and hold **+** for 3 seconds, then press **+ or -** to select the number of DAYS to delay irrigation, up to 9 days.
- ▶ To cancel, press **-** until DAYS is set to 0. (Controller will revert to **AUTO RUN**.)

SYMBOL and DAYS remaining are displayed while Rain Delay is in effect.

Contractor Default Save

Save irrigation schedules for future retrieval.

- ▶ Press the button until the **OFF** screen is displayed.
- ▶ Press and release both and **+** buttons at the same time.
- ▶ The "OFF" symbol will flash briefly to confirm schedules are saved.

Contractor Default Restore

Restore previously saved irrigation schedules.

- ▶ Press the button until the **OFF** screen is displayed.
- ▶ Press and release both **+** and buttons at the same time.
- ▶ The "OFF" symbol will flash briefly to confirm schedules are restored.

Factory Default Restore

Restore the controller's factory default settings.

CAUTION: All programmed irrigation schedules currently stored in memory will be lost. However, Contractor Default settings remain stored in separate memory and are not affected by Factory Default Restore, and can be recalled after restoring Factory Defaults.

- ▶ Press the **MODE** button until the Seasonal Adjust screen is displayed.
- ▶ Press and release both and buttons at the same time.

Rain Sensor Bypass

Set sensor to Active or Bypass for all zones.

- ▶ Press the **MODE** button until the **AUTO RUN** screen is displayed.
- ▶ Press and release both **-** and buttons at the same time to toggle between OBEY and IGNORE.

SYMBOL is displayed when IGNORE is selected.

Set sensor to Active or Bypass for any individual zone.

- ▶ Press the **MODE** button until the Set Irrigation Schedule screen is displayed.
- ▶ Press **+ or -** to select the desired zone.
- ▶ Press and release both **-** and buttons at the same time to toggle between OBEY and IGNORE.

SYMBOL is displayed when IGNORE is selected.

Installation

Valve Wiring

Wires may be extended up to 100 feet (30 meters) (18 AWG / 0.75 mm² minimum wire size) from the controller. All wire connections should be made using appropriate water-proof splice kits (not provided).

- ▶ Attach the black wires from each solenoid to the black (common) wire(s) on the WPX.
- ▶ Attach one red wire from each solenoid to the appropriate zone wire on the WPX.
- ▶ Connect an optional Master Valve.

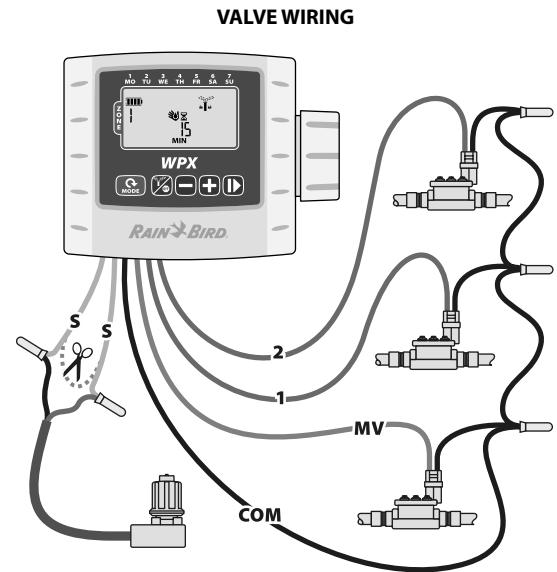

! **NOTE:** The WPX can be mounted on a DC latching solenoid using the included solenoid bracket, or on a wall using the optional wall-mount bracket (Model: 9VMOUNT).

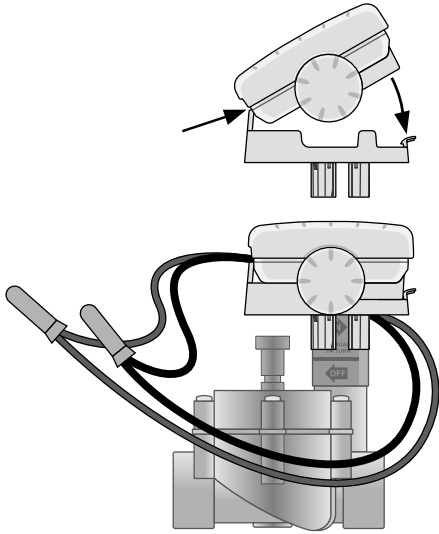

Batteries

The Rain Bird WPX uses two alkaline 9-Volt batteries to operate. Your controller will function using either one or two 9-Volt batteries. Under normal conditions, the expected life is 1 year for a single battery and two years when using two 9-Volt batteries.

Replacing Batteries

1. Remove the battery compartment cap.
2. Install one or two 9-Volt alkaline batteries on the battery clips provided.
3. Re-install the battery compartment cap.

! **NOTE:** Do not mix new batteries with old ones. Doing so could reduce the battery life and cause the controller to stop working prematurely.

Optional Rain Sensor

- ▶ Cut the yellow loop in half and remove about 1/2" of insulation.

! **NOTE:** Cut the yellow wire loop only when installing a rain sensor.

- ▶ Connect the sensor to the terminals with waterproof connectors.

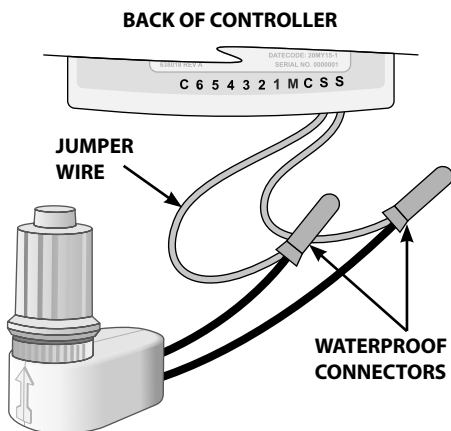

Troubleshooting

Problem	Possible Cause	Possible Solution
No Display	Display is in sleep/power save mode.	Press any key to wake up display.
	Batteries are dead.	Replace batteries.
Automatic irrigation not starting	Missing start time, run time or watering days.	Set start time, run time and watering days.
	Sensor wire loop cut but no rain sensor installed.	Re-connect the sensor wires or bypass the sensor operation.
	Rain Delay is set.	De-activate rain delay.
Automatic irrigation started but no watering occurs	No water pressure.	Turn on main water supply.
	Faulty wiring.	Check for open/short circuits in wiring.
	Faulty Solenoid.	Replace solenoid.
	Incompatible Solenoid.	Must use a 9V-latching solenoid (Rain Bird K80920) or other compatible DC latching solenoid.
Controller is watering more than expected	Excessive Start Times, Run Times or watering days.	Modify Start Times, Run Times or Watering Days as desired.
	Seasonal adjust set.	Reduce the seasonal adjust value as needed.
"Manual Watering ALL" is not watering some zones or isn't available as an option	One or more zones don't have a programmed start time or run time.	Program a start time and run time for all desired zones.



Rain Bird Corporation
6991 East Southpoint Road
Tucson, AZ 85756
EE. UU.
Tel.: (520) 741-6100
Fax: (520) 741-6522

Rain Bird International
1000 West Sierra Madre Avenue
Azusa, CA 91702
EE. UU.
Tel.: +1 (626) 963-9311
Fax: +1 (626) 852-7343

Rain Bird Europe SNC
900, rue Ampère, B.P. 72000
13792 Aix en Provence Cedex 3
FRANCIA
Tel.: (33) 4 42 24 44 61
Fax: (33) 4 42 24 24 72

Rain Bird France SNC
900, rue Ampère, B.P. 72000
13792 Aix en Provence Cedex 3
FRANCIA
Tel.: (33) 4 42 24 44 61
Fax: (33) 4 42 24 24 72

Rain Bird Ibérica. S.A.
Polígono Ind. Pinares Llanos
C/ Carpinteros, 12, 2ºC
28670 Villaviciosa de Odón, Madrid
ESPAÑA
Tel.: (34) 91 632 48 10
Fax: (34) 91 632 46 45

Rain Bird Deutschland GmbH
Königstraße 10c
70173 Stuttgart
DEUTSCHLAND
Tel.: +49 (0)711 222 54 158
Fax: +49 (0)711 222 54 200

Rain Bird Sverige AB
C/O Matrisen
Stortorget 29
211 34 Malmö
Tel.: (46) 42 25 04 80
Fax : (46) 42 20 40 65

Rain Bird Türkiye
Çamlık Mh. Diğç Sokak Sk. No.4 D:59-60
34775 Ümraniye, İstanbul
TÜRKİYE
Tel.: (90) 216 443 75 23
Faks: (90) 216 461 74 52

© 2015 Rain Bird Corporation
® Registered trademark of Rain Bird Corporation

www.rainbird.com
www.rainbird.eu

P/N: 690173-01 EN 16DE15