

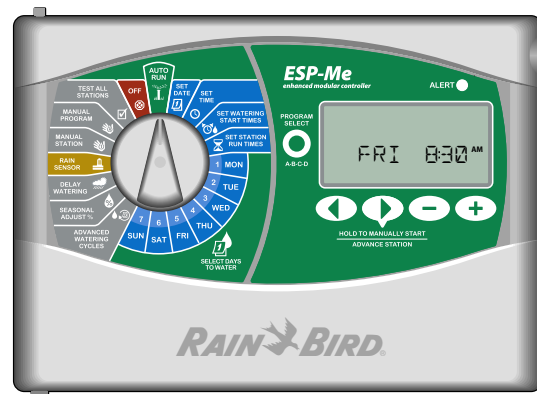







ESP-Me enhanced modular controller

User Manual





Symbols

-  **CAUTION:** Symbol is intended to alert the user to important instructions or conditions that could seriously affect irrigation effectivity or controller operation.
-  **DIAL:** Symbol indicates that the user is required to turn the dial on the controller to the appropriate position in order to follow subsequent instructions as described in that section.
-  **NOTE:** Symbol is intended to alert the user to important operating functionality, installation or maintenance instructions.
-  **REPEAT:** Symbol indicates that a repetition of previous steps or may be required in order to continue or complete the controller programming process.
-  **SPECIAL FEATURE AVAILABLE:** Symbol indicates that a Special Feature is available for the dial position. For more details see Special Features section of the Advanced User Manual.
-  **WARNING:** Symbol alerts the user to the presence of electricity or electromagnetic energy which may constitute a risk of electric shock, radiation exposure or other hazard.

Safety Information

-  **WARNING:** Date and time are retained by a lithium battery which is to be disposed of in accordance with local regulations.
-  **WARNING:** Use only Rain Bird approved accessory devices. Unapproved devices may damage controller and void warranty. For a list of compatible devices go to:
www.rainbird.com/controllersupport

 **WARNING:** You must use special precautions when valve wires (also known as station or solenoid wires) are located adjacent to or share a conduit with other wires, such as wires used for landscape lighting, other “low voltage” systems or other “high voltage” power. Be sure to separate and insulate all conductors carefully taking care not to damage wire insulation during installation. An electrical “short” (contact) between the valve wires and another source of power can damage the controller and create a fire hazard.

 **NOTE:** This appliance is not intended for use by persons (including children) with reduced physical, sensory or mental capabilities, or lack of experience and knowledge, unless they have been given supervision or instruction concerning use of the appliance by a person responsible for their safety.

Children should be supervised to ensure that they do not play with the appliance.

Disposal of Electronic Waste

 In compliance with European Directive 2002/96/CE and EURONORM EN50419:2005, this device must not be thrown away with household garbage. This device must be the object of an appropriate, selective removal procedure in order to recuperate it.

Questions?

In the USA or Canada call Rain Bird Technical Support at 1-800-724-6247 or visit our web site at www.rainbird.com/controllersupport

Questions?II
 Check Box Contents.....III
Introduction
 Welcome to Rain Bird1
 The ESP-Me Controller1
 Controller Features.....1
 Controls and Indicators.....1
 Display Legend2
Advanced Options
 Seasonal Adjust3
 Delay Watering3
 Rain Sensor3
Installation
 Installation Checklist.....4
 Gather Installation Tools.....4
 Mount Controller4
 Choose Location.....4
 Remove Knock-outs.....4
 Mount Controller.....5
 Connect Power5
 Indoor Model5
 Outdoor Model6
 Station Expansion Modules6
 Module Options.....6
 Install Modules7

Station Numbering.....7
 Module Configuration.....7
Wiring Connections8
 Connect Valves8
 Connect Master Valve8
 Connect Pump Start Relay.....9
 Connect Optional Rain Sensor
 (Wired or Wireless)..... 10
 Set Rain Sensor to Active
 (after installing a rain sensor and removing
 jumper wire on backplane) 10
Installing Optional Features
 Connect Optional Accessory 11
 Remote Programming..... 11
Troubleshooting
 Battery Life 12
 Reset Button 12
 Error Detection..... 12
 Programming Errors (blinking LED) 12
 Electrical Errors (non-blinking LED)..... 12
 Clearing Electrical Error Alerts 12
Frequently Asked Questions..... 13
Electrical Issues (solid LED illuminated) 14

Check Box Contents

- a. ESP-Me Controller (outdoor model shown)
- b. User Manual
- c. Quick Reference Guide/Programming Chart (inside controller door)
- d. Special Features Card(s) depending on model
- e. Mounting Hardware (Wire nuts for outdoor unit only)
- f. Grounded 120V Power Supply (indoor model only)
- g. Door Keys (outdoor model only)

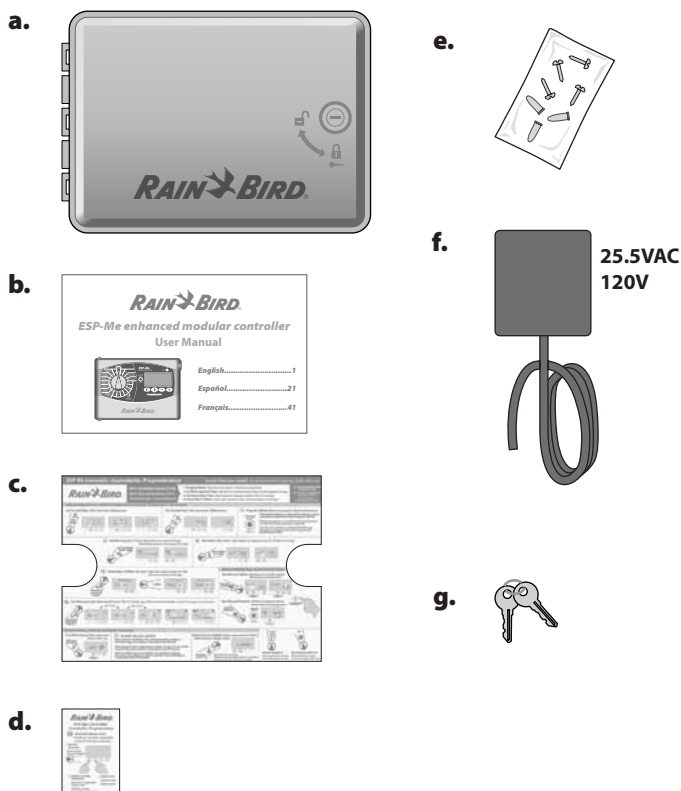

Introduction

Welcome to Rain Bird

Thank you for choosing the ESP-Me Modular Controller from Rain Bird.

For more than 70 years, the world's top irrigation contractors have chosen Rain Bird for the highest quality products and services available worldwide.

The ESP-Me Controller

Controller Features

- Expandable up to 22 stations with 3 or 6 station modules
- Supports a master valve or pump start relay and a rain sensor
- 4 available programs (A,B,C,D)
-  **NOTE:** Only one program can run at a time.
- 6 start times for each program
- Automatic alarm alerts
- 1 Touch Watering - in the Auto-Run dial position, press and hold the right arrow key

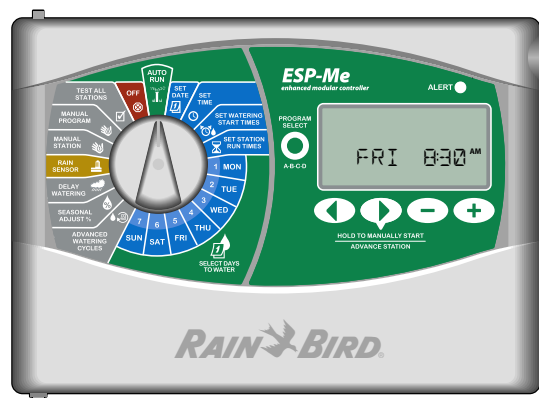

- Seasonal Adjust can be applied to a specific program or to ALL programs (Range is from 200% down to 5%)
- Delay Watering (Rain Delay) can prevent irrigation for up to 14 days
- Manual Water Station or Program allows immediate watering of an individual station or an entire program
- Test All Stations
- Total Run Time Calculator by program
- Sensor Bypass by Station

Controls and Indicators *Key operational features of the ESP-Me Controller:*

Programming Dial
Rotate the dial to select programming functions.

Water Start Times
Up to 6 per program

Set Station Run Times
1 minute to 6 hours

Program Select Button
Select Watering Program A, B, C, or D.

Alarm Indicator
Illuminates solid or flashes when an alarm condition exists.

Back/Next Buttons
Select programming options.

- / + Buttons
Adjust program settings. (Press and HOLD - or + to accelerate adjustments).

Hold to Start
Manual irrigation.

Test All Stations

Manual Watering

Rain Sensor
Applies to all programs but can be set to bypass individual stations.

Delay Watering
Up to 14 days.

Seasonal Adjust
Adjust value from 5% up to 200%













Water Day(s) Options
By Day, Odd, Even or Cyclic.

ESP-Me Controller Front Panel

Display Legend

This manual uses USA domestic icons for illustration purposes. The following table lists the differences between the domestic and international display screen symbols. Choose your voltage below to determine the LCD symbols for your controller.

Domestic vs. International Display Symbols

120V & 240V	230V	English
OFF		Off
 NEXT		Next Watering Day
MO	1	Monday
TU	2	Tuesday
WE	3	Wednesday
TH	4	Thursday
FR	5	Friday
SA	6	Saturday
SU	7	Sunday
DAY	DD	Day
MONTH	MM	Month
YEAR	YY	Year
HOUR	HH	Hour
MINUTE	MM	Minute
 1,3,5... ODD	 1,3,5,29 1, 3, 5	Odd Days
 2,4,6... EVEN	 2,4,6,30 2, 4, 6	Even Days
STATION		Station
START TIME		Start Time
RUN TIME		Run Time
REMAINING RUN TIME		Remaining Run Time
SEASONAL ADJUST %		Seasonal Adjust
DELAY		Rain Delay
MANUAL		Manual Watering
TEST		Test All Stations
DELAY	 DELAY	Delay Between Valves

Advanced Options

For Basic Setup, see the Quick Reference Guide located inside the controller door.



Seasonal Adjust

Increase or decrease watering duration based on seasonal weather conditions.



1. Turn the dial to **Seasonal Adjust %**.
2. Press **-** or **+** to increase or decrease the Seasonal Adjust percentage setting. (5 - 200%)

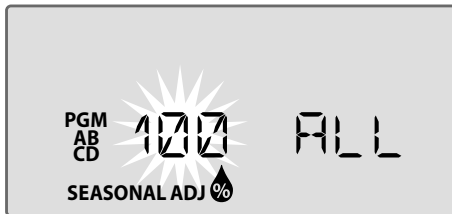

3. If adjustment will not be applied to all programs, press the **Program Select** button to select the desired program.

NOTE: Displayed run times are inclusive of any seasonal adjustment made. Example: Station 1 has a run time set for 10 minutes. The program Seasonal Adjusted value is now set to 150%. The new actual run time is 10 minutes x 150 % = 15 minutes.

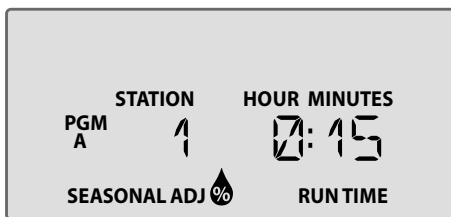

NOTE: Running a Manual Station or Program will use the Seasonal Adjusted value.



Delay Watering

Delay watering if irrigation is not needed.



1. Turn the dial to **Delay Watering**.
2. Press **-** or **+** to set the **DAYS REMAINING**. The next watering days remaining will update on the display to indicate when watering will resume.



Rain Sensor

Set the controller to obey or ignore a rain sensor. **SF** SPECIAL FEATURE AVAILABLE

The Rain Sensor setting applies to all programs and is not program specific. However, you can set any station to Bypass (Ignore) the sensor. For more details see the Special Features card or the Advanced User Manual.

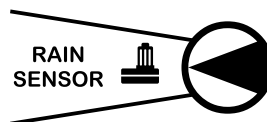

1. Turn the dial to **Rain Sensor**.
2. Press **-** or **+** to select **ACTIVE** or **BYPASS**.

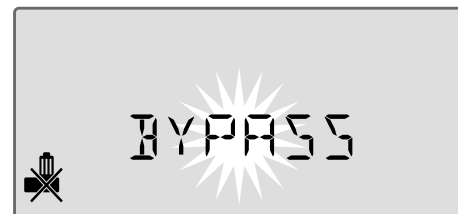

Installation

Installation Checklist

When installing the ESP-Me controller for the first time, it is recommended that you complete the following steps in order.

A check-off box is provided for each step:

- Check box contents (see page III)
- Gather installation tools (see below)
- Select a location
- Mount the controller
- Connect controller power
- Install station modules (optional)
- Connect field wires
- Complete the installation
- If a Rain Sensor is installed, turn the dial to Rain Sensor and set status to "Active" using the + key

Gather Installation Tools

Before beginning installation, gather the following tools and materials:

- a. Marking pencil
- b. Phillips screwdriver (#1, #2, #3 tip)
- c. Flathead screwdriver
- d. Hammer
- e. Level
- f. Drill and drill bit (for #8 screws)
- g. Wire Stripper
- h. Mounting Screws (included)
- i. Wall Anchors (if needed)

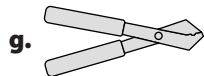
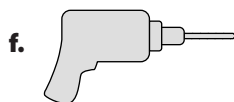
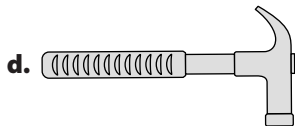

Mount Controller

Choose Location

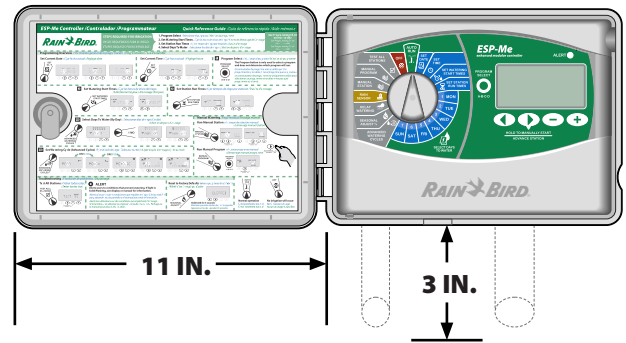

**GROUNDING
ELECTRICAL
OUTLET**

OR



**EXTERNAL
POWER
SOURCE**

**MOUNT CONTROLLER
IN PROXIMITY TO
ELECTRICAL POWER
SOURCE AS REQUIRED**

NOTE: The operating temperature range is 14°F to +149°F (-10°C to +65°C).

Remove Knock-outs

OPTIONAL

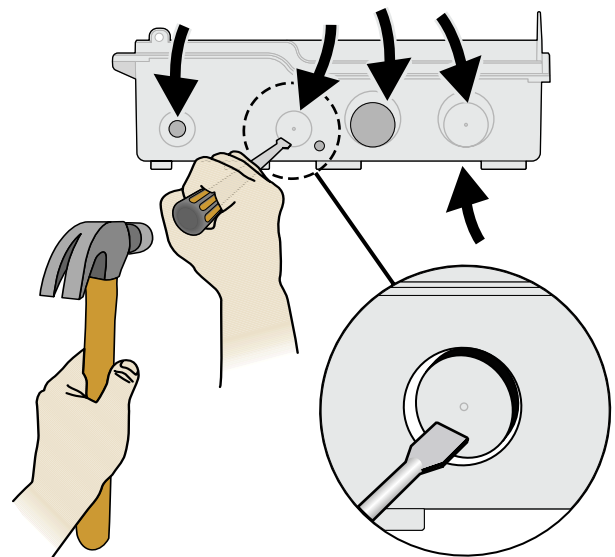

Mount Controller

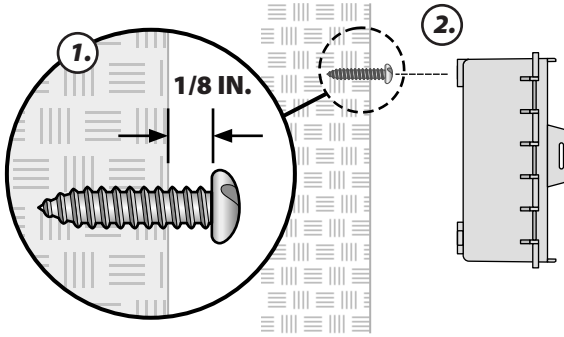

NOTE: Use wall anchors (not included) if needed.

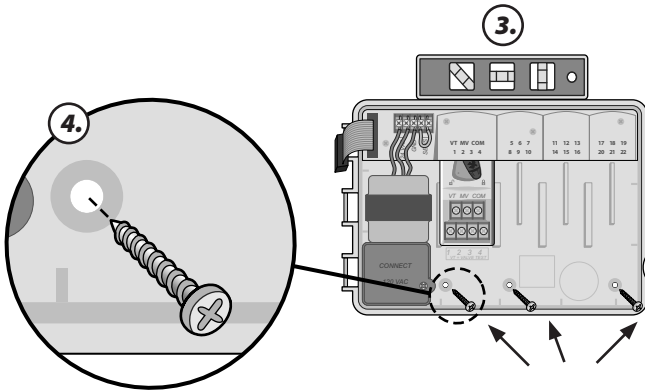

Connect Power

WARNING: DO NOT plug in the transformer or connect external power until you have completed and checked all wiring connections.

WARNING: All electrical connections and wiring runs must comply with local building codes. Some building codes require that only a licensed or certified electrician can make the power connections. Please check with your local building code for guidance. Only professional personnel shall install the controller.

Electrical Specifications (230V only)	
Input	230VAC, 0.2AMP, 50/60Hz
Output	25.5VAC, 1.0AMP, 50/60Hz

Indoor Model

1. Route the transformer power cord through the conduit opening at the bottom left of the unit. Knot the cable/cord inside the controller cabinet to prevent it from being pulled out.

CAUTION: Do not route the power cord through the field wire opening at the bottom right of the unit.

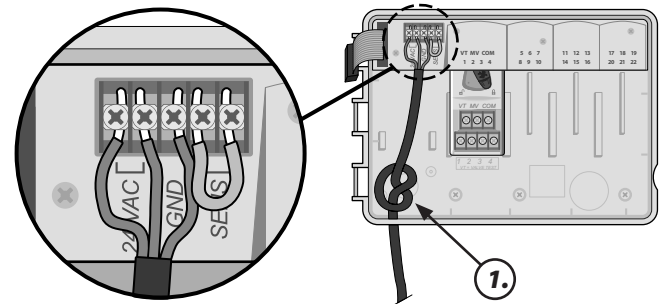

Outdoor Model

⚠ WARNING: Electric shock can cause severe injury or death. Make sure power supply is turned OFF before connecting power wires.

Power Wiring Connections	
120VAC (USA)	230VAC (International)
Black supply wire (hot) to the black transformer wire	Black supply wire (hot) to the black transformer wire
White supply wire (neutral) to the white transformer wire	Blue supply wire (neutral) to the blue transformer wire
Green supply wire (ground) to the green transformer wire	Green-with-yellow-stripe supply wire (ground) to the green-with-yellow-stripe transformer wire ($\frac{1}{2}$)

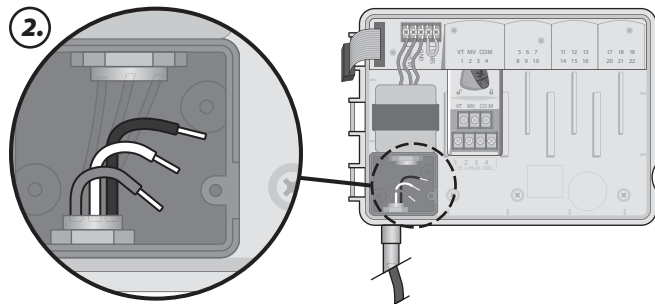
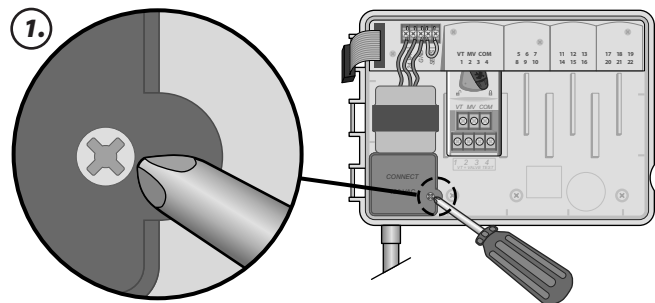

For 120V:

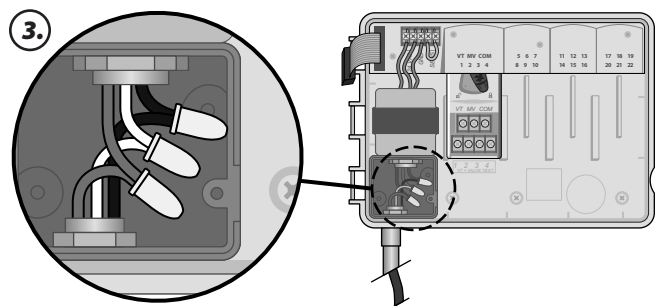

For 230V only:

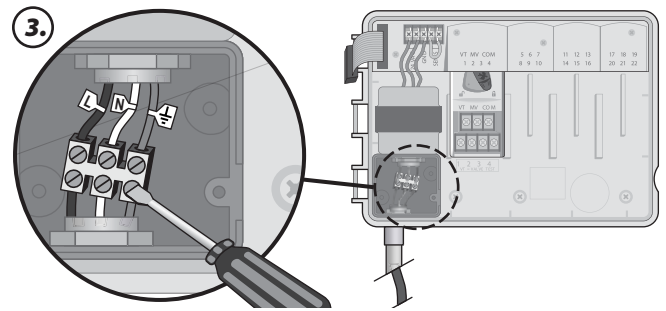

⚠ NOTE: Use either the provided wire nuts or the installed connector for this step.

⚠ WARNING: Ground wire must be connected to provide electrical surge protection. Permanently mounted conduit shall be used for connecting main voltage to the controller.

Station Expansion Modules

Additional Station Modules can increase the number of available stations up to 22.

Module Options

**Base Module
(included)**



**Expansion Modules
(sold separately)**

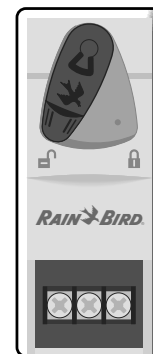

**3-STATION
(ESPSM3)**



**6-STATION
(ESPSM6)**

⚠ NOTE: 6-Station module is compatible only with the ESP-Me. They are not backwards compatible with the previous vintage controller.

⚠ NOTE: For ideal station sequencing, it is recommended that a 6-Station module always be installed in Bay 2. For more details see Station Numbering section.

Install Modules

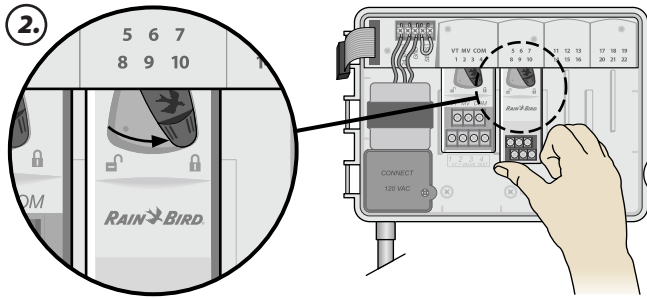
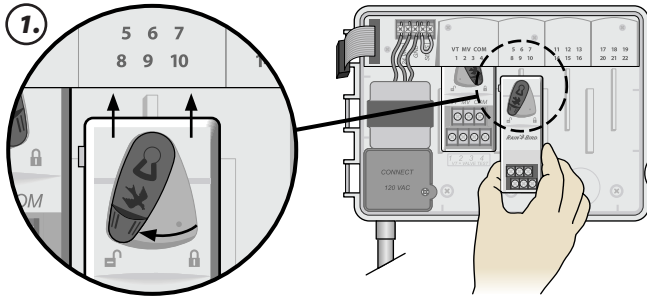

Station Numbering

Fixed Station Numbering Description

The controller is configured with Fixed Station Numbering. Each bay is set up to accept a 6 station module and reserve the station number for future use if a 6 station module is NOT installed in Bays 2, 3 or 4.

Station numbers are pre-assigned as follows:

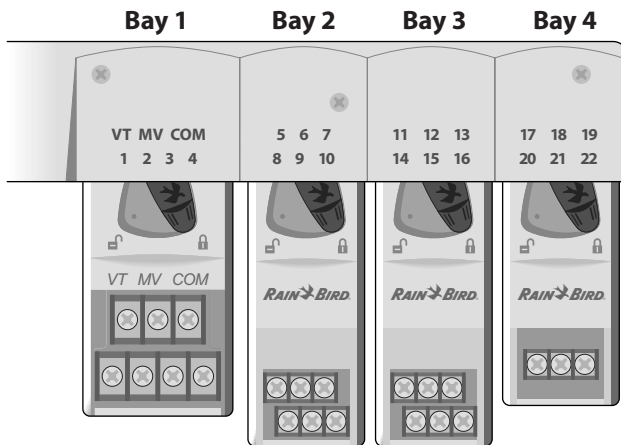

Example Of Optimum Installation Of 19 Stations

Module Configuration

Why Proper Configuration Is So Important

Example of installation with station numbering gaps:

- A total of 19 stations are installed.
- The Base Module is installed in Bay 1 and uses Stations 1 through 4.
- A 6-Station Expansion Module is installed in Bays 2 and 3.
- A 3-Station module is installed in Bay 4 and uses stations numbered 17 through 19.

Because a 3-Station module is installed in Bay 4, only the first three station numbers assigned to that bay will be used and the unused numbers will be “reserved” for future use.

During programming, the controller will skip any unused station numbers, creating a gap in station numbering.

In our example a 3-Station module was installed in Bay 4, so stations 20-22 will be unavailable for programming. During programming the missing stations will show on the display as 20NOMOD, 21NOMOD, etc.



The screen displays “20NOMOD” with the “20” flashing to indicate that Station 20 (and also 21-22) are unused and unavailable for programming.

- !** **NOTE:** Station numbering gaps will not prevent the controller from operating properly. It only affects station numbering. During programming when connected to AC power, the controller will skip any unused stations where a module is not installed.

Wiring Connections

Connect the valve wires for each station and for a (optional) Master Valve, Pump Start Relay or Rain Sensor.

Connect Valves

CAUTION: Do not route the valve wires through the same opening as the power wiring.

1. To perform a Valve Test- connect the common wire to the "COM" terminal and the power wire to the "VT" terminal. This will immediately turn the valve "ON".

WARNING: The "VT" terminal is always powered "ON".

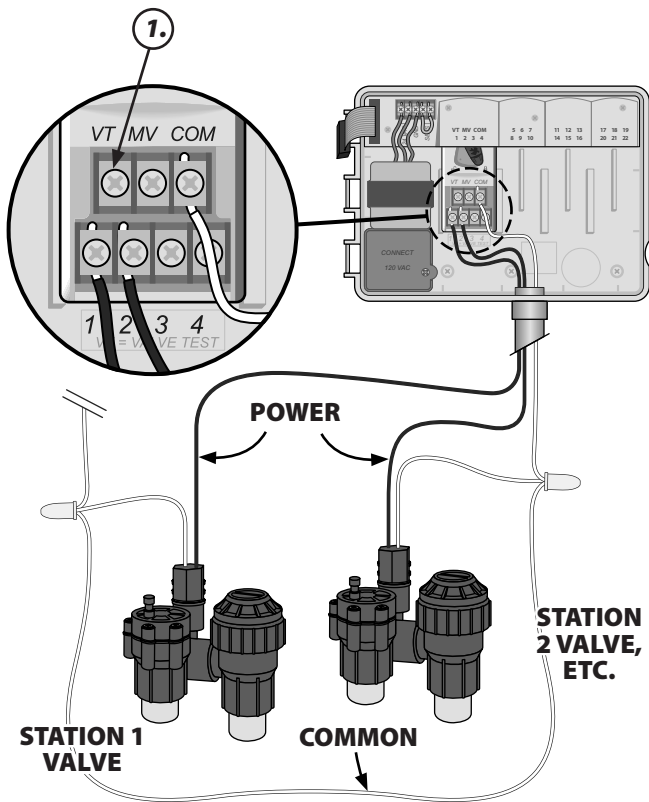

Connect Master Valve

Connect an optional Master Valve to the ESP-Me controller.

CAUTION: Do not route the master valve wires through the same opening as the power wiring.

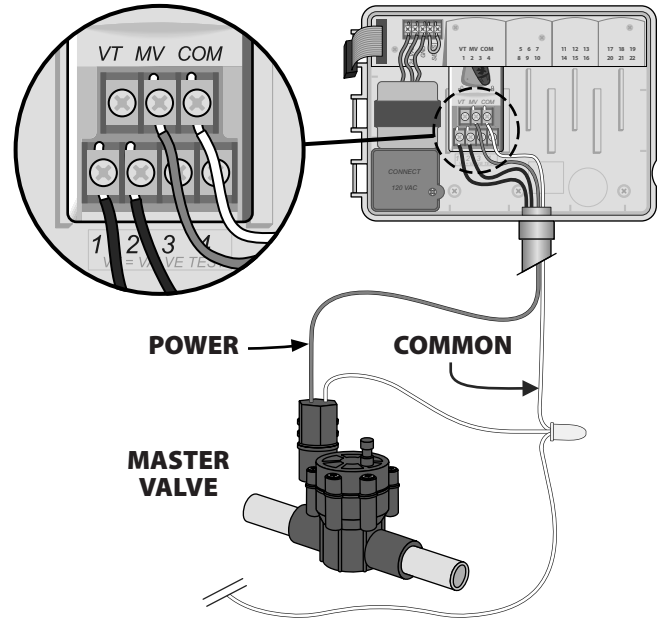

Connect Pump Start Relay

Connect an optional Pump Start Relay to the ESP-Me controller.

- NOTE:** The ESP-Me controller DOES NOT provide main power for a pump.
- CAUTION:** Do not route the pump start relay wires through the same opening as the power wiring.
- NOTE:** The controller can support a maximum Coil Inrush current of 11VA and a maximum Coil Hold current of 5VA.

The following Rain Bird Pump Start Relays are available in the USA only:

- RBSR24WG1 - Universal Pump Start Relay
- RBPL24WG1 - Pump Start Relay with Pressure Switch

For the most up to date compatibility list of pump start relays, visit our website at: www.rainbird.com/controllersupport

- NOTE:** This controller is not compatible with the Hunter® PSR22 and PSR52.

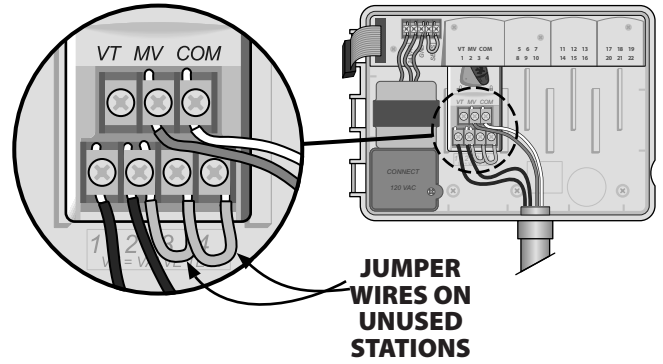
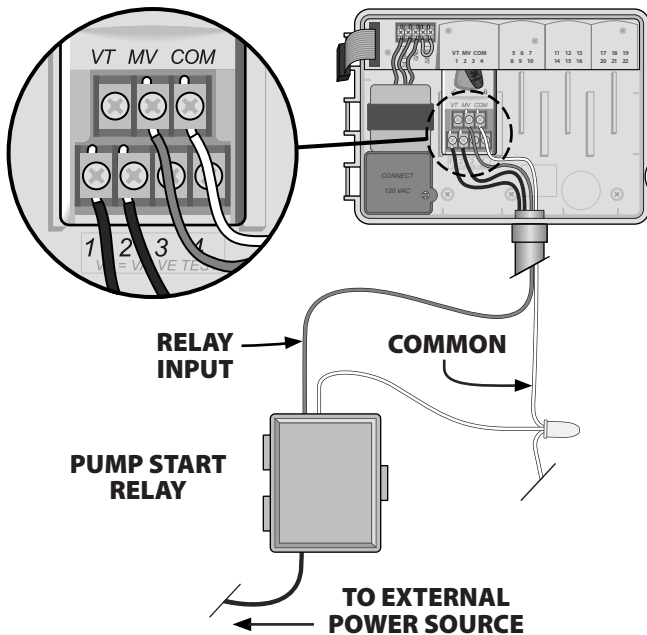

- NOTE:** Default run times for program A is 10 minutes for stations 1-4.
- CAUTION:** To avoid Dead Heading your pump do one of the following for all unused stations (module installed but not connected to a station wire):
 - Connect jumper wire across unused stations.
 - Set Station Run Time(s) to 0.
 - Set the station to Bypass the MV.

To Bypass the Master Valve for any Station:

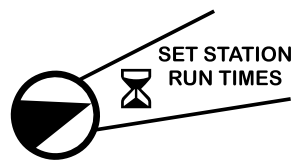

1. Turn the dial to **Set Station Run Times**.
2. Press and **HOLD** both ◀ and ▶ at the same time.
3. Press ◀ or ▶ to select the desired Station; then press - or + to set **MV ON** or **MV OFF**.

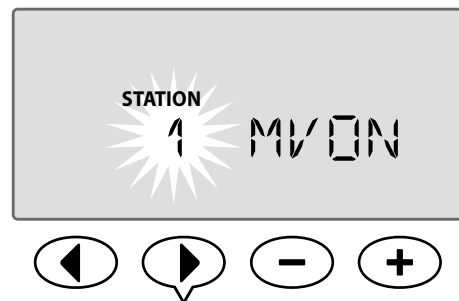

Connect Optional Rain Sensor (Wired or Wireless)

Connect an optional rain sensor to the ESP-Me controller.

NOTE: The ESP-Me Controller is not compatible with a Normally Open rain sensor. It is designed for use with a Normally Closed rain sensor.

On the terminal strip, remove the yellow jumper wire from the SENS terminals and discard.

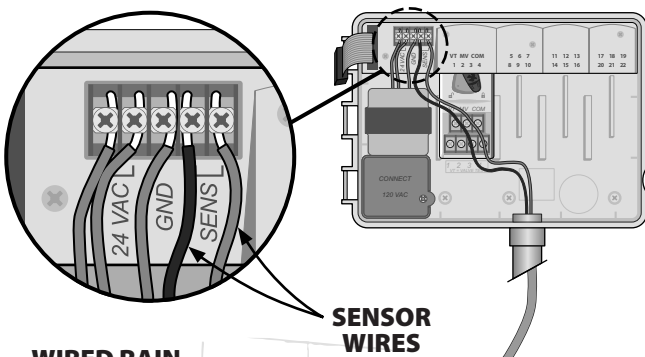
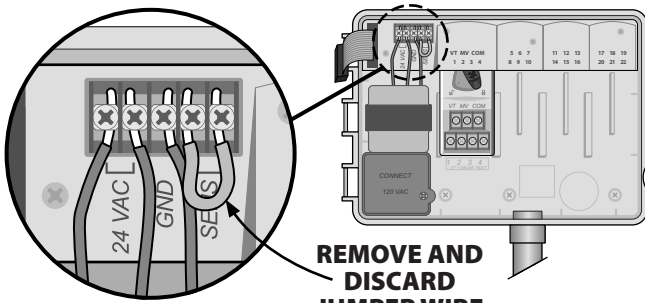

WIRED RAIN SENSOR SHOWN.

OPTIONAL WIRELESS RAIN SENSOR RAIN BIRD MODEL # WR2RC OR WR2RFC IS AVAILABLE

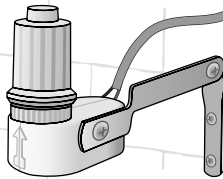

Set Rain Sensor to Active (after installing a rain sensor and removing jumper wire on backplane)

Set the controller to obey a rain sensor.

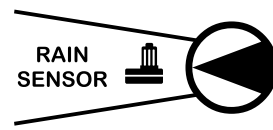

1. Turn the dial to **Rain Sensor**.
2. Press **-** or **+** to select **ACTIVE**.

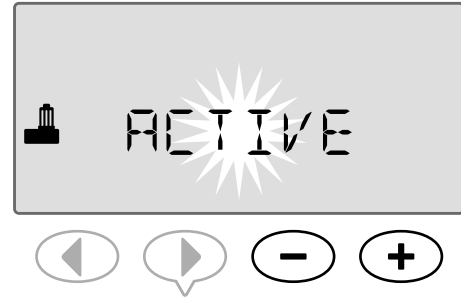

The rain sensor symbol will show on the display in **AUTO RUN** or **OFF** when Rain Sensor is set to **BYPASS**.

SYMBOL SHOWN



When Rain Sensor is set to **ACTIVE**, no symbol is shown.

NO SYMBOL

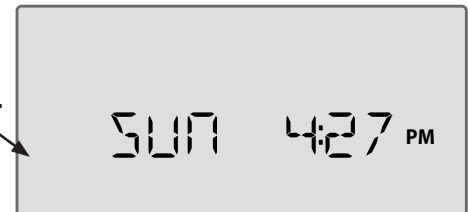

NOTE: For more details see Rain Sensor in the Advanced Options section of the Advanced User Manual.

NOTE: The Alert light no longer illuminates when irrigation is delayed due to rainfall.

Installing Optional Features

Connect Optional Accessory

! **NOTE:** Use only Rain Bird approved devices with 5 pin accessory port. Unapproved devices may damage controller and void warranty.

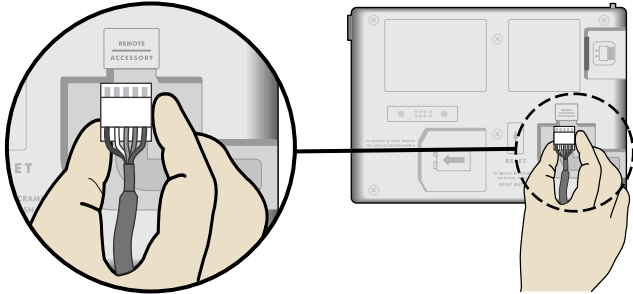

Remote Programming

Program the front panel remotely on battery power.

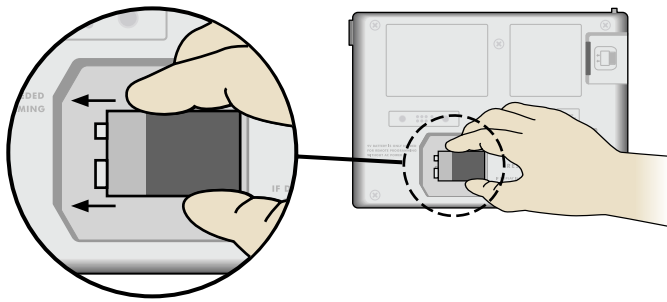

! **HOMEOWNER NOTE:** The following do not require a 9V battery to maintain:



- Date and Time are maintained up to 10 years by an internal Lithium battery.
- Programs and Settings are permanently stored in controllers non-volatile memory.

Troubleshooting

Battery Life

If the display repeatedly shows “-----” when using a 9V battery for remote programming, replace the battery.

Reset Button

Press RESET if the controller is not working properly.

The Reset button resets the controller. Active irrigation is canceled, but all previously programmed watering schedules remain stored in memory. Irrigation will resume at the next scheduled Start Time.

1. Insert a small tool into the access hole and press until the controller is reset.

NOTE: We suggest using a non-metallic object such as a pencil or pen to press the Reset button.

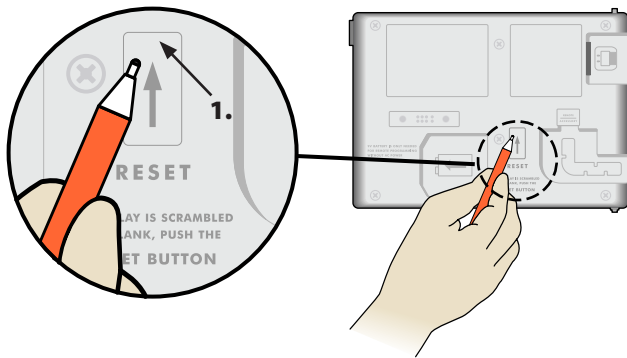

Error Detection

The ESP-Me controller has built-in error detection that can automatically generate an alert caused by an essential programming error or if an electrical short condition is detected.

The Alert LED light on the ESP-Me controller front panel will light up to indicate an alarm condition:



Programming Errors (blinking LED)

Error	Alert LED	Error Message On Display
No Start Times are set	BLINK	NO START TIMES
No Run Times are set	BLINK	NO RUN TIMES
No Watering Days are set	BLINK	NO WATER DAYS

The ESP-Me controller will reset or clear when the error is corrected.

NOTE: The dial must be in the AUTO RUN position for an Alert message to appear on the display.

Electrical Errors (non-blinking LED)

Error	Alert LED	Error Message On Display
Master Valve short	SOLID	MASTER VALVE/PUMP WIRE SHORTED OR HIGH CURRENT
Station short	SOLID	STATION “X” WIRE SHORTED

When an electrical error is detected, irrigation for the affected station is cancelled and watering advances to the next operable station in the program.

The controller will attempt to water the affected station again at the next scheduled watering. Completion of a successful watering will clear the error condition associated with that station.



Clearing Electrical Error Alerts

Turn the dial to the AUTO RUN position to view the error message on the display. To clear the Alert, press the right arrow key

Frequently Asked Questions

Problem	Possible Cause	Possible Solution
Display shows a program is active, but system isn't watering.	Water source not supplying water.	Verify there is no disruption to the main water line and that all other water supply lines are open and functioning properly.
	Wiring is loose or not properly connected.	Check that field wiring and master valve or pump start relay wiring is securely connected at the controller and in the field.
	Field wires are corroded or damaged.	Check field wiring for damage and replace if necessary. Check wiring connections and replace with watertight splice connectors if needed.
	Loss of AC power.	When there is a power loss and a 9 volt battery is installed, the system does not irrigate but programs show as remaining active.
NO AC message on display.	No Power detected.	Check circuit breaker and that unit is plugged into socket or properly connected to power source.
	Controller may be plugged into a GFI outlet or an outlet that is wired to a GFI outlet.	Check power to the outlet or reset the circuit breaker.
Programmed schedules do not start.	Connected rain sensor may be activated.	Set Rain Sensor to BYPASS to ignore the rain sensor. If watering resumes, the sensor is operating properly and no further correction is needed.
	Connected rain sensor may not be operating properly.	Let the rain sensor dry out, or disconnect it from the controller terminal strip and replace it with a jumper wire connecting the two SENS terminals, or set to Bypass.
	If no rain sensor is connected, the jumper wire connecting the two SENS terminals on the terminal strip may be missing or damaged.	Move dial position to Sensor Bypass and set to Bypass.
It just rained and the alarm light is not illuminated, why?	This is normal operation. The ESP-Me does not consider the interruption of irrigation due to rainfall an alarm condition.	This is normal operation.

Electrical Issues (solid LED illuminated)

Problem	Possible Cause	Possible Solution
Display is blank, frozen or will not accept programming.	Power not reaching the controller.	Verify the main AC power supply is securely plugged in or connected and working properly.
	Controller needs to be reset.	Press the Reset Button. For details see "Reset Button" section.
	An electrical surge may have interfered with the controller's electronics.	Unplug the controller for 2 minutes, then plug it back in. If there is no permanent damage, the controller should accept programming and resume normal operation.
Automatic error detection indicates a problem by Alert LED and an error message on display.	Short circuit or overload condition in valve, master valve or pump start relay wiring.	Identify and repair the fault in the wiring. Refer to compatible pump start relays. For details see "Connect Pump Start Relay" section.
LED is flashing or solidly illuminated but I see no message on the LCD.	Dial not in AUTO RUN position.	Turn dial to AUTO RUN position.

for more details visit www.rainbird.com/controllersupport



Declaration of Conformity

Rain Bird Corporation hereby declares that the ESP-Me irrigation controller families conform to the European Directives 2004/108/EC for "Electromagnetic Compatibility" and 2006/95/EC for "Low Voltage"

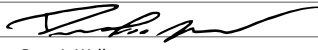
Place San Diego
Signature 
Full Name Ryan L. Walker
Position Director

Rain Bird Corporation
970 W. Sierra Madre
Azusa, California 91702
U.S.A
626-963-9311

Rain Bird Europe
900 rue-Ampere, BP 72000
13792 Aix-en-Provence
CEDEX 3 FRANCE
(33) 04 42 24 44 61

Rain Bird International, Inc.
145 North Grand Avenue
Glendora, CA 91741
U.S.A
626-963-9311

**Technical Services for U.S.
and Canada only:**
1 (800) RAINBIRD
www.rainbird.com

FCC Part 15

This equipment has been tested and found to comply with the limits for a Class B digital device, pursuant to Part 15 of the FCC Rules. These limits are designed to provide reasonable protection against harmful interference in a residential installation. This equipment generates, uses, and can radiate radio frequency energy and, if not installed and used in accordance with the instructions, may cause harmful interference to radio communications. However, there is no guarantee that interference will not occur in a particular installation. If the equipment does cause harmful interference to radio or television reception, which can be determined by turning the equipment off and on, the user is encouraged to try to correct the interference by the following measures:

- Reorient or relocate the receiving antenna.
- Increase the separation between the equipment and receiver.
- Connect the equipment into an outlet on a circuit different from that to which the receiver is connected.
- Consult the dealer or an experienced radio/TV technician for help.

Changes or modifications not expressly approved by Rain Bird Corporation could void the user's authority to operate the equipment. This product was FCC certified under test conditions that included the use of shielded I/O cables and connectors between system components. To be in compliance with FCC regulations, the user must use shielded cables and connectors and install them properly.



Rain Bird Corporation
6991 East Southpoint Road
Tucson, AZ 85756
USA
Tel: (520) 741-6100
Fax: (520) 741-6522

Rain Bird International
1000 West Sierra Madre Avenue
Azusa, CA 91702
USA
Tel: +1 (626) 963-9311
Fax: +1 (626) 852-7343

Rain Bird Europe SNC
900, rue Ampère, B.P. 72000
13792 Aix en Provence Cedex 3
FRANCE
Tel: (33) 4 42 24 44 61
Fax: (33) 4 42 24 24 72

Rain Bird France SNC
900, rue Ampère, B.P. 72000
13792 Aix en Provence Cedex 3
FRANCE
Tel: (33) 4 42 24 44 61
Fax: (33) 4 42 24 24 72

Rain Bird Ibérica. S.A.
Polígono Ind. Pinares Llanos
C/ Carpinteros, 12, 2ºC
28670 Villaviciosa de Odón, Madrid
ESPAÑA
Tel: (34) 91 632 48 10
Fax: (34) 91 632 46 45

Rain Bird Desutschland GmbH
Oberjesinger Str. 53
71083 Herrenberg-Kuppigen
DEUTSCHLAND
Tel: (49) 07032 99010
Fax: (49) 07032 9901 11

Rain Bird Sverige AB
Fleningevägen 315
254 77 Fleninge
SWEDEN
Tel: (46) 42 25 04 80
Fax : (46) 42 20 40 65

Rain Bird Turkey
İstiklal Mahallesi,
Alemdağ Caddesi, No.262
34760 Ümraniye İstanbul
TÜRKİYE
Tel: (90) 216 443 75 23
Fax: (90) 216 461 74 52

www.rainbird.com
www.rainbird.eu
1-800-724-6247