



## XF SERIES DRIPLINE

DESIGN, INSTALLATION AND MAINTENANCE GUIDE



The Intelligent Use of Water™

## INDEX | TABLE OF CONTENTS

**SECTION 1 — INTRODUCTION** ..... 3  
 About Rain Bird / The Intelligent Use of Water ..... 5  
 Leed Library ..... 6  
 Benefits of Dripline Irrigation ..... 7

**SECTION 2 — PREPARATION FOR DESIGN** ..... 8  
 XF Series Dripline | Where is it used? ..... 9  
 Preparation for Design ..... 10  
 Determine Soil Type ..... 11

**SECTION 3 — DETERMINE DRIPLINE SPECIFICATIONS** ..... 12

**SECTION 4 — DETERMINE TYPE OF DRIPLINE LAYOUT** ..... 14  
 End Feed / Center Feed ..... 15  
 Loop / Curved Edge ..... 16  
 Branching Out or Joining Row ..... 17  
 Slopes ..... 18  
 Determine Lateral Row Spacing ..... 19

**SECTION 5 — ZONE WATER CALCULATIONS** ..... 20  
 Calculating Zone Water Requirements ..... 21  
 Calculating Application Rates ..... 22  
 Calculations for Dripline Irrigation ..... 23  
 Irrigation Formulas ..... 24

**SECTION 6 — DRIPLINE MODELS FOR EVERY APPLICATION** ..... 25  
 XFS-CV Dripline for On/Subsurface Elevated Applications ..... 26  
 XFS-CV Dripline - Specifications ..... 27  
 XFCV Dripline for On-Surface Elevated Applications ..... 28  
 XFCV Dripline - Specifications ..... 29  
 XFS Dripline for Subsurface Applications ..... 30  
 XFS Dripline - Specifications ..... 31  
 XFD Dripline for On-Surface - Level Grade Applications ..... 32  
 XFD Dripline - Specifications ..... 33  
 1/4" Dripline for Potted/Small Bed Applications ..... 34

**SECTION 7 — SUBSURFACE DESIGN, INSTALLATION & OPERATION** ..... 35  
 Best Subsurface Applications ..... 36  
 Adjust for Trees / Curved Edges ..... 37  
 Design for Confined Areas ..... 38  
 Design for Large Areas ..... 39  
 Installation Methods ..... 40-41  
 Recommended Practices ..... 42

**SECTION 8 — SPECIFYING PRODUCTS IN THE ZONE** ..... 43  
 QF Dripline Header ..... 44-46  
 Control Zone Kits ..... 47  
 Control Zone Kit Selection Chart ..... 48  
 Fittings ..... 49-51  
 Spray-to-Drip Retrofit Kits ..... 52  
 Air Relief Valve / Stakes / Flush Point ..... 53  
 Drip System Operation Indicator ..... 54

**SECTION 9 — FAQ'S, GLOSSARY, AND RESOURCES** ..... 55  
 Preventative Maintenance: Flushing / Winterizing ..... 56  
 Written Specifications and CAD Detail Drawings ..... 57  
 Frequently Asked Questions ..... 58-59  
 Glossary ..... 60-61  
 Notes ..... 62-63



XF-CV Dripline



17mm XF Insert Fittings



XF Insertion Tool

Subsurface Design, Installation and Operation



Control Zone Kit

## SECTION 1: Introduction

This guide covers the basics of design, installation, and maintenance for Rain Bird's XF Series Dripline. Included are design steps, technical data, installation layouts and design details to assist in the design of the more common dripline applications.

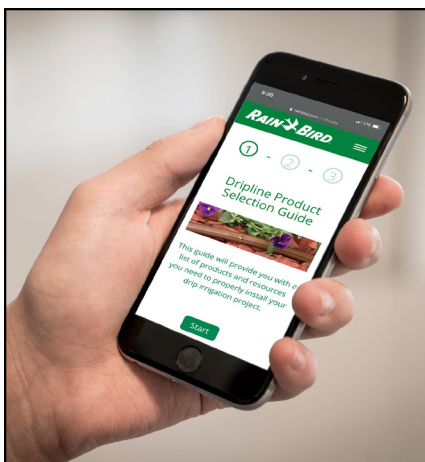

For help selecting the proper XF Series Dripline products, visit: [www.rainbird.com/calculator](http://www.rainbird.com/calculator)  
Access from your laptop, tablet or smart phone.

For more in-depth resources, visit:  
[www.rainbird.com/drip](http://www.rainbird.com/drip)

This guide covers the basics of design, installation, and maintenance for Rain Bird's XF Series Dripline. Included are design steps, technical data, installation layouts and design details to assist in the design of the more common dripline applications.

A low volume irrigation system typically applies water slowly, at low pressure, at or near the root zones of plant material. Whether referred to as Drip, Xerigation®, micro irrigation, or low volume, these systems feature emission devices that apply water in gallons per hour (GPH) or liters per hour (L/HR) as opposed to the gallons per minute (GPM) or liters per minute (L/MIN) of a conventional overhead spray irrigation system. Low-volume irrigation can greatly reduce or eliminate water waste while promoting healthier plant growth because you can:

- Match the amount of water applied to the specific need of each plant
- More closely match the application rate to the soil's infiltration rate
- Apply water directly to the root zone, reducing overspray and evaporation

Low-volume systems also reduce or eliminate runoff on walks and paved areas, and overspray onto windows, fences, pavement and walls. The Rain Bird Xerigation® line of drip products offer a full range of water-saving choices for both turf and non-turf landscape applications, including control zone components, dripline, fittings, blank tubing, emission devices and tools.

Use of dripline is a preferred method in many low-volume irrigation applications. Rain Bird's XF Series Dripline has Rain Bird designed and manufactured emitters that provide pressure compensation for precise flow control throughout the zone. XF Series Dripline is made with advanced polymers that provide kink-resistance and reduce coil memory for easier installation. With emitter flow rates of 0.4 GPH, 0.6 GPH, and 0.9 GPH (1.6 L/HR, 2.3 L/HR, and 3.4 L/HR) and emitter spacing of 12" and 18" (0.30 m and 0.45 m) the XF Series provides a full product line to meet the needs of any application.

The Rain Bird XF Series of dripline products consists of:

- XFD –for on-surface applications
- XFCV for on-surface, sloped applications
- XFS with Copper Shield™ Technology – for subsurface applications
- XFS-CV with Heavy Duty Check Valve – for on-surface, subsurface and sloped applications

For complete performance and technical specifications, please see Rain Bird's Landscape Irrigation Products Catalog or visit Rain Bird's website at [www.rainbird.com](http://www.rainbird.com). The website provides specifications and detail drawings in downloadable files.

## SECTION 1: INTRODUCTION



XFCV for on-surface, sloped applications.

## ABOUT RAIN BIRD AND THE INTELLIGENT USE OF WATER



A privately held company founded in 1933, Rain Bird Corporation is the leading manufacturer and provider of irrigation products and services. Since its beginnings, Rain Bird has offered the industry's broadest range of irrigation products for farms, golf courses, nurseries, sports arenas, commercial developments and homes in more than 130 countries around the world. With the broadest product line in the industry, architects, designers and contractors recognize Rain Bird as the industry leader in irrigation solutions.

Rain Bird is committed to The Intelligent Use of Water™. It is our legacy to design and manufacture only those products of the highest value, quality, and efficient application of water. We work for long-term, responsible partnerships with our customers and our suppliers. This is who we are, and this is how we wish to be perceived in the irrigation industry and our communities.

Please visit The Intelligent Use of Water section of our website to explore additional resources to help you design the most water-efficient projects.

<http://www.rainbird.com/landscape/resources/IUOW.htm>

### Water Source

#### Need

Preserve potable water through alternative sourcing that taps into underutilized supplies such as underground well water, grey water and rain water.

#### Rain Bird Solution

- Non-potable-water-ready:
  - Drip products
  - Valves
  - Rotors
  - Sprays

### Apply

#### Need

Distribute water to your landscape as efficiently as possible.

#### Rain Bird Solution

- Xerigation®/Landscape Drip: Direct-to-plant-root watering devices.
- Water-smart rotor and spray features:
  - Pressure Regulating Stem (PRS) technology
  - Seal-A-Matic™ (SAM) check valves
- High-efficiency Nozzles:
  - Rain Curtain™ Nozzles
  - U-Series Nozzles
  - Matched Precipitation Rate (MPR) Nozzles
  - Square Pattern Nozzles (SQ)
  - R-VAN Series Nozzles
  - HE-VAN Series Nozzles

### Design & Manage

#### Need

Receive support from a certified professional trained to design, install, operate and maintain a water-efficient system.

#### Rain Bird Solution

Rain Bird's Contractor Referral Program helps you quickly and easily find a qualified irrigation contractor in your area.

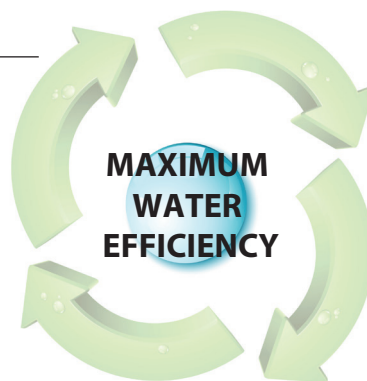

### Schedule

#### Need

Flexible programming schedules that help you customize a watering schedule based on the needs of your landscape.

#### Rain Bird Solution

Our controllers offer:

- Cycle+Soak feature allowing for the most efficient water delivery
- Easy, push-of-the-button adjustments for seasonal changes
- Weather-based controllers which adjust based on hourly weather data



**LEED LIBRARY**  
DESIGN & TECHNICAL RESOURCES

**WHAT IS LEED?**

The Leadership in Energy and Environmental Design (LEED) Green Building Rating System™ is a point rating system devised by the United States Green Building Council (USGBC) to evaluate the environmental performance of a building over its life cycle and to encourage market transformation towards sustainable design. LEED is the nationally recognized benchmark for the design, construction, and operation of high performance green buildings. LEED provides building owners and operators with the tools they need to have an immediate and measurable impact on their buildings’ performance. LEED promotes a whole-building approach to sustainability by recognizing performance in five key areas of human and environmental health: sustainable sites, water savings, energy efficiency, materials selection, and indoor environmental quality.

Detailed information on obtaining credits and the project certification process is available from the USGBC on their website: [www.usgbc.org](http://www.usgbc.org).

- **WATER EFFICIENCY CREDIT 1.1**
- **WATER EFFICIENCY LANDSCAPING: Reduce by 50% 2 points**

**Intent**

Limit or eliminate the use of potable water, or other natural surface water resources available on or near the project site, for landscape irrigation.

**Requirements**

Reduce potable water consumption for irrigation by 50% from a calculated mid-summer baseline case. Reductions shall be attributed to any combination of the following items:

- Plant species factor
- Irrigation efficiency
- Use of captured rainwater
- Use of recycled wastewater
- Use of water treated and conveyed by a public agency for non-potable uses.

**Rain Bird Notes**

The designer on the LEED project will need to provide an irrigation plan and legend, as well as calculations, a description of the baseline, and cut sheets of the irrigation system demonstrating how water consumption is reduced by 50%.

Learn more at: <http://www.rainbird.com/landscape/resources/LEEDlibrary.htm>

SECTION 1  
SECTION 2  
SECTION 3  
SECTION 4  
SECTION 5  
SECTION 6  
SECTION 7  
SECTION 8  
SECTION 9

Dripline irrigation can greatly reduce or eliminate water waste while promoting healthier plant growth for the following reasons:

- Match the water application to the specific needs of each plant
- More precisely match the application rate to the soil's infiltration rate
- Apply water directly to the root zone to reduce overspray and evaporation
- A properly designed and installed dripline irrigation system can be over 90% efficient

There are many advantages of dripline irrigation that can provide solutions for difficult-to-irrigate landscape areas including:

- Narrow turf areas
- Curved narrow landscape areas
- Sloped areas
- Subsurface turf irrigation applications
- Parking lot islands
- Steep sloped areas

Other benefits of on-surface or subsurface Drip Irrigation:

- Eliminate runoff on walks and paved areas
- Prevent overspray onto windows, walls and fences
- Increase watering uniformity
- Reduce susceptibility to vandalism
- Promote healthy plant growth

To view all dripline models online, visit:  
<http://www.rainbird.com/drip>

## BENEFITS OF DRIPLINE IRRIGATION

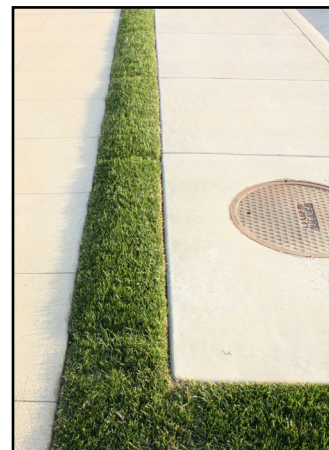

### SECTION 2: PREPARATION FOR DESIGN





**XF SERIES DRIPLINE | WHERE IS IT USED?**



Turf Grass (XFS, XFS-CV)



Curved Landscapes



Flower Beds



Small Confined Areas



Shrub & Ground Cover Beds



Narrow Landscapes



Eliminate Overspray on Buildings



Sloped Areas



Potted Plants (1/4" Dripline)

SECTION 1  
SECTION 2  
SECTION 3  
SECTION 4  
SECTION 5  
SECTION 6  
SECTION 7  
SECTION 8  
SECTION 9

### PREPERATION FOR DESIGN

Dripline system design follows many of the same rules as spray and rotor design. Similar design factors must be considered, such as point of connection, static and operating pressures, flow rates, and plant material.

A dripline system when properly designed and installed will deliver full irrigation coverage to the planted area. A dripline system is normally divided into zones. A typical zone contains a water source, a control zone (valve, filter, and pressure regulator), and the dripline with connection fittings.

**During the preparation for design you will gather essential information to design the dripline system:**

- Obtain or draw a scaled plan of the site to be irrigated
- Identify all of the slopes on the plan
- Determine the types of plants to be irrigated (groundcover, shrubs, turfgrass, and trees)
- Identify the type of soil (Clay, Loam, Sand)
- Identify the type of water from the water source (potable, non-potable, well, surface water, etc)
- Identify static and operating pressures, and volume available from the water source
- Select appropriate system components for installation

### ■ EXAMPLE OF A SUBSURFACE DRIPLINE SYSTEM LAYOUT

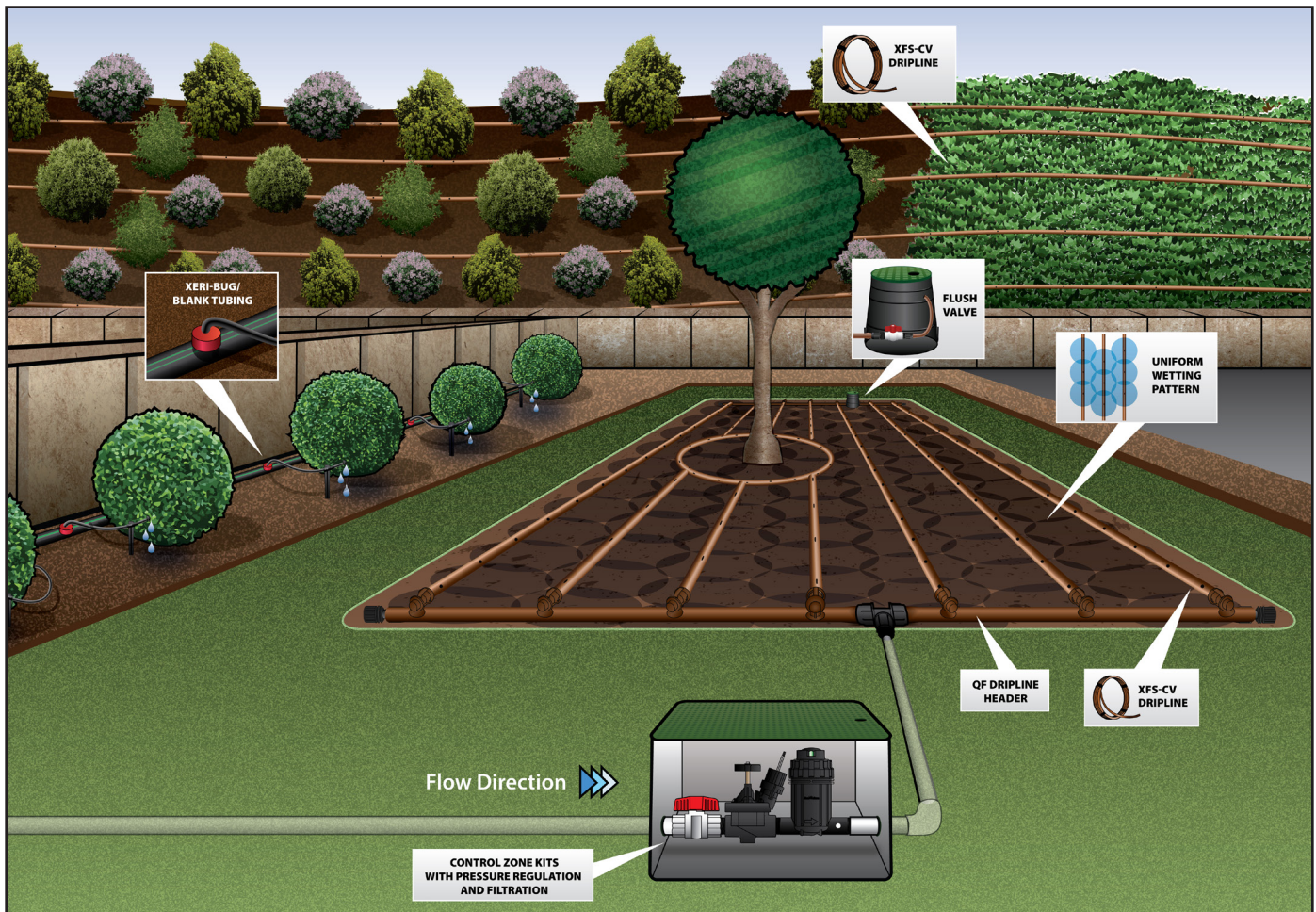

**DETERMINE SOIL TYPE | WHAT IS YOUR SOIL TYPE?**

**OVERALL DESIGN PLAN FOR THE SITE**

Soil Infiltration Rates (in Inches per Hour)			
Percent of Slope	Clay	Loam	Sand
0% - 4%	0.13 - 0.44	0.44 - 0.88	0.88 - 1.25
5% - 8%	0.1 - 0.35	0.35 - 0.7	0.7 - 1

Soil Infiltration Rates (in cm per Hour)			
Percent of Slope	Clay	Loam	Sand
0% - 4%	0.33 - 1.12	1.12 - 2.24	2.24 - 3.18
5% - 8%	0.25 - 0.89	0.89 - 1.78	1.78 - 2.54

Note: As the slope increases, infiltration rates will continue to decrease. These values are derived from USDA information.

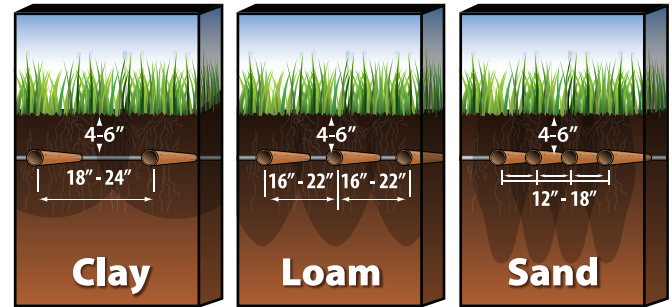

These illustrations show water movement in a subsurface application. These guidelines apply to on-surface as well as subsurface installations.

The objective of a well-designed dripline system is to create an even wetting pattern of water in the soil throughout the planting zone. There are four factors to consider for planting areas to create an even wetting pattern:

- Soil type (Clay, Loam, Sand)
- Emitter flow rate: 0.4 GPH, 0.6 GPH or 0.9 GPH (1.6 L/HR, 2.3 L/HR or 3.4 L/HR)
- Emitter spacing: 12" or 18" (0.30 m or 0.45 m)
- Lateral spacing (distance between the dripline rows)

**SOIL TYPE TEST**

1. Remove 1 to 2 cups of soil from the zone to be irrigated.
2. Place into a glass jar, like a mason jar.
3. Fill the jar half way with water. Shake and let sit for 2 hours so the particles can settle. The heavier sand particles will settle to the bottom, then silt, then clay on top.
4. Measure the combined height of all three layers of the soil then the height of each layer; divide the height of each layer by the total height to figure out the percentage of each soil in the jar.
5. Apply these figures to the "Soil Classification" chart. In the example, now you know the landscape soil is silt loam.

Measure total height and layer heights

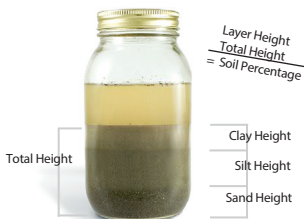

For Example:

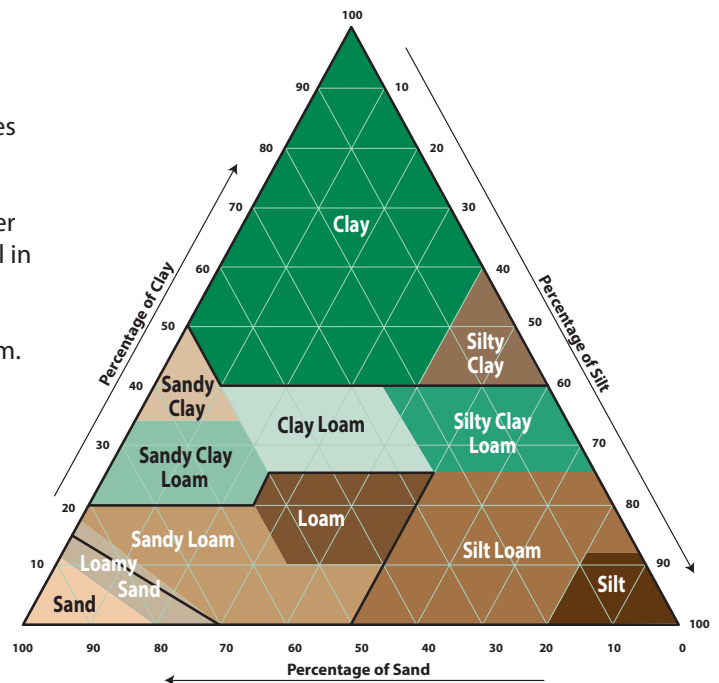
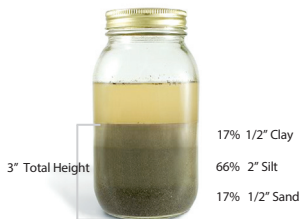

**SECTION 3:** Determine Dripline Specifications



**SECTION 3: DETERMINE DRIPLINE SPECIFICATIONS**

**■ CHOOSE THE EMITTER FLOW RATE, SPACING BETWEEN EMITTERS, AND SPACING BETWEEN ROWS**

To determine the specification for the emitter flow rate and emitter spacing for the XF Series Dripline, follow the column under the proper soil type for your application to find the emitter flow and emitter spacing.

Table 2 gives recommended emitter flow rates and spacing for three basic soil types. If the soil type is not known, or if there is a good chance that there will be many different types of soil at the site, use the shortest distance between emitters and rows from the table to be sure that the root zone is well irrigated. If there is heavy loam or clay subsoil, these soil types will reduce the downward flow of water in the soil and allow for wider lateral spacing between rows.

**■ TABLE 2: XF SERIES DRIPLINE RECOMMENDATION TABLES**

XF Series Dripline Recommendations (English)			
Soil Type	Clay	Loam	Sand
Emitter Flow Rate (gallons per hour)	0.4 GPH	0.6 GPH	0.9 GPH
Emitter Spacing (inches)	18"	18"	12"
Dripline Lateral Spacing (inches)	18" - 24"	16 - 22"	12" - 18"

XF Series Dripline Recommendations (Metric)			
Soil Type	Clay	Loam	Sand
Emitter Flow Rate (liters per hour)	1.6 L/HR	2.3 L/HR	3.4 L/HR
Emitter Spacing (meters)	0.45	0.45	0.3
Dripline Lateral Spacing (meters)	0.45 - 0.61	0.41 - 0.56	0.3 - 0.45

**Note:** These are general guidelines, field conditions may require modification to emitter flow rate, emitter spacing and lateral spacing. XF Series Dripline is to be installed at a depth of 4"-6" (10.2-15.24 cm) in subsurface and groundcover applications. Use only XFS or XFS-CV dripline in subsurface applications. XF Series Dripline may also be installed on-surface under mulch in shrub and groundcover applications.

If you are not quite sure of the soil type, here is a test you can use by squeezing the soil in your hand:

**Clay** - When dry it forms hard clumps. When damp it is flexible and can be molded into shapes.

**Loam** - A moderate sand or dirt and very little clay. When dry it breaks easily. When wet it forms a lump.

**Sand** - Soil particles are loose, sandy grains. When dry it will fall apart when you open your hand. When damp it will form a lump but it will crumble easily when touched.

### SECTION 4: Determine Type of Dripline Layout

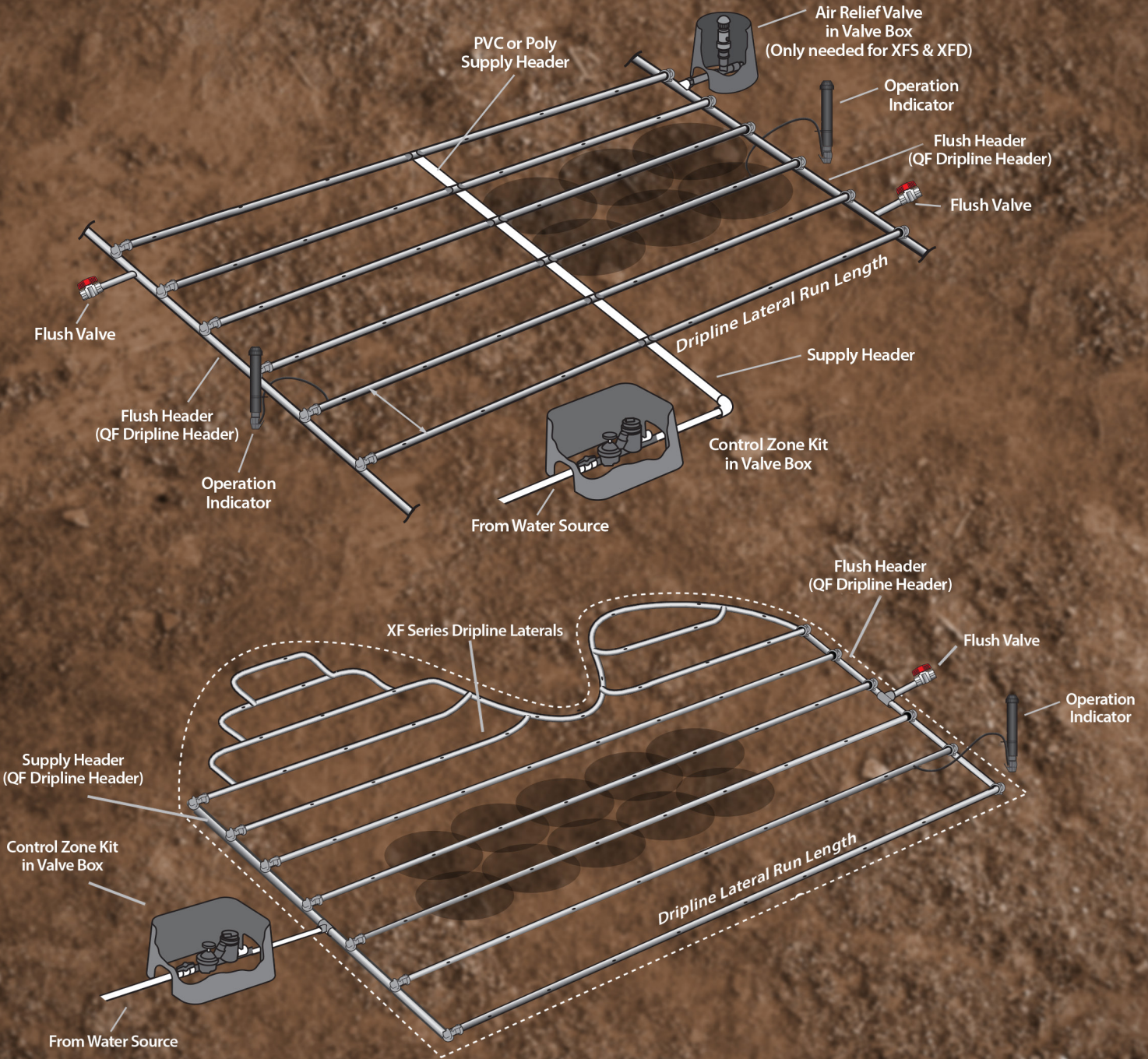

**SECTION 4: DETERMINE TYPE OF DRIPLINE LAYOUT | SUBSURFACE**

SECTION 1  
SECTION 2  
SECTION 3  
SECTION 4  
SECTION 5  
SECTION 6  
SECTION 7  
SECTION 8  
SECTION 9

**■ END FEED LAYOUT**

This Grid layout is primarily used for dense plantings. The layout uses supply headers and flush headers with rows of dripline connected at each end. The supply header and flush header form a continuous loop where all rows of dripline are being supplied from both ends.

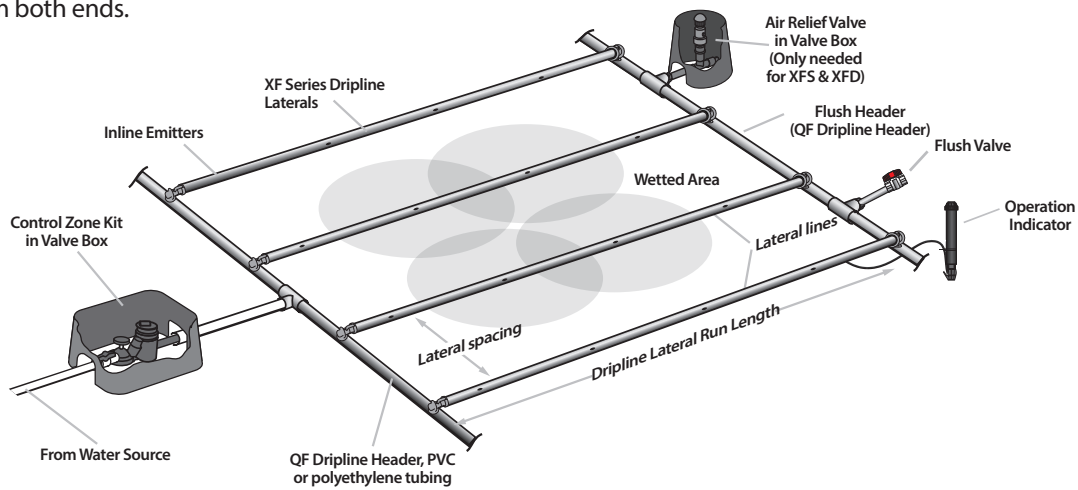

**■ CENTER FEED LAYOUT**

Where layout flexibility exists, it is recommended that Center Feed layouts be used. This allows for the most even flow of water through the zone. Center Feed layouts also potentially allow you to increase the size of the zone by providing lateral runs on both sides of the supply header. Center Feed layouts are an excellent option for median strips, road sides, and other homogenous planting zones.

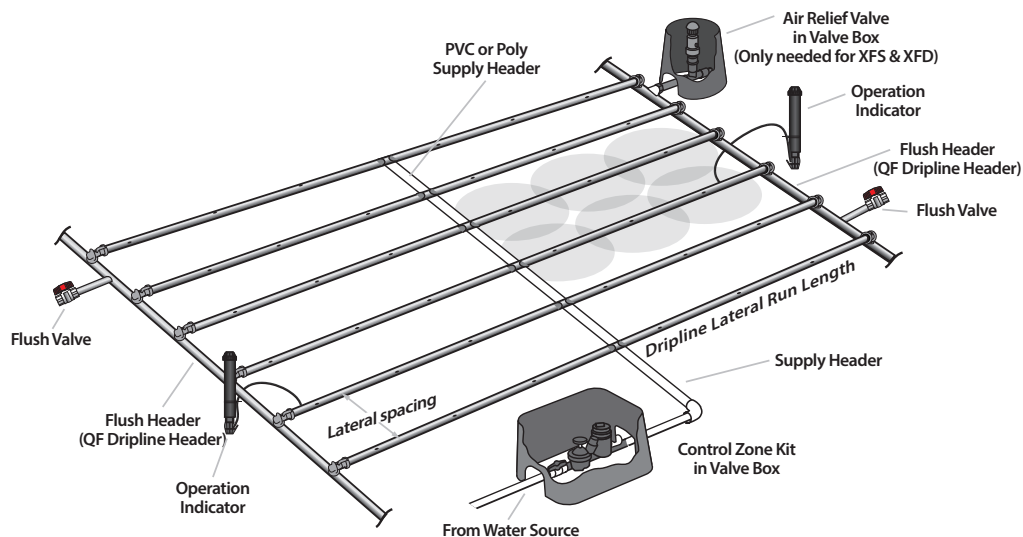

### DETERMINE TYPE OF DRIPLINE LAYOUT | ON-SURFACE

#### ■ QUICK LOOP LAYOUT

The Loop layout is one continuous loop that weaves back and forth throughout the zone in evenly spaced laterals (rows).

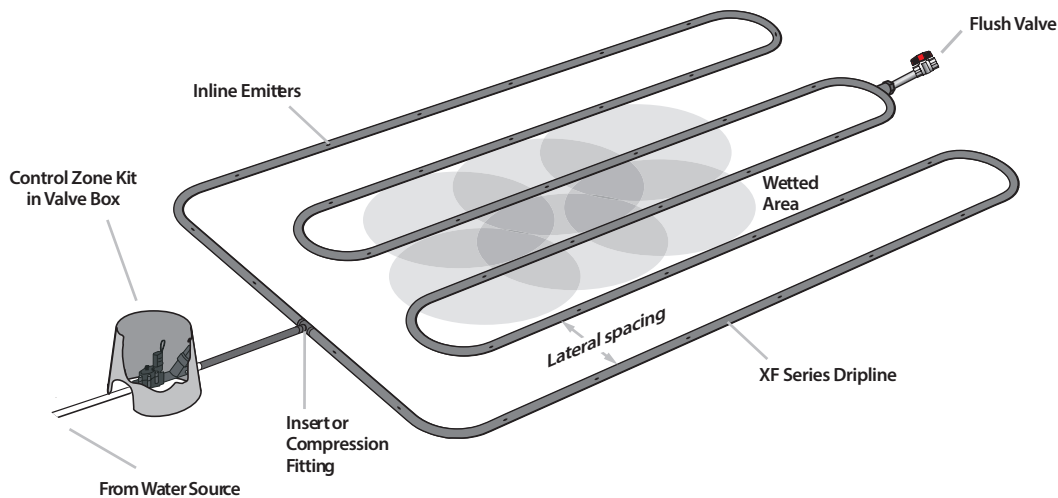

#### ■ CURVED EDGE LAYOUT

The Curved Edge layout is primarily used for dense planting areas. The layout uses supply and flush headers with rows of dripline connected at the end. The supply and flush header form a continuous loop and the dripline can be attached to the adjacent driplines with "tee" fittings to accommodate curved applications.

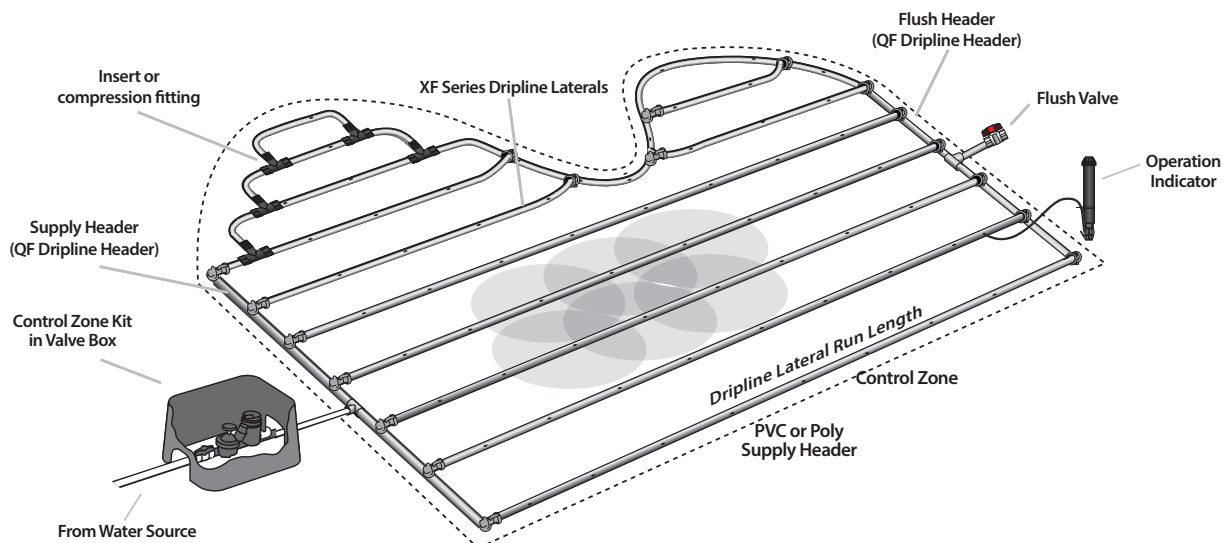



## OTHER COMMON GRID LAYOUTS

### ■ BRANCHING OUT OR JOINING LAYOUTS

When branching out from a supply header with XF Series dripline, maximum lateral run length should be considered. Add up all the “branched out” dripline and check it against the maximum lateral run lengths listed in Tables 6, 7, 8, or 9. This will vary depending on the type of tubing being used.

When joining lateral rows from a supply header, check only the longest lateral against the maximum lateral run length listed in Tables 6, 7, 8, or 9.

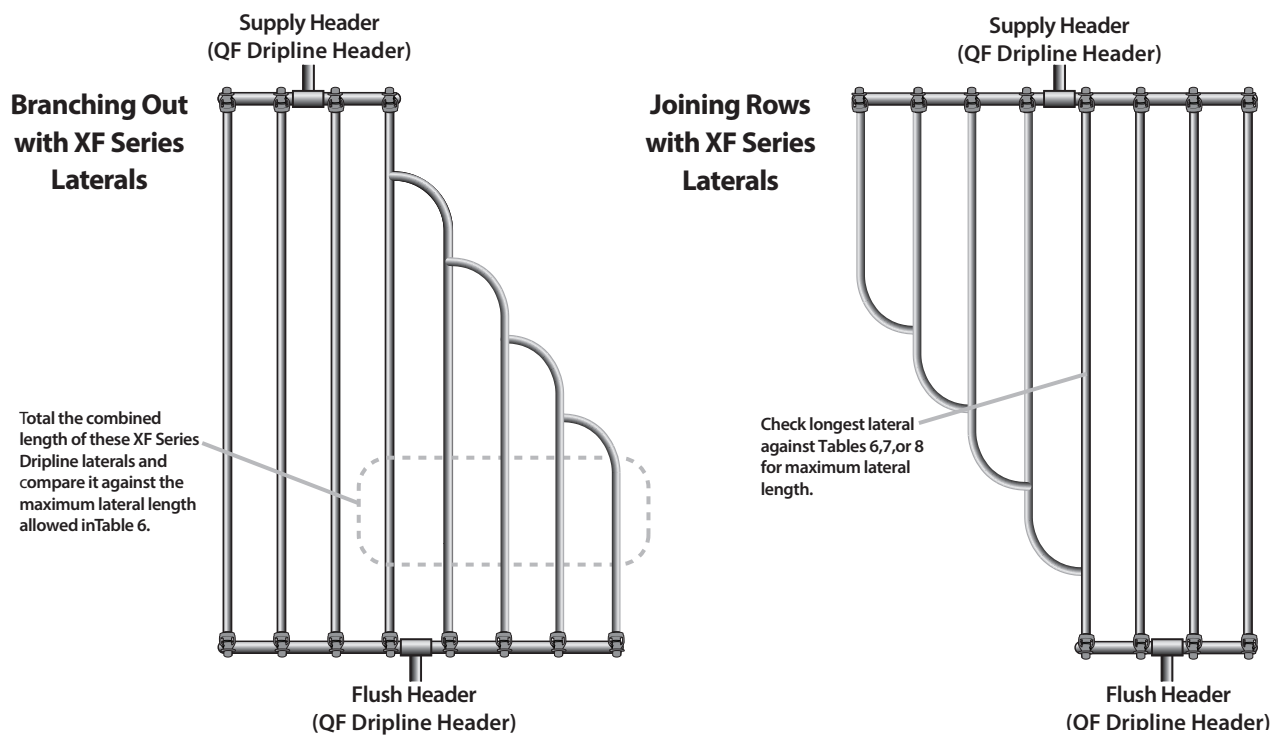

### ■ DESIGN CONSIDERATIONS

- Header should be spaced 2" - 4" (5cm-10.2 cm) from hardscape or other planting areas
- Headers may be QF Header, PVC, blank poly tubing or dripline
- Lateral spacing is a design consideration and can be calculated as shown on page 19 in “How to Calculate Equal Lateral (Row) Spacing”
- The lateral run length should not exceed the maximum lateral run length shown in Tables 6, 7, 8, or 9
- When using “Center Feed Layout” the run length should be measured from the supply header to the flush header and should not exceed the maximum run length shown
- When using “Loop Layout”, because water is split into two separate paths that meet in the middle, the total continuous loop length of dripline should not exceed twice the maximum lateral length
- In subsurface applications an air vacuum relief valve should be installed at the highest point in the system to avoid back siphoning debris into the emitter
- Flush valves should be installed at the low point in the flush header or at the mid point of the loop layout

SECTION 1  
SECTION 2  
SECTION 3  
SECTION 4  
SECTION 5  
SECTION 6  
SECTION 7  
SECTION 8  
SECTION 9



### SLOPES

- The design of the dripline system should account for slopes on the site since runoff may occur at low points
- Slopes less than 3% do not require special design considerations
- Slopes greater than 3% should increase the dripline spacing by 25% in the bottom 1/3 of the zone
- Dripline should run perpendicular (across) the slope when possible

### ELEVATION CHANGES - SLOPE LAYOUT

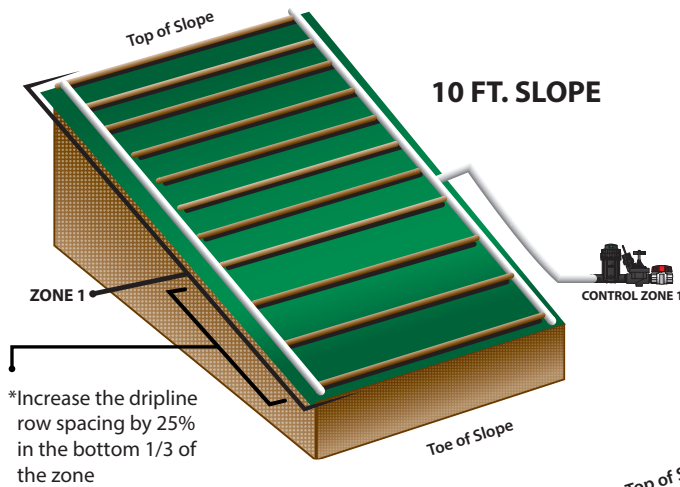

#### SLOPES UP TO 10 FT. USING XFS-CV DRIPLINE:

- With sloping landscapes up to 10 ft. of elevation change, no separate zones or check valves are required

#### SLOPES GREATER THAN 10 FT USING XFS-CV DRIPLINE:

- With steep sloping landscapes greater than 10 ft., it is recommended that additional zones are installed to reduce runoff
- The use of XFS-CV can eliminate low emitter drainage

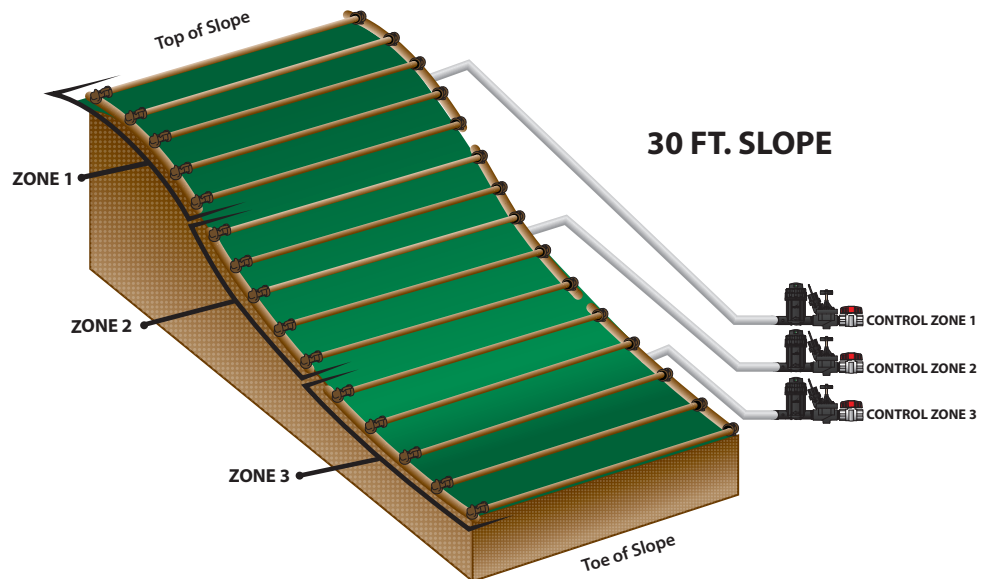

**DETERMINE LATERAL ROW SPACING**

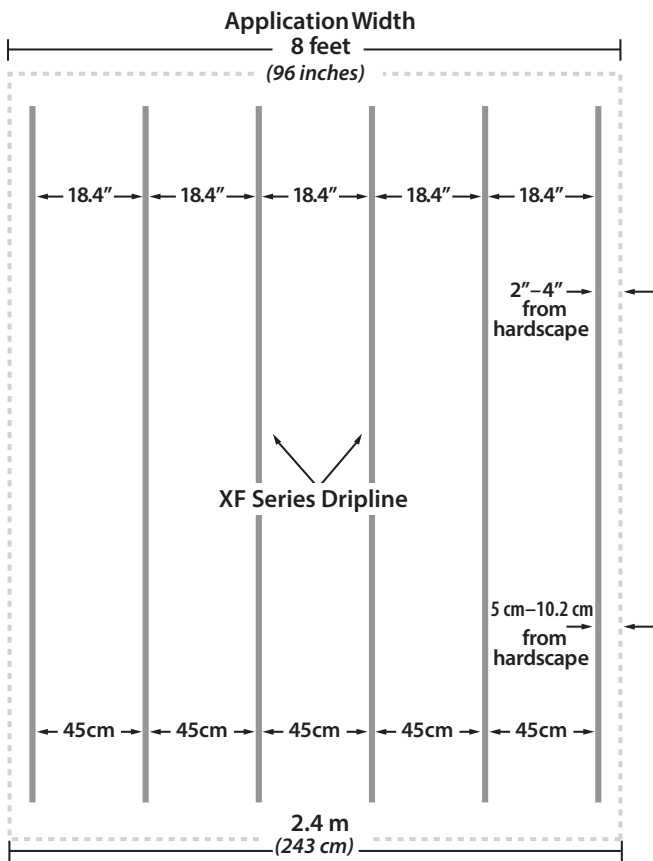

**■ HOW TO CALCULATE EQUAL LATERAL ROW SPACING WHEN MAKING CUSTOM PVC HEADERS**

Loam soil is assumed for the example below with a recommended lateral row spacing of 16"-22" as shown in Table 2 on Page 13. To calculate the specific lateral row spacing within this range, you need to know the width of the zone being irrigated and then use the calculation as show in Example 1.

**Example 1: How to Calculate Equal Lateral (Row) Spacing**

- Application width = 8' (2.4 m)
- Convert into inches: 8' x 12" = 96"  
or (Convert into centimeters: 2.43 m x 100 = 243 cm)
- It is recommended to space dripline 2" (5 cm) from hardscapes and 4" (10.2 cm) from separate planting zones

In this example there are hardscapes on each side of the planting zone. Remove the hardscape spacing on each side from the total width:

$$96'' - (2 \times 2'') = 92'' \quad (243 \text{ cm} - (2 \times 5 \text{ cm}) = 233 \text{ cm})$$

- For loam soil, the range of lateral row spacing is 16"-22" (40.6 cm - 55.9 cm). Choosing 18", calculate the number of spaces between rows:  $92'' \div 18'' = 5.1$  ( $233 \text{ cm} \div 0.45 \text{ m} = 5.1$ ). Round to get whole spaces. Round up if the decimal is 0.5 or higher, round down if it is less than 0.5. In this case you should round down to 5 whole spaces between rows.
- Calculate the equal lateral row spacing:  $92'' \div 5 = 18.4''$  ( $233 \text{ cm} \div 5 = 45 \text{ cm}$ )
- Calculate the number of dripline rows by adding 1 to the number of spaces between rows:  $5 + 1 = 6$  dripline rows

SECTION 1  
SECTION 2  
SECTION 3  
SECTION 4  
SECTION 5  
SECTION 6  
SECTION 7  
SECTION 8  
SECTION 9

**SECTION 5: Zone Water Calculations**



**TABLE 3: CALCULATING ZONE WATER REQUIREMENTS**

XF Series Dripline Flow (per 100 feet)						
Emitter Spacing	0.4 GPH Emitter		0.6 GPH Emitter		0.9 GPH Emitter	
Inches	GPH	GPM	GPH	GPM	GPH	GPM
12"	42	0.70	61	1.02	92	1.53
18"	28	0.47	41	0.68	61	1.02

XF Series Dripline Flow (per 100 Meters)						
Emitter Spacing	1.6 L/HR Emitter		2.3 L/HR Emitter		3.4 L/HR Emitter	
Centimeters	L/HR	L/MIN	L/HR	L/MIN	L/HR	L/MIN
30cm	533	8.89	767	12.78	1133	18.89
46cm	348	5.80	500	8.33	739	12.32

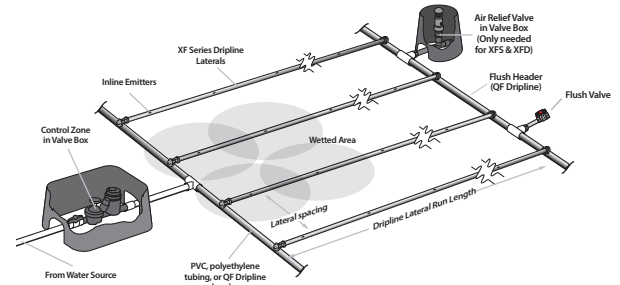

Note: This example represents approximately 650' of dripline.

After the dripline layout design is complete, you will need to identify total zone flow. This is used to help select mainline, supply and flush headers, and control zone kit (valve, filter, and regulator).

1. Calculating zone water requirements can be done by adding up the total length of dripline in the zone. Convert the total dripline length to hundreds of feet (meters). 650 feet (198 m) would be 6.5 in hundreds of feet (1.98 m).
2. Multiply total dripline length in hundreds of feet (meters) by the flow per 100 feet (meters) for your specified dripline. This can be found in Table 3. To read the table, select the emitter flow rate in the row across the top (0.4 GPH (1.6 L/HR), 0.6 GPH (2.3 L/HR), or 0.9 GPH (3.4 L/HR) and then select the emitter spacing in the left column (12" (0.30 m) or 18" (0.46 m)). Follow emitter flow rate down and emitter spacing across to find the flow per 100 feet (meters) for the XF Series dripline specified.
3. For example, for a zone that has 650 feet (198 m) of 0.9 GPH (3.4 L/HR) emitters and 18" (0.46 m) emitter spacing, the calculation would be  $6.50 \times 1.02 \text{ GPM} = 6.6 \text{ GPM}$  ( $1.98 \text{ m} \times 12.32 \text{ L/MIN} = 24.4 \text{ L/MIN}$ ) for the zone.
4. Supply lines and headers should be sized to provide the flow to the zone without exceeding 5 feet (meters) per second velocity. This can be done using the zone water requirement and referencing information on the appropriate piping located at [www.rainbird.com/reference](http://www.rainbird.com/reference) or in the back reference section in the Rain Bird catalog.

**TABLE 4: DETERMINE MAXIMUM FLOW PER ZONE**

Maximum Flow Per Zone (English)					
Sch. 40 PVC or QF Header Size	Max. Flow* GPM	psi Loss**	Poly Pipe Header Size	Max. Flow* GPM	psi Loss**
½"	4.7 GPM	7.7 psi	½"	4.7 GPM	8.8 psi
¾"	8.3 GPM	5.6 psi	¾"	8.3 GPM	6.3 psi
1"	13.5 GPM	4.2 psi	1"	13.5 GPM	4.8 psi
1-¼"	23.1 GPM	3.1 psi	1-¼"	23.1 GPM	3.1 psi
1-½"	33.9 GPM	2.9 psi	1-½"	33.9 GPM	2.9 psi
2"	52.4 GPM	1.9 psi	2"	52.4 GPM	1.9 psi

Maximum Flow Per Zone (Metric)					
Sch. 40 PVC or QF Header Size	Max. Flow* L/MIN	psi Loss**	Poly Pipe Header Size	Max. Flow* L/MIN	psi Loss**
1.27 cm	17.8	0.53	1.27 cm	17.8	0.61
1.91 cm	31.4	0.39	1.91 cm	31.4	0.43
2.54 cm	51.1	0.29	2.54 cm	51.1	0.33
3.18 cm	87.4	0.21	3.18 cm	87.4	0.22
3.81 cm	128.3	0.20	3.81 cm	128.3	0.20
5.08 cm	198.4	0.13	5.08 cm	198.4	0.13

\* Based on maximum velocity of 5' per second  
\*\* Per 100' of tubing

\* Based on maximum velocity of 1.52 m per second  
\*\* Per 30.5 meters of tubing

## CALCULATING APPLICATION RATES

### APPLICATION RATE

The application rate is the rate that XF Series Dripline applies water to the soil. This is used to determine run times for the zone based on the plant watering requirements. Table 5 is provided to make it easy to determine application rates for every model of XF Series Dripline when using common row spacing (12"-24" / 30cm-61cm). The table is divided into three sections, a 0.4 GPH (1.6 L/HR) emitter flow section, a 0.6 GPH (2.3 L/HR) emitter flow section and a 0.9 GPH (3.4 L/HR) emitter flow section. Go to the section for the specified emitter flow rate and find in the left hand column the specified emitter spacing. Next, find the lateral row spacing across the top of the table. Follow the lateral row spacing column down and the emitter spacing row across until the two meet. This is the application rate in inches per hour (centimeters per hour). For example, a 0.6 GPH (2.3 L/HR) emitter flow rate with 18" (46 cm) lateral row spacing and 18" (46 cm) emitter spacing has an application rate of 0.43 (1.09 cm/hr) inches per hour.

### TABLE 5: APPLICATION RATE

Emitter Spacing	Lateral Row Spacing (in Inches)										
	12"	13"	14"	15"	16"	17"	18"	19"	20"	22"	24"
<b>0.4 GPH Emitter Flow (Inches per hour)</b>											
12"	0.67	0.62	0.58	0.54	0.51	0.48	0.45	0.43	0.40	0.37	0.34
18"	0.45	0.41	0.39	0.36	0.34	0.32	0.30	0.28	0.27	0.25	0.22
<b>0.6 GPH Emitter Flow (Inches per hour)</b>											
12"	0.96	0.89	0.83	0.77	0.72	0.68	0.64	0.61	0.58	0.53	0.48
18"	0.64	0.59	0.55	0.51	0.48	0.45	0.43	0.41	0.39	0.35	0.32
<b>0.9 GPH Emitter Flow (Inches per hour)</b>											
12"	1.44	1.33	1.24	1.16	1.08	1.02	0.96	0.91	0.87	0.79	0.72
18"	0.96	0.89	0.83	0.77	0.72	0.68	0.64	0.61	0.58	0.53	0.48

Emitter Spacing	Lateral Row Spacing (in Centimeters)										
	30	33	36	38	41	43	46	48	51	56	61
<b>1.6 LPH Emitter Flow (cm per hour)</b>											
30cm	1.78	1.62	1.48	1.40	1.30	1.24	1.16	1.11	1.05	0.95	0.87
46cm	1.16	1.05	0.97	0.92	0.85	0.81	0.76	0.72	0.68	0.62	0.57
<b>2.3 LPH Emitter Flow (cm per hour)</b>											
30cm	2.44	2.26	2.11	1.96	1.86	1.73	1.63	1.55	1.47	1.35	1.22
46cm	1.63	1.50	1.40	1.30	1.22	1.14	1.09	1.02	0.99	0.89	0.81
<b>3.4 LPH Emitter Flow (cm per hour)</b>											
30cm	3.66	3.38	3.15	2.95	2.74	2.59	2.44	2.31	2.21	2.01	1.83
46cm	2.44	2.26	2.11	1.96	1.83	1.73	1.63	1.55	1.47	1.35	1.22

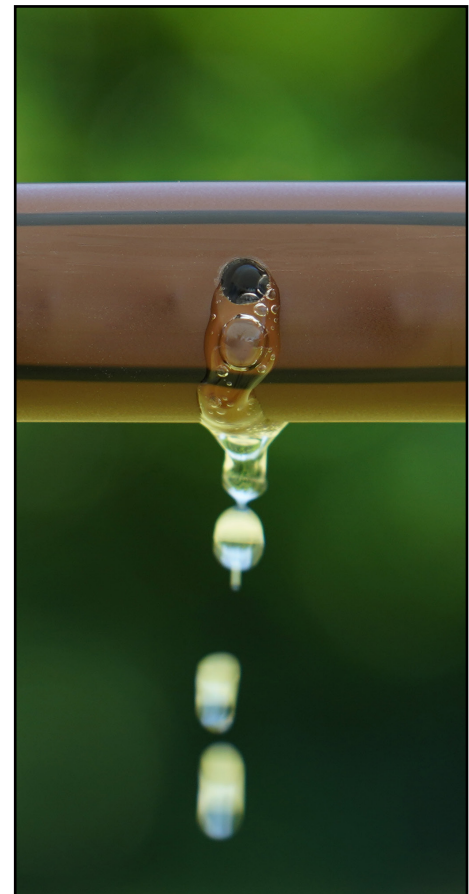

At this point the emitter flow rate and spacing between emitters and rows has been selected. Use the tables to determine the overall water application rate for the landscape area.

## CALCULATIONS FOR DRIPLINE IRRIGATION

### ■ HOW DO I DETERMINE THE APPLICATION RATE?

(METRIC)

$$\frac{\text{Emitter Flow Rate in GPH} \times 231.1}{\text{Lateral Row Spacing in Inches} \times \text{Emitter Spacing in Inches}}$$

$$\frac{\text{Emitter Flow Rate in L/HR} \times 1000}{\text{Lateral Row Spacing in cm} \times \text{Emitter Spacing in cm}}$$

**Example:**

Emitter Flow Rate	0.6 GPH
Emitter Spacing	12 inches
Lateral Row Spacing	18 inches

$$\frac{0.6 \times 231.1}{12 \times 18} = 0.64 \text{ inches/hour}$$

**Example:**

Emitter Flow Rate	2.3 L/HR
Emitter Spacing	30 cm
Lateral Row Spacing	41 cm

$$\frac{2.3 \times 1,000}{30 \times 41} = 1.86 \text{ cm/hr}$$

### ■ WHAT IS THE TOTAL FLOW WITHIN THE DRIP ZONE?

$$\frac{\text{Irrigated Area in Sq Ft.} \times \text{Emitter Flow in GPH} \times 2.4}{\text{Lateral Row Spacing in Inches} \times \text{Emitter Spacing in Inches}}$$

$$\frac{\text{Irrigated Area in Sq Meters} \times \text{Emitter Flow in L/HR} \times 166.7}{\text{Lateral Row Spacing in cm} \times \text{Emitter Spacing in cm}}$$

**Example:**

Irrigated Area	2500 Sq Ft
Emitter Flow Rate	0.6 GPH
Emitter Spacing	18 inches
Lateral Row Spacing	18 inches

$$\frac{2500 \times 0.6 \times 2.4}{18 \times 18} = 11.11 \text{ GPM}$$

**Example:**

Irrigated Area	800 Sq Meters
Emitter Flow Rate	3.4 L/HR
Emitter Spacing	46 cm
Lateral Row Spacing	48 cm

$$\frac{800 \times 3.41 \times 166.7}{46 \times 48} = 206 \text{ L/MIN}$$

### ■ HOW MUCH DRIPLINE DO I NEED BASED ON SIZE OF IRRIGATED AREA?

$$\frac{\text{Area in Sq Ft.} \times 12}{\text{Lateral Row Spacing in Inches}}$$

$$\frac{\text{Area in Sq. Meters} \times 100}{\text{Lateral Row Spacing in cm}}$$

**Example:**

Irrigated Area	2165 Sq Ft
Lateral Row Spacing	18 inches

$$\frac{2165 \times 12}{18} = 1443 \text{ feet of dripline needed}$$

**Example:**

Irrigated Area	425 Sq Meters
Lateral Row Spacing	36 cm

$$\frac{425 \times 100}{36} = 1180 \text{ meters of dripline needed}$$

### ■ HOW MANY FEET OF DRIPLINE CAN I USE IF I KNOW THE AVAILABLE FLOW

$$\frac{\text{Available Flow}}{\text{Flow per 100 Foot Length}} \times 100 = \text{Maximum Feet}$$

$$\frac{\text{Available Flow}}{\text{Flow per 100 Meter Length}} \times 100 = \text{Maximum Meters}$$

Obtain "Flow per 100 Feet"

**Example:**

You have 11 GPM available flow  
0.6 GPH emitters on 18" spacing - See table 3

$$\frac{11 \text{ GPM}}{0.68 \text{ GPM}} \times 100 \text{ feet} = 1618 \text{ maximum feet of dripline}$$

Obtain "Flow per 100 Meters"

**Example:**

You have 130 L/MIN available flow  
2.3 L/HR emitters on 0.46 meter spacing - See table 3

$$\frac{130 \text{ L/MIN}}{2.31 \text{ L/HR}} \times 100 \text{ meters} = 5628 \text{ maximum feet of dripline}$$

## IRRIGATION FORMULAS

### ■ PLANT WATER REQUIREMENT FOR A DENSE PLANTING SCHEME

The water requirement for a densely planted hydro-zone is measured in inches per day.

$$\text{Plant Water Requirement} = \text{PET} \times K_c$$

**Potential Evapotranspiration (PET)** - The amount of water that is used by the combination of evaporation from the soil and transpiration from plants growing in the soil. PET is generally expressed in inches per day.

**$K_c$**  - Adjustment factor to PET that accounts for the needs of a specific plant in growing conditions. It is also known as the "crop coefficient" or the "plant factor."

**Example:** The PET for a day in the summer for Las Vegas is: 0.30" (0.76 cm)

The  $K_c$  or "plant factor" for a certain type of plant and its surroundings is 0.84 (2.13 cm)

$$\text{Plant Water Requirement} = 0.30" \times 0.84 = 0.25"/\text{day} \quad (0.76 \text{ cm} \times 2.13 \text{ cm} = 1.62 \text{ cm per day})$$

### ■ SYSTEM RUN TIME

The formula for system run time for dense plants is based on a measurement of flow in inches per day.

$$\text{System Run Time} = (\text{PWR} / \text{Application Rate} \times \text{Application Efficiency}) \times 60$$

$$\text{Example: } (0.25" / 0.64" \times 0.90) \times 60 = 26 \text{ minutes} \quad (0.63 \text{ cm} / 1.62 \times 0.90) \times 60 = 26 \text{ minutes}$$

**Example:**

Plant Water Requirement: 0.25"/day (0.63 cm/day)

Application Rate: 0.64" (1.62 cm)

Drip Application Efficiency: 90%

$$\text{System Run Time} = (0.25/0.64 \times 0.90) \times 60 = 26 \text{ minutes} \quad (0.63 \text{ cm} / 1.62 \times 0.90) \times 60 = 26 \text{ minutes}$$

More detailed information on calculating Plant Water Requirement and System Run Time can be found in the Low-Volume Landscape Irrigation Design Manual; Chapters 4 & 5. This manual is only available for download on our website:

<https://www.rainbird.com/sites/default/files/media/documents/2018-02/LowVolumeGuide.pdf>



## SECTION 6: Dripline Models for Every Application

<b>DRIPLINE PRODUCT</b>	 <b>XFS-CV DRIPLINE</b>	 <b>XFCV DRIPLINE</b>	 <b>XFS DRIPLINE</b>	 <b>XFD DRIPLINE</b>	 <b>1/4" DRIPLINE</b>
<b>LANDSCAPE CHALLENGES</b>	<b>ON-SURFACE AND SUBSURFACE</b> Sloped and Level Grade	<b>ON-SURFACE</b> Sloped and Level Grade	<b>SUBSURFACE</b> Level Grade	<b>ON-SURFACE</b> Level Grade Installations	<b>ON-SURFACE</b> Potted/Small Bed Installations
<b>SUB SURFACE APPLICATIONS</b>	X		X		
<b>SLOPED AREAS</b>	X	X			
<b>SHRUB &amp; GROUND COVER BEDS</b>	X	X	X	X	X
<b>CONTAINER PLANTS</b>	X	X	X	X	X
<b>CURVED LANDSCAPES</b>	X	X	X	X	X
<b>NARROW LANDSCAPED AREAS</b>	X	X	X	X	X
<b>MEDIANS OR PARKING ISLANDS</b>	X	X	X	X	
<b>TURF GRASS</b>	X		X		
<b>DRIPLINE FEATURES</b>	 <b>XFS-CV DRIPLINE</b> <ul style="list-style-type: none"> <li>• Heavy-Duty 4.3 psi Check Valve provides 10 ft. of holdback</li> <li>• Copper Shield™ emitter root intrusion</li> <li>• Longer lateral runs</li> <li>• Exceptional durability</li> <li>• Available in purple and purple stripe for non-potable water</li> </ul>	 <b>XFCV DRIPLINE</b> <ul style="list-style-type: none"> <li>• 3.5 psi Check Valve provides 8 ft. of holdback</li> <li>• Longer lateral runs</li> <li>• Exceptional durability</li> </ul>	 <b>XFS DRIPLINE</b> <ul style="list-style-type: none"> <li>• Copper Shield™ emitter root intrusion</li> <li>• Exceptional durability</li> <li>• Available in purple and purple stripe for non-potable water</li> </ul>	 <b>XFD DRIPLINE</b> <ul style="list-style-type: none"> <li>• Greater flexibility</li> <li>• Longer lateral runs</li> <li>• Exceptional durability</li> <li>• Available in purple and purple stripe for non-potable water</li> </ul>	 <b>1/4" DRIPLINE</b> <ul style="list-style-type: none"> <li>• In-line non-pressure compensated emitters</li> <li>• Perfect for pots and small beds</li> <li>• Easy installation</li> </ul>

SECTION 1  
SECTION 2  
SECTION 3  
SECTION 4  
SECTION 5  
SECTION 6  
SECTION 7  
SECTION 8  
SECTION 9

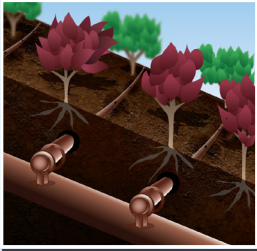

On/Sub Surface  
Sloped Applications

## XFS-CV DRIPLINE FOR ON/SUB SURFACE ELEVATED APPLICATIONS

**10 ft. of Holdback**

### ■ ELEVATED PERFORMANCE

With a patented check valve in every emitter that holds back 10' of elevation change, XFS-CV dripline eliminates low-point drainage and provides uniform irrigation throughout the zone.

### ■ COPPER SHIELD™ TECHNOLOGY



Only XFS-CV dripline includes a pure copper chip in every emitter to protect against root intrusion. Others use diluted copper compounds encapsulated in plastic.

### ■ LOW-PROFILE FLAT EMITTER



Rain Bird's low-profile flat emitter design reduces in-line pressure loss, allowing longer lateral runs, simplifying design and reducing installation time.

### ■ GREATER FLEXIBILITY



Rain Bird's proprietary blend provides industry-leading flexibility allowing for tighter turns with fewer elbows for fast and easy installation.

### ■ EASY IDENTIFICATION

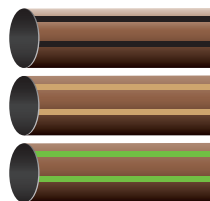

All dripline models feature color coded stripes to easily identify the flow rate:

- Black stripes** = 0.9 GPH
- Tan stripes** = 0.6 GPH
- Green stripes** = 0.4 GPH

### ■ LEED COMPLIANT



Contains at least 20% post consumer recycled polyethylene which qualifies for LEED credit 4.2.

## XFS-CV DRIPLINE - SPECIFICATIONS

### Applications

Rain Bird® XFS-CV dripline features Copper Shield™ Technology and a heavy-duty 4.3 psi check valve, making it perfect for subsurface and on-surface applications with level grades or slopes. A check valve in every emitter keeps the dripline charged in elevation changes up to 10 feet, XFS-CV can be used where no other dripline will work.

Keeping water in the dripline at all times helps for better irrigation uniformity throughout the zone. The check valve also helps prevent puddling and oversaturated soil at the low point in the zone.

### Features

#### Industry-Leading Protection

- Rain Bird's XFS-CV dripline with patented Copper Shield™ Technology protects the emitter from root intrusion. Unlike other manufacturers who use harsh chemicals or diluted copper compounds encapsulated in plastic, the Copper Shield™ Technology from Rain Bird provides root intrusion protection with a pure copper chip at each emitter
- Rain Bird's industry leading 4.3 psi emitter check valve technology keeps the dripline charged with water when elevation changes are up to 10 feet, increasing uniformity of watering and conserving water by eliminating the need to recharge the line at the beginning of each irrigation cycle

#### Easy to Use

- Through the use of a proprietary tubing material, the XFS-CV dripline is the most flexible dripline tubing in the industry, making it the easiest dripline to design with and install
- It accepts Rain Bird® XF dripline barbed insert fittings and other 17 mm barbed insert fittings
- Rain Bird's low-profile emitter design reduces in-line pressure loss, allowing longer lateral runs, simplifying design and reducing installation time
- A variety of industry standard emitter flow rates, emitter spacing and coil lengths provide design flexibility for applications with or without elevation changes

### Reliable

- The pressure-compensating emitter design provides a consistent flow over the entire lateral length, ensuring higher uniformity for increased reliability in the pressure range of 20 to 60 psi

### Durable

- Dual-layered tubing (copper over black) provides unmatched resistance to chemicals, algae growth and UV damage

### Grit Tolerant

- Rain Bird's proprietary emitter design resists clogging by use of an extra wide flow path combined with a self-flushing action

### Made with Recycled Content

- All Rain Bird XF Dripline products qualify for LEED credit 4.2 because they contain at least 20% polyethylene post-consumer recycled material by cost

### Operating Range

- **Opening Pressure:** 14.5 psi (1,0 bar)
- **Pressure:** 20 to 60 psi (1,38 to 4,14 bar)
- **Flow Rates:** 0.4, 0.6, and 0.9 GPH (1.6, 2.3, and 3.5 l/h)

- **Filtration Requirement:** 120 mesh

### Temperature:

- Water: Up to 100° F (37,8° C)
- Ambient: Up to 125° F (51,7° C)

### Specifications

- **OD:** 0.634" (16 mm)
- **ID:** 0.536" (13.61 mm)
- **Thickness:** 0.049" (1.25 mm)
- **Emitter spacing:** 12" & 18" (30,5 & 45,7 cm)
- **Coil lengths:** 100', 250', 500', and 1000' (special order) (30,5, 76,5, 152,4, and 304,9 m)
- **Coil color:** Copper, Purple and Purple Stripe  
1,000' coils available via special order

### Models

- XFSCV0412500
- XFSCV0418500
- XFSCV0612100
- XFSCV0612250
- XFSCV0612500
- XFSCV0618250
- XFSCV0618500
- XFSCV0912100
- XFSCV0912250
- XFSCV0912500
- XFSCV0918250
- XFSCV0918500
- XFSCVP412500
- XFSCVP418500
- XFSCVP612500
- XFSCVP618500
- XFSCVP912500
- XFSCVP918500
- XFSCVPS412500
- XFSCVPS418500
- XFSCVPS612500
- XFSCVPS618500
- XFSCVPS912500
- XFSCVPS918500
- XFSCV2333100

## ■ TABLE 6: LATERAL RUN LENGTHS

XFS-CV Dripline Maximum Lateral Lengths (Feet)									
psi	12" Emitter Spacing			13" Emitter Spacing			18" Emitter Spacing		
	0.4 GPH	0.6 GPH	0.9 GPH	0.4 GPH	0.6 GPH	0.9 GPH	0.4 GPH	0.6 GPH	0.9 GPH
20	104	192	136	–	192	–	120	254	215
30	366	289	205	–	289	–	545	402	337
40	461	350	248	–	350	–	645	498	416
50	524	397	281	–	397	–	748	573	477
60*	575	439	309	–	436	–	810	637	529

XFS-CV Dripline Maximum Lateral Lengths (Meters)									
Bar	30.5 cm Emitter Spacing			33 cm Emitter Spacing			45.7 cm Emitter Spacing		
	1.6 l/h	2.3 l/h	3.5 l/h	1.6 l/h	2.3 l/h	3.5 l/h	1.6 l/h	2.3 l/h	3.5 l/h
1.38	32	59	41	–	84	–	37	77	66
2.07	112	88	63	–	102	–	157	123	103
2.76	141	107	76	–	115	–	197	152	127
3.45	160	121	86	–	125	–	228	175	145
4.14*	175	133	94	–	137	–	247	194	161

\* When using 17mm insert fittings with design pressure over 50 psi (3.5 bar), it is recommended that stainless steel clamps be installed on each fitting.

SECTION 1  
SECTION 2  
SECTION 3  
SECTION 4  
SECTION 5  
SECTION 6  
SECTION 7  
SECTION 8  
SECTION 9

## XFCV DRIPLINE FOR ON-SURFACE ELEVATED APPLICATIONS

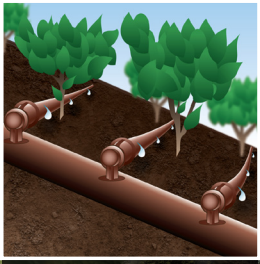

On-Surface Sloped Applications

**8 ft. of Holdback**

### Elevated Performance

Keeps dripline charged with water even with elevation changes to 8 feet. The check valve also helps to prevent over-watering at the low-point in the zone, avoiding puddling from water draining from the dripline.

### Conserves Water

Prevents puddling and water loss at the low point in the zone.

### LEED Compliant



Contains at least 20% post consumer recycled polyethylene which qualifies for LEED credit 4.2.

### Low-Profile Flat Emitter



Rain Bird's low-profile flat emitter design reduces in-line pressure loss, allowing longer lateral runs, simplifying design and reducing installation time.

### Greater Flexibility



Rain Bird's proprietary blend provides industry-leading flexibility allowing for tighter turns with fewer elbows for fast and easy installation.

### Easy Identification



All dripline models feature color coded stripes to easily identify the flow rate:

**Black stripes** = 0.9 GPH  
**Tan stripes** = 0.6 GPH

## XFCV DRIPLINE - SPECIFICATIONS

### Applications

Rain Bird® XFCV Dripline with a heavy-duty 3.5 psi check valve for on-surface applications is a valuable addition to the Rain Bird XF Series dripline family. Rain Bird's patent-pending emitter check valve keeps the dripline charged in elevation changes to 8 feet.

Keeping water in the dripline at all times improves irrigation uniformity for plants throughout the zone. The check valve also helps to prevent over-watering at the low-point in the zone, avoiding puddling from water draining from the dripline.

### Features

#### Simple

- Rain Bird's patent-pending 3.5 psi check valve technology keeps the dripline charged with water at all times, increasing uniformity of watering, and conserves water by eliminating the need to recharge the zone at the beginning of each watering cycle
- Through the use of a proprietary tubing material, the XFCV Dripline with heavy-duty check valve is the most flexible dripline tubing in the industry, making it the easiest dripline to design with and install
- It accepts Rain Bird Easy Fit Compression Fittings, XF Dripline Barbed Insert Fittings and other 17 mm barbed insert fittings
- Rain Bird's low-profile emitter design reduces in-line pressure loss, allowing longer lateral runs, simplifying design and reducing installation time
- Variety of emitter flow rates, emitter spacing and coil lengths provide design flexibility for on-surface areas with or without elevation changes

#### Made with Recycled Content

- All Rain Bird XF Dripline (XFD, XFS, XFCV, and XFS-CV) qualify for LEED credit 4.2 because they contain at least 20% post consumer recycled polyethylene. These come in an assortment of coil sizes, flow rates and emitter spacing

### Reliable

- The pressure-compensating emitter design provides a consistent flow over the entire lateral length ensuring higher uniformity for increased reliability in the pressure range of 20 to 60 psi

### Durable

- Dual-layered tubing (brown over black) provides unmatched resistance to chemicals, algae growth and UV damage

### Grit Tolerant

- Rain Bird's proprietary emitter design resists clogging by use of an extra wide flow path combined with a self-flushing action

### Operating Range

- **Opening Pressure:** 14.5 psi (1,0 bar)
- **Operating Pressure:** 20 to 60 psi (1,38 to 4,14 bar)
- **Flow rates:** 0.6 and 0.9 GPH (2,3 and 3,5 L/HR)
- **Temperature:**  
**Water:** Up to 100° F (37,8° C)  
**Ambient:** Up to 125° F (51,7° C)

### Specifications

- **OD:** 0.634" (16 mm)
- **ID:** 0.536" (13.61 mm)
- **Thickness:** 0.049" (1.25 mm)
- **Emitter spacing:** 12" & 18" (30,5 & 45,7 cm)
- **Coil lengths:** 100', 250, and 500' (30,5, 76,2, and 152,4 m)
- **Coil color:** Brown

### Models

- XFCV0612100
- XFCV0612250
- XFCV0612500
- XFCV0618100
- XFCV0618250
- XFCV0618500
- XFCV0912100
- XFCV0912250
- XFCV0912500
- XFCV0918100
- XFCV0918250
- XFCV0918500

**■ TABLE 7: LATERAL RUN LENGTHS**

XFCV Dripline Maximum Lateral Lengths (Feet)				
	12" Emitter Spacing		18" Emitter Spacing	
psi	0.6 GPH	0.9 GPH	0.6 GPH	0.9 GPH
20	192	136	254	215
30	289	205	402	337
40	350	248	498	416
50	397	281	573	477
60*	436	309	637	529

\* When using 17 mm insert fittings with design pressure over 50psi, it is recommended that stainless steel clamps be installed on each fitting.

XFCV Dripline Maximum Lateral Lengths (Meters)				
	30.5 cm Emitter Spacing		45.7 cm Emitter Spacing	
Bar	1.6 L/HR	2.3 L/HR	1.6 L/HR	2.3 L/HR
1.4	59	41	77	66
2.1	88	63	123	103
2.8	107	76	152	127
3.5	121	86	175	145
4.1*	133	94	194	161

\* When using 17 mm insert fittings with design pressure over 3.5 bar, it is recommended that stainless steel clamps be installed on each fitting.

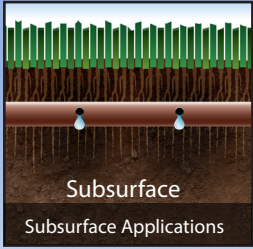

## XFS DRIPLINE FOR SUBSURFACE APPLICATIONS

Rain Bird's XFS Subsurface Dripline with Copper Shield™ Technology is the first subsurface dripline to effectively protect the emitter from root intrusion without the use of Trifluralin. Copper Shield™ Technology is the environmentally-responsible alternative to chemical inhibitors.

XFS can be used on turf grass or shrub and groundcover areas. It's also perfect for small, narrow and tight planting areas, as well as areas with tight curves or many switchbacks. It accepts Rain Bird Easy Fit Compression Fittings, XF Dripline Barbed Insert Fittings and other 17 mm barbed insert fittings.

### ■ WATER EFFICIENT

Expands use of subsurface irrigation which can be 90% efficient, resulting in up to 70% water savings.

### ■ RELIABLE

Grit tolerant emitter resists clogging by use of an extra-wide flow path combined with a self-flushing action.

### ■ INNOVATIVE

Ground-breaking solution to root intrusion with patent-pending Copper Shield™ Technology.

### ■ ENVIRONMENTALLY RESPONSIBLE

Environmentally responsible solution to root intrusion without the use of harsh chemicals.



XFS Subsurface Dripline, winner of the "Best New Product" for 2010 by the Irrigation Association



...LOOK FOR...  
SHINY METALLIC COPPER-COLORED TUBING

## XFS DRIPLINE - SPECIFICATIONS

### Applications

Rain Bird® XFS Dripline includes the patent-pending Copper Shield™ technology only available from Rain Bird. The Copper Shield™ Technology protects the emitter from root intrusion, creating a long-lasting, low maintenance subsurface drip irrigation system for use under turf grass or shrub and groundcover areas. XFS Series Dripline with Copper Shield™ is perfect for small, narrow and tight planting areas, as well as areas with tight curves or many switchbacks.

### Features

#### Simple

- Rain Bird's patent pending copper-colored XFS dripline with Copper Shield™ Technology protects the emitter from root intrusion with out requiring EPA-approved handling procedures - unlike some manufacturers who use harsh chemicals or treated filters to protect the emitter from root intrusion
- Through the use of a proprietary tubing material, the copper-colored XFS Dripline with Copper Shield™ is the most flexible dripline tubing in the industry making it the easiest subsurface dripline to design with and install
- Accepts Rain Bird XF Dripline Insert Fittings and Easy Fit Compression Fittings
- Rain Bird's low-profile emitter design reduces in-line pressure loss, allowing longer lateral runs, simplifying design and reducing installation time
- Variety of emitter flow rates, emitter spacing and coil lengths provide design flexibility for either subsurface turf grass or subsurface shrub and groundcover applications

### Reliable

- XFS emitters are protected from root intrusion by Rain Bird's patent-pending Copper Shield™ Technology resulting in a system that does not require maintenance or replacement of chemicals to prevent root intrusion
- The pressure-compensating emitter design provides a consistent flow over the entire lateral length ensuring higher uniformity for increased reliability in the pressure range of 8.5 to 60 psi

### Durable

- Dual-layered tubing (copper over black) provides unmatched resistance to chemicals, algae growth and UV damage
- Grit Tolerant: Rain Bird's proprietary emitter design resists clogging by use of an extra-wide flow path combined with a self-flushing action

### Operating Range

- **Pressure:** 8.5 to 60 psi (,58 to 4,14 bar)
- **Flow rates:** 0.42, 0.6, and 0.9 GPH (1,6, 2,3, and 3,5 L/HR)
- **Temperature:**  
**Water:** Up to 100° F (37,8° C)  
**Ambient:** Up to 125° F (51,7° C)
- **Required Filtration:** 120 Mesh

### Specifications

- **OD:** 0.634" (16 mm)
- **ID:** 0.536" (13.61 mm)
- **Thickness:** 0.049" (1.25mm)
- **Emitter Spacing:** 12", 18", 24" (30,5, 45,7, and 61,0 cm)
- **Coil lengths:** 100' and 500' (30,5 and 152,4 m)
- **Coil Color:** Copper, purple, purple stripe

### Models

- XFS-04-12-100
- XFS-04-12-500
- XFS-04-18-100
- XFS-04-18-500
- XFS-06-12-100
- XFS-06-12-500
- XFS-06-18-100
- XFS-06-18-500
- XFS-09-12-100
- XFS-09-12-500
- XFS-09-18-100
- XFS-09-18-500

#### Non Potable Purple (XFSP) or Purple Stripe (XFSPS)

- XFSP-04-12-500
- XFSP-04-18-500
- XFSP-06-12-500
- XFSP-06-18-500
- XFSP-09-12-500
- XFSP-09-18-500
- XFSPS-04-12-500
- XFSPS-04-18-500
- XFSPS-06-12-500
- XFSPS-06-18-500
- XFSPS-09-12-500
- XFSPS-09-18-500

All dripline models feature color coded stripes to easily identify the flow rate:

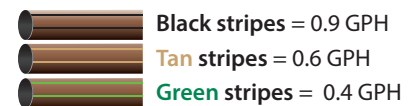

## ■ TABLE 8: LATERAL RUN LENGTHS

XFS Dripline Maximum Lateral Lengths (Feet)						
psi	12" Emitter Spacing			18" Emitter Spacing		
	0.4 GPH	0.5 GPH	0.9 GPH	0.4 GPH	0.5 GPH	0.9 GPH
15	352	273	155	374	314	250
20	399	318	169	417	353	294
30	447	360	230	481	413	350
40	488	395	235	530	465	402
50	505	417	285	610	528	420
60*	573	460	290	734	596	455

\* When using 17 mm insert fittings with design pressure over 50psi, it is recommended that stainless steel clamps be installed on each fitting.

XFS Dripline Maximum Lateral Lengths (Meters)						
Bar	30.5 cm Emitter Spacing			45.7 cm Emitter Spacing		
	1.6 L/HR	2.3 L/HR	3.4 L/HR	1.6 L/HR	2.3 L/HR	3.4 L/HR
1.03	107.2	83.2	47.2	114	95.7	76.2
1.38	121.6	96.9	51.5	127.1	107.6	89.6
2.07	136.2	109.7	70.1	146.6	125.9	106.7
2.76	148.7	120.4	77.7	161.5	141.7	122.5
3.45	153.9	127.1	86.9	185.9	160.9	128.0
4.14*	174.6	140.2	88.4	223.7	181.7	138.7

\* When using 17 mm insert fittings with design pressure over 3.5 bar, it is recommended that stainless steel clamps be installed on each fitting.

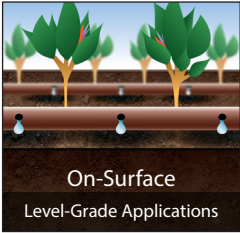

## XFD DRIPLINE FOR ON-SURFACE LEVEL-GRADE APPLICATIONS

### ■ RAIN BIRD FLAT EMITTER TECHNOLOGY Superior Design for Superior Reliability

State-of-the-art assembly technology helps resist bending and collapsing under extreme field use

Chemical-resistant silicone diaphragm for longer life

Self-flushing emitter design clears grit and debris to provide a reliable supply of clean water to plant roots

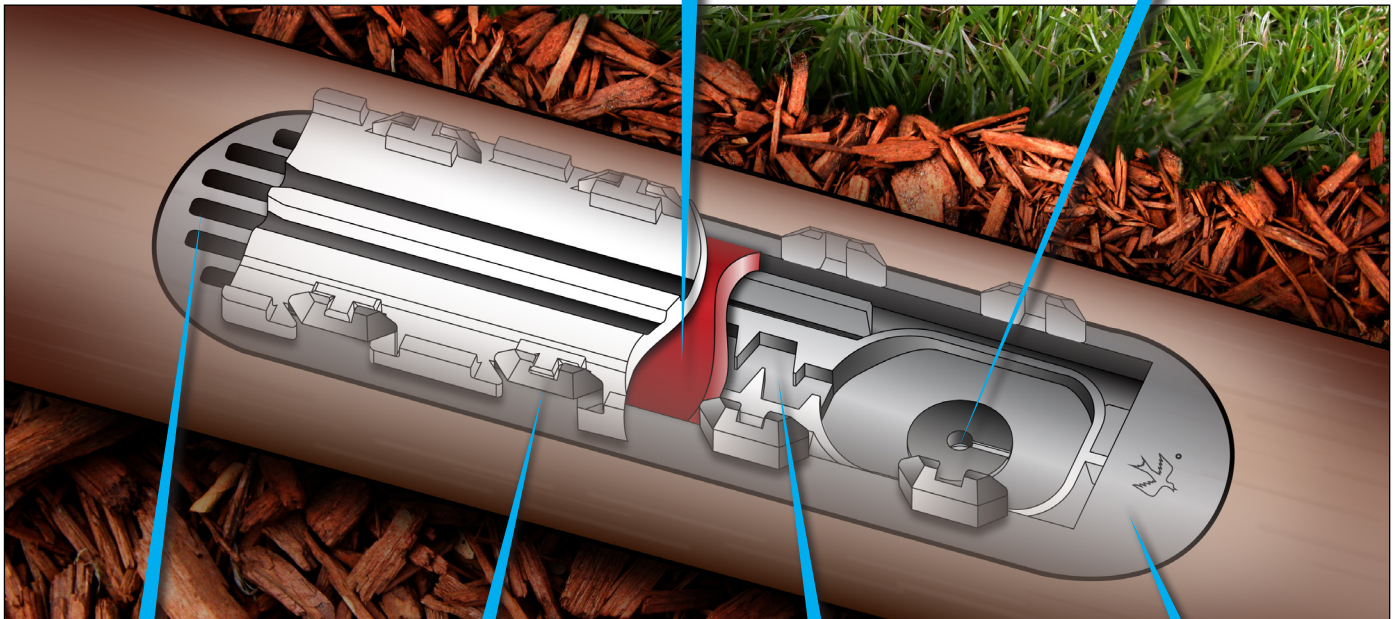

Larger inlet holes let debris pass instead of plugging emitter filter

Reinforcing members make emitter structurally more robust

Widest emitter flow channel in the industry let debris pass instead of internally plugging emitter

Low-profile design draws cleanest available water and reduces friction loss

### ■ ADDITIONAL FEATURES



XFD Dripline Coil

- Unique, extra-flexible tubing material allows for tighter turns with fewer elbows for fast and easy installation
- Dual-layered tubing (brown over black or purple over black) provides unmatched resistance to chemicals, UV damage and algae growth
- Low-profile emitter design results in reduced friction loss, allowing longer maximum lateral runs and more cost-effective system designs
- Continuous flushing action and wide flow path ensure that water will keep flowing, thus minimizing maintenance, and saving you time and money



## XFD DRIPLINE - SPECIFICATIONS

### Applications

Rain Bird® XFD Dripline is the most flexible, kink-resistant tubing available in the marketplace today, making it ideal for irrigating areas where traditional drip tubing is difficult to install. XFD Dripline is perfect for small, narrow and tight planting areas, as well as areas with tight curves or many switchbacks. XFD Dripline is simple, reliable and durable.

### Features

#### Simple

- Unique material offers significantly greater flexibility and kink-resistance for fast, easy installation
- Greater flexibility assures design capability for tight curves and spaces
- Rain Bird's self-dispensing coils make it easy to use exactly what is needed while keeping the balance of the coil ready for the next job
- Accepts Rain Bird XF Dripline Insert Fittings and Easy Fit Compression Fittings
- Variety of flow rates, spacings, and coil lengths provides design flexibility for many non-turfgrass applications

#### Reliable

- Pressure-compensating emitter design provides consistent flow over the entire lateral length, ensuring higher uniformity for increased reliability in the pressure range of 8.5 to 60 psi

#### Durable

- Dual-layered tubing (brown over black or purple over black) provides unmatched resistance to chemicals, algae growth and UV damage

### Operating Range

- **Pressure:** 8.5 to 60 psi (.58 to 4.14 bar)
- **Flow rates:** 0.6, and 0.9 GPH (2.3 and 3.41 L/HR)
- **Temperature:**
  - Water:** Up to 100° F (37.8° C)
  - Ambient:** Up to 125° F (51.7° C)
- **Required filtration:** 120 mesh

### Specifications

- **OD:** 0.634" (16 mm)
- **ID:** 0.536" (13.61 mm)
- **Thickness:** 0.049" (1.25 mm)
- **Emitter spacing:** 12" or 18" (30.5 or 45.7 cm)
- **Coil lengths:** 100', 250', and 500' (30.5, 76.5, and 152.4 m)
- **Coil color:** Brown, purple or purple stripe

### Models

#### 0.6 GPH Emitters

- XFD-06-12-100
- XFD-06-12-250
- XFD-06-12-500
- XFD-06-18-100
- XFD-06-18-250
- XFD-06-18-500

#### 0.9 GPH Emitters

- XFD-09-12-100
- XFD-09-12-250
- XFD-09-12-500
- XFD-09-18-100
- XFD-09-18-250
- XFD-09-18-500

#### Non Potable Purple (XFSP) or Purple Stripe (XFSPS)

- XFDP-06-12-500
- XFDP-06-18-500
- XFDP-09-12-500
- XFDP-09-18-500
- XFDPS-06-12-500
- XFDPS-06-18-500
- XFDPS-06-12-500
- XFDPS-09-18-500

All dripline models feature color coded stripes to easily identify the flow rate:

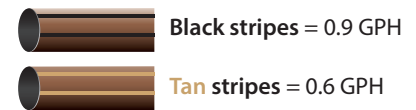

## TABLE 9: LATERAL RUN LENGTHS

XFD Dripline Maximum Lateral Lengths (Feet)				
	12" Emitter Spacing		18" Emitter Spacing	
	0.6 GPH	0.9 GPH	0.6 GPH	0.9 GPH
psi				
15	273	155	314	250
20	318	169	353	294
30	360	230	413	350
40	395	255	465	402
50	417	285	528	420
60*	460	290	596	455

XFD Dripline Maximum Lateral Lengths (Meters)				
	30.5 cm Emitter Spacing		45.7 cm Emitter Spacing	
	2.3 L/HR	3.4 L/HR	2.3 L/HR	3.4 L/HR
Bar				
1.03	83.2	47.2	95.7	76.2
1.38	96.9	51.5	107.6	89.6
2.07	109.7	70.1	125.9	106.7
2.76	120.4	77.7	141.7	122.5
3.45	127.1	86.9	160.9	128.0
4.14*	140.2	88.4	181.7	138.7

\* When using 17mm insert fittings with design pressure over 50 psi (3.5 bar), it is recommended that stainless steel clamps be installed on each fitting.



### 1/4" LANDSCAPE DRIPLINE FOR POTTED/SMALL BED APPLICATIONS

Rain Bird non-pressure compensating 1/4" Dripline is a perfect choice for small-sized areas such as planter boxes, container gardens, loops around trees, vegetable gardens and shrubs.

#### Features

- Simple to use, as the flexible tubing makes watering pots and container gardens easy
- 1/4" tubing size complements the aesthetics of any garden
- Emitters are clog-resistant through built-in filtration and two outlet holes, 180 degrees apart
- Brown "colored" tubing aesthetically matches XFD and XFCV Dripline
- Unobtrusive size and flexibility provide a low-profile, aesthetically pleasing means to irrigate plants
- Works with Rain Bird 1/4" barbed Fittings
- Available with 6" (15.25 cm) or 12" (30.5 cm) spacing, and a coil length of 100' (30.5 m) for design flexibility

#### Operating Range

- 10 to 40 psi (0.7 to 2.7 bar)
- Flow rate at 30 psi (2.0 bar): 0.8 GPH (3.0 L/HR)
- Required filtration: 200 mesh (75 microns)

#### Specifications

- **OD:** 0.250" (6 mm)
- **ID:** 0.170" (4 mm)
- **Wall thickness:** 0.040" (1 mm)
- **Emitter spacing:** 6" or 12" (15.25 and 30.5 cm)
- **Coil length:** 100' (30.5 m)
- **Coil color:** Brown

#### Models

- LDQ-08-06-100
- LDQ-08-12-100



Flow Characteristics						
Model	Flow at 30 psi		Spacing		Coil Length	
	GPH	(L/HR)	(in.)	(cm)	(ft.)	(m)
LDQ-08-06-100	0.8	3.0	6	15.25	100	30.50
LDQ-08-12-100	0.8	3.0	12	30.5	100	30.5

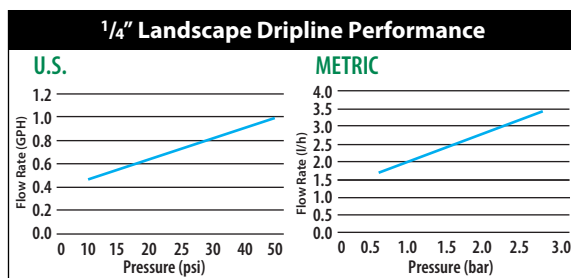

#### TABLE 10: LATERAL RUN LENGTHS

Maximum Length of Run (Feet)		
Emitter Spacing	Maximum Length of Run	Flow per Ft. @ 15psi
6"	19 feet	1 GPH/ft
12"	33 feet	0.5 GPH/ft

**SECTION 7: Subsurface Design, Installation and Operation**



#### ■ BEST SUBSURFACE APPLICATIONS

- Curves and edges
- Narrow turf areas
- Large turf areas
- Subsurface shrub and ground cover areas
- Near buildings
- Adjacent to parking lots
- Small, confined areas
- Athletic Fields

#### ■ BENEFITS OF SUBSURFACE DRIP IRRIGATION

- Increased efficiency
- Lower water use
- Elimination of overspray
- Resistant to vandalism
- Healthy plant growth
- Increased watering uniformity
- No damage to fences or trees
- Less water run-off into sewers & drains
- Lower maintenance
- Increased time for field or turf usage
- No wind issues
- Less evaporative loss

#### ■ AREAS WHERE OVERSPRAY MUST BE AVOIDED

It is a challenge to avoid overspray in narrow turf areas. Examples include median strips, parking lot islands and turf around parked cars. Also consider adding adjacent to right-of-ways. Subsurface drip is an excellent option to avoid overspray in these challenging applications.



*Narrow strips or next to roadways*



*Adjacent to buildings or hardscapes*



*Car dealerships or parking lots*

SECTION 1  
SECTION 2  
SECTION 3  
SECTION 4  
SECTION 5  
SECTION 6  
SECTION 7  
SECTION 8  
SECTION 9

## ■ ADJUST FOR TREES

**Trees.** Trees planted in turf areas should be on a separate zone. This is particularly true with subsurface drip because over time, tree roots could push the buried subsurface drip lines up to the surface. Also, trees are more costly to replace than grass, so if the zone for the grass area needs to be turned off to reduce water consumption, then a separate zone can still be operated to maintain tree health.

The best method for establishing, transplanting, and irrigating trees on a separate zone is by using the Rain Bird Root Watering System. More information can be found at <http://www.rainbird.com/rws>.



### Recommended

The tree is on a separate zone and there is full separation between the tree and the turf grass.

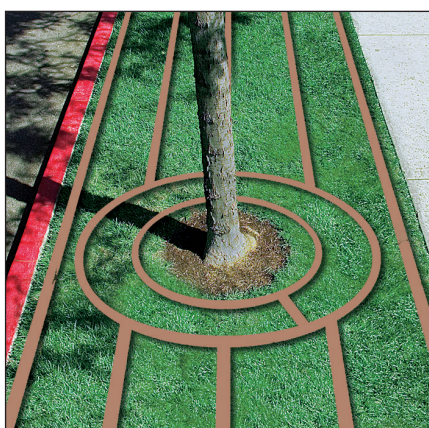

### Acceptable

Although the tree and turf grass are on the same zone, the buried dripline should be placed far enough away from the trunk so that tree roots do not push the dripline to the surface.

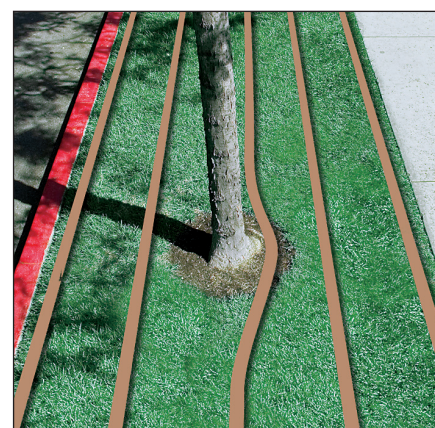

### Not recommended

There is no additional water for the tree. The dripline is close to the trunk and the tree roots will probably push the buried dripline up to the surface.

## ■ ADJUST FOR CURVED EDGES

**Curved Edges.** Rain Bird XFS/XFS-CV Dripline is flexible enough to follow curves that are 3 inch (7.6 cm) in radius and larger. When there are curved shapes in the landscape, avoid designing dripline rows that follow the curves. Instead, lay out as many straight lines as possible to simplify the installation, then fill in missed areas with additional straight lines if possible. When the landscape design layout is finished, make a grid pattern overlay to scale with the selected emitter and row spacing (for example, a grid that is 12 inches by 18 inches / 30.5 cm by 45.7 cm). Place the overlay on top of the design and check to be sure that at least one row and not more than two rows are found in each grid. This procedure ensures good uniformity in the design and avoids creating areas that may receive too much or too little water.

When installed on bare ground, specify Rain Bird stakes to hold tubing in place and secure the dripline with stakes every 5 feet (1.52 m) on straight runs; and every foot when following a curve of 4 foot (1.22 m) radius or less. Stakes are not required if the dripline is installed directly in the ground with mechanical equipment. (see page 53)



### Recommended



### Not Recommended



### ■ ADJUST FOR A CONFINED AREA

Small, confined areas represent a unique challenge when designing and installing a subsurface irrigation system. Below are step by step instructions to establish a grid layout and header design for a small, confined area similar to that shown in the photo.

### ■ LAY OUT THE FINAL GRID PATTERN, DESIGN THE SUPPLY HEADER, AND FLUSH HEADERS

Establish the overall grid concept. Generally, the least costly grid design is to place the header along the short dimension and design rows to run the length of the long dimension. This reduces the header material cost and will have fewer connections.

1. Identify the zone boundaries and show the direction of the dripline row.
2. Determine the maximum row length from Table 7 on page 29. The chart gives the maximum length for a given pressure at the lateral inlet (not the pressure available at the water source).
  - a. To choose the maximum row length at this step, estimate the inlet pressure available at the row that is farthest away from the water source.
  - b. Perform a pressure loss calculation from the water source to the farthest end of the header to confirm that all driplines will have adequate pressure. Be sure to account for changes in elevation.
3. Specify the distance from the edge of the zone to the first row in the grid.
  - a. For turf that is planted against a hardscape edge or curb, the first row should be 2 inches (5 cm) away from the edge.
  - b. For turf that is adjacent to a planted area, the first row should be 4 inches (10.2 cm) away from the edge.
4. Measure the widest part of the zone and specify the number of rows. (see page 15-16 for an example)
  - a. Find the widest zone dimension (in inches or centimeters).
  - b. Subtract the specified distance from both edges.
  - c. Divide by the spacing between rows, and round up to the nearest whole number.
  - d. Add 1 to this number to find the exact number of rows in the grid.
5. Design a header system that provides the pressure that was assumed in step B above to each of the rows.
  - a. For small areas with less than 8 GPM (30.28 L/M) total flow, the header can be made of polyethylene tubing, either with or without emitters.
  - b. For larger confined areas, divide the zone into subsections with no more than 8 GPM (30.28 L/M) flow and design a polyethylene header system for each of these subsections. Consider using QF Header.
6. Repeat the process at the opposite end of the zone to design flush headers and connect the flush headers to a manual or automatic valve so that the entire grid can be flushed regularly.



Establish the overall grid concept. For the most cost-effective design, the maximum row length determines the long dimension of the zone and the total available water flow determines the number of rows. Most large systems use a supply header in the middle of a zone and rows are installed in opposite directions from the center of the zone to reduce friction loss. (See Center Feed Layout diagram on page 15)

## ■ LAY OUT THE FINAL GRID PATTERN, DESIGN THE SUPPLY HEADER, AND FLUSH HEADERS

1. Determine the maximum row length from Table 7 on page 27. Estimate the inlet pressure at the row that is farthest away from the water source.
2. Calculate the flow rate of the longest row by multiplying the number of emitters by the flow rate of each emitter.
3. Divide the flow rate available at the water source by the flow rate of the longest row and round down to find the maximum number of rows that can be irrigated in one zone.
4. Design water supply and flush headers to supply the rows, using the spacing between rows as selected for the soil type. In large systems, large diameter PVC or poly pipe is often used to supply water to a riser that feeds rows in opposite directions.
  - a. Header designs should be specified with minimal friction loss to be sure of adequate pressure at the inlet of each lateral.
  - b. Headers should be designed to limit the water velocity to no more than 5 feet (1.5 m) per second to reduce friction loss, reduce long-term wear and hydraulic water hammer. (see Table 4 on page 21)
  - c. Perform a pressure loss calculation from the water source to the farthest end of the header to confirm that all driplines will have adequate pressure. Be sure to account for changes in elevation.
5. Specify air relief valves as per standard design practice for the large diameter water supply piping.
6. Repeat the process at the opposite end of the zone to design flush headers and connect the flush headers to a manual or automatic valve so that the entire grid can be flushed regularly.

### ■ SUBSURFACE INSTALLATION OPTION A: PRE-GRADED METHOD

- Remove the soil to a depth of at least 4 inches (10.2cm) below final grade; place the dripline on the soil surface
- Place the dripline grid on a uniform grade that is free of sharp rocks or other objects that may damage the dripline
- Make all connections to the supply header, flush header, flush valve, air relief valve, and control zone kit, then check for leaks before backfill
- Use tie-down stakes to keep the dripline in place while replacing backfill
- Be sure to compact the backfilled soil with rubber-tired machinery or a heavy roller. Some amount of compaction is required for water to move through the pores in the soil due to capillary action.



### ■ SUBSURFACE INSTALLATION OPTION B: VIBRATORY PLOW METHOD

- A single-shank or multi-shank vibratory plow can be used in new installations on bare soil, or to retrofit under existing turf
- This type installation method is less destructive to existing turf grass
- Be sure to cover the ends of the driplines after each pass to keep soil and debris from entering the lines before they are connected to the headers.





### ■ SUBSURFACE INSTALLATION OPTION C: ROTARY TRENCHING METHOD

- A rotary trenching unit cuts a narrow trench approximately 1 inch (2.54 cm) wide by 4 to 6 inches (10.2 cm to 15.24 cm) deep
- Suitable for installations in narrow or small existing turf grass applications
- Also suitable for subsurface shrub and ground cover installations



### ■ SUBSURFACE INSTALLATION OPTION D: HAND TRENCHING METHOD

- Hand trenching may be utilized in areas too small for mechanical installation
- Ideal for subsurface applications in turf grass and shrub bed installations with loamy or sandy soil
- Establish finish grade
- Hand dig trenches 4 to 6 inches (10.2 cm to 15.24 cm) deep to install XFS or XFS-CV subsurface dripline
- Cover trenches and rake level
- If installing shrubs or groundcover, maintain flags to identify dripline location during planting



### RECOMMENDED PRACTICES

1. Keep all driplines, headers (manifolds), and mainline piping free of dirt during installation because any contamination in these lines could plug the dripline emitters.
2. Check headers (manifolds) and dripline laterals for leaks before covering with soil.
3. Check pressure at the site and be sure to operate below the maximum rated pressure of 60 psi (4.14 bar). Check and record pressure at the supply header and flush header. Any changes in pressure can be used in future troubleshooting.
4. If core aeration is expected to be done in the turf where subsurface dripline is installed, be sure the tine depth is less than the depth of the buried dripline. Depth of dripline is recommended to be 6" (15.24 cm) while tine depth should not be set greater than 4" (10.2 cm).
5. When using machinery for the installation:
  - a. Do not drive over the dripline; always keep a layer of soil between the dripline and machinery tires.
  - b. To help keep driplines in place, drive in the same direction as the drip line, not across the lines.
  - c. Avoid driving in the same places at the site or you will be creating heavily compacted areas.
6. Be sure there is uniform soil compaction all over the site after installation.
7. After installation, open the flush valves (one at a time) and collect some of the water to check to be sure that the installation is clean.
8. After installation and backfill, observe the first wetting pattern. Rapid puddling could indicate a leak or might mean that the driplines are not buried at the specified depth.
9. Allow for expansion and contraction of tubing.

#### ↳ Conservative estimate of expansion and contraction:

Dripline will expand 0.1 inch per 100' for every 1° F of temperature change.

- **Example 1: 260' tubing length and 40° F temperature change**  
 $2.6 (100' \text{ lengths}) \times 0.1 (\text{in}/100') \times 40 (\text{degrees F}) = 10.4''$  or 1.5 cm per 100 meters for every 1° C of temperature change.
- **Example 2. 120 M tubing length and 5° C of temperature change**  
 $1.2 (100 \text{ m lengths}) \times 1.5 (\text{cm}/100 \text{ m}) \times 5 (\text{degree C}) = 9 \text{ cm}$



*Ensure that dripline depth is consistent throughout the installation*

**SECTION 8:** Specifying Products in The Zone





## QF Dripline Header™

THE INDUSTRY'S FIRST PRE-FABRICATED HEADER / EXHAUST  
*QUICK. FLEXIBLE. EASY. NOW THAT'S INTELLIGENT.*

The QF Dripline Header is an innovative product developed by the Rain Bird Xerigation®/Landscape Drip Division to be a replacement for site-built headers in dripline installations. Its performance characteristics match PVC in terms of flow and pressure ratings. This Quick and Flexible product was specifically designed to eliminate the high labor costs and hassle associated with site-built headers. The flexibility and durability of the QF Dripline Header makes it ideal for curved or non-linear landscapes, making installation quick and easy.

### Features

#### Performance

The QF Dripline Header has comparable design characteristics to a PVC header using the 5ft. per second rule. It has similar volume and pressure performance to ensure proper flow to the dripline grid or other drip irrigation systems.

#### Flexibility

Patent-pending QF Dripline Header is the ONLY coiled header on the market. Manufactured using a proprietary dual-layered polyethylene blend for optimal flexibility, this product is ideal for curved landscapes. Simply roll out, connect to a water source and attach the dripline; it's that simple.

#### 360° Pre-Installed XF Series Rotating Elbows

No other product has pre-installed elbows that ensure guaranteed spacing. The 360° rotating elbows allow for trenching misalignment – no need to re-trench, simply rotate the elbows slightly to accommodate the dripline. QF Dripline Header utilizes the XF Series Fitting elbow design, which requires 50% less force to insert – resulting in less hand and wrist fatigue. A protective ring surrounds the elbow, protecting it from damage and ensuring a proper seal. The ring also provides leverage when holding the elbow and attaching the dripline.

### Fittings Guide

The QF Dripline Header is designed to work with Rain Bird's TLF Series - Twist Lock Fittings (¾" and 1" models) which provide an even tighter seal on tubing by using high quality barbs and twist locking nuts.



### Specifications

#### ¾" Models

- **OD:** 0.940"
- **ID:** 0.820"
- **Wall thickness:** 0.060"
- **Elbow spacing:** 12" or 18" (30.5 cm or 45.7 cm)
- **Coil length:** 100' (30.5 m)
- **Coil color:** brown

#### 1" Models

- **OD:** 1.200"
- **ID:** 1.060"
- **Wall thickness:** 0.070"
- **Elbow spacing:** 12" or 18" (30.5 cm or 45.7 cm)
- **Coil length:** 100' (30.5 m)
- **Coil color:** brown or purple

### Operating Range:

- **Pressure:** 0 to 50 psi (0,0 to 4,14 bar)
- **Temperature:**
  - **Water:** Up to 100° F (37,8° C)
  - **Ambient:** Up to 125° F (51,7° C)

### Models

- XQF7512100:** XQF ¾" Dripline Header (12" Spacing 100' Coil)
- XQF7518100:** XQF ¾" Dripline Header (18" Spacing 100' Coil)
- XQF1012100:** XQF 1" Dripline Header (12" Spacing 100' Coil)
- XQF1018100:** XQF 1" Dripline Header (18" Spacing 100' Coil)
- XQF101210P:** XQF 1" Dripline Header (12" Spacing 100' Coil) Purple
- XQF101810P:** XQF 1" Dripline Header (18" Spacing 100' Coil) Purple



**Twist Lock Fittings - 800 Series**  
(For use on ¾" QF Dripline Header)



**Twist Lock Fittings - 1000 Series**  
(For use on 1" QF Dripline Header)

**DESIGN GUIDELINES FOR QF DRIPLINE HEADER**

**Determine pressure loss for any QF Dripline Header grid**

For situations where QF Dripline Header will be used in an irregular shaped layout, the pressure loss can be summed up by calculating the friction loss through each segment of QF Dripline Header. Since flow in the QF Dripline Header changes after each lateral, losses at each individual pipe segment must be calculated separately and then added together. Table 11 below gives the loss for the pipe flow in the QF Dripline Header for one segment (flow around one fitting and travel thru 12" or 18" of pipe length). Add these numbers to get the friction loss in the main pipe segment of QF Dripline Header. Then, look up the additional loss of travelling through the elbow using the small chart on the right. Add these two numbers together to get the pressure loss within the QF Dripline Header.\*

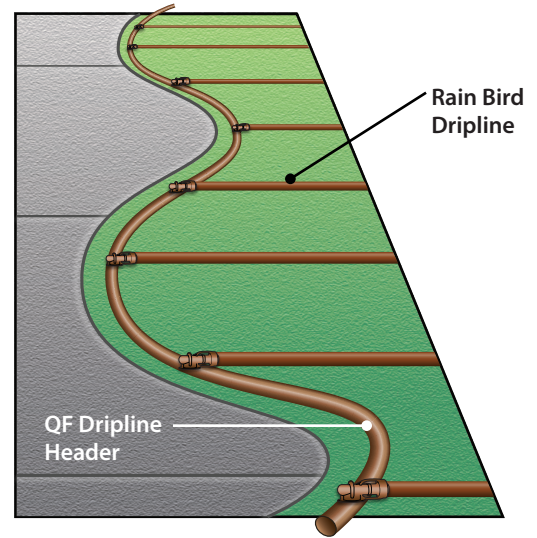

**TABLE 11: FRICTION LOSS THRU QF DRIPLINE HEADER**

		Friction Loss Through QF Dripline Header per Pipe Segment (psi)			
		3/4"		1"	
Product Size:		3/4"		1"	
Elbow Spacing:		12"	18"	12"	18"
QF Dripline Header Pipe Flow (GPM)	1.0	0.01	0.01	0.00	0.00
	2.0	0.02	0.03	0.00	0.00
	3.0	0.05	0.05	0.01	0.01
	4.0	0.07	0.08	0.01	0.01
	5.0	0.11	0.12	0.01	0.02
	6.0	0.15	0.16	0.02	0.02
	7.0	0.19	0.21	0.03	0.03
	8.0	0.24	0.27	0.04	0.04
	9.0	0.30	0.33	0.04	0.05
	10.0	0.36	0.41	0.05	0.06
	11.0	0.43	0.49	0.06	0.07
	12.0	0.51	0.57	0.08	0.09
	13.0			0.09	0.10
	14.0			0.10	0.11
	15.0			0.12	0.13
	16.0			0.13	0.15
	17.0			0.15	0.16
18.0			0.17	0.18	
19.0			0.19	0.20	
20.0			0.21	0.22	

**TABLE 12: FRICTION LOSS THRU INDIVIDUAL QF DRIPLINE HEADER ELBOW**

Friction Loss Through Individual QF Dripline Header Elbow (psi)		
Dripline Lateral Flow (GPM)	1.0	0.3
	2.0	1.3
	3.0	2.9
	4.0	5.1
	5.0	8.0

**Note:** Dark shaded area of chart indicates velocities over 5' per second. Use with caution.

\*Pressure loss charts are for flow thru QF Dripline Header only. Loss based on elevation changes, piping from valve etc. to be added separately.

### ■ EXAMPLE USING QF DRIPLINE HEADER PRESSURE LOSS TABLES



As an example, the system below uses a ¾" -12" QF Dripline Header and consists of four laterals. The first and last laterals flow at 3 GPM and the middle two laterals flow at 1 GPM. The example below shows how to calculate the Friction Loss in both the pipe and elbows.

- Step 1:** Prepare your design and calculate flow rates per lateral.
- Step 2:** List and determine the friction loss for each pipe segment.
- Step 3:** List and add the additional friction loss at each elbow.
- Step 4:** Calculate the total friction loss at the inlet to each lateral.

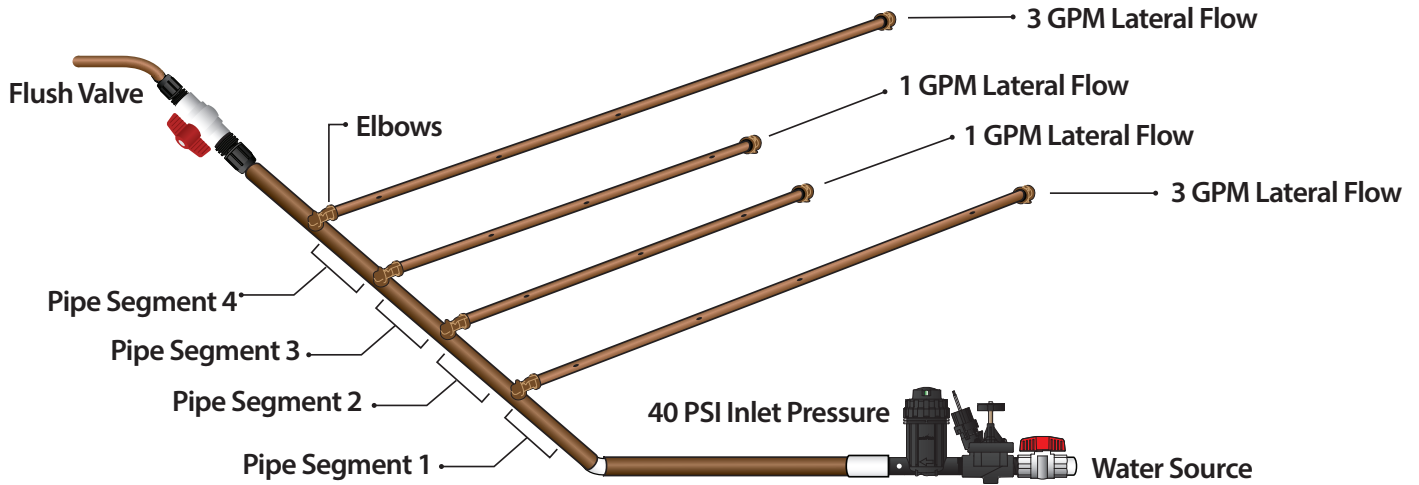

	Pipe Segment Friction Loss (psi)	Elbow Friction Loss (psi)	Total Friction Loss at Lateral Inlet (psi)	Available Water Pressure at Lateral Inlet (psi)
Lateral #1 (3 GPM Flow)	0.24 psi	2.9 psi	3.14 psi	36.86 psi
Lateral #2 (1 GPM Flow)	0.11 psi	0.30 psi	0.41 psi	36.45 psi
Lateral #3 (1 GPM Flow)	0.07 psi	0.30 psi	0.37 psi	36.08 psi
Lateral #4 (3 GPM Flow)	0.05 psi	2.9 psi	2.95 psi	33.13 psi

## ■ CONTROL ZONE KITS



Rain Bird Control Zone Kits provide all of the components necessary for on/off control, filtration and pressure regulation of a low-volume irrigation zone, making the kits simple to order and easy to install.

## ■ KIT FEATURES



### LOW FLOW VALVES

Featured on the following models:  
**XCZ-075-PRF and XCZ-LF-100**

- The only valve on the market hat can handle flow rates as low as 0.2 GPM without without weeping (Low Flow DV Drip Valve)



### ANTI-SIPHON VALVE

Featured on the **XACZ-075-PRF** and **XACZ-100-PRF** models

- Field-proven low flow anti-siphon valve that has an atmospheric vacuum breaker for backflow prevention and an IAPMO rating

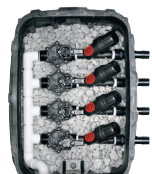

### COMPACT SIZE

- With only two components (valve plus pressure regulating filter) you can fit more Control Zone Kits in a valve box, saving time and money



### PR FILTER KITS

Featured on the following models:  
**XCZLF-075-PRF, XCZ-075-PRF, XACZ-075-PRF, XCZPGA-100-PRF, XCZ-100-PRF, XACZ-100-PRF**

- All of these kits provide on/off control, filtration, and built-in pressure regulation with fewer components so there is less chance of leakage at the connections, both at installation and over the life of the system

## QUICK-CHECK FILTER WITH PRESSURE REGULATION AND FILTRATION ALL IN ONE



**GREEN INDICATES A CLEAN FILTER**



**RED INDICATES A DIRTY FILTER**



Featured on the following models: **XCZ-100-PRB-COM**

- Save labor and time with the simple-to-check indicator bubble and easy-to-clean stainless steel screen
- The product design allows the internal filter screen element to be accessed vertically while preventing debris from falling into the line
- Efficient design combines filtration and pressure regulation in one compact unit
- Fewer connection points mean less chance of leaking and less assembly time
- The body is made of durable, glass filled nylon
- Replacement stainless steel screens also available separately in 100, and 200 mesh

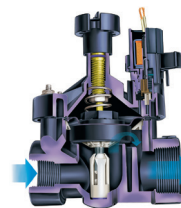

### SCRUBBER VALVE

Featured on the following models:

- **XCZ-100-PRB-COM,**
- **XCZ-100-PRB-R**
- **XCZ-150-LCDR**

- Plastic scrubber scrapes the stainless steel screen to clean and break down grit and organic materials
- Slow closing prevents water hammer and subsequent system damage
- Fabric-reinforced diaphragm adds strength and durability

## CONTROL ZONE KIT SELECTION GUIDE

This easy-to-use selection tool is available at [www.rainbird.com/CZK](http://www.rainbird.com/CZK) and will help identify the most appropriate Control Zone Kit for the application.

### Commercial High Flow: 15 - 62 GPM



2-Wire  
Compatible

**X CZ-150-LCS**  
FLOW: 15 - 62 GPM



2-Wire  
Compatible

**X CZ-150-LCDR**  
FLOW: 15 - 62 GPM

### Commercial Wide Flow: 0.3 - 20 GPM



2-Wire  
Compatible

**X CZ-100-PRB-COM**  
FLOW: 0.3 - 20 GPM



2-Wire  
Compatible

**X CZ-100-PRBR**  
FLOW: 0.3 - 20 GPM



2-Wire  
Compatible

**X CZ-100-PRB-LC**  
FLOW: 0.3 - 20 GPM

UPDATED

### Residential Medium Flow: 3 - 15 GPM



2-Wire  
Compatible

**X CZPGA-100-PRF**  
FLOW: 3 - 15 GPM



**X CZ-100-PRF**  
FLOW: 3 - 15 GPM



**X ACZ-100-PRF**  
FLOW: 3 - 15 GPM

### Residential Low Flow: Flow: 0.2 - 10 GPM



**X CZLF-100-PRF**  
FLOW: 0.2 - 10 GPM

### Residential Low Flow: Flow: 0.2 - 5 GPM



**X CZ-075-PRF**  
FLOW: 0.2 - 5 GPM



**X ACZ-075-PRF**  
FLOW: 0.2 - 5 GPM



## FITTINGS

Rain Bird offers a complete fittings solution set for the entire dripline system. All fittings are designed to deliver a secure connection with features which allow for easy installation.

### ■ XF DRIPLINE INSERT FITTINGS



Rain Bird's 17mm Insert Fittings have a barbed end that is raised and sharp providing a strong connection. This fitting is rated for operating pressures up to 50 psi (3.45 bar) without using clamps. If operating pressures exceed 50 psi (3.45 bar), a clamp is recommended. To install, the fittings are pressed into the tubing. It is important you do not heat the polyethylene tube before inserting to make installation easier, as it will weaken the connection and can damage the tubing. For the full line of insert fittings, refer to our product catalog or visit the website at: <http://www.Rainbird.com/professionals/products/drip-distribution>



#### Features:

- Complete line of 17mm insert fittings to simplify installation of XF Series Dripline
- High quality barbs grab tubing for a secure fit
- Unique barb design to reduce insertion force and still retain a secure fit
- Non-obtrusive colored fittings to complement natural earth tones

#### Models



**Model:**  
XFF-COUP  
**Description:**  
17mm Barb x Barb Coupling



**Model:**  
XFF-ELBOW  
**Description:**  
17mm Barb x Barb Elbow



**Model:**  
XFF-MA-050  
**Description:**  
17mm Barb x 1/2" MPT Male Adapter



**Model:**  
XFF-FA-050  
**Description:**  
17mm x 1/2" FPT



**Model:**  
XFF-TEE  
**Description:**  
17mm Barb x Barb x Barb Tee



**Model:**  
XFF-TMA-050  
**Description:**  
17mm Barb x 1/2" MPT x 17mm Barb Tee Male Adapter



**Model:**  
XFF-MA-075  
**Description:**  
17mm Barb x 3/4" MPT Male Adapter



**Model:**  
XFF-TFA-050  
**Description:**  
17mm x 1/2" FPT x 17mm

#### Also Available



**Model:**  
XFD-CROSS  
**Description:**  
Barb Cross 17mm x 17mm x 17mm x 17mm



**Model:**  
XFD-TFA-075:  
**Description:**  
Barb Female Adapter 17mm x 3/4" FPT x 17mm



**Model:**  
XFD-FA-075:  
**Description:**  
Barb Female Adapter 17mm x 3/4" FPT

### ■ XF SERIES | INSERTION TOOL

Rain Bird's XF Insertion Tool assists you with installing XF Series 17 mm Fittings in less time with less effort. The XF Insertion Tool securely locks fittings into place to make inserting into dripline much easier. The handles on either side of the tool can be used to flair out the ends of the dripline. The tool also has a sloped valley to allow room for the dripline when inserting onto the second side.

**Model:**  
FITINS-TOOL

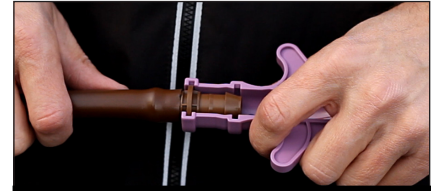

**Compatibility:**

Insertion tool can be used to install XF Coupling, Elbow, and Tee fittings.



### ■ XF SERIES | EASY FIT COMPRESSION FITTINGS (FOR ON-SURFACE USE ONLY)

Rain Bird patented Easy Fit compression fittings go together with half the force as insert fittings and can be used for on-surface dripline and tubing with diameters from 16 to 17mm OD. Snap-in adapters provide versatility to eliminate the inventory of over 160 combinations of connections. The Easy Fit compression fittings provide a stronger connection and can be used with operating pressures up to 60 psi (4.14 bar). For the full line of Easy Fit fittings, refer to our website at <https://www.rainbird.com/products/easy-fit-compression-fitting-system> or consult a Rain Bird product catalog.



**Model:** MDCF-50-MPT

**Description:**  
1/2" MPT x Compression adapter for easy fit fitting



**Model:** MDCF-75-MPT

**Description:**  
3/4" MPT x Compression adapter for easy fit fitting



**Model:** MDCF-EL

**Description:**  
16mm Compression x Compression Elbow



**Model:** MDCF-50-FPT

**Description:**  
1/2" FPT x Compression adapter for easy fit fitting



**Model:** MDCF-75-FPT

**Description:**  
3/4" FPT x Compression adapter for easy fit fitting



**Model:** MDCF-TEE

**Description:**  
16mm Compression x Compression Tee



**Model:** MDCF-75-FHT

**Description:**  
3/4" FHT x Compression adapter for easy fit fitting



**Model:** MDCF-COUP

**Description:**  
16mm Compression x Compression Coupling



**Models:** MDCF-CAP (Black)  
MDCFP-CAP (Purple)

**Description:**  
Use Caps to shut off MDCF-COUP, MDCF-EL or MDCF-TEE

**■ TWIST LOCK FITTINGS (TLF)**

Rain Bird's complete line of Twist Lock Fittings simplify the installation of all industry-standard 1/2", 3/4" and 1" tubing. They provide an even tighter seal on tubing by using high quality barbs and twist-locking nuts. Their unique barb design reduces insertion force while maintaining a secure fit.

**Operating Range**

- Pressure: 0 to 60 psi (0 to 4.1 bar)



**Models**

**600 SERIES:**

- TLF-CUPL-0600: Twist Lock Fitting 1/2" Coupler
- TLF-TEE-0600: Twist Lock Fitting 1/2" Tee
- TLF-ELBW-0600: Twist Lock Fitting 1/2" Elbow
- TLF-MPT6-0600: Twist Lock Fitting 1/2" NPT to 1/2" Adaptor
- TLF-MPT8-0600: Twist Lock Fitting 3/4" NPT to 1/2" Adaptor

**800 SERIES:**

- TLF-CUPL-0800: Twist Lock Fitting 3/4" Coupler
- TLF-TEE-0800: Twist Lock Fitting 3/4" Tee
- TLF-ELBW-0800: Twist Lock Fitting 3/4" Elbow
- TLF-MPT8-0800: Twist Lock Fitting 3/4" NPT Adaptor
- TLF-CAP-0800: Twist Lock Fitting 3/4" Cap

**1000 SERIES:**

- TLF-CUPL-1000: Twist Lock Fitting 1" Coupler
- TLF-TEE-1000: Twist Lock Fitting 1" Tee
- TLF-ELBW-1000: Twist Lock Fitting 1" Elbow
- TLF-MPT8-1000: Twist Lock Fitting 1" NPT Adaptor

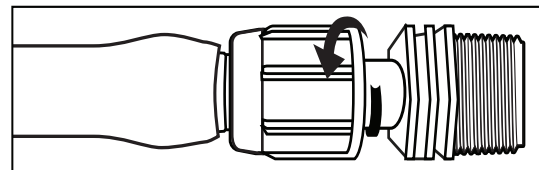
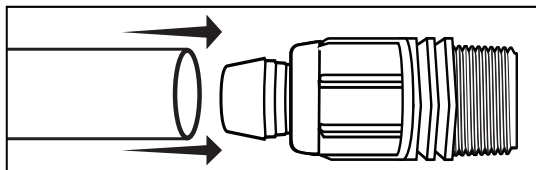

**2 Step Installation**

	600 Series		800 Series		1000 Series	
	Inches	mm	Inches	mm	Inches	mm
Acceptable Internal Diameter	0.590 to 0.630	15 to 16	0.790 to 0.845	20.0 to 21.5	1.025 to 1.085	26.0 to 27.6
Acceptable Wall Thickness	0.025 to 0.050	0.64 to 1.27	0.045 to 0.065	1.14 to 1.65	0.045 to 0.065	1.14 to 1.65
Compatible Tubing	XT700, 1/2" XBS		3/4" XBS, 3/4" QF Dripline Header		1" QF Dripline Header	



### ■ SPRAY-TO-DRIP RETROFIT KIT

The easiest and fastest way to convert a conventional spray zone to a low-volume irrigation zone.



### INSTALLATION

- Simply remove the top of any 1800 and remove the internal assembly (on the 1806 and 1812 leave the spring in the body)
- Remove the internal assembly of the retro kit and drop it into the existing body
- Tighten the cap
- Cap off all other spray heads in the zone using Xeri-Caps™ (sold separately)
- 1/2" FPT x Elbow Fitting and (1) 1/2" FPT x Tee Fitting for easy connection to drip tubing

### FEATURES

- Can be installed above or below grade.
- Provides 30 psi (2.1 bar) pressure regulation and 200 mesh (75 microns) screen
- **Flow rate:** 0.50 to 6.00 GPM



### ■ CURRENT APPLICATION

#### Products

- Overhead sprays

#### Issues

- Overspray damage to structure, fence, windows
- Water loss to wind
- Runoff liability in high traffic areas

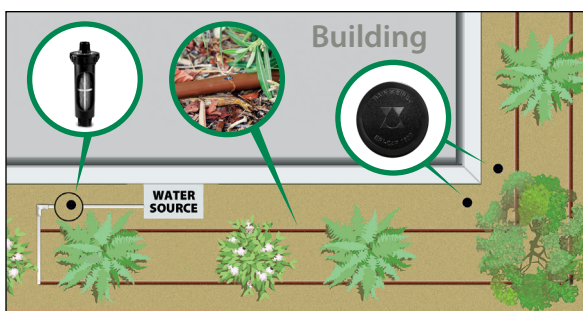

### ■ DRIP SOLUTION

#### Products

- Retrofit Kit (1800-Retro)
- XF Series Dripline
- 17mm XF Insert Fittings

#### Advantages

- Reduce the effects of wind and evaporation by 30%-70%
- No runoff
- No overspray damage
- Easy to install

## ■ AIR/VACUUM RELIEF VALVES

Air/Vacuum Relief Valves are used for two reasons:

- To allow air into a zone at the end of a watering cycle. This ensures a vacuum doesn't draw debris into the dripline. (back siphoning)
- To ensure release of air from a zone at the start of watering, eliminating air pockets. This speeds fill time, thus increasing watering uniformity across the zone.

Install Air/Vacuum Relief Valves correctly by:

- Install at the highest point(s) of the dripline zone.
- Install the valve in an exhaust header or a line that runs perpendicular to the lateral rows to ensure all rows of the dripline can take advantage of the air/vacuum relief valve.



SEB 7XB emitter box (Sold Separately)



**1/2" Air Relief Valve**

**Model:**  
ARV050

## ■ TABLE 10: LATERAL RUN LENGTHS

Maximum length of dripline that can be used with the Air Relief Valve (ARV)

	1/2" ARV	
<b>Emitter Spacing</b>	0.6 GPH	0.9 GPH
<b>12"</b>	639 ft	424 ft
<b>18"</b>	958 ft	636 ft

### Air Relief Valve capacity

	1/2" ARV
<b>Total Flow (GPM)</b>	6.5
<b>Total Flow (GPH)</b>	390

ARV should be installed at the high points in the drip zone for proper operation and to reduce the risk of back siphoning.

## ■ TIE-DOWN STAKES



XF Series tie-down stakes are made of long lasting corrosion resistant 9-gauge galvanized steel. Use stakes to hold dripline on-surface or under a mulch cover. For best results, stagger stakes every 3 feet (.91 m) in sand, 4 feet (1.22 m) in loam, and 5 feet (1.52 m) in clay. At fittings where there is a change of direction such as tees or elbows, use tie-down stakes close to the fitting on each leg of the change of direction.

**Models:**  
TDS6050  
TDS6500

## ■ MANUAL LINE FLUSH POINT

A manual flush point is necessary to flush the system after installation and maintenance. The flush point is also necessary when emptying the system for winter.

- Install the manual flush at a low point in the exhaust header of a grid layout, or at the mid-point of a Loop Layout. (see pages 15,16)
- Install a flush port with a threaded plug or a manual flushing valve in a valve box with a gravel sump adequate to drain approximately one gallon of water
- Manual flush points are normally installed as far away from the water source as possible



### ■ DRIP SYSTEM OPERATION INDICATOR

#### Features

- Stem rises 6" (15 cm) for clear visibility
- When stem is fully extended, drip system is charged to a minimum of 20 psi
- Includes 16" of ¼" distribution tubing with ¼" connection fitting pre-installed
- Operational Indicator Kit includes three different indication caps; potable, non-potable, or an adjustable 4-VAN nozzle
- VAN nozzle is tightened to no flow but can be opened to observe wetting pattern

#### Model

- OPERIND

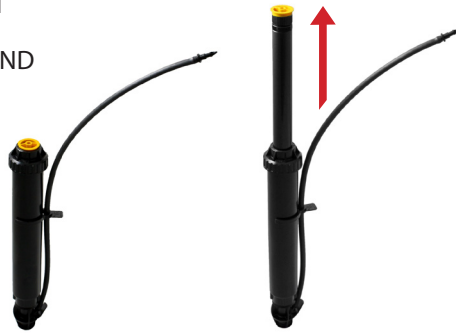

System is OFF

System is ON



4-VAN  
Nozzle

Potable  
Cap

Non-potable  
Cap



#### Installation of Operation Indicator with XFD On-Surface Dripline

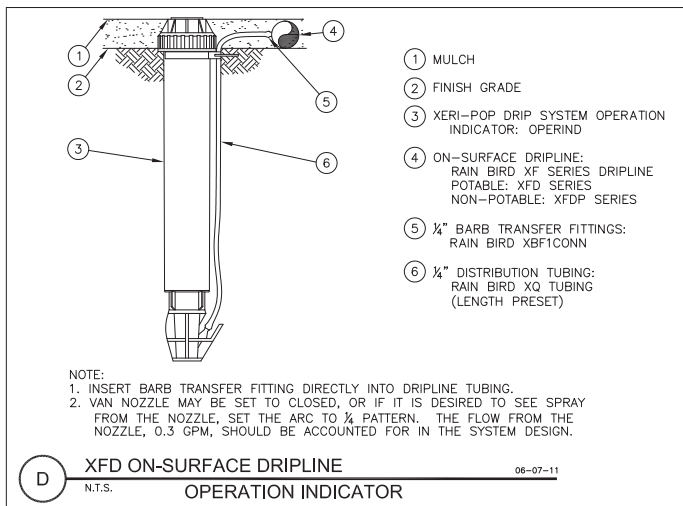

#### Installation of Operation Indicator with XFS Subsurface Dripline

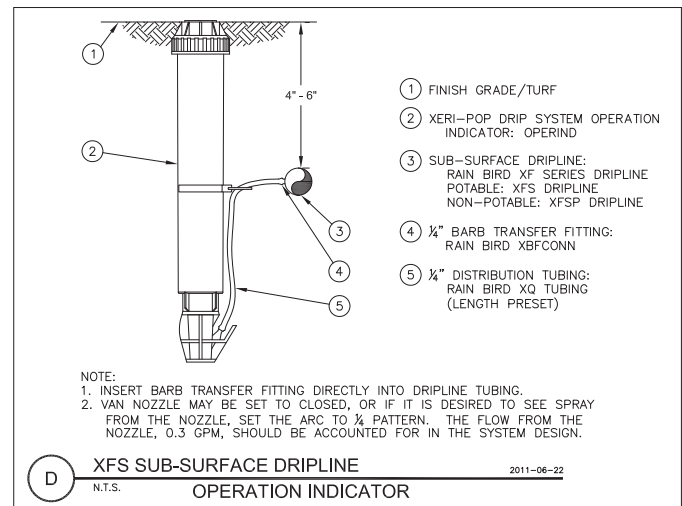

**SECTION 9: FAQ's, Glossary and Resources**



### PREVENTATIVE MAINTENANCE

#### ■ FLUSHING

- Flush the system every two weeks for the first 6 weeks and check the water that is flushed out for cleanliness
- Establish a regular flush schedule for the future after these initial checks
- Flush the system well after any repairs are made
- Check the pressure at the supply and flush headers on a regular basis and compare with the pressure readings taken right after installation

#### ■ WINTERIZING

- Winterizing an irrigation system involves removing enough water to ensure that components are not damaged due to freezing weather
- Check the manufacturer's instructions for winterizing the valves, filters and backflow prevention devices

#### If compressed air is used to blowout the lines:

- Compressed air may only be used with the flush valve open and with the air pressure at 40 psi (2.76 bar) or less
- XF Dripline Insert Fittings are rated to 50 psi (3.45 bar), so the air pressure must be adjusted below this pressure
- It is air volume, not pressure, which is effective when blowing out the lines
- The pressure-regulating valve that is part of the control zone regulates water, not air pressure
- With all flush valves open, compressed air should be applied until no water is seen exiting the flush valves
- After turning off the air, close all flush valves

#### If compressed air is not used to blowout the lines:

- A drain port should be installed at all low points in the zone. These ports may be a tee or elbow with a threaded plug or a manual flush valve
- If the zone is in a grid or closed loop system, the headers may contain a significant amount of water because they are either QF Header, blank XF Series tubing, PVC, or poly pipe. It is important to provide drain ports for these components
- If the zone has laterals that dead-end and are not connected to an exhaust header, the lateral ends should be opened to drain at the lowest point(s)

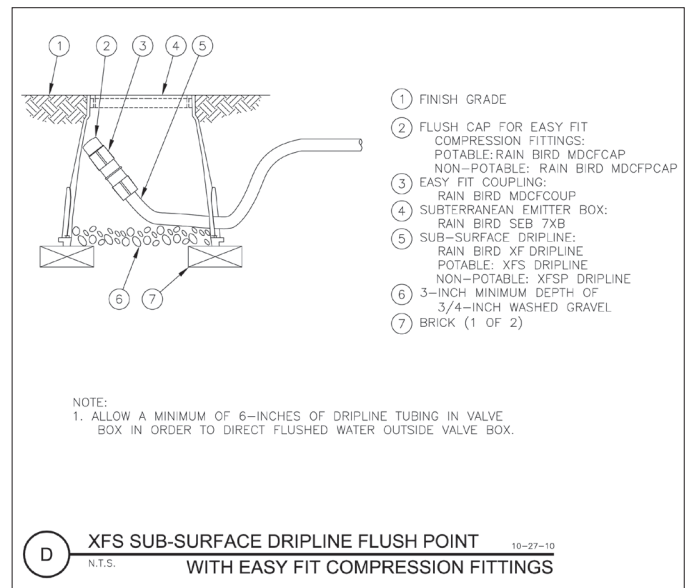



**SPECIFICATIONS**

**■ WRITTEN SPECIFICATIONS AND CAD DETAIL DRAWINGS**

Rain Bird's technical specifications for commercial products are now available in Microsoft Word format. For your convenience, these technical specifications can be easily edited or cut and pasted into your documents and drawings, saving you time and money.

**Visit written specifications page:**

<https://www.rainbird.com//professionals/specifier-design-resources-product-page>

Rain Bird CAD Detail Drawings for Landscape Irrigation products are now available in four popular formats: DWG for AutoCAD users, DXF for importing into alternate CAD programs, JPG for most web browsers and Microsoft Office users and PDF for printing and emailing to clients.

**Visit CAD drawings page:**

<https://www.rainbird.com//professionals/specifier-design-resources-product-page>

**Sample CAD Drawing**

**Legend:**

- ① PVC SUPPLY PIPE FROM RAIN BIRD CONTROL ZONE KIT (SIZED TO MEET LATERAL FLOW DEMAND)
- ② PERIMETER OF AREA
- ③ PERIMETER DRIPLINE PIPE TO BE INSTALLED 2"-4" FROM PERIMETER OF AREA
- ④ PVC SUPPLY MANIFOLD
- ⑤ PVC SCH 40 TEE OR EL (TYPICAL)
- ⑥ BARB X MALE FITTING: RAIN BIRD XFD-MA FITTING (TYPICAL)
- ⑦ SUB-SURFACE DRIPLINE: RAIN BIRD XF SERIES DRIPLINE (TYPICAL)  
POTABLE: XFS DRIPLINE  
NON-POTABLE: XFSP DRIPLINE
- ⑧ BARB X BARB INSERT TEE: RAIN BIRD XFD-TEE (TYPICAL)
- ⑨ TOTAL LENGTH OF SELECTED DRIPLINE SHOULD NOT EXCEED LENGTH SHOWN IN TABLE
- ⑩ PVC EXHAUST HEADER
- ⑪ FLUSH POINT: SEE RAIN BIRD DETAIL "XFS FLUSH POINT"
- ⑫ PVC SCH 40 RISER PIPE
- ⑬ TURF OR MULCH
- ⑭ FINISH GRADE
- ⑮ AIR RELIEF VALVE: RAIN BIRD AR VALVE KIT XXX  
SEE RAIN BIRD DETAIL "XFS AIR RELIEF VALVE KIT"

**NOTES:**

1. DISTANCE BETWEEN LATERAL ROWS AND EMITTER SPACING TO BE BASED ON SOIL TYPE, PLANT MATERIALS AND CHANGES IN ELEVATION. SEE INSTALLATION SPECIFICATIONS ON RAIN BIRD WEB SITE (WWW.RAINBIRD.COM) FOR SUGGESTED SPACING.
2. LENGTH OF LONGEST DRIPLINE LATERAL SHOULD NOT EXCEED THE MAXIMUM SPACING SHOWN IN THE ACCOMPANYING TABLE.

PSI	XFS Dripline Maximum Lateral Lengths (Feet)					
	12" Spacing		18" Spacing		24" Spacing	
	0.6 GPH	0.9 GPH	0.6 GPH	0.9 GPH	0.6 GPH	0.9 GPH
15	273	155	314	250	424	322
20	318	169	353	294	508	368
30	360	230	413	350	586	414
40	395	255	465	402	652	474
50	417	285	528	420	720	488
60	460	290	596	455	780	512

WHEN USING 17MM INSERT FITTINGS WITH DESIGN PRESSURE OVER 50PSI, IT IS RECOMMENDED THAT STAINLESS STEEL CLAMPS BE INSTALLED ON EACH FITTING.

**D** XFS SUB-SURFACE DRIPLINE  
N.T.S. TYPICAL ODD CURVES LAYOUT 3-17-11

XFS Dripline Odd Curves Layout.dwg

## FREQUENTLY ASKED QUESTIONS

### ***Where can I use XF Series Dripline?***

This design guide outlines all of the XF series driplines for use in any on-surface or subsurface landscape irrigation application.

### ***How do I know if the drip system is actually working?***

A Drip System Operation Indicator (OPERIND) can be installed on a XF Series Dripline zone. During operation the OPERIND will provide a visual indication that the drip zone is performing as designed. (see page 54)

### ***What can I expect to achieve in regards to water savings?***

It is generally accepted that drip irrigation is over 90% efficient. It delivers water directly to the plant root zone. Also, when compared to sprinklers, drip irrigation can save water by reducing the effects of wind and evaporation from 30% to 70%.

### ***Can XF Series Dripline be used with reclaimed (non-potable) water?***

Yes. XF Series dripline is available in full purple and purple stripe for non-potable water.

### ***What is the life expectancy of the system?***

XF Series dripline is made of a dual-layered tubing that provides unmatched resistance to chemicals, algae growth and UV damage. With good design, installation and maintenance an XF Series dripline system will provide many years of reliable service. Like any irrigation system, a drip zone should be inspected regularly to insure that filters are clean and that the system is working properly.

### ***How does the Rain Bird Copper Shield™ work?***

Rain Bird's Copper Shield™ protects the emitter from root intrusion without harming the plants or other roots. When a root tries to intrude into the emitter, it comes in close proximity to the Copper Shield™ and copper ions are released. These copper ions bind themselves to the attacking root tip and stop it from advancing, thus protecting the emitter.

### ***Will I see striping in turf irrigated with Subsurface dripline?***

A well designed, installed and maintained XFS subsurface dripline system will provide years of superior turfgrass quality while using significantly less water.

### ***Will the XFS Copper Shield™ work if it oxidizes?***

If the Copper Shield™ oxidizes, these oxides continue to have copper in them. The emitter continues to be protected because of the copper ions that are still present in the oxidized Copper Shield™.

### ***How long will the copper last?***

Testing shows that on average Copper Shield™ will exceed 16 years of life.



**Rain Bird's Professional  
Customer Satisfaction Policy**

**XF Series Dripline offers five (5) years on product workmanship  
and seven (7) years on environmental stress cracking**

## FREQUENTLY ASKED QUESTIONS

### ***What if I need to aerate?***

Subsurface drip irrigation can greatly reduce or eliminate the need for aeration. If core aeration is expected to be done in the turf where subsurface is to be installed, be sure the tine depth is less than the depth of the buried dripline. If core aeration is used, consider installing the dripline at 6" deep and using an aeration tine depth no greater than 4".

### ***How do I fertilize my turfgrass areas with an XFS Subsurface drip irrigation system?***

There are a variety of methods to fertilize turfgrass areas including the following:

- Initiate a manual start on the irrigation controller for the turfgrass zones to bring water to the surface and begin to move the fertilizer into the soil structure
- Apply hand watering to the turfgrass areas to water in the fertilizer
- Apply fertilizer prior to a rainfall event
- Consider the use of fertilizer injection system to provide nutrients to the on-surface shrub bed areas as well as the subsurface turf areas

### ***Can I establish sod with Subsurface Drip Irrigation?***

An XFS subsurface dripline system is no different than a spray head or rotary zone in this regard. Initial water time and frequency should be programmed appropriately to allow for the establishment of new sod. As with conventional sprinkler systems, some supplemental hand watering may be needed to provide coverage to isolated "hot" spots during the establishment period.

### ***Where can I find out more about Rain Bird XF Series Dripline?***

For additional information on the XF Series family of dripline products please visit [www.rainbird.com](http://www.rainbird.com).

## GLOSSARY

**Aerated (aeration)** – The act of creating holes in the turfgrass to loosen the soil and get oxygen to the underground roots.

**Application Rate** – A measurement of the amount of water added to a zone over a certain amount of time, often reported in inches per hour.

**Back Siphoning** – The reverse flow of water from the soil into the emitter outlet hole. This can happen when there is no check valve or vacuum air relief valve, and water drains out of low-elevation emitters creating a back siphon that pulls water into the emitters at higher levels.

**Capillary Action** – The movement of water through the soil where the water sticks to the sides of very small passages or capillaries between soil particles.

**Center Feed** – This layout allows you to increase the size of the zone by providing lateral runs on both sides of the supply header which is located in the center.

**Dripline** – Polyethylene tubing with emitters pre-inserted at various intervals; usually 12" or 18".

**Dynamic Pressure** – The pressure as measured when water is flowing in the system.

**Emitter** – The device inside the dripline that controls the amount of water flow out of each outlet hole.

**Emitter Check Valve** – A built-in feature of a dripline emitter which allows water to flow in one direction only. Used to prevent drainage at the lowest point in the zone.

**End Feed** – A typical layout that uses supply headers and flush headers with rows of dripline connected between them.

**Flow Rate** – The amount of water that travels through the pipes or the emitters in a given amount of time. Flow rate is normally measured in gallons per minute (GPM) or gallons per hour (GPH).

**Flush Header** – Flexible or rigid pipe and fittings connecting a group of dripline rows and found at the opposite end of the Supply Header (also known as "manifold").

**Flush Valve** – A valve that can be opened automatically or manually to discharge the water that is in the system of dripline rows and headers to remove any accumulated dirt or debris.

**Friction Loss** – The reduction in pressure caused by water flowing in a pipe because of friction created when the flowing water slides against the inside walls of the pipe or tubing.

**Hold Back** – The ability of an emitter with built-in check valve to keep dripline charged with water up to a certain elevation change.

**Pores** – The small spaces between soil particles that water can move into (see Capillary Action).

**Precipitation Rate** – A measurement of the amount of water added to a zone over a certain amount of time, often reported in inches per hour (same as Application Rate).

**Riser** – A pipe or tube that carries water upward from a buried water supply pipe to a fitting or sprinkler.

**Run Time** – The amount of time that the valve is open and water is delivered to an irrigated area.

**Static Pressure** – The pressure as measured when there is no flow in the system.

**Supply Header** – The combination of flexible or rigid pipe plus fittings that supplies water to many rows of dripline (also known as “manifold”).

**Zone** – A part of the landscape that gets irrigated at the same time.

**NOTES**SECTION 1  
SECTION 2  
SECTION 3  
SECTION 4  
SECTION 5  
SECTION 6  
SECTION 7  
SECTION 8  
SECTION 9

---

---

---

---

---

---

---

---

---

---

---

---

---

---

---

---

---

---

---

---

---

---

---

---

---

---





## The Intelligent Use of Water™

LEADERSHIP • EDUCATION • PARTNERSHIPS • PRODUCTS

At Rain Bird, we believe it is our responsibility to develop products and technologies that use water efficiently. Our commitment also extends to education, training and services for our industry and our communities.

The need to conserve water has never been greater. We want to do even more, and with your help, we can. Visit [www.rainbird.com](http://www.rainbird.com) for more information about The Intelligent Use of Water.™



**Rain Bird Corporation**  
970 West Sierra Madre Avenue,  
Azusa, CA 91702, U.S.A.  
Phone: (626) 812-3400  
Fax: (626) 812-3411

**Rain Bird Technical Services**  
(800) RAINBIRD (1-800-724-6247)  
(U.S. and Canada)

**Rain Bird Corporation**  
6991 East Southpoint Road,  
Tucson, AZ, 85706, U.S.A.  
Phone: (520) 741-6100 Fax: (520)  
741-6522

**Specific Hotline**  
(800) 458-3005 (U.S. and Canada)

**Rain Bird International, Inc.**  
1000 West Sierra Madre Avenue,  
Azusa, CA 91702, U.S.A.  
Phone: (626) 963-9311  
Fax: (626) 852-7343

[www.rainbird.com](http://www.rainbird.com)