

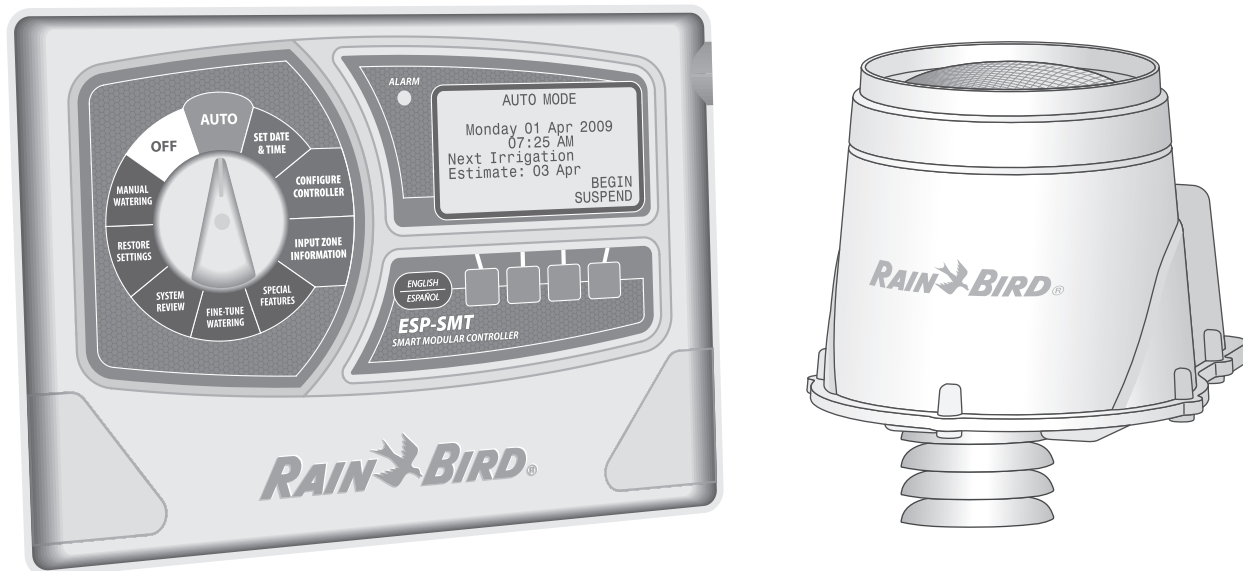

ESP-SMT Smart Modular Control System

Quick Installation & Setup Guide

(for ESP-SMT panels with a March 31, 2011 date code or newer)



Welcome To The Rain Bird ESP-SMT Smart Control System

The Rain Bird ESP-SMT "Smart" Modular Control System has many advanced features based on scientific agronomic principles. It is designed for you to easily and conveniently keep your client's landscape healthy and vibrant by optimizing the irrigation schedule to match the plant water needs associated with changing weather conditions.

You are about to install a controller that many of our field test participants commented that this control system is what they need to irrigate correctly and save water. They also stated that this controller is much easier and faster to program than any other controller they have used.

To leverage the water savings potential of the ESP-SMT control system, it is important that you become familiar with both the basic as well as advanced capabilities of the controller. If you would like to better understand Plant-Soil-Water relationship principles or learn more about how to maximize the water savings and your profits with the ESP-SMT Smart Control System, we offer a free, comprehensive on-line tutorial program. To learn more, visit the Rain Bird website... www.rainbird.com

Thank you for doing your part to conserve our most precious natural resource... WATER!

Box Contents and Required Tools

Box Contents

- ESP-SMT Controller (or retro-fit panel only)
- * Controller Mounting Hardware
- * Controller Mounting Template
- ESP-SMT Installation & Operation Guide
- ESP-SMT Site Profile Chart
- ESP-SMT Installation & Quick Setup Poster
- SMT Weather Sensor
- Weather Sensor Debris Screen
- Weather Sensor Mounting Bracket
- Mounting Bracket Hardware
- Sensor Wire - 25 feet of 20-2 UV rated wire (not rated for direct burial)
- * Controller models only

Installation Tools (not shown)

- Phillips slot-head screwdriver
- Marking pencil for template
- Wire stripper
- Torpedo level
- Drill bit & hammer drill
- Ladder (if mounting sensor more than 6' above grade)

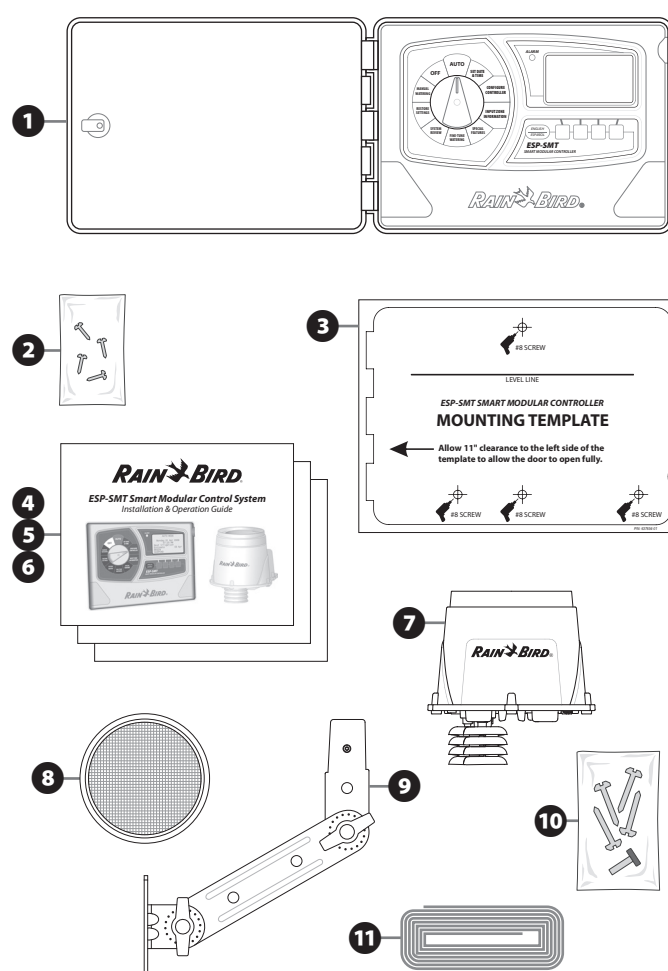

Locate The Sensor

Do's

- Install sensor in a location that receives afternoon sun in order to measure the daily high temperature (South or West exposure is ideal).
- Mount weather sensor at least six feet above grade.
- Assure that sensor is free from obstructions to allow for collection and accurate measurement of rainfall.

Don't's

- Do NOT install sensor in a location where spray from the sprinkler will collect in the sensor.
- Do NOT install the sensor where it will be located in the shade during the hottest part of the day.
- Do NOT install the sensor where rainfall will be blocked from collection and accurate measurement of rainfall.

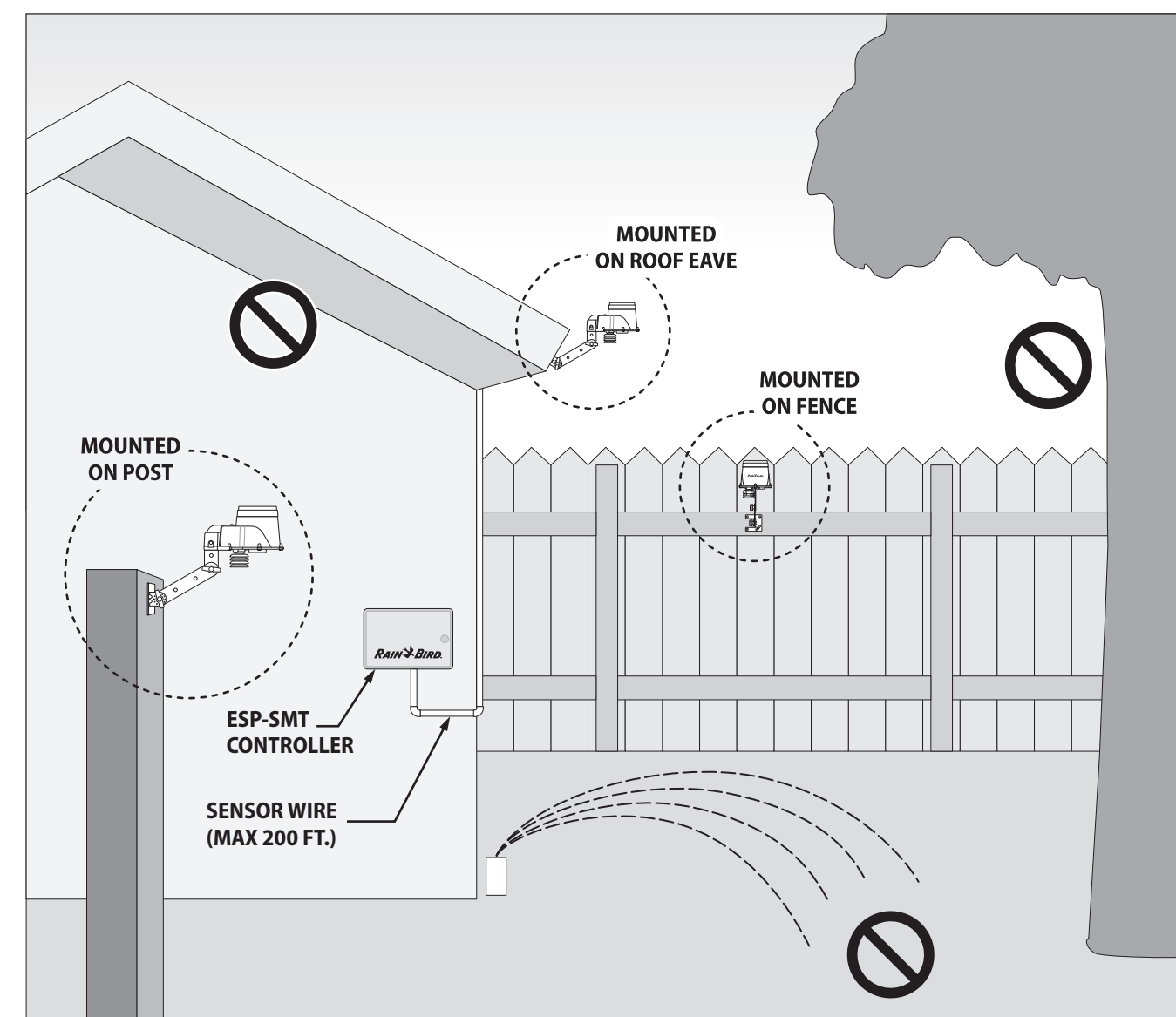

P/N: 637728-01
03/31/11

Installing The Sensor

Page 68-69 of User-manual

Mount and Wire the Sensor

- Drive a mounting screw through hole in upper left corner of mounting base into mounting surface (do not tighten yet).
- Align mounting base to approximate level position. Drive a second screw into slot in lower right corner of mounting base (do not tighten yet).
- Assure mounting base is level, then tighten the screw in slot.
- To secure base, assure that all 3 additional screws are tightened to the mounting surface.
- Unscrew the captured screw to remove the wiring compartment cover and expose the wiring terminals.
- Strip the wire insulation 3/8" and insert bare copper-leads into the tool-less connectors (polarity is not important).
- If the controller is powered, the green LED located adjacent to the terminal strip will illuminate once communication is established.
- Route the wire through the two openings in the wiring compartment cover, then tighten the captured screw to secure cover.
- Route the wires through the 3 holes located in the 2 mounting bracket arms for strain relief.
- Slide the sensor housing assembly over the top of the mounting arm and secure with the provided thumb screw.
- Adjust each of the mounting arms to assure that the sensor is secured in a level position.
- Slip the sensor debris cover onto top of sensor.

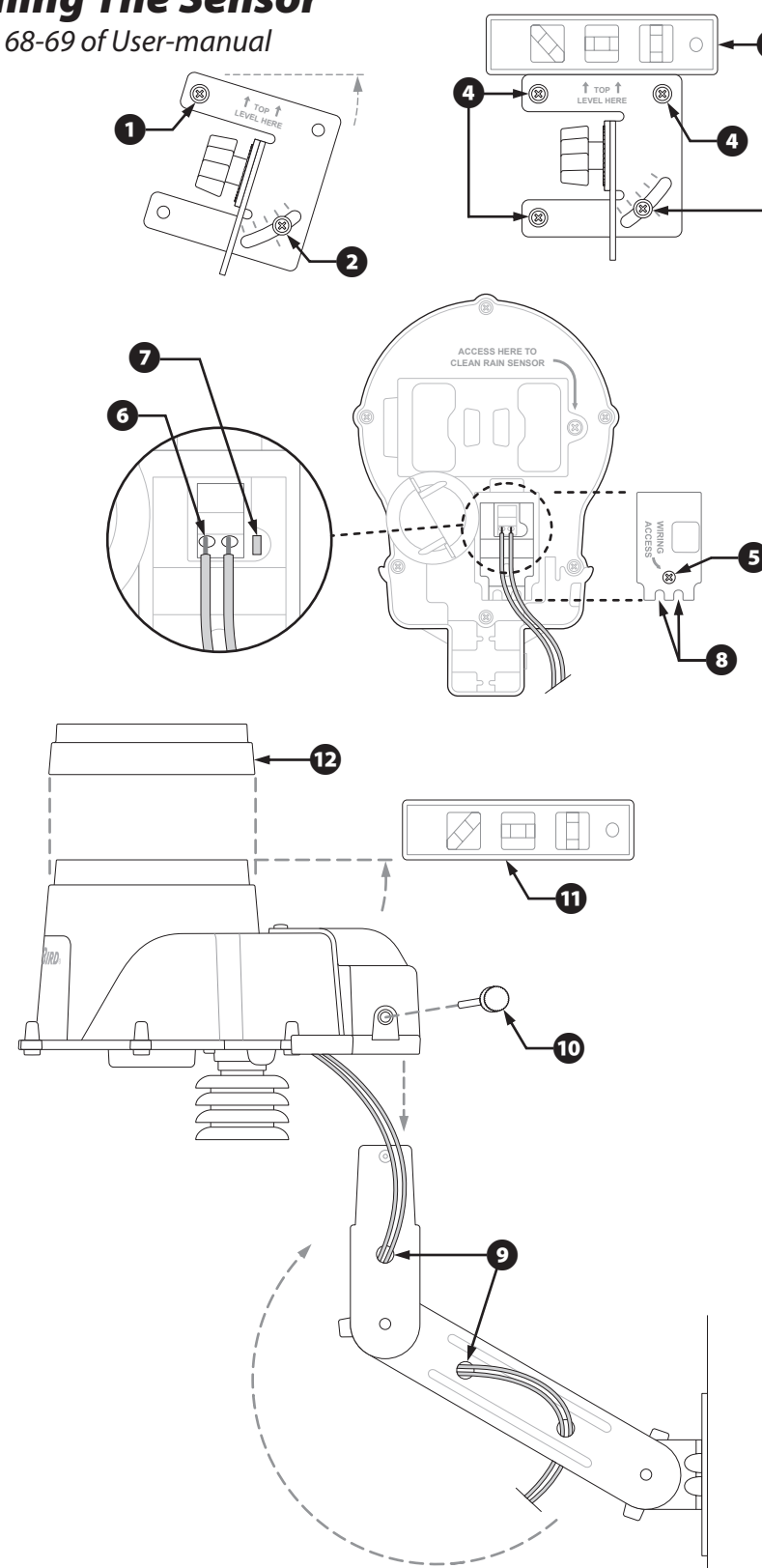

Initial Controller Setup

Controls, Switches and Indicators

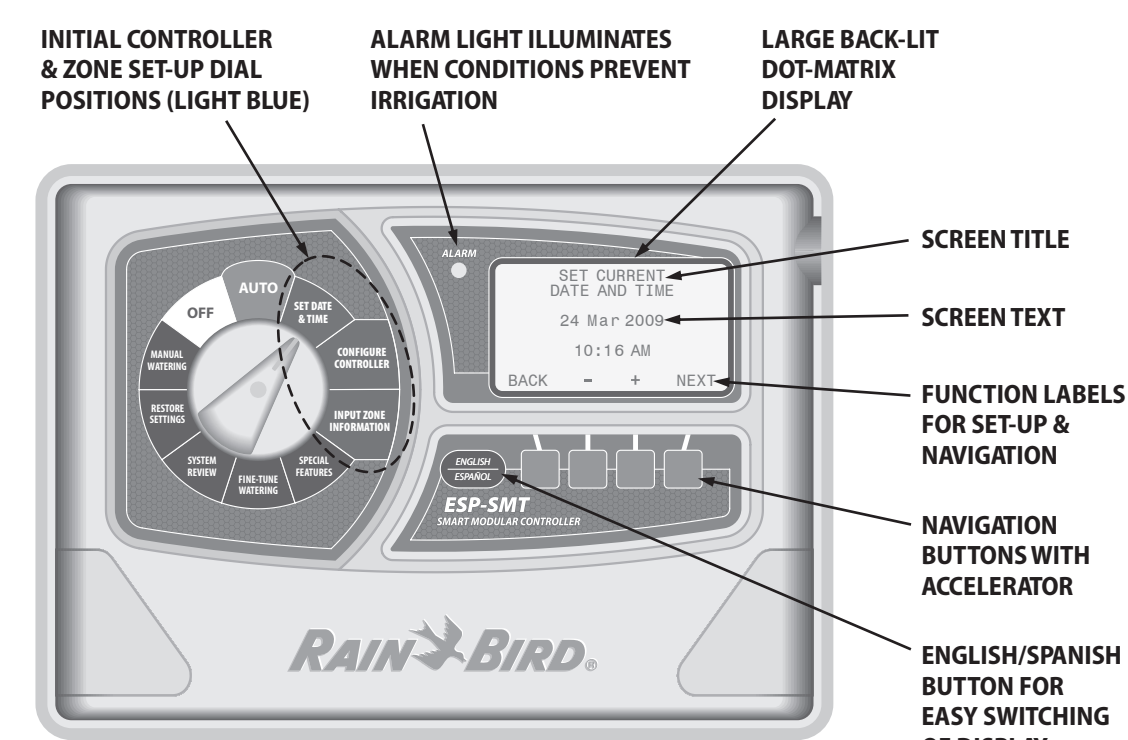

The ESP-SMT Smart Modular controller panel is designed to upgrade previously installed ESP-Modular controllers (ESP-SMT RETRO).

- Rotate dial to SET DATE & TIME position.

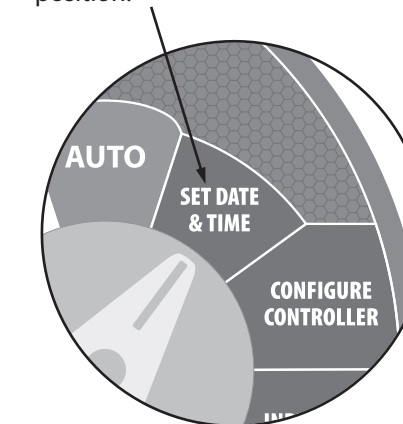

Set Date & Time

Page 7-8 of User-manual

- Set current Month.
- Set current Day of Month
- Set current Year.
- Set current Hour (assure AM or PM is correct).
- Set current Minutes.

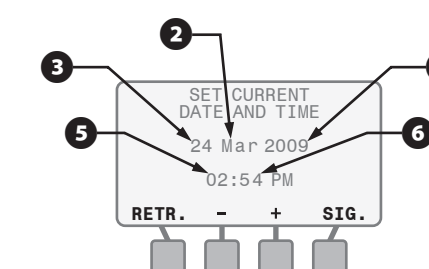

Installing The Controller

Page 56-67 of User-manual

Mount the Controller

- Remove the controller door from cabinet hinges.
- Open the face panel by grasping the crescent shaped finger hold on the top right side of the cabinet.
- Disconnect cable from back of panel.
- Remove controller panel from cabinet hinge pins.
- Drive a screw at eye level into the mounting wall surface. Leave approximately a 3/8" gap from wall.
- Slide controller keyhole slot (located on back of the cabinet) onto the screw.
- Secure controller by driving 3 screws into wall thru the holes located at bottom of controller.

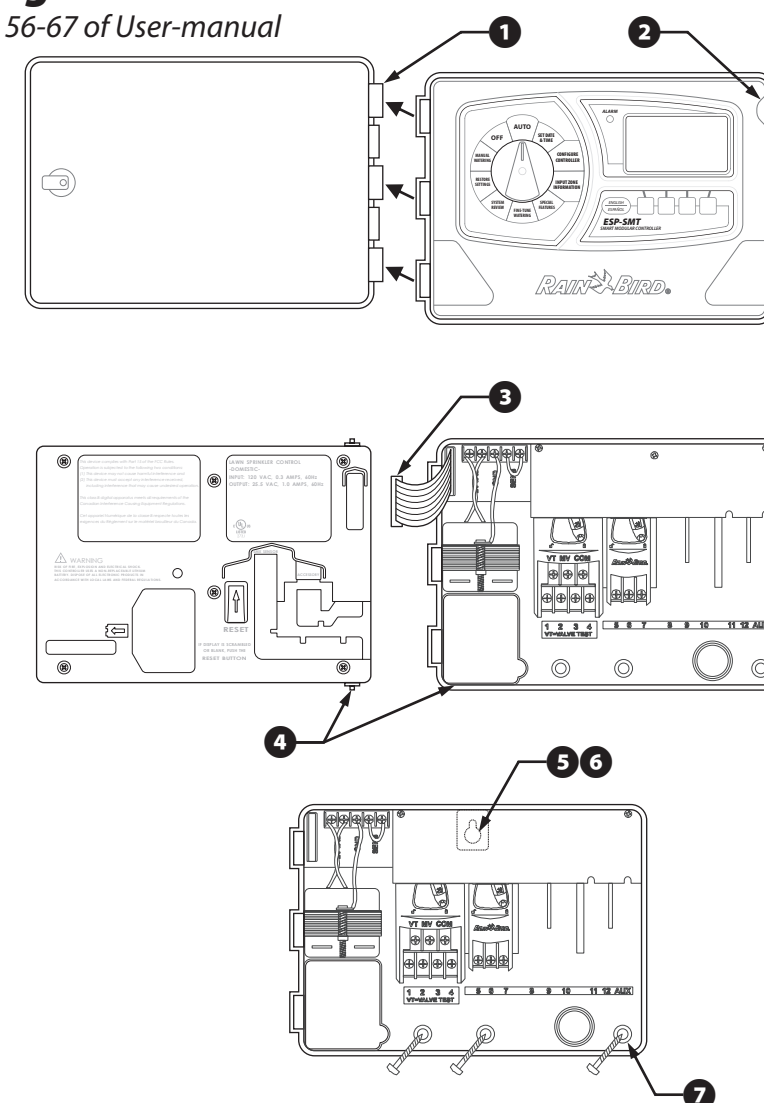

Connect Field Wiring

- Connect each valve separate power wire to the corresponding station (zone) terminal.
- Connect a common wire to one of the leads on each valve.
- Connect the other end of the common wire to the terminal location labeled COM.

NOTE: All 120V Power and Field Wiring (Valves & Pumps) is performed in the same manner as any other traditional time-based controller. For Pump, Master Valve and Control Valve Wiring Details, See User Manual - pages 61 to 62.

Connect Sensor Wire to Controller

- Run provided wire or 18-2 AWG direct burial, UV rated wire from sensor to controller (200 ft. max).
- Strip wire insulation approx 3/8" and insert leads into connector located on back of front panel (polarity not important).
- Route the two wires through the provided channel and out through one of the knockouts, located in the bottom of the controller cabinet.

Remote Programming of Controller Panel

- Insert 9-volt battery into the back of front panel to program the controller without AC power to the unit. Once completed, remove 9-volt battery from unit.

NOTE: All of the programmed information will be saved in non-volatile memory so you can pre-program the controller in advance of AC power availability.

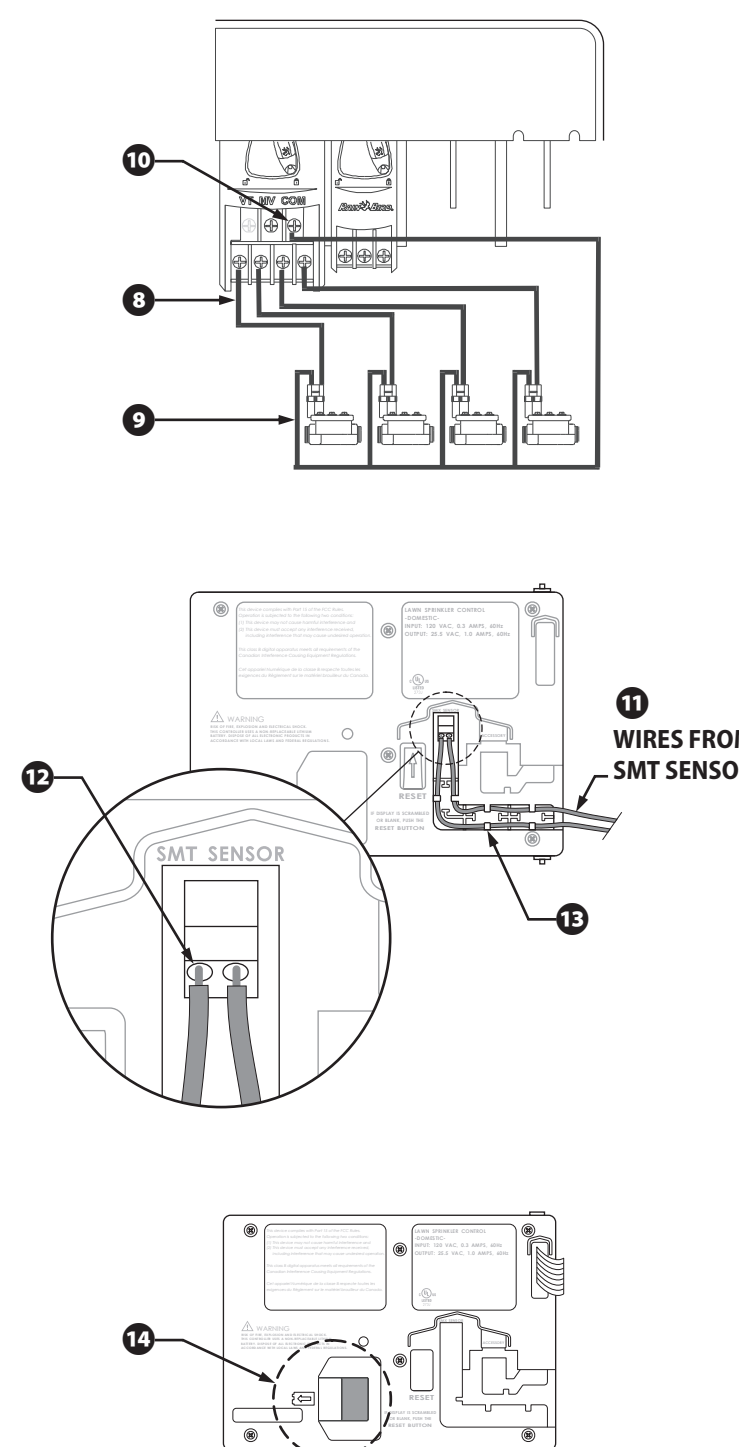

Configure Controller

Page 9-18 of User-manual

- Rotate dial to CONFIGURE CONTROLLER position.

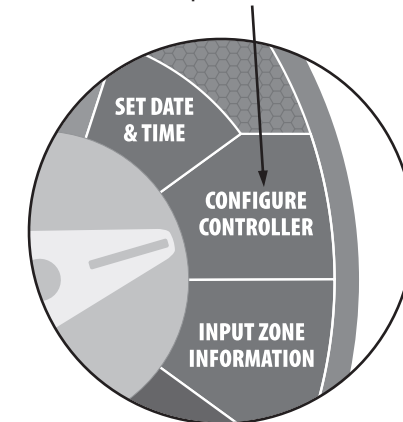

- Enter SITE ZIP CODE

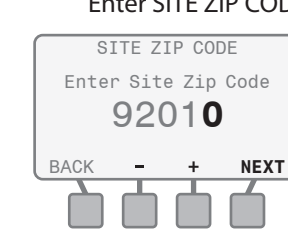

- Select ALLOWED WATER DAYS

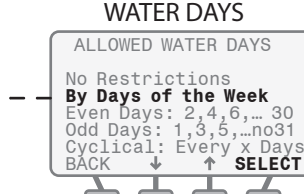

- Select BLOCK WATER DAYS (if necessary)



- Enter 1st Watering Window

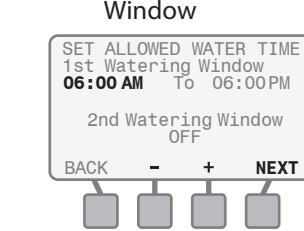

- Enter 2nd Watering Window

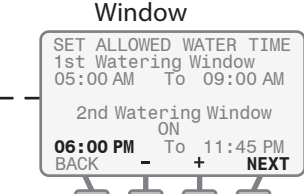

- Enter GROW-IN Watering Window

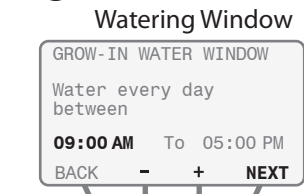

- Review Entered Info (Change or Accept)

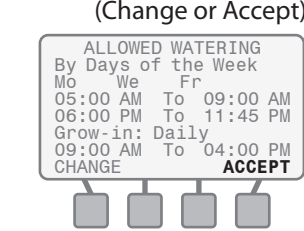

Input Zone Information

Page 19-33 of User-manual

- Rotate dial to INPUT ZONE INFORMATION position

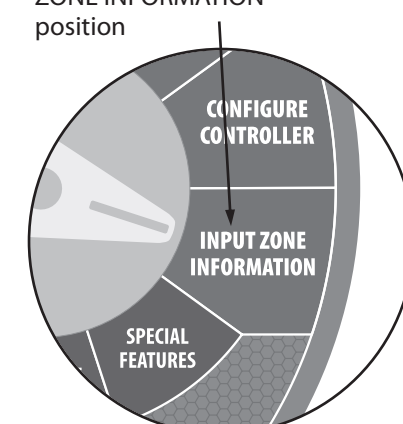

- Select SOIL TYPE

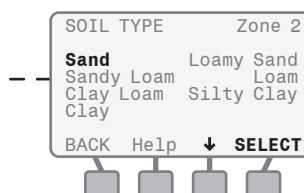

- Select SPRINKLER TYPE

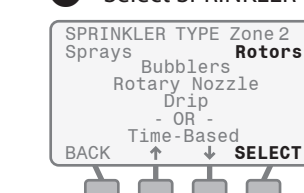

- Select DEGREE SLOPE

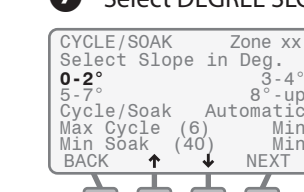

- Select PLANT TYPE

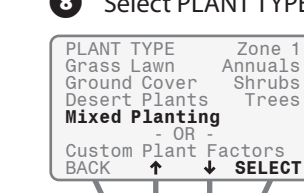

- Enter PLANT WATER NEED (non grass)

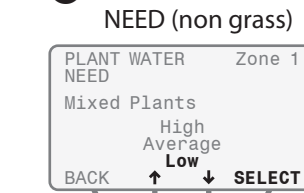

- Enter PLANT DENSITY (non grass)

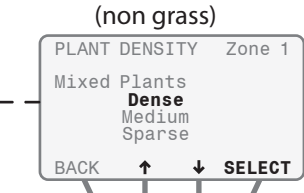

- Select SHADE FACTOR (all plants)

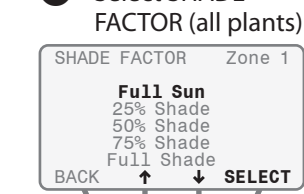

- Enter PLANT MATURITY (all plants)

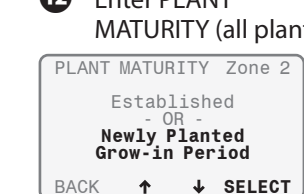

- Enter NEWLY PLANTED schedule (if needed)

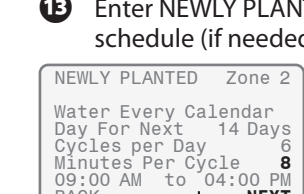

- Review Entered Info (Change or Accept)

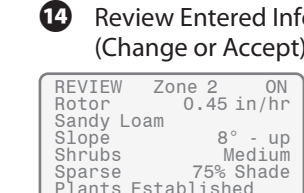

Repeat process for all desired Zones.