

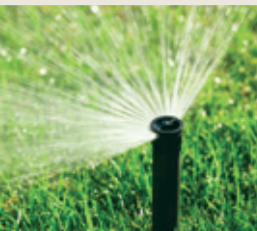

## Landscape Irrigation Products Catalog



VOLUME 1



The Intelligent Use of Water.™

**Preserving beauty while  
conserving water.**

**That's intelligent.**

## The Intelligent Use of Water™

At Rain Bird, we believe it is our responsibility to develop products and technologies that use water efficiently. Our commitment also extends to education, training and services for our industry and our communities.

Through innovative product development, Rain Bird is helping sustain healthier landscapes—and a healthier planet. A lush lawn or colorful garden can also be highly water-efficient. Every Rain Bird product is a testament to that truth.

From water-saving nozzles to sprays with pressure-regulating stems to leading-edge Smart Control Technology, Rain Bird products make the most of every drop, delivering superior results with less water. Keeping the world and your backyard beautiful. That's The Intelligent Use of Water.™

The need to conserve water has never been greater. We want to do even more, and with your help, we can.



## Water efficient Irrigation technology for every Landscape turf application

When you design and install Rain Bird complete irrigation solutions you can be confident to know that the system will perform better and last longer for many years to come. No matter what your irrigation needs are, Rain Bird has a solution that will help save water for every application in your next green project.



### Sprays Page 5

Thanks to a full range of sizes and options, with Rain Bird Spray bodies you'll have a solution for every irrigation challenge, from vandal protection to non-potable options. Rugged construction promotes years of reliable performance, while technologies like Seal-A-Matic™ (SAM) check valves and Pressure Regulating Stems (PRS) help save water.



### Spray Nozzles Page 14

Rain Bird nozzles provide more uniform coverage and eliminate over-spray which can result in substantial water savings. High Efficiency nozzles, easy, flexible adjustments and matched precipitation rates provide high distribution uniformity and wind resistant droplets.



### Rotors Page 36

Rain Bird Rotor Sprinklers set the standard for durability, and come stocked with features like; Rain curtain nozzles, optional Flow Shut-Off, Pressure Regulating Stems (PRS) with Flow Optimizer™, or Seal-A-Matic check valves. For applications with low pressure and steep slopes, in high wind areas, non-potable water or areas where vandalism could be a problem.



### Valves Page 58

Down and dirty. Hard working. Built to last. Rain Bird valves can handle the toughest jobs, under the worst conditions. In durable plastic or rugged brass, for low flows and high, even working in effluent water -- there's a Rain Bird valve for every application.



### Controllers Page 79

All Rain Bird controllers simplify conservation through a variety of water saving features. Flexible programming, Smart Controller Technologies, automatic Shut-Off devices along with many other powerful advanced features and easy to use options make the full line of Rain Bird controllers the ideal choice for Residential and Light Commercial Use.



### Central Controls Page 99

Rain Bird developed the original computer based central control system in the 1970s and today has thousands of systems installed worldwide designed to monitor and automatically adapt system operation and irrigation run-times in response to conditions in the system and surrounding area (weather change, pipe breaks, etc.) as well as parameters defined by the operator.



### Drip Irrigation Page 109

Rain Bird Landscape Drip products are made especially for low-volume irrigation systems. By delivering water at or near the plants' root zones, Rain Bird Landscape Drip products offer targeted watering with greater efficiency for healthier plants and outstanding water savings. With over 150 products, Rain Bird has the broadest drip irrigation product line in the industry to meet any site requirements.



### Pumps & Filtration Page 160

Rain Bird offers a variety of irrigation pump stations and filtration products to meet your specific application needs.



### Drainage Products Page 175

Ruggedly constructed Rain Bird grates, basins and accessories can help you efficiently manage water run-off and surface drainage for virtually any residential, commercial or municipal site.



### Resources Page 183

For information about Impacts, please visit [www.rainbird.com/impacts](http://www.rainbird.com/impacts)



## Together, we can make a difference

At Rain Bird, we believe that saving water is a responsibility that we all share. Our industry can have a tremendous impact on water conservation by installing more efficient systems and teaching customers how to use them correctly. By working together, we can really make a difference.

Rain Bird's 25 Ways offers practical, effective tips and advice drawn from the company's 80-plus years of experience in the irrigation industry. Available at [25ways.rainbird.com](http://25ways.rainbird.com), these resources can be used anywhere and by anyone who wants to improve their watering efficiency.

## Water Saving Tips from Rain Bird

Visit [25ways.rainbird.com](http://25ways.rainbird.com) for a complete list of water saving tips and techniques in each of the following categories.



Improve Your Existing System



Water Only At The Right Times



Don't Overwater



Use The Right Products

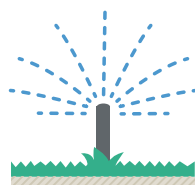

Keep Your Water In Place



Update Your Landscape

# Spray Bodies



"We've installed more than 100,000 Rain Bird 1800 Series Spray Heads because we trust their consistent quality.

We've been using Rain Bird 1800 Series Spray Heads and Nozzles exclusively for nearly 20 years. Rain Bird products serve our customers well and have helped us become one of the leading landscape companies in the Portland area."

*Rodney Reed, President  
Green Earth Landscaping, Inc.*

## Major Products

	1802, 1804, 1806	1812	1800 PRS	1800 SAM	1800 SAM-PRS	1800 SAM- PRS-45	US-400	1300/ 1400 Bubblers	PA-80 PA-85 PA-85-NP PA-85-PRS	RD-04, RD-06	RD-12	RD1800 SAM- PRS	RD1800 SAM- PRS-F	RD1800 SAM- PRS-45-F
<b>Primary Applications</b>														
Turfgrass	●		●	●	●	●	●			●		●	●	●
Slopes				●	●	●	●					●	●	●
Ground Cover/Shrubs	●	●	●	●	●	●	●	●	●	●	●	●	●	●
High Pressure Systems			●		●	●		●	●	●	●	●	●	●
Low Pressure Systems	●	●					●	●	●	●	●			
High Wind Areas	●	●	●	●	●	●	●	●	●	●	●	●	●	●
Non-Potable Water									●	●	●	●	●	●
Vandalism/Damage Prone													●	●
Dirty Water										●	●	●	●	●



## Water Saving Tips

- The patented, built-in PRS regulator maintains optimal operating pressure and restricts water loss by up to 70% if a nozzle is removed or damaged. It also ends water waste by eliminating misting and fogging caused by high pressure.
- Save water, stop low head drainage, and reduce water hammer by preventing water from draining out of pipes after irrigation with 1800/RD1800 Series Sprays featuring Seal-A-Matic™ (SAM) check valves.
- Exclusive Flow Shield Technology available in the RD1800 Series provides up to 90% reduction in water loss when a nozzle is removed, preventing potentially costly and unacceptable run-off.

### UNI-Spray™ Series

Compact and reliable spray heads for any application

#### Features

- Small exposed cover makes the unit virtually invisible for more attractive landscapes
- Constructed of durable materials including corrosion resistant stainless steel, assuring long product life even in high pressure or surge conditions
- Pressure-activated wiper seal prevents excessive flow-by and water waste and keeps debris from entering upon retraction
- Two-piece ratchet mechanism allows easy nozzle pattern alignment and provides added durability
- Three Year Trade Warranty

#### Operating Range (for pre-installed nozzle choices)

- Spacing:
  - 8' HE-VAN Series: 6 to 8 feet (1.8 to 2.4m)
  - 10' HE-VAN Series: 8 to 10 feet (2.4 to 3.0m)
  - 12' HE-VAN Series: 9 to 12 feet (2.7 to 3.7m)
  - 15' HE-VAN Series: 12 to 15 feet (3.7 to 4.6m)
- Pressure: 15 to 70 psi (1.0 to 4.8 bar)
- Optimum pressure: 30 psi (2.1 bar)
- Adjustable nozzle arc range: 0° - 360°

#### Specifications

- Flow-by: 0 at 10 psi (0.75 bar) or greater; 0.20 gpm (0.04 m<sup>3</sup>/h; 0.60 l/m) otherwise

#### Models\*

- US400: 4" pop-up height (10.2cm)

#### Models with High-Efficiency Nozzles Pre-Attached\*

- US408HE: 4" pop-up height (10.2cm) with HE-VAN-08 attached
- US410HE: 4" pop-up height (10.2cm) with HE-VAN-10 attached
- US412HE: 4" pop-up height (10.2cm) with HE-VAN-12 attached
- US415HE: 4" pop-up height (10.2cm) with HE-VAN-15 attached

\*The UNI-Spray accepts all Rain Bird nozzles



High Efficiency Variable Arc Nozzles (8, 10, 12, or 15 feet) are available pre-installed

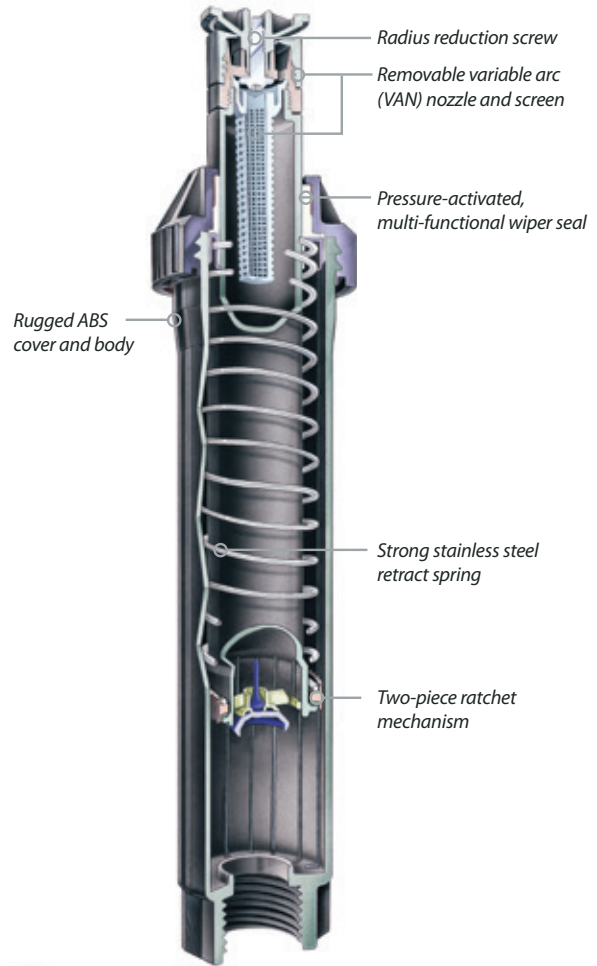

UNI-Spray™

#### How To Specify

**US - 4 - 10HE**

Model: US-Spray

Body: 4" (10.2 cm)

Nozzle Series/Pattern: HE-VAN nozzle

## 1800® Series

The #1 irrigation spray head in the world

### Features

- Co-molded wiper seal provides unmatched resistance to grit, pressure and the environment
- Constructed of time-proven UV-resistant plastic and corrosion resistant stainless steel parts, ensuring long product life
- Precision controlled flush at pop-down clears debris from unit, assuring positive stem retraction in all soil types
- Two-piece ratchet mechanism allows easy nozzle pattern alignment and provides added durability
- Five Year Trade Warranty

### Operating Range

- Spacing: 2.5 to 24 feet (0.8 to 7.3m)\*\*
- Pressure: 15 to 70 psi (1.0 to 4.8 bar)

### Specifications

- Flow-by: 0 gpm at 8 psi (0.6 bar) or greater;  
0.10 gpm (0.02 m<sup>3</sup>/h; 0.36 l/m) otherwise

### Dimensions/Models

- ½" (15/21) NPT female threaded inlet
- Models and height:
  - 1802: 4" (10.2 cm) body height; 2" pop-up height (5.1 cm)
  - 1804: 6" (15.2 cm) body height; 4" pop-up height (10.2 cm)
  - 1806: 9 ¾" (23.8 cm) body height; 6" pop-up height (15.2 cm)
  - 1812: 16" (40.6 cm) body height; 12" pop-up height (30.5 cm)
- Exposed surface diameter: 2 ¼" (5.7 cm)

\* 1806 and 1812-SAM, SAMPRS, and SAM-PRS-45 units do not have a side inlet

\*\* 2.5 to 15 feet with standard Rain Bird Spray Head Nozzles (SQ, U-Series, HE-VAN) 8 to 24 feet with Rain Bird Rotary Nozzles

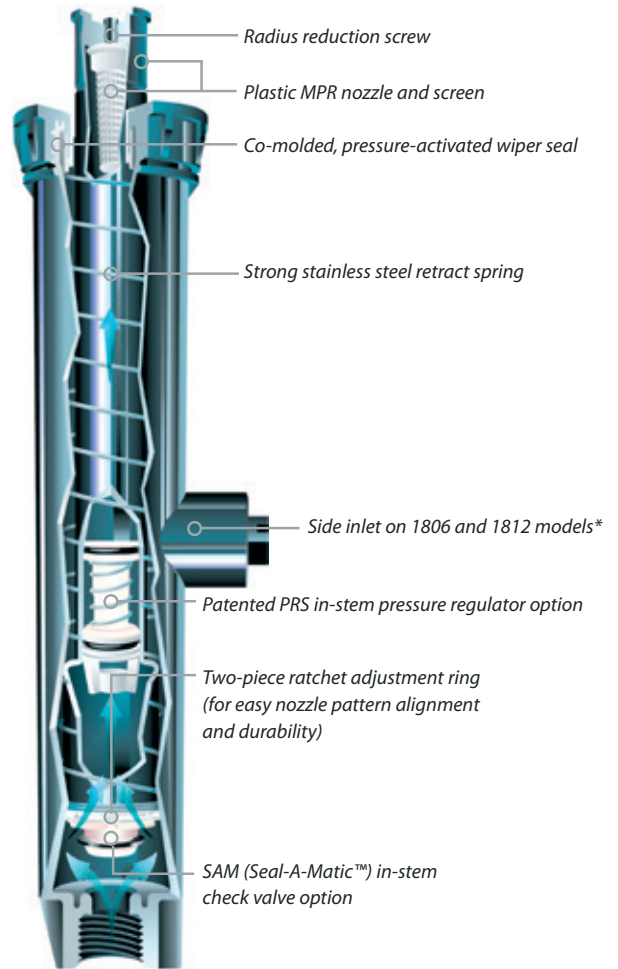

Spray Bodies



### How To Specify

#### 1804 SAM-PRS

Option  
SAM: Seal-A-Matic™ check valve  
PRS: Pressure regulator

#### Pop-up Height

1802: 2" pop-up height (5.1 cm)  
1804: 4" pop-up height (10.2 cm)  
1806: 6" pop-up height (15.2 cm)  
1812: 12" pop-up height (30.5 cm)

#### Model

1800 Series Spray Bodies

### 1800®-SAM, 1800®-PRS, 1800®-SAM-PRS, 1800®-SAM-P45 Series

4", 6", 12" (10.2 cm, 15.2 cm, 30.5 cm)

Spray Bodies

#### Features

- **1800®-SAM Series:** Built-in Seal-A-Matic™ (SAM) check valve. Eliminates the need for under-the-head check valves. Traps water in lateral pipes in elevation changes of up to 14 feet (4.2 m). Reduces wear on system components by minimizing water hammer during start-up
- **1800®-PRS Series:** Maintains constant outlet pressure at 30 psi (2.1 bar). PRS pressure regulator built into the stem simplifies system design. Eliminates misting and fogging caused by high pressure. Saves time and money
- **1800®-SAM-PRS Series:** Incorporates all 1800 Series SAM and PRS features. Meets the needs of all spray areas, regardless of changing elevation or water pressures
- **1800®-SAM-P45 Series:** Maintains constant outlet pressure at 45 psi (3.1 bar) at varying inlet pressures. Ensures maximum spray body and nozzle performance, even with varying inlet pressures. Maintains constant pressure regardless of nozzle used

#### Specifications

- SAM capability: holds up to 14 feet (4.2 m) of head; 6 psi (0.4 bar)
- PRS models regulate nozzle pressure to an average 30 or 45 psi (2.1 or 3.1 bar) with inlet pressures of up to 70 psi (4.8 bar)
- Flow-by: 0 gpm at 8 psi (0.6 bar) or greater; 0.10 gpm (0.02 m³/h; 0.36 l/m) otherwise
- Installation: side or bottom inlet
- Side inlet installation not recommended in freezing climates
- Five Year Trade Warranty

#### 1800-SAM Models

- 1804-SAM: 4" pop-up height (10.2 cm)
- 1806-SAM: 6" pop-up height (15.2 cm)
- 1812-SAM: 12" pop-up height (30.5 cm)

#### 1800-PRS Models

- 1804 PRS: 4" pop-up height (10.2 cm)
- 1806 PRS: 6" pop-up height (15.2 cm)
- 1812 PRS: 12" pop-up height (30.5 cm)

#### 1800-SAM-PRS Models

- 1804-SAM-PRS: 4" pop-up height (10.2 cm)
- 1806-SAM-PRS: 6" pop-up height (15.2 cm)
- 1812-SAM-PRS: 12" pop-up height (30.5 cm)

#### 1800-SAM-P45 Models

- 1804-SAM-P45: 4" pop-up height (10.2 cm)
- 1806-SAM-P45: 6" pop-up height (15.2 cm)
- 1812-SAM-P45: 12" pop-up height (30.5 cm)

#### Operating Range

- Spacing: 2.5 to 24 feet (0.8 to 7.3m)\*
- Pressure: 15 to 70 psi (1.0 to 4.8 bar)



1800-SAM



1800-PRS



1800-SAM-PRS



1800-SAM-P45

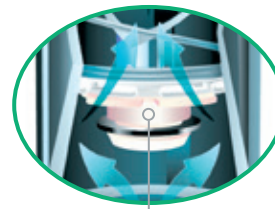

Built in Seal-A-Matic check valve prevents low-head drainage, ideal for use in changing elevations

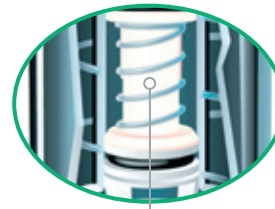

Patented pressure regulator in stem compensates for high or fluctuating water pressure to ensure maximum performance

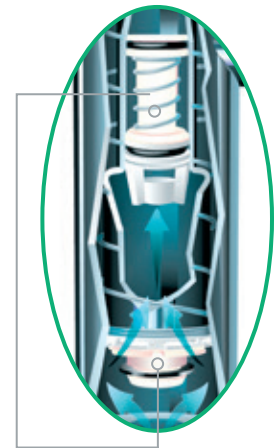

Top-of-the-line spray head includes all the features of the SAM and PRS series, ideal regardless of pressure or elevation

\* 2.5 to 18 feet with standard Rain Bird Spray Head Nozzles (SQ, MPR, VAN, U-Series), 13 to 24 feet with Rain Bird Rotary Nozzles



## RD1800™ Series Spray Heads

4", 6", 12" (10.2 cm; 15.2 cm; 30.5 cm)

### Features

- Patented, Triple-Blade Wiper Seal precisely balances flushing, flow-by and debris protection to optimize performance and durability at pop-up and retraction. Precision-controlled flushing at pop-up and retraction clears debris, ensuring positive stem retraction in all soil types
- Unique debris pockets hold grit in place, removing it from circulation and preventing long-term damage. Parts resistant to corrosion in treated recycled water containing chlorine
- **RD1800™ SAM PRS Series:** Incorporates all RD1800 Series SAM and PRS features. Meets the needs of all spray areas, regardless of changing elevation or water pressures
- **RD1800™ Flow-Shield™ Series:** Provides low flow vertical water jet visible from +200' line of sight when a nozzle has been removed
- **RD1800™ Non-Potable Water Series:** Provides an alternative to clip-on caps and molded purple covers. Easy-to-read English "DO NOT DRINK", Spanish "NO BEBA" warnings, and international do not drink symbol

### Operating Range

- Spacing: 2.5 to 24 feet (0.8 to 7.3 m)
- Pressure: 15 to 100 psi (1.0 to 6.9 bar)

### Specifications

- SAM capability: Holds up to 14 feet (4.2 m) of head; 6 psi (0.3 bar)
- Flow-by: SAM Models: 0 at 15 psi (1.0 bar) or greater; 0.5 gpm (0.1 m<sup>3</sup>/h; 0.03 l/s) otherwise  
All Other Models: 0 at 10 psi (0.7 bar) or greater; 0.5 gpm (0.1 m<sup>3</sup>/h; 0.03 l/s) otherwise
- SAM-PRS models regulate nozzle pressure to an average 30 or 45 psi (2.1 or 3.1 bar) with inlet pressures of up to 100 psi (6.9 bar)
- Side inlets featured on non Seal-A-Matic™ (SAM) models only
- Five-year trade warranty

### Dimensions

- ½" (15/21) NPT female threaded inlet

Models	4"	6"	12"
RD04	–	–	–
RD04-NP	–	–	–
RD04-S-P-30	–	RD06-S-P-30	RD12-S-P-30
RD04-S-P-30-NP	–	RD06-S-P-30-NP	RD12-S-P-30-NP
RD04-S-P-30-F	–	RD06-S-P30-F	RD12-S-P-30-F
RD04-S-P-30-F-NP	–	RD06-S-P-30-F-NP	RD12-S-P-30-F-NP
RD04-S-P-45-NP	–	RD06-S-P-45-NP	RD12-S-P-45-NP
RD04-S-P-45-F	–	RD06-S-P-45-F	RD12-S-P-45-F
RD04-S-P-45-F-NP	–	RD06-S-P-45-F-NP	RD12-S-P-45-F-NP

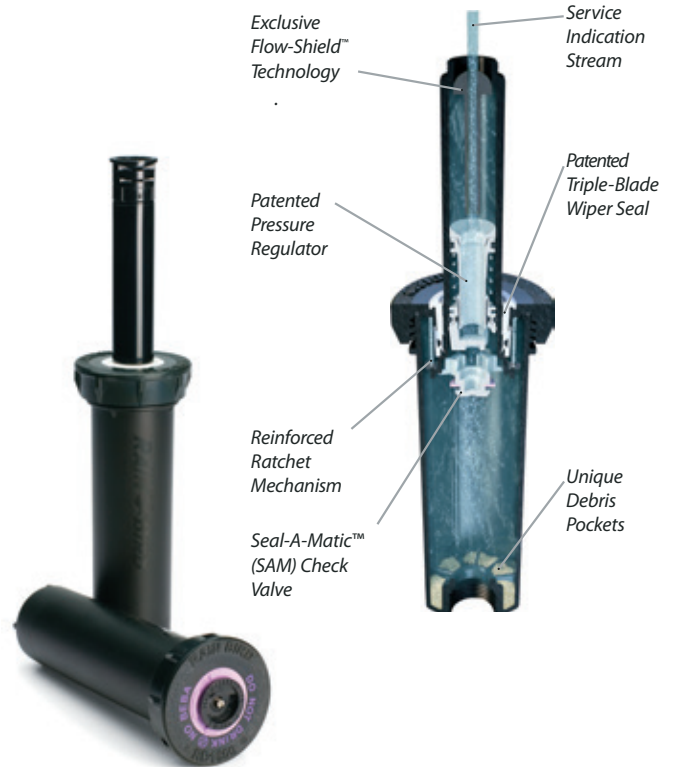

RD1800 Series



Standard Cover



Non-Potable Cover

### How To Specify

#### RD-XX - X - Nozzle

**Nozzle**  
See Rotary Nozzle, U-Series, MPR, VAN, HE-VAN and SQ Nozzle specifications for more information

#### Optional Features

- S: Seal-A-Matic™ check valve
- P30: 30 psi (2.1 bar) in-stem pressure regulation
- P45: 45 psi (3.1 bar) in-stem pressure regulation
- F: Flow-Shield™ Technology
- NP: Non-potable water use indicating cover

#### Model

- RD-04: 4" (10 cm) pop-up height
- RD-06: 6" (15 cm) pop-up height
- RD-12: 12" (40 cm) pop-up height

#### Notes:

Flow-Shield™ Technology available in P30 and P45 models only.  
Specify sprinkler bodies and nozzles separately.

### 1800® NP Cover

Non-Potable 1800 Spray Head Cover

#### Features

- Designed for excellent retention on 1800 Series Spray Body covers
- Purple plastic cover for easy identification of non-potable water system
- Marked with "Do Not Drink!" warning in both English and Spanish
- Snaps onto all 1800® Series Spray Body covers

#### Model

- 1800-NPCAP



1800-NPCAP

### PA

Plastic Shrub Adapter

#### Features

- Adapts Rain Bird Nozzles for use with 1/2" (15/21) NPT threaded risers
- Accepts protective, non-clogging 1800 Series filter screen (shipped with nozzle) and PCS Series screens
- Durable, non-corrosive plastic construction
- Non-Potable Plastic Shrub Adapter

#### Specifications

- 1/2" (15/21) female inlet threads
- Fine top threads accept all Rain Bird nozzles

#### Model

- PA-8S
- PA-8S-NP



PA-8S



PA-8S-NP

### PA-80

Plastic Adapter

#### Features

- Adapts Rain Bird Spray Bodies for use with any 1/2" (15/21) FPT bubbler or spray nozzle
- Rugged, UV-resistant thermoplastic construction
- Easy to install; no tools required

#### Dimensions

- Height: 1 1/2" (3.8 cm); 0.8" (2.0 cm) above 1800 cap

#### Model

- PA-80



PA-80

### 1800®-EXT

Plastic Extension

#### Features

- UV-resistant thermoplastic construction for long life
- Fits all Rain Bird Spray Bodies and Nozzles. Exception: Cannot be used with bubblers

#### Model

- 1800-EXT



1800-EXT

### PA-8S-PRS

Pressure Regulating Shrub Adapter

#### Features

- Adapts nozzles for use with 1/2" (15/21) NPT threaded risers
- Patented PRS pressure regulator built into the stem. No parts to be installed at the site. Saves time and money
  - Maintains constant outlet pressure at 30 psi (2.1 bar). Ensures maximum spray head and nozzle performance
  - Restricts water loss by up to 70% if nozzle is removed or damaged. Saves water and money. Reduces liability. Recommended for vandal-prone areas
- Fits all Rain Bird plastic nozzles
- Rugged thermoplastic construction resists UV rays

#### Operating Range

- Pressure: 15 to 70 psi (1.0 to 4.8 bar)
- Flow: 0.2 to 4.0 gpm (0.05 to 0.91 m<sup>3</sup>/h; 0.06 to 15.0 l/m)

#### Specifications

- 1/2" (15/21) female inlet threads
- Fine top threads accept all Rain Bird nozzles
- Height: 5 1/4" (13.3 cm)

#### Model

- PA-8S-PRS



PA-8S-PRS

### 1800 PCS

Pressure Compensating Screens

#### Features

- Compensates\* for pressure variations
- Eliminates fogging and water waste caused by high pressures
- Nozzles can be matched with screens to create short-throw, reduced-radius patterns and/or flush-mounted bubblers
- Color-coded for easy identification
- Use with all 1800 Series plastic nozzles (MPR, VAN, U-Series, Strips and Bubblers)

#### Operating Range

- Flow: 0.20 to 0.90 gpm (0.05 to 0.20 m<sup>3</sup>/h; 0.6 to 3.6 l/m)
- Pressure: 15 to 70 psi (1.0 to 4.8 bar)

#### Models

- PCS-020: 0.2 gpm (0.05 m<sup>3</sup>/h; 0.6 l/m) - Brown
- PCS-025: 0.25 gpm (0.06 m<sup>3</sup>/h; 1.2 l/m) - Pink
- PCS-030: 0.3 gpm (0.07 m<sup>3</sup>/h; 1.2 l/m) - Silver
- PCS-040: 0.4 gpm (0.09 m<sup>3</sup>/h; 1.8 l/m) - Orange
- PCS-060: 0.6 gpm (0.14 m<sup>3</sup>/h; 2.4 l/m) - Black
- PCS-090: 0.9 gpm (0.20 m<sup>3</sup>/h; 3.6 l/m) - White

\* With a pressure compensator, outlet pressure will be reduced, but will fluctuate as the inlet pressure changes. A pressure compensator cannot maintain outlet pressure at a constant rate. A pressure regulator establishes and maintains a constant outlet pressure of 30 psi (2.1 bar) as long as the inlet pressure at the spray head is greater than 30 psi (2.1 bar)



1800 PCS  
Screens

1800 PCS Performance

Flow (gpm) m <sup>3</sup> /h (l/m)	PCS-020 (Brown) 0.2 0.05 (60)		PCS-025 (Pink) 0.25 0.06 (72)		PCS-030 (Silver) 0.3 0.07 (84)		PCS-040 (Orange) 0.4 0.09 (108)		PCS-060 (Black) 0.6 0.14 (144)		PCS-090 (White) 0.9 0.20 (216)		
	Distance	feet	meters	feet	meters	feet	meters	feet	meters	feet	meters	feet	meters
<b>U-Series</b>													
U-8Q		6	(1.8)	7	(2.1)								
U-8H		4	(1.2)	5	(1.5)								
U-8F						1	(0.3)	3	(0.9)	7	(2.1)		
U-10Q		5	(1.5)	6	(1.8)	10'	(3.1)						
U-10H						5	(1.5)	6	(1.8)	8	(2.4)	9	(2.7)
U-10F										4	(1.2)	9	(2.7)
U-12Q		2'	(0.6)	4	(1.2)	7'	(2.1)	12'	(3.7)				
U-12H						3'	(0.9)	4'	(1.2)	7'	(2.1)	11'	(3.4)
U-12F								3'	(0.9)	6'	(1.8)	8'	(2.4)
U-15Q				3'	(0.9)	6'	(1.8)	11'	(3.4)	15'	(4.6)		
U-15H						2'	(0.6)	3'	(0.9)	5'	(1.5)	9'	(2.7)
U-15F										4'	(1.2)	6'	(1.8)
<b>VAN</b>													
4 (90°)		1'	(0.3)			3'	(0.9)	4'	(1.2)				
4 (180°)				1'	(0.3)	2'	(0.6)	3'	(0.9)	4'	(1.2)		
4 (270°)						1'	(0.3)	2'	(0.6)	4'	(1.2)		
4 (330°)						1'	(0.3)	2'	(0.6)	4'	(1.2)		
6 (90°)				2'	(0.6)	3'	(0.9)	6'	(1.8)				
6 (180°)						2'	(0.6)	4'	(1.2)	6'	(1.8)		
6 (270°)						0.5'	(0.2)	1'	(0.3)	3'	(0.9)	6'	(1.8)
6 (330°)						0.5'	(0.2)	1'	(0.3)	3'	(0.9)	6'	(1.8)
8 (90°)						1'	(0.3)	3'	(0.9)	8'	(2.4)		
8 (180°)						0.5'	(0.2)	2'	(0.6)	4'	(1.2)	8'	(2.4)
8 (270°)								0.5'	(0.2)	3'	(0.9)	5'	(1.5)
8 (330°)								0.5'	(0.2)	3'	(0.9)	5'	(1.5)
10 (90°)						3'	(0.9)	5'	(1.5)	10'	(3.1)		
10 (180°)								1'	(0.3)	5'	(1.5)	7'	(2.1)
10 (270°)								1'	(0.3)	4'	(1.2)	6'	(1.8)
10 (360°)						0.5'	(0.2)	1'	(0.3)	4'	(1.2)	6'	(1.8)
12 (90°)		3'	(0.9)			8'	(2.4)	10'	(3.1)	12'	(3.7)		
12 (180°)						1'	(0.3)	2'	(0.6)	5'	(1.5)	8'	(2.4)
12 (270°)						0.5'	(0.2)	1'	(0.3)	3'	(0.9)	6'	(1.8)
12 (360°)								1'	(0.3)	3'	(0.9)	5'	(1.5)
15 (90°)						2'	(0.6)	5'	(1.5)	11'	(3.4)	15'	(4.6)
15 (180°)						1'	(0.3)	3'	(0.9)	6'	(1.8)	9'	(2.7)
15 (270°)												6'	(1.8)
15 (360°)													
18 (90°)						0.5'	(0.2)	2'	(0.6)	6'	(1.8)	12'	(3.7)
18 (180°)								1'	(0.3)	3'	(0.9)	5'	(1.5)
18 (270°)								0.5'	(0.2)	1'	(0.3)	3'	(0.9)
18 (330°)								0.5'	(0.2)	1'	(0.3)	3'	(0.9)
<b>MPR</b>													
5Q													
5T													
5H		5'	(1.5)	6'	(1.8)								
5F						5'	(1.5)						
8Q		8'	(2.4)	10'	(3.1)								
8T		6'	(1.8)	6.5'	(2.0)	7'	(2.1)	8'	(2.4)				
8H		5'	(1.5)	6'	(1.8)	7'	(2.1)	8'	(2.4)				
8F						2'	(0.6)	3'	(0.9)	8'	(2.4)		
10Q		6'	(1.8)	8'	(2.4)	8'	(2.4)	10'	(3.1)				
10T		4'	(1.2)	5'	(1.5)	9'	(2.7)	10'	(3.1)				
10H		3'	(0.9)	4'	(1.2)	6'	(1.8)	8'	(2.4)	10'	(3.1)		
10F								1'	(0.3)	4'	(1.2)	8'	(2.4)
12Q		3'	(0.9)	7'	(2.1)	8'	(2.4)	11'	(3.4)	12'	(3.7)		
12T		2'	(0.6)	4'	(1.2)	6'	(1.8)	10'	(3.1)	11'	(3.4)	12'	(3.7)
12H						4'	(1.2)	6'	(1.8)	10'	(3.1)	12'	(3.7)
12TT						2'	(0.6)	4'	(1.2)	6'	(1.8)	9'	(2.7)
12TQ						2'	(0.6)	3'	(0.9)	6'	(1.8)	8'	(2.4)
12F								2'	(0.6)	5'	(1.5)	7'	(2.1)
15Q		3'	(0.9)	4'	(1.2)	5'	(1.5)	9'	(2.7)	12'	(3.7)	15'	(4.6)
15T				2'	(0.6)	5'	(1.5)	7'	(2.1)	12'	(3.7)	14'	(4.3)
15H						3'	(0.9)	4'	(1.2)	7'	(2.1)	11'	(3.4)
15TT						1'	(0.3)	2'	(0.6)	4'	(1.2)	8'	(2.4)
15TQ												6'	(1.8)
15F												4'	(1.2)
<b>Bubbler</b>													
5Q-B		2'	(0.6)	3	(0.9)	4'	(1.2)	5'	(1.5)				
5H-B						1'	(0.3)	2'	(0.6)	5'	(1.5)		
5F-B								1'	(0.3)	2'	(0.6)	3'	(0.9)
5CST-B		1'	(0.3)	2	(0.6)	3'	(0.9)	5'	(1.5)				
<b>Strip</b>													
9SST												7' x 12'	(2.1 x 3.7)
15CST								4' x 12'	(1.2 x 3.7)	4' x 24'	(1.2 x 7.3)	4' x 30'	(1.2 x 9.1)
15SST								2' x 10'	(0.6 x 3.1)	3' x 20'	(0.9 x 6.1)	4' x 26'	(1.2 x 7.9)
15EST						3' x 12'	(0.9 x 3.7)	4' x 15'	(1.2 x 4.6)				
15LCS		1' x 5'	(0.3 x 1.5)	1' x 7'	(0.3 x 2.1)	1' x 12'	(0.3 x 3.7)						
15RCS		1' x 5'	(0.3 x 1.5)	1' x 7'	(0.3 x 2.1)	1' x 12'	(0.3 x 3.7)						

**Bold green type indicates recommended nozzle/screen combination to achieve catalog performance at 30 psi (2.1 bar)**

**Bold blue type indicates satisfactory nozzle/screen combination**

Black type indicates a nozzle/screen combination that provides a throw reduction of more than 50%. With these nozzle/screen combinations a uniform spray pattern is not assured and a bubbler effect may result.

**Note:** Screens were tested at 50 psi (3.5 bar) for 10 minutes prior to taking distance measurements. Distances may vary slightly with higher pressures and longer run-times  
**Note:** Refer to catalog notation for proper nozzle selection

### SA Series

Swing Assemblies Connect Heads to Lateral Pipes.

#### Features

- Quality alternative to locally assembled swing pipe/spiral barb fittings that do not carry a manufacturer's warranty
- Comprehensive range of products support a variety of landscape solutions
- Complementary engineered fittings and spray heads instill confidence in product specification

#### Specifications

- The operating range of the Rain Bird Swing Assemblies matches or exceeds the operating range for most ½" (1.3 cm) sprays and ¾" (1.9 cm) rotors
- Operating pressure: Up to 80 psi (5.5 bar)
- Surge pressure: Up to 240 psi (15.5 bar)
- Temperature: Up to 110° F (43° C)
- Maximum flow: 8 gpm (0.5 l/sec)



Swing Pipe Flexible  
Sprinkler Assembly



SA Series

#### How To Specify

##### SA 12 5050

Inlet/Outlet  
050: ½" x ½"  
5050: ½" x ½"  
5075: ½" x ¾"  
7575: ¾" x ¾"

Length  
18"  
12"  
6"

Model  
Swing Assembly

#### SA Series Swing Assemblies Specifications

Model Number	Part Number	Length		Inlet		Outlet	
		US	METRIC	US	METRIC	US	METRIC
SA-6050	A48030	6"	15.2 cm	½"	1.3 cm	½"	1.3 cm
SA-125050	A48035	12"	30.5 cm	½"	1.3 cm	½"	1.3 cm
SA-127575	A48050	12"	30.5 cm	¾"	1.9 cm	¾"	1.9 cm
SA-185050	A48065	18"	45.7 cm	½"	1.3 cm	½"	1.3 cm

## SPX Series Swing Pipe

Swing Pipe with Spiral Barb Fittings Provides a Flexible Swing Assembly for Sprays and Rotors

### Features and Benefits

- **SPX-FLEX100**
  - Superior flexibility allows pipe to be efficiently routed around hardscape, terraces, and uneven terrain to turn landscape design into reality
  - Textured surface makes product easier to handle, contributing to labor efficiency, especially under wet conditions
  - Resists kinking
  - Quick and easy installation lowers material and labor costs
  - Installs quickly leaving time for additional system installations and incremental revenue opportunities

### Specifications

- Inside diameter: 0.49" (1.24 cm)
- Operating pressure: Up to 80 psi (5.5 bar)
- Temperature: Up to 110° F (43° C)

### Models

- SPX-FLEX-100: 100' (30 m) coil

## SPX-FLEX

Extra Flexible Kink-Resistant Swing Pipe



- Same High Quality
- NOW 25% More Flexible



SPX-FLEX100

## SB Series Spiral Barb Fittings

A Natural Product Complement to SPX Series Swing Pipe

### Features and Benefits

- Fittings are made of robust acetal material to make connecting swing pipe fast and easy
- Easy twist-in insertion – no glue or clamps needed for installation
- Aggressive barb lip makes a secure connection that is less likely to leak

- Broad range of shapes and sizes allow the contractor to choose the best fitting for the application
- Extended length and aggressive barb lip prevent blow outs, reducing likelihood of contractor call backs

### Specifications

- Operating pressure: Up to 80 psi (5.5 bar)
- Temperature: Up to 110° F (43° C)

### Models

- SB-CPLG: 1/2" barb x 1/2" barb coupling
- SBA-050: 1/2" M NPT x 1/2" barb adapter
- SBE-075: 3/4" M NPT x 1/2" barb elbow
- SBE-050: 1/2" M NPT x 1/2" barb elbow
- SB-TEE: 1/2" barb x 1/2" barb x 1/2" barb tee



# Spray and Rotary Nozzles

Introduction

Spray/Bodies

Spray Nozzles

Rotors

Valves

Controllers

Central Controls

Landscape Drip

Pumps & Filtration

Drainage Products

Resources



*"The beauty of the HE-VAN is that with one simple change we got a lot of benefits, like saving money, water, and time. We also anticipate decreased liability and reduced system wear and tear. Now we can confidently meet industry regulations and environmental challenges while providing a lush landscape that all can enjoy. That's a lot of payback for just changing a nozzle!"*

*Brian Baker, Landscape/Irrigation Engineer  
FLAGLER*

## Major Products

Primary Applications	Rotary Nozzles		Variable ARC Sprays		Fixed ARC Sprays		
	R-VAN	Full-Circle Rotary	HE-VAN	VAN	U-Series	SQ Nozzles	MPR
	Best	Best	Best	Standard	Best	Standard	Standard
Turfgrass	●	●	●	●	●	●	●
Slopes	●	●					
Narrow Strips						●	●
Small Areas	●	●	●			●	
Landscape Beds	●	●	●	●	●	●	●
High Efficiency	●	●	●		●		
High Winds	●	●	●		●		
High Pressure	●	●	●				



## Water Saving Tips

- Rotary Nozzles have efficient water distribution through rotating streams that uniformly deliver water at a low precipitation rate, significantly reducing runoff and erosion.
- HE-VAN nozzles are fully adjustable from 0 to 360 degrees with high uniformity and efficiency. HE-VAN nozzles can reduce the number of variations that need to be carried to cover just about any field challenge. Available in radii from 8' to 15', this high efficient nozzle has you covered.
- U-Series Nozzles are dual-orifice nozzles that have better, more uniform water distribution. Water flowing from both orifices combines to form a continuous water stream and eliminates gaps for more uniform coverage throughout the entire watering area.



### What is a High-Efficiency Nozzle?

#### Typical nozzles – Un-Even Watering

With typical nozzles, part of the lawn may not have enough water and other parts may be over-watered. A large portion of water may be lost to evaporation / misting, and over-spray.

#### High-efficiency nozzles – Even Watering

High-efficiency nozzles provide better coverage. Better coverage means shorter zone run-times while keeping grass healthy. Shorter run-times means you will save up to 25%+ water vs. typical nozzles. Rain Bird's high-efficiency nozzles are also engineered to produce large water droplets to reduce wind drift.











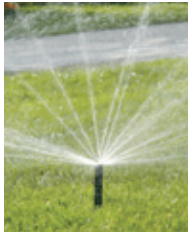

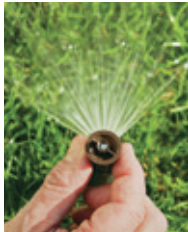
### Standard or Low Precipitation Rate?

#### Low Precipitation Rate Nozzles

Low precipitation rate nozzles are best used in sloped or compacted soil areas to minimize run-off. The low watering rate makes run-times longer.

#### Standard Precipitation Rate Nozzles

Standard precipitation rate nozzles are best used for shorter distance irrigation, and when watering times may be limited due to city ordinances.

Low Precipitation Rate		Standard Precipitation Rate			
High-Efficiency Rotary Nozzles		High-Efficiency Nozzles		Standard Nozzles	
					
					
R-VAN	Rotary	HE-VAN	U-Series	VAN	MPR and SQ
Adjustable Arc (45° - 270°)	Full Circle (360°)	Adjustable Arc (0° - 360°)	Fixed Arc	Adjustable Arc	Fixed Arc

### R-VAN Nozzles

Adjustable arc. 0.6 in/hr Precipitation Rate from 8 to 24 Feet

#### Features

- Adjust arc and radius without tools
- Color coded for easy identification
- Low precipitation rate reduces run-off and erosion
- Maintains efficient performance at high operating pressures without misting or fogging
- The Rain Bird exclusive manual flush feature makes it easy to clear dirt and debris in seconds, assuring reliable performance year after year
- Compatible with all models of Rain Bird spray bodies in addition to a wide variety of risers and adapters
- Matched precipitation rates across radius and arcs simplify the design process
- Matched precipitation rates enable large and small turf areas to be zoned together by mixing R-VAN, R-Series, and 5000 Series rotors with the MPR nozzle set
- Three year trade warranty

#### Operating Specifications

- Pressure Range: 30 to 55 psi (1.4 to 3.8 bar)
- Recommended Operating Pressure: 45 psi (3.1 bar)
- Spacing: 8' to 24' (4.0 to 7.3m)
- Adjustments: Arc and radius should be adjusted while water is running



#### Model

- R-VAN1724
- R-VAN18
- R-VAN14

<sup>1</sup> Rain Bird recommends using 1800 P45 Spray Bodies to maintain optimum nozzle performance in higher pressure situations

Spray Nozzles

#### R-VAN Nozzles meet the requirements of the ASABE/ICC 802-2014 standard

The average DU(LQ) of the applicable products exceed 0.65 distribution uniformity.

Product	Type	Radius	DU(LQ)
R-VAN	Multi-stream, Variable Arc	8 - 24 ft.	> 0.70

To view the complete document of compliance for Rain Bird products that have been tested to meet the requirements of the ASABE/ICC 802-2014 standard and the California MWELO go to: [www.rainbird.com/agency/california/MWELO.htm](http://www.rainbird.com/agency/california/MWELO.htm)

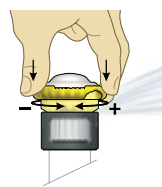

Arc Adjustment

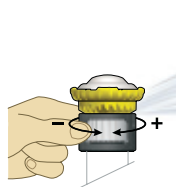

Radius Adjustment

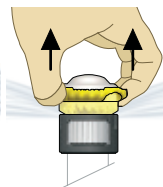

Flush Debris



#### How To Specify

##### R-VAN- 1724

**Radius Range**  
1724: 17' to 24' (5.2 to 7.3m)  
18: 13' to 18' (4.0 to 5.5m)  
14: 8' to 14' (2.4 to 4.6m)

**Model**  
R-VAN Adjustable Rotary Nozzle

#### R-VAN 1724

Nozzle	Pressure psi	Radius ft.	Flow gpm	Precip In/h	Precip In/h
270° Arc 	30	21	2.26	0.70	0.81
	35	22	2.39	0.66	0.76
	40	23	2.55	0.63	0.73
	45	23	2.73	0.64	0.73
	50	24	2.76	0.61	0.70
180° Arc 	30	21	1.41	0.70	0.81
	35	22	1.55	0.66	0.76
	40	23	1.69	0.63	0.73
	45	23	1.83	0.64	0.73
	50	24	1.91	0.61	0.70
90° Arc 	30	21	0.73	0.70	0.81
	35	22	0.78	0.66	0.76
	40	23	0.85	0.63	0.73
	45	23	0.91	0.64	0.73
	50	24	0.98	0.61	0.70



**Note:** All R-VAN nozzles tested on 4" (10.2 cm) pop-ups

■ Square spacing based on 50% diameter of throw

▲ Triangular spacing based on 50% diameter of throw

#### R-VAN 1724



#### METRIC



Nozzle	Pressure bar	Radius m	Flow l/m	Precip mm/h	Precip mm/h
270° Arc 	2.1	6.4	8.56	18	21
	2.4	6.7	9.05	17	19
	2.8	7.0	9.65	16	18
	3.1	7.0	10.33	16	18
	3.4	7.3	10.45	15	18
180° Arc 	3.8	7.3	10.60	15	18
	2.1	6.4	5.34	18	21
	2.4	6.7	5.87	17	19
	2.8	7.0	6.40	16	18
	3.1	7.0	6.93	16	18
90° Arc 	3.4	7.3	7.23	15	18
	3.8	7.3	7.50	15	18
	2.1	6.4	2.76	18	21
	2.4	6.7	2.95	17	19
	2.8	7.0	3.22	16	18



Performance data taken in zero wind conditions



**Note:** Radius reduction over 25% of the normal throw of the nozzle is not recommended

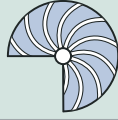

R-VAN18					
Nozzle	Pressure psi	Radius ft.	Flow gpm	■ Precip In/h	▲ Precip In/h
<b>270° Arc</b> 	30	16	1.26	0.65	0.75
	35	16	1.35	0.64	0.74
	40	17	1.42	0.63	0.73
	45	17	1.51	0.64	0.73
	50	18	1.57	0.60	0.69
<b>180° Arc</b> 	30	16	0.85	0.65	0.75
	35	16	0.91	0.64	0.74
	40	17	0.98	0.63	0.73
	45	17	1.01	0.64	0.73
	50	18	1.07	0.60	0.69
<b>90° Arc</b> 	30	16	0.42	0.65	0.75
	35	16	0.47	0.64	0.74
	40	17	0.50	0.63	0.73
	45	17	0.50	0.64	0.73
	50	18	0.54	0.60	0.69

R-VAN18 METRIC					
Nozzle	Pressure bar	Radius m	Flow l/m	■ Precip mm/h	▲ Precip mm/h
<b>270° Arc</b> 	2.1	4.9	4.77	17	19
	2.4	4.9	5.11	16	19
	2.8	5.2	5.38	16	18
	3.1	5.2	5.72	16	18
	3.4	5.5	5.94	15	18
<b>180° Arc</b> 	2.1	4.9	3.22	17	19
	2.4	4.9	3.44	16	19
	2.8	5.2	3.71	16	18
	3.1	5.2	3.82	16	18
	3.4	5.5	4.05	15	18
<b>90° Arc</b> 	2.1	4.9	1.59	17	19
	2.4	4.9	1.78	16	19
	2.8	5.2	1.89	16	18
	3.1	5.2	1.89	16	18
	3.4	5.5	2.04	15	18

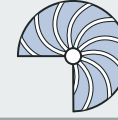
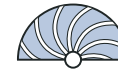
R-VAN14					
Nozzle	Pressure psi	Radius ft.	Flow gpm	■ Precip In/h	▲ Precip In/h
<b>270° Arc</b> 	30	13	0.84	0.64	0.74
	35	13	0.87	0.66	0.76
	40	14	0.92	0.62	0.71
	45	14	0.94	0.60	0.70
	50	15	1.11	0.63	0.73
<b>180° Arc</b> 	30	13	0.56	0.64	0.74
	35	13	0.58	0.66	0.76
	40	14	0.61	0.62	0.71
	45	14	0.63	0.60	0.70
	50	15	0.74	0.63	0.73
<b>90° Arc</b> 	30	13	0.28	0.64	0.74
	35	13	0.29	0.66	0.76
	40	14	0.31	0.62	0.71
	45	14	0.31	0.60	0.70
	50	15	0.37	0.63	0.73

R-VAN14 METRIC					
Nozzle	Pressure bar	Radius m	Flow l/m	■ Precip mm/h	▲ Precip mm/h
<b>270° Arc</b> 	2.1	4.0	3.2	16	19
	2.4	4.0	3.3	17	19
	2.8	4.3	3.6	16	18
	3.1	4.3	3.5	15	18
	3.4	4.6	4.2	16	19
<b>180° Arc</b> 	2.1	4.0	2.1	16	19
	2.4	4.0	2.2	17	19
	2.8	4.3	2.4	16	18
	3.1	4.3	2.3	15	18
	3.4	4.6	2.8	16	19
<b>90° Arc</b> 	2.1	4.0	1.1	16	19
	2.4	4.0	1.1	17	19
	2.8	4.3	1.2	16	18
	3.1	4.3	1.2	15	18
	3.4	4.6	1.4	16	19

**Note:** All R-VAN nozzles tested on 4" (10.2 cm) pop-ups  
 ■ Square spacing based on 50% diameter of throw  
 ▲ Triangular spacing based on 50% diameter of throw

Performance data taken in zero wind conditions  
**Note:** Radius reduction over 25% of the normal throw of the nozzle is not recommended

Spray Nozzles



Did you know that in the real-world,  
**Installs Come in All Shapes**



**HE-VAN Nozzles make installations easy, and water efficient.**

- Full 0° to 360° arc adjustable
- No arc drift over time
- Superior coverage: >0.70 DU[LQ]
- Unique wind-resistant pattern



Note: Use HE-VAN nozzles for specialty patterns (previously U-Series T, TT, TQ nozzles).

Did you know R-VAN and R-Series Nozzles are matched precipitation with the 5000 Series MPR Rotors and can be **installed on the same zone?**

**Use Rotating Nozzles and Rotors on the same zone!**

- Matched precipitation rate (MPR) from 8' to 35'
- Superior coverage – >0.70 DU[LQ]
- Thick, wind-resistant streams – near to far



## Full-Circle Rotary Nozzles

0.6 in/hr Precipitation Rate from 13 to 24 Feet

### Features

- Greater distribution uniformity keeps your landscape green without overwatering
- Thick wind-resistant streams and large water droplets resist prevailing winds and maximize water landing in the target zone
- Low 0.6"/hr precipitation reduces or eliminates run-off on slopes and hard clay soils with 35% less run time than the leading competitor
- Matched precipitation rates enable large and small turf areas to be zoned together by mixing R-Series rotary nozzles, R-VAN, and 5000 Series rotors with the MPR nozzle set
- Three-year trade warranty

### Operating Range

- Spacing: 13 feet to 24 feet (4.0 m to 7.3 m)<sup>1</sup>
- Pressure range: 30 to 55 psi (1.4 to 3.8 bar)
- Recommended Operating Pressure: 45 psi (3.1 bar)<sup>2</sup>

### Models

- Full circle patterns are available to complement the R-VAN product line in two radius ranges:
  - 13' to 18' (4.0m to 5.5m)
  - 17' to 24' (5.2m to 7.3m)

<sup>1</sup> These ranges are based on proper pressure at nozzle

<sup>2</sup> Rain Bird recommends using 1800 P45 Spray Bodies to maintain optimum nozzle performance in higher pressure situations



Full-Circle Rotary Nozzles meet the requirements of the ASABE/ICC 802-2014 standard			
The average DU(LQ) of the applicable products exceed 0.65 distribution uniformity.			
Product	Type	Radius	DU(LQ)
R-Series	Multi-stream, Fixed Arc	13 - 24 ft.	> 0.70

To view the complete document of compliance for Rain Bird products that have been tested to meet the requirements of the ASABE/ICC 802-2014 standard and the California MWELD go to: [www.rainbird.com/agency/california/MWELD.htm](http://www.rainbird.com/agency/california/MWELD.htm)

### How To Specify

**R13-18 F**

Radius Range: 13'-18' (4.0-5.5 m), 17'-24' (5.2-7.3 m)

Pattern: F=Full

Model: Rotary Nozzle

R13-18 Series (Black)					
Arc	Pressure psi	Radius* ft.	Flow gpm	Precip In/h	Precip In/h
	30	16	1.60	0.61	0.70
	35	16	1.73	0.61	0.70
	40	17	1.85	0.61	0.70
	45	18	1.96	0.61	0.70
	50	18	2.07	0.61	0.70
	55	18	2.17	0.61	0.70

R13-18 Series (Black) METRIC					
Arc	Pressure bar	Radius* m	Flow l/m	Precip mm/h	Precip mm/h
	2.1	4.8	6.06	15	18
	2.4	5.0	6.54	15	18
	2.8	5.2	6.99	15	18
	3.1	5.4	7.42	15	18
	3.4	5.5	7.82	15	18
	3.8	5.6	8.20	15	18

R17-24 Series (Yellow)					
Arc	Pressure psi	Radius* ft.	Flow gpm	Precip In/h	Precip In/h
	30	21	3.00	0.65	0.75
	35	22	3.24	0.65	0.75
	40	23	3.46	0.65	0.75
	45	23	3.67	0.65	0.75
	50	24	3.87	0.65	0.75
	55	24	4.06	0.65	0.75

R17-24 Series (Yellow) METRIC					
Arc	Pressure bar	Radius* m	Flow l/m	Precip mm/h	Precip mm/h
	2.1	6.4	11.36	16	19
	2.4	6.7	12.26	16	19
	2.8	6.9	13.10	16	19
	3.1	7.1	13.89	16	19
	3.4	7.3	14.65	16	19
	3.8	7.4	15.37	16	19

**Note:** All Rotary nozzles tested on 4" (10.2 cm) pop-ups  
 ■ Square spacing based on 50% diameter of throw  
 ▲ Triangular spacing based on 50% diameter of throw

Performance data taken in zero wind conditions  
**Note:** Radius reduction over 25% of the normal throw of the nozzle is not recommended

### HE-VAN Series Nozzles

High-Efficiency Variable Arc Spray Nozzles

#### Features

- HE-VAN's even coverage allows you to shorten run times by up to 35%, saving you water and money, while still maintaining a healthy lawn. HE-VAN has more than a 40 percent even-coverage improvement over existing variable arc nozzles
- HE-VAN nozzles have a unique stream pattern, designed for superior coverage and wind resistance. Low-trajectory spray and large water droplets prevent misting and airborne evaporation so the right amount of water is delivered to the right place. Gentle close-in watering eliminates dry-spots around the spray head
- HE-VAN nozzles throw to the exact specified radius, delivering the cleanest edge of any VAN on the market today
- Reduced zone run times, compared to competitive nozzles, help stay within tight watering windows, conserve water, and save money
- With full adjustability from 0° to 360°, you'll be able to efficiently water landscapes of all shapes, while saving time and stocking fewer nozzles
- Matched precipitation rates allow you to install Rain Bird HE-VAN, MPR and U-Series nozzles on the same zone
- HE-VAN nozzles have a tactile click to keep the arc setting from drifting over time
- Three year trade warranty



#### Operating Range

- Spacing: 6 to 15 feet (1.8 to 4.6m) <sup>1</sup>
- Pressure: 15 to 30 psi (1.0 to 2.1 bar)
- Optimum pressure: 30 psi (2.1 bar) <sup>2</sup>

#### Models

- HE-VAN-08: 6 to 8 feet (1.8 to 2.4 m)
- HE-VAN-10: 8 to 10 feet (2.4 to 3.0 m)
- HE-VAN-12: 9 to 12 feet (2.7 to 3.7 m)
- HE-VAN-15: 12 to 15 feet (3.7 to 4.6 m)

<sup>1</sup> These ranges are based on proper pressure at nozzle

<sup>2</sup> Rain Bird recommends using 1800/RD1800 PRS Spray Bodies to maintain optimum nozzle performance in higher pressure situations

#### HE-VAN Nozzles meet the requirements of the ASABE/ICC 802-2014 standard

The average DU(LQ) of the applicable products exceed 0.65 distribution uniformity.

Product	Type	Radius	DU(LQ)
HE-VAN	Spray, Variable Arc	6 - 15 ft.	> 0.70

To view the complete document of compliance for Rain Bird products that have been tested to meet the requirements of the ASABE/ICC 802-2014 standard and the California MWELD go to: [www.rainbird.com/agency/california/MWELD.htm](http://www.rainbird.com/agency/california/MWELD.htm)

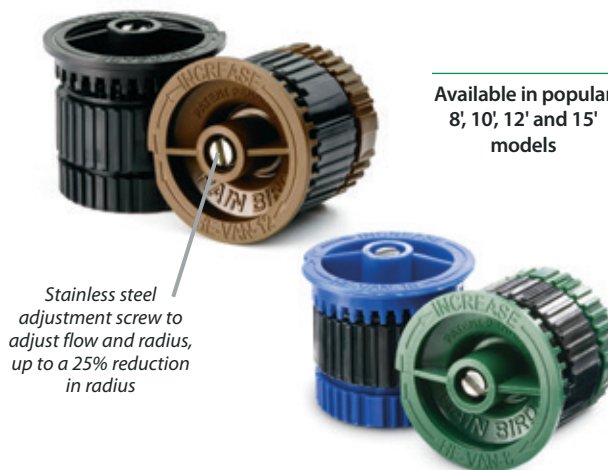

Available in popular 8', 10', 12' and 15' models

Stainless steel adjustment screw to adjust flow and radius, up to a 25% reduction in radius

Fits on all Rain Bird® 1800® Series Spray Heads, UNI-Spray™ Series Spray Heads and Rain Bird Shrub Adapters

#### How To Specify

##### HE-VAN-15

##### Radius Range





- 8: 6 to 8 feet (1.8 to 2.4 m)
- 10: 8 to 10 feet (2.4 to 3.0 m)
- 12: 9 to 12 feet (2.7 to 3.7 m)
- 15: 12 to 15 feet (3.7 to 4.6 m)





##### Feature





VAN: Variable Arc





##### Model

High Efficiency Nozzle

8 Series HE-VAN					
24° Trajectory					
Nozzle	Pressure psi	Radius ft.	Flow gpm	■ Precip In/h	▲ Precip In/h
	15	5	0.83	3.19	3.68
	20	6	0.96	2.56	2.95
	25	7	1.07	2.10	2.42
	30	8	1.17	1.76	2.03
	15	5	0.62	3.19	3.68
	20	6	0.72	2.56	2.95
	25	7	0.80	2.10	2.42
	30	8	0.88	1.76	2.03
	15	5	0.41	3.19	3.68
	20	6	0.48	2.56	2.95
	25	7	0.53	2.10	2.42
	30	8	0.59	1.76	2.03
	15	5	0.21	3.19	3.68
	20	6	0.24	2.56	2.95
	25	7	0.27	2.10	2.42
	30	8	0.29	1.76	2.03





8 Series HE-VAN						METRIC	
24° Trajectory							
Nozzle	Pressure bar	Radius m	Flow m³/h	Flow l/m	■ Precip mm/h	▲ Precip mm/h	
	1.03	1.52	0.19	3.14	82	95	
	1.38	1.83	0.22	3.62	66	76	
	1.72	2.13	0.25	4.05	54	62	
	2.07	2.44	0.27	4.43	45	52	
	1.03	1.52	0.14	2.35	82	95	
	1.38	1.83	0.16	2.72	66	76	
	1.72	2.13	0.18	3.04	54	62	
	2.07	2.44	0.20	3.33	45	52	
	1.03	1.52	0.10	1.57	82	95	
	1.38	1.83	0.11	1.81	66	76	
	1.72	2.13	0.12	2.02	54	62	
	2.07	2.44	0.13	2.22	45	52	
	1.03	1.52	0.05	0.78	82	95	
	1.38	1.83	0.05	0.91	66	76	
	1.72	2.13	0.06	1.01	54	62	
	2.07	2.44	0.07	1.11	45	52	





10 Series HE-VAN					
27° Trajectory					
Nozzle	Pressure psi	Radius ft.	Flow gpm	■ Precip In/h	▲ Precip In/h
	15	7	1.26	2.48	2.86
	20	8	1.46	2.19	2.53
	25	9	1.63	1.94	2.24
	30	10	1.78	1.72	1.98
	15	7	0.95	2.48	2.86
	20	8	1.09	2.19	2.53
	25	9	1.22	1.94	2.24
	30	10	1.34	1.72	1.98
	15	7	0.63	2.48	2.86
	20	8	0.73	2.19	2.53
	25	9	0.81	1.94	2.24
	30	10	0.89	1.72	1.98
	15	7	0.32	2.48	2.86
	20	8	0.36	2.19	2.53
	25	9	0.41	1.94	2.24
	30	10	0.45	1.72	1.98





10 Series HE-VAN						METRIC	
27° Trajectory							
Nozzle	Pressure bar	Radius m	Flow m³/h	Flow l/m	■ Precip mm/h	▲ Precip mm/h	
	1.03	2.13	0.29	4.78	64	74	
	1.38	2.44	0.34	5.52	56	65	
	1.72	2.74	0.37	6.17	50	57	
	2.07	3.05	0.41	6.76	44	51	
	1.03	2.13	0.22	3.59	64	74	
	1.38	2.44	0.25	4.14	56	65	
	1.72	2.74	0.28	4.63	50	57	
	2.07	3.05	0.31	5.07	44	51	
	1.03	2.13	0.15	2.39	64	74	
	1.38	2.44	0.17	2.76	56	65	
	1.72	2.74	0.19	3.09	50	57	
	2.07	3.05	0.21	3.38	44	51	
	1.03	2.13	0.07	1.20	64	74	
	1.38	2.44	0.08	1.38	56	65	
	1.72	2.74	0.09	1.54	50	57	
	2.07	3.05	0.10	1.69	44	51	





Note: All HE-VAN nozzles tested on 4" (10.2 cm) pop-ups  
 ■ Square spacing based on 50% diameter of throw  
 ▲ Triangular spacing based on 50% diameter of throw

Performance data taken in zero wind conditions  
 Note: Radius reduction over 25% of the normal throw of the nozzle is not recommended

12 Series HE-VAN					
23° Trajectory					
Nozzle	Pressure psi	Radius ft.	Flow gpm	■ Precip In/h	▲ Precip In/h
	15	9	1.67	1.99	2.30
	20	10	1.93	1.86	2.15
	25	11	2.16	1.72	1.99
	30	12	2.37	1.58	1.83
	15	9	1.25	1.99	2.30
	20	10	1.45	1.86	2.15
	25	11	1.62	1.72	1.99
	30	12	1.77	1.58	1.83
	15	9	0.84	1.99	2.30
	20	10	0.97	1.86	2.15
	25	11	1.08	1.72	1.99
	30	12	1.18	1.58	1.83
	15	9	0.42	1.99	2.30
	20	10	0.48	1.86	2.15
	25	11	0.54	1.72	1.99
	30	12	0.59	1.58	1.83

12 Series HE-VAN						METRIC	
23° Trajectory							
Nozzle	Pressure bar	Radius m	Flow m³/h	Flow l/m	■ Precip mm/h	▲ Precip mm/h	
	1.0	2.7	0.38	6.33	50.5	58.3	
	1.4	3.0	0.44	7.31	47.3	54.6	
	1.7	3.4	0.49	8.18	43.7	50.4	
	2.1	3.7	0.54	8.96	40.2	46.4	
	1.0	2.7	0.28	4.75	50.5	58.3	
	1.4	3.0	0.33	5.48	47.3	54.6	
	1.7	3.4	0.37	6.16	43.7	50.4	
	2.1	3.7	0.40	6.72	40.2	46.4	
	1.0	2.7	0.19	3.17	50.5	58.3	
	1.4	3.0	0.22	3.66	47.3	54.6	
	1.7	3.4	0.25	4.09	43.7	50.4	
	2.1	3.7	0.27	4.48	40.2	46.4	
	1.0	2.7	0.09	1.58	50.5	58.3	
	1.4	3.0	0.11	1.83	47.3	54.6	
	1.7	3.4	0.12	2.04	43.7	50.4	
	2.1	3.7	0.13	2.24	40.2	46.4	

15 Series HE-VAN					
25° Trajectory					
Nozzle	Pressure psi	Radius ft.	Flow gpm	■ Precip In/h	▲ Precip In/h
	15	11	2.62	2.08	2.40
	20	12	3.02	2.02	2.33
	25	14	3.38	1.66	1.92
	30	15	3.70	1.58	1.83
	15	11	1.96	2.08	2.40
	20	12	2.27	2.02	2.33
	25	14	2.53	1.66	1.92
	30	15	2.78	1.58	1.83
	15	11	1.31	2.08	2.40
	20	12	1.51	2.02	2.33
	25	14	1.69	1.66	1.92
	30	15	1.85	1.58	1.83
	15	11	0.65	2.08	2.40
	20	12	0.76	2.02	2.33
	25	14	0.84	1.66	1.92
	30	15	0.93	1.58	1.83

15 Series HE-VAN						METRIC	
25° Trajectory							
Nozzle	Pressure bar	Radius m	Flow m³/h	Flow l/m	■ Precip mm/h	▲ Precip mm/h	
	1.0	3.4	0.59	9.91	52.9	61.1	
	1.4	3.7	0.69	11.44	51.3	59.3	
	1.7	4.3	0.77	12.79	42.2	48.7	
	2.1	4.6	0.84	14.01	40.2	46.5	
	1.0	3.4	0.45	7.43	52.9	61.1	
	1.4	3.7	0.51	8.58	51.3	59.3	
	1.7	4.3	0.58	9.59	42.2	48.7	
	2.1	4.6	0.63	10.51	40.2	46.5	
	1.0	3.4	0.30	4.95	52.9	61.1	
	1.4	3.7	0.34	5.72	51.3	59.3	
	1.7	4.3	0.38	6.39	42.2	48.7	
	2.1	4.6	0.42	7.00	40.2	46.5	
	1.0	3.4	0.15	2.48	52.9	61.1	
	1.4	3.7	0.17	2.86	51.3	59.3	
	1.7	4.3	0.19	3.20	42.2	48.7	
	2.1	4.6	0.21	3.50	40.2	46.5	

**Note:** All HE-VAN nozzles tested on 4" (10.2 cm) pop-ups

■ Square spacing based on 50% diameter of throw

▲ Triangular spacing based on 50% diameter of throw

Performance data taken in zero wind conditions

**Note:** Radius reduction over 25% of the normal throw of the nozzle is not recommended

## U-Series Nozzles

Dual orifice spray nozzles that use 30% less water<sup>1</sup>

### Features

- Additional orifice for close-in watering minimizes brown spots around the spray head and eliminates gaps in coverage so the entire watering area is more uniformly covered
- Superior coverage for efficient watering. Use up to 30% less water
- Matched precipitation rate with Rain Bird HE-VAN and MPR nozzles
- Five year trade warranty

### Operating Range

- Spacing: 5 to 15 feet (1.7 to 4.6 m)<sup>2</sup>
- Pressure: 15 to 30 psi (1.0 to 2.1 bar)
- Optimum pressure: 30 psi (2.1 bar)<sup>3</sup>

### Models

- U-8 Series: 8-foot Quarter, Half, Full nozzles
- U-10 Series: 10-foot Quarter, Half, Full nozzles
- U-12 Series: 12-foot Quarter, Half, Full nozzles
- U-15 Series: 15-foot Quarter, Half, Full nozzles

<sup>1</sup> When U-Series dual-orifice nozzles are installed instead of standard nozzles on every spray body in the zone. Results may vary based on site-specific conditions such as sprinkler spacing, wind, temperature, soil and grass type

<sup>2</sup> These ranges are based on proper pressure at nozzle.

<sup>3</sup> Rain Bird recommends using 1800/RD1800 PRS Spray Bodies to maintain optimum nozzle performance in higher pressure situations.



U-Series Nozzles

Stainless steel adjustment screw to adjust flow and radius

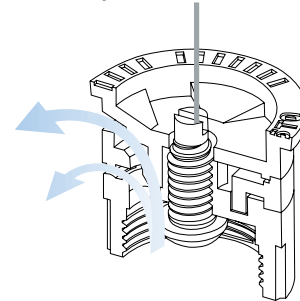

Fits all Rain Bird Spray Bodies and Shrub Adapters

### U-Series Nozzles meet the requirements of the ASABE/ICC 802-2014 standard

The average DU(LQ) of the applicable products exceed 0.65 distribution uniformity.

Product	Type	Radius	DU(LQ)
U-Series	Spray, Fixed Arc	6 - 15 ft.	> 0.70

To view the complete document of compliance for Rain Bird products that have been tested to meet the requirements of the ASABE/ICC 802-2014 standard and the California MWELO go to: [www.rainbird.com/agency/california/MWELO.htm](http://www.rainbird.com/agency/california/MWELO.htm)



U-Series nozzles offer better, more uniform water distribution. Water flowing from both orifices combines to form a continuous water stream. Eliminates gaps for more uniform coverage throughout the entire watering area



U-Series Nozzle with screen



### How To Specify



#### U12H



**Radius Range**  
8: 5-8 feet (1.7-2.4 m)  
10: 7-10 feet (2.1-3.1 m)  
12: 9-12 feet (2.7-3.7 m)  
15: 11-15 feet (3.4-4.6 m)



**Pattern**  
F: Full  
H: Half  
Q: Quarter

**Model**  
U-Series Nozzle

U8 Series					
10° Trajectory					
Nozzle	Pressure psi	Radius ft.	Flow gpm	■ Precip In/h	▲ Precip In/h
 U-8F	15	5	0.74	2.85	3.29
	20	6	0.86	2.30	2.66
	25	7	0.96	1.89	2.18
	30	8	1.05	1.58	1.83
 U-8H	15	5	0.37	2.85	3.29
	20	6	0.42	2.25	2.59
	25	7	0.47	1.85	2.13
	30	8	0.52	1.58	1.83
 U-8Q	15	5	0.18	2.77	3.20
	20	6	0.21	2.25	2.59
	25	7	0.24	1.89	2.18
	30	8	0.26	1.58	1.83

U8 Series					METRIC	
10° Trajectory						
Nozzle	Pressure bar	Radius m	Flow m <sup>3</sup> /h	Flow l/m	■ Precip mm/h	▲ Precip mm/h
 U-8F	1.0	1.7	0.16	2.8	72	84
	1.5	2.1	0.20	3.4	58	68
	2.0	2.4	0.23	3.9	48	55
	2.1	2.4	0.24	4.0	40	46
 U-8H	1.0	1.7	0.08	1.4	72	84
	1.5	2.1	0.10	1.7	57	66
	2.0	2.4	0.12	1.9	47	54
	2.1	2.4	0.12	2.0	40	46
 U-8Q	1.0	1.7	0.04	0.7	70	81
	1.5	2.1	0.05	0.8	57	66
	2.0	2.4	0.06	1.0	48	55
	2.1	2.4	0.06	1.0	40	46

U10 Series					
12° Trajectory					
Nozzle	Pressure psi	Radius ft.	Flow gpm	■ Precip In/h	▲ Precip In/h
 U-10F	15	7	1.16	2.07	2.39
	20	8	1.34	2.01	2.32
	25	9	1.50	1.62	1.87
	30	10	1.64	1.58	1.83
 U-10H	15	7	0.58	2.07	2.39
	20	8	0.67	2.01	2.32
	25	9	0.75	1.62	1.87
	30	10	0.82	1.58	1.83
 U-10Q	15	7	0.29	2.07	2.39
	20	8	0.33	2.01	2.32
	25	9	0.37	1.62	1.87
	30	10	0.41	1.58	1.83

U10 Series					METRIC	
12° Trajectory						
Nozzle	Pressure bar	Radius m	Flow m <sup>3</sup> /h	Flow l/m	■ Precip mm/h	▲ Precip mm/h
 U-10F	1.0	2.1	0.26	4.4	52	60
	1.5	2.6	0.30	5.3	47	55
	2.0	3.0	0.34	6.1	41	48
	2.1	3.1	0.37	6.2	40	46
 U-10H	1.0	2.1	0.13	2.2	52	60
	1.5	2.6	0.15	2.6	47	55
	2.0	3.0	0.17	3.1	41	48
	2.1	3.1	0.19	3.1	40	46
 U-10Q	1.0	2.1	0.07	1.1	52	60
	1.5	2.6	0.08	1.3	47	55
	2.0	3.0	0.08	1.5	41	48
	2.1	3.1	0.09	1.6	40	46

**Note:** All U-Series nozzles tested on 4" (10.2 cm) pop-ups



■ Square spacing based on 50% diameter of throw



▲ Triangular spacing based on 50% diameter of throw



Performance data taken in zero wind conditions



Radius refers to recommended product spacing. Actual radii along arc may vary



U12 Series					
23° Trajectory					
Nozzle	Pressure psi	Radius ft.	Flow gpm	Precip In/h	Precip In/h
 U-12F	15	9	1.80	2.14	2.47
	20	10	2.10	2.02	2.34
	25	11	2.40	1.91	2.21
	30	12	2.60	1.74	2.01
 U-12H	15	9	0.90	2.14	2.47
	20	10	1.05	2.02	2.34
	25	11	1.20	1.91	2.21
	30	12	1.30	1.74	2.01
 U-12Q	15	9	0.45	2.14	2.47
	20	10	0.53	2.02	2.34
	25	11	0.60	1.91	2.21
	30	12	0.65	1.74	2.01

U12 Series						METRIC
23° Trajectory						
Nozzle	Pressure bar	Radius m	Flow m <sup>3</sup> /h	Flow l/m	Precip mm/h	Precip mm/h
 U-12F	1.0	2.7	0.40	6.8	55	63
	1.5	3.2	0.48	8.3	47	54
	2.0	3.6	0.59	9.7	46	53
	2.1	3.7	0.60	9.8	44	51
 U-12H	1.0	2.7	0.20	3.4	55	63
	1.5	3.2	0.24	4.2	47	54
	2.0	3.6	0.30	4.8	46	53
	2.1	3.7	0.30	4.9	44	51
 U-12Q	1.0	2.7	0.10	1.7	55	63
	1.5	3.2	0.12	2.1	47	54
	2.0	3.6	0.15	2.4	46	53
	2.1	3.7	0.15	2.5	44	51

U15 Series					
23° Trajectory					
Nozzle	Pressure psi	Radius ft.	Flow gpm	Precip In/h	Precip In/h
 U-15F	15	11	2.60	2.07	2.39
	20	12	3.00	2.01	2.32
	25	14	3.30	1.62	1.87
	30	15	3.70	1.58	1.83
 U-15H	15	11	1.30	2.07	2.39
	20	12	1.50	2.01	2.32
	25	14	1.65	1.62	1.87
	30	15	1.85	1.58	1.83
 U-15Q	15	11	0.65	2.07	2.39
	20	12	0.75	2.01	2.32
	25	14	0.82	1.62	1.87
	30	15	0.92	1.58	1.83

U15 Series						METRIC
23° Trajectory						
Nozzle	Pressure bar	Radius m	Flow m <sup>3</sup> /h	Flow l/m	Precip mm/h	Precip mm/h
 U-15F	1.0	3.4	0.60	9.8	52	60
	1.5	3.9	0.72	11.8	47	55
	2.0	4.5	0.84	13.7	41	48
	2.1	4.6	0.84	14.0	40	46
 U-15H	1.0	3.4	0.30	4.9	52	60
	1.5	3.9	0.36	5.9	47	55
	2.0	4.5	0.42	6.9	41	48
	2.1	4.6	0.42	7.0	40	46
 U-15Q	1.0	3.4	0.15	2.5	52	60
	1.5	3.9	0.18	2.9	47	55
	2.0	4.5	0.21	3.4	41	48
	2.1	4.6	0.21	3.5	40	46

**Note:** All U-Series nozzles tested on 4" (10.2 cm) pop-ups  
 ■ Square spacing based on 50% diameter of throw  
 ▲ Triangular spacing based on 50% diameter of throw

Performance data taken in zero wind conditions  
 Radius refers to recommended product spacing. Actual radii along arc may vary

Spray Nozzles

### VAN Series Nozzles

Variable Arc Nozzles

#### Features

- A simple twist of the center collar with no special tools increases or decreases the arc setting making it ideal for watering odd shaped areas
- Quickly identify radius with Top Color-coded™ nozzles even when system is not operating
- 12, 15, and 18-VAN have matched precipitation rates with Rain Bird MPR Nozzles
- Three year trade warranty

#### Operating Range

- Spacing: 3 to 18 feet (0.9 m to 5.5 m)<sup>1</sup>
- Pressure: 15 to 30 psi (1.0 to 2.1 bar)
- Optimum pressure: 30 psi (2.1 bar)<sup>2</sup>

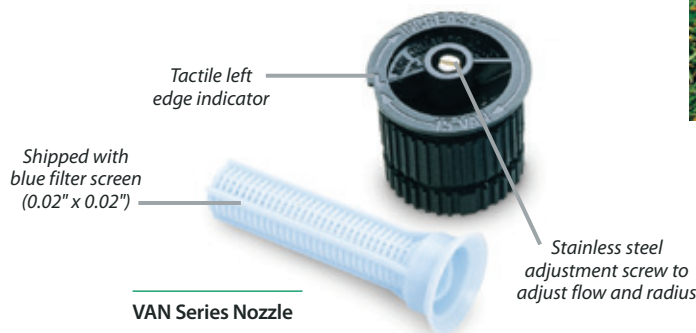

#### Models

- 4-VAN Series: 3 to 4 feet (0.9 to 1.2 m)
- 6-VAN Series: 4 to 6 feet (1.2 to 1.8 m)
- 8-VAN Series: 6 to 8 feet (1.8 to 2.4 m)
- 10-VAN Series: 7 to 10 feet (2.1 to 3.1 m)
- 12-VAN Series: 9 to 12 feet (2.7 to 3.7 m)
- 15-VAN Series: 11 to 15 feet (3.4 to 4.6 m)
- 18-VAN Series: 14 to 18 feet (4.3 to 5.5 m)

<sup>1</sup> These ranges are based on proper pressure at nozzle.

<sup>2</sup> Rain Bird recommends using 1800 PRS Spray Bodies to maintain optimum nozzle performance in higher pressure situations.



Easy to Adjust

#### How To Specify

##### 8 VAN

Radius Range	Nozzle Type
4: 3-4 feet (0.9-1.2 m)	VAN: Variable Arc Nozzle
6: 4-6 feet (1.2-1.8 m)	
8: 6-8 feet (1.8-2.4 m)	
10: 7-10 feet (2.1-3.0 m)	
12: 9-12 feet (2.7-3.7 m)	
15: 11-15 feet (3.4-4.6 m)	
18: 14-18 feet (4.3-5.5 m)	





4 Series VAN					
0° Trajectory					
Nozzle	Pressure psi	Radius ft.	Flow gpm	■ Precip In/h	▲ Precip In/h
330° Arc	15	3	0.62	7.23	8.35
	20	3	0.70	8.17	9.43
	25	4	0.80	5.25	6.06
	30	4	0.88	5.78	6.67
270° Arc	15	3	0.52	7.42	8.57
	20	3	0.58	8.27	9.55
	25	4	0.66	5.29	6.11
180° Arc	15	3	0.32	6.84	7.90
	20	3	0.37	7.91	9.13
	25	4	0.41	4.93	5.69
90° Arc	15	3	0.21	8.98	10.37
	20	3	0.24	10.27	11.86
	25	4	0.26	6.26	7.23
	30	4	0.29	6.98	8.06





**Note:** All VAN nozzles tested on 4" (10.2 cm) pop-ups  
 ■ Square spacing based on 50% diameter of throw  
 ▲ Triangular spacing based on 50% diameter of throw





4 Series VAN						METRIC	
0° Trajectory							
Nozzle	Pressure bar	Radius m	Flow m <sup>3</sup> /h	Flow l/m	■ Precip mm/h	▲ Precip mm/h	
330° Arc	1.0	0.9	0.14	2.3	189	218	
	1.5	1.0	0.17	2.8	183	215	
	2.0	1.2	0.20	3.3	152	176	
	2.1	1.2	0.20	3.3	152	176	
270° Arc	1.0	0.9	0.12	2.0	198	229	
	1.5	1.0	0.14	2.3	187	216	
	2.0	1.2	0.16	2.7	148	171	
	2.1	1.2	0.17	2.8	157	181	
180° Arc	1.0	0.9	0.07	1.2	173	200	
	1.5	1.0	0.09	1.5	180	208	
	2.0	1.2	0.10	1.7	139	161	
	2.1	1.2	0.10	1.7	139	161	
90° Arc	1.0	0.9	0.05	0.8	247	285	
	1.5	1.0	0.06	0.9	240	277	
	2.0	1.2	0.06	1.1	167	193	
	2.1	1.2	0.07	1.1	194	224	





Performance data taken in zero wind conditions

**Note:** Radius reduction over 25% of the normal throw of the nozzle is not recommended

6 Series VAN					
0° Trajectory					
Nozzle	Pressure psi	Radius ft.	Flow gpm	■ Precip In/h	▲ Precip In/h
330° Arc 	15	4	0.85	5.58	6.44
	20	5	0.96	4.03	4.65
	25	5	1.09	4.58	5.29
	30	6	1.20	3.50	4.04
270° Arc 	15	4	0.79	6.34	7.32
	20	5	0.88	4.52	5.22
	25	5	1.00	5.13	5.92
	30	6	1.10	3.92	4.53
180° Arc 	15	4	0.42	5.05	5.83
	20	5	0.49	3.77	4.35
	25	5	0.55	4.24	4.90
	30	6	0.60	3.21	3.71
90° Arc 	15	4	0.26	6.26	7.23
	20	5	0.30	4.62	5.33
	25	5	0.34	5.24	6.05
	30	6	0.37	3.96	4.57

6 Series VAN						METRIC
0° Trajectory						
Nozzle	Pressure bar	Radius m	Flow m³/h	Flow l/m	■ Precip mm/h	▲ Precip mm/h
330° Arc 	1.0	1.2	0.19	3.2	144	166
	1.5	1.5	0.23	3.8	112	129
	2.0	1.8	0.27	4.5	91	105
	2.1	1.8	0.27	4.5	91	105
270° Arc 	1.0	1.2	0.18	3.0	167	193
	1.5	1.5	0.21	3.5	124	143
	2.0	1.8	0.24	4.1	99	114
	2.1	1.8	0.25	4.2	103	119
180° Arc 	1.0	1.2	0.10	1.6	139	161
	1.5	1.5	0.11	1.9	98	113
	2.0	1.8	0.13	2.2	80	92
	2.1	1.8	0.14	2.3	86	99
90° Arc 	1.0	1.2	0.06	1.0	167	193
	1.5	1.5	0.07	1.2	124	143
	2.0	1.8	0.08	1.4	99	114
	2.1	1.8	0.08	1.4	99	114

8 Series VAN					
5° Trajectory					
Nozzle	Pressure psi	Radius ft.	Flow gpm	■ Precip In/h	▲ Precip In/h
330° Arc 	15	6	1.21	3.53	4.07
	20	7	1.36	2.91	3.36
	25	7	1.55	3.32	3.83
	30	8	1.70	2.79	3.22
270° Arc 	15	6	1.11	3.95	4.55
	20	7	1.24	3.24	3.74
	25	7	1.41	3.69	4.25
	30	8	1.55	3.10	3.58
180° Arc 	15	6	0.84	4.49	5.18
	20	7	0.97	3.81	4.40
	25	7	1.09	4.28	4.94
	30	8	1.19	3.58	4.13
90° Arc 	15	6	0.51	5.46	6.29
	20	7	0.59	4.64	5.35
	25	7	0.66	5.19	5.98
	30	8	0.72	4.33	5.00

8 Series VAN						METRIC
5° Trajectory						
Nozzle	Pressure bar	Radius m	Flow m³/h	Flow l/m	■ Precip mm/h	▲ Precip mm/h
330° Arc 	1.0	1.8	0.27	4.6	91	105
	1.5	2.1	0.32	5.4	79	91
	2.0	2.3	0.38	6.3	78	90
	2.1	2.4	0.39	6.4	74	86
270° Arc 	1.0	1.8	0.25	4.2	103	119
	1.5	2.1	0.30	4.9	91	105
	2.0	2.3	0.34	5.8	86	99
	2.1	2.4	0.35	5.9	81	94
180° Arc 	1.0	1.8	0.19	3.2	117	135
	1.5	2.1	0.23	3.8	104	120
	2.0	2.3	0.26	4.4	98	113
	2.1	2.4	0.27	4.5	94	109
90° Arc 	1.0	1.8	0.12	1.9	148	171
	1.5	2.1	0.14	2.3	127	147
	2.0	2.3	0.16	2.7	121	140
	2.1	2.4	0.16	2.7	111	128

Note: All VAN nozzles tested on 4" (10.2 cm) pop-ups  
 ■ Square spacing based on 50% diameter of throw  
 ▲ Triangular spacing based on 50% diameter of throw





Performance data taken in zero wind conditions  
 Note: Radius reduction over 25% of the normal throw of the nozzle is not recommended





## Did you know?





You can use HE-VAN nozzles to have better coverage and save water vs. VAN nozzles.





- Stronger streams and larger water droplets for increased wind resistance.
- Superior close-in watering and edges provide better coverage.
- Shortened run times saves up to 35% in water



10 Series VAN					
10° Trajectory					
Nozzle	Pressure psi	Radius ft.	Flow gpm	■ Precip In/h	▲ Precip In/h
	15	7	1.93	3.80	4.39
	20	8	2.32	3.50	4.04
	25	9	2.52	3.00	3.46
	30	10	2.60	2.50	2.89
	15	7	1.45	3.80	4.39
	20	8	1.75	3.50	4.04
	25	9	1.89	3.00	3.46
	30	10	2.10	2.70	3.12
	15	7	0.97	3.80	4.39
	20	8	1.20	3.50	4.04
	25	9	1.26	3.00	3.46
	30	10	1.45	2.80	3.23
	15	7	0.48	3.80	4.39
	20	8	0.58	3.50	4.04
	25	9	0.63	3.00	3.46
	30	10	0.75	2.90	3.35

10 Series VAN					METRIC	
10° Trajectory						
Nozzle	Pressure bar	Radius m	Flow m <sup>3</sup> /h	Flow l/m	■ Precip mm/h	▲ Precip mm/h
	1.0	2.1	0.44	7.3	96	111
	1.5	2.4	0.53	9.0	89	103
	2.0	2.7	0.57	9.8	76	88
	2.1	3.1	0.59	9.8	63	73
	1.0	2.1	0.33	5.5	96	111
	1.5	2.4	0.4	6.8	89	103
	2.0	2.7	0.43	7.8	76	88
	2.1	3.1	0.48	7.9	68	79
	1.0	2.1	0.22	3.7	96	111
	1.5	2.4	0.27	4.6	89	103
	2.0	2.7	0.29	5.3	76	88
	2.1	3.1	0.33	5.5	71	82
	1.0	2.1	0.11	1.8	96	111
	1.5	2.4	0.13	2.3	89	103
	2.0	2.7	0.14	2.7	76	88
	2.1	3.1	0.17	2.8	73	85

12 Series VAN					
15° Trajectory					
Nozzle	Pressure psi	Radius ft.	Flow gpm	■ Precip In/h	▲ Precip In/h
	15	9	1.56	1.86	2.14
	20	10	1.86	1.79	2.06
	25	11	2.12	1.68	1.95
	30	12	2.36	1.58	1.82
	15	9	1.17	1.86	2.14
	20	10	1.39	1.79	2.06
	25	11	1.59	1.68	1.94
	30	12	1.77	1.58	1.82
	15	9	0.78	1.86	2.14
	20	10	0.93	1.79	2.06
	25	11	1.06	1.68	1.95
	30	12	1.18	1.58	1.82
	15	9	0.39	1.86	2.14
	20	10	0.46	1.79	2.06
	25	11	0.53	1.68	1.95
	30	12	0.59	1.58	1.82

12 Series VAN					METRIC	
15° Trajectory						
Nozzle	Pressure bar	Radius m	Flow m <sup>3</sup> /h	Flow l/m	■ Precip mm/h	▲ Precip mm/h
	1.0	2.7	0.35	5.80	48	55
	1.5	3.2	0.44	7.37	43	50
	2.0	3.6	0.52	8.75	41	47
	2.1	3.7	0.54	9.02	40	46
	1.0	2.7	0.26	4.35	48	55
	1.5	3.2	0.33	5.53	43	50
	2.0	3.6	0.39	6.56	41	47
	2.1	3.7	0.41	6.76	40	46
	1.0	2.7	0.17	2.90	48	55
	1.5	3.2	0.22	3.69	43	50
	2.0	3.6	0.26	4.37	41	47
	2.1	3.7	0.27	4.51	40	46
	1.0	2.7	0.09	1.45	48	55
	1.5	3.2	0.11	1.84	43	50
	2.0	3.6	0.13	2.19	41	47
	2.1	3.7	0.14	2.25	40	46

**Note:** All VAN nozzles tested on 4" (10.2 cm) pop-ups  
 ■ Square spacing based on 50% diameter of throw  
 ▲ Triangular spacing based on 50% diameter of throw





Performance data taken in zero wind conditions  
**Note:** Radius reduction over 25% of the normal throw of the nozzle is not recommended





### Did you know?





**You can use HE-VAN nozzles to have better coverage and save water vs. VAN nozzles.**





- Stronger streams and larger water droplets for increased wind resistance.
- Superior close-in watering and edges provide better coverage.
- Shortened run times saves up to 35% in water



15 Series VAN					
23° Trajectory					
Nozzle	Pressure psi	Radius ft.	Flow gpm	■ Precip In/h	▲ Precip In/h
360° Arc 	15	11	2.60	2.07	2.39
	20	12	3.00	2.01	2.32
	25	14	3.30	1.62	1.87
	30	15	3.70	1.58	1.83
270° Arc 	15	11	1.95	2.07	2.39
	20	12	2.25	2.01	2.32
	25	14	2.48	1.62	1.87
	30	15	2.78	1.58	1.83
180° Arc 	15	11	1.30	2.07	2.39
	20	12	1.50	2.01	2.32
	25	14	1.65	1.62	1.87
	30	15	1.85	1.58	1.83
90° Arc 	15	11	0.65	2.07	2.39
	20	12	0.75	2.01	2.32
	25	14	0.82	1.62	1.87
	30	15	0.92	1.58	1.83

15 Series VAN						METRIC
23° Trajectory						
Nozzle	Pressure bar	Radius m	Flow m³/h	Flow l/m	■ Precip mm/h	▲ Precip mm/h
360° Arc 	1.0	3.4	0.60	9.8	52	60
	1.5	3.9	0.72	11.8	47	55
	2.0	4.5	0.84	13.7	41	48
	2.1	4.6	0.84	14.0	40	46
270° Arc 	1.0	3.4	0.45	7.4	52	60
	1.5	3.9	0.54	8.8	47	55
	2.0	4.5	0.63	10.3	41	48
	2.1	4.6	0.63	10.5	40	46
180° Arc 	1.0	3.4	0.30	4.9	52	60
	1.5	3.9	0.36	5.9	47	55
	2.0	4.5	0.42	6.9	41	48
	2.1	4.6	0.42	7.0	40	46
90° Arc 	1.0	3.4	0.15	2.5	52	60
	1.5	3.9	0.18	2.9	47	55
	2.0	4.5	0.21	3.4	41	48
	2.1	4.6	0.21	3.5	40	46

18 Series VAN					
26° Trajectory					
Nozzle	Pressure psi	Radius ft.	Flow gpm	■ Precip In/h	▲ Precip In/h
360° Arc 	15	14	4.21	2.07	2.39
	20	15	4.70	2.01	2.32
	25	17	4.86	1.62	1.87
	30	18	5.32	1.58	1.83
270° Arc 	15	14	3.16	2.07	2.39
	20	15	3.52	2.01	2.32
	25	17	3.65	1.62	1.87
	30	18	3.99	1.58	1.83
180° Arc 	15	14	2.11	2.07	2.39
	20	15	2.35	2.01	2.32
	25	17	2.43	1.62	1.87
	30	18	2.66	1.58	1.83
90° Arc 	15	14	1.05	2.07	2.39
	20	15	1.17	2.01	2.32
	25	17	1.22	1.62	1.87
	30	18	1.33	1.58	1.83

18 Series VAN						METRIC
26° Trajectory						
Nozzle	Pressure bar	Radius m	Flow m³/h	Flow l/m	■ Precip mm/h	▲ Precip mm/h
360° Arc 	1.0	4.3	0.96	15.9	52	60
	1.5	4.8	1.07	18.0	47	55
	2.0	5.4	1.20	19.8	41	48
	2.1	5.5	1.21	20.1	40	46
270° Arc 	1.0	4.3	0.72	12.0	52	60
	1.5	4.8	0.80	13.5	47	55
	2.0	5.4	0.90	14.8	41	48
	2.1	5.5	0.91	15.1	40	46
180° Arc 	1.0	4.3	0.48	8.0	52	60
	1.5	4.8	0.54	9.0	47	55
	2.0	5.4	0.60	9.9	41	48
	2.1	5.5	0.61	10.1	40	46
90° Arc 	1.0	4.3	0.24	4.0	52	60
	1.5	4.8	0.27	4.5	47	55
	2.0	5.4	0.30	5.0	41	48
	2.1	5.5	0.30	5.0	40	46

Note: All VAN nozzles tested on 4" (10.2 cm) pop-ups  
 ■ Square spacing based on 50% diameter of throw  
 ▲ Triangular spacing based on 50% diameter of throw

Performance data taken in zero wind conditions  
 Note: Radius reduction over 25% of the normal throw of the nozzle is not recommended

Did you know?

You can use HE-VAN nozzles to have better coverage and save water vs. VAN nozzles.

- Stronger streams and larger water droplets for increased wind resistance.
- Superior close-in watering and edges provide better coverage.
- Shortened run times saves up to 35% in water



### MPR Spray Nozzles

Matched Precipitation Rate Nozzles

#### Features

- Matched precipitation rates across sets and patterns in 5 Series, 8 Series, 10 Series, 12 Series, and 15 Series for even water distribution and design flexibility
- MPR Nozzles are installed by more contractors than all other brands combined
- Quickly identify radius and arc with Top Color-coded™ nozzles even when system is not operating
- Three year trade warranty

#### Operating Range

- Spacing: 3 to 15 feet (0.9 to 4.6 m)<sup>1</sup>
- Pressure: 15 to 30 psi (1 to 2.1 bar)
- Optimum pressure: 30 psi (2.1 bar)<sup>2</sup>

#### Models

- 5 Series: Quarter, Half, Full Nozzles
- 5 Series: Bubbler Nozzles
- 8 Series: Quarter, Half, Full Nozzles
- 8 FLT Series: Designed for lower trajectory applications, such as windy areas
- 10 Series Nozzles
- 12 Series Nozzles
- 15 Series: Quarter, Half, Full Nozzles
- 15 Strip Series Nozzles

<sup>1</sup> These ranges are based on proper pressure at nozzle.

<sup>2</sup> Rain Bird recommends using 1800 PRS Spray Bodies to maintain optimum nozzle performance in higher pressure situations.

Spray Nozzles



Rain Bird® MPR Nozzles, The Industry Standard





MPR Nozzle and Screen

#### How To Specify



5 F

Pattern  
F: Full  
H: Half  
Q: Quarter

MPR Radius Range  
5: 3-5 feet (1.1-1.5 m)  
8: 5-8 feet (1.7-2.4 m)  
10: 7-10 feet (2.1-3.1)  
12: 19-2 feet (2.7-3.7 m)  
15: 11-15 feet (3.4-4.6 m)



5 Series MPR						
5° Trajectory						
Nozzle	Pressure psi	Radius ft.	Flow gpm	■ Precip In/h	▲ Precip In/h	
5F 	15	3	0.29	3.10	3.58	
	20	4	0.33	1.99	2.29	
	25	4	0.37	2.23	2.57	
	30	5	0.41	1.58	1.83	
5H 	15	3	0.14	3.00	3.46	
	20	4	0.16	1.93	2.22	
	25	4	0.18	2.17	2.50	
5Q 	30	5	0.20	1.54	1.78	
	15	3	0.07	3.00	3.46	
	20	4	0.08	1.93	2.22	
	25	4	0.09	2.17	2.50	
	30	5	0.10	1.54	1.78	



**Note:** All MPR nozzles tested on 4" (10.2 cm) pop-ups  
 ■ Square spacing based on 50% diameter of throw  
 ▲ Triangular spacing based on 50% diameter of throw



5 Series MPR							METRIC	
5° Trajectory								
Nozzle	Pressure bar	Radius m	Flow m <sup>3</sup> /h	Flow l/m	■ Precip mm/h	▲ Precip mm/h		
5F 	1.0	1.1	0.06	1.1	79	91		
	1.5	1.3	0.08	1.4	51	58		
	2.0	1.5	0.09	1.6	57	65		
	2.1	1.5	0.09	1.6	40	46		
5H 	1.0	1.1	0.03	0.5	76	88		
	1.5	1.3	0.04	0.7	49	56		
	2.0	1.5	0.04	0.7	55	64		
5Q 	2.1	1.5	0.05	0.9	39	45		
	1.0	1.1	0.02	0.4	76	88		
	1.5	1.3	0.02	0.4	49	56		
	2.0	1.5	0.02	0.4	55	64		
	2.1	1.5	0.02	0.4	39	45		



Performance data taken in zero wind conditions



**Note:** Radius reduction over 25% of the normal throw of the nozzle is not recommended



8 Series MPR					
10° Trajectory					
Nozzle	Pressure psi	Radius ft.	Flow gpm	Precip In/h	Precip In/h
8F 	15	5	0.74	2.85	3.29
	20	6	0.86	2.30	2.66
	25	7	0.96	1.89	2.18
	30	8	1.05	1.58	1.82
8H 	15	5	0.37	2.85	3.29
	20	6	0.42	2.25	2.59
	25	7	0.47	1.85	2.13
	30	8	0.52	1.56	1.81
8Q 	15	5	0.18	2.77	3.20
	20	6	0.21	2.25	2.59
	25	7	0.24	1.89	2.18
	30	8	0.26	1.56	1.81

8 Series MPR						METRIC
10° Trajectory						
Nozzle	Pressure bar	Radius m	Flow m³/h	Flow l/m	Precip mm/h	Precip mm/h
8F 	1.0	1.7	0.16	2.8	72	84
	1.5	2.1	0.20	3.4	58	68
	2.0	2.4	0.23	3.9	48	55
	2.1	2.4	0.24	4.0	40	46
8H 	1.0	1.7	0.08	1.4	72	84
	1.5	2.1	0.10	1.7	57	66
	2.0	2.4	0.12	1.9	47	54
	2.1	2.4	0.12	2.0	40	46
8Q 	1.0	1.7	0.04	0.7	70	81
	1.5	2.1	0.05	0.8	57	66
	2.0	2.4	0.06	1.0	48	55
	2.1	2.4	0.06	1.0	40	46

10 Series MPR					
15° Trajectory					
Nozzle	Pressure psi	Radius ft.	Flow gpm	Precip In/h	Precip In/h
10F 	15	7	1.16	2.28	2.63
	20	8	1.30	1.96	2.26
	25	9	1.44	1.71	1.98
	30	10	1.58	1.52	1.75
10H 	15	7	0.58	2.28	2.63
	20	8	0.65	1.96	2.26
	25	9	0.72	1.71	1.98
	30	10	0.79	1.52	1.75
10Q 	15	7	0.29	2.28	2.63
	20	8	0.33	1.96	2.26
	25	9	0.36	1.71	1.98
	30	10	0.39	1.52	1.75

10 Series MPR						METRIC
15° Trajectory						
Nozzle	Pressure bar	Radius m	Flow m³/h	Flow l/m	Precip mm/h	Precip mm/h
10F 	1.0	2.1	0.26	4.2	58	67
	1.5	2.4	0.29	4.8	50	58
	2.0	3.0	0.35	6.0	39	45
	2.1	3.1	0.36	6.0	37	43
10H 	1.0	2.1	0.13	2.4	58	67
	1.5	2.4	0.14	2.4	50	58
	2.0	3.0	0.18	3.0	39	45
	2.1	3.1	0.18	3.0	37	43
10Q 	1.0	2.1	0.06	1.2	58	67
	1.5	2.4	0.07	1.2	50	58
	2.0	3.0	0.09	1.2	39	45
	2.1	3.1	0.09	1.2	37	43



12 Series MPR					
30° Trajectory					
Nozzle	Pressure psi	Radius ft.	Flow gpm	Precip In/h	Precip In/h
12F 	15	9	1.80	2.14	2.47
	20	10	2.10	2.02	2.34
	25	11	2.40	1.91	2.21
	30	12	2.60	1.74	2.01
12H 	15	9	0.90	2.14	2.47
	20	10	1.05	2.02	2.34
	25	11	1.20	1.91	2.21
	30	12	1.30	1.74	2.01
12Q 	15	9	0.45	2.14	2.47
	20	10	0.53	2.02	2.34
	25	11	0.60	1.91	2.21
	30	12	0.65	1.74	2.01



12 Series MPR						METRIC
30° Trajectory						
Nozzle	Pressure bar	Radius m	Flow m³/h	Flow l/m	Precip mm/h	Precip mm/h
12F 	1.0	2.7	0.40	6.8	55	63
	1.5	3.2	0.48	8.3	47	54
	2.0	3.6	0.59	9.7	46	53
	2.1	3.7	0.60	9.8	44	51
12H 	1.0	2.7	0.20	3.4	55	63
	1.5	3.2	0.24	4.2	47	54
	2.0	3.6	0.30	4.9	46	53
	2.1	3.7	0.30	4.9	44	51
12Q 	1.0	2.7	0.10	1.7	55	63
	1.5	3.2	0.12	2.1	47	54
	2.0	3.6	0.15	2.4	46	53
	2.1	3.7	0.15	2.5	44	51

Note: All MPR nozzles tested on 4" (10.2 cm) pop-ups  
 ■ Square spacing based on 50% diameter of throw  
 ▲ Triangular spacing based on 50% diameter of throw

Performance data taken in zero wind conditions  
 Note: Radius reduction over 25% of the normal throw of the nozzle is not recommended





Spray Nozzles





15 Series MPR					
30° Trajectory					
Nozzle	Pressure psi	Radius ft.	Flow gpm	■ Precip In/h	▲ Precip In/h
15F 	15	11	2.60	2.07	2.39
	20	12	3.00	2.01	2.32
	25	14	3.30	1.62	1.87
	30	15	3.70	1.58	1.83
15H 	15	11	1.30	2.07	2.39
	20	12	1.50	2.01	2.32
	25	14	1.65	1.62	1.87
	30	15	1.85	1.58	1.83
15Q 	15	11	0.65	2.07	2.39
	20	12	0.75	2.01	2.32
	25	14	0.82	1.62	1.87
	30	15	0.92	1.58	1.83

15 Series MPR					METRIC	
30° Trajectory						
Nozzle	Pressure bar	Radius m	Flow m³/h	Flow l/m	■ Precip mm/h	▲ Precip mm/h
15F 	1.0	3.4	0.60	9.8	52	60
	1.5	3.9	0.72	11.8	47	55
	2.0	4.5	0.84	13.7	41	48
	2.1	4.6	0.84	14.0	40	46
	2.1	4.6	0.84	14.0	40	46
15H 	1.0	3.4	0.30	4.9	52	60
	1.5	3.9	0.36	5.9	47	55
	2.0	4.5	0.42	6.8	41	48
	2.1	4.6	0.42	7.0	40	46
	2.1	4.6	0.42	7.0	40	46
15Q 	1.0	3.4	0.15	2.5	52	60
	1.5	3.9	0.18	2.9	47	55
	2.0	4.5	0.21	3.4	41	48
	2.1	4.6	0.21	3.5	40	46
	2.1	4.6	0.21	3.5	40	46

**Note:** All MPR nozzles tested on 4" (10.2 cm) pop-ups  
 ■ Square spacing based on 50% diameter of throw  
 ▲ Triangular spacing based on 50% diameter of throw

Performance data taken in zero wind conditions  
**Note:** Radius reduction over 25% of the normal throw of the nozzle is not recommended

5 Series MPR Stream Bubbler Nozzles			
0° Trajectory			
Nozzle	Pressure psi	Radius ft.	Flow gpm
5F-B 	15	5	1.50
	20	5	1.50
	25	5	1.50
	30	5	1.50
5H-B 	15	5	1.00
	20	5	1.00
	25	5	1.00
	30	5	1.00
5Q-B 	15	5	0.50
	20	5	0.50
	25	5	0.50
	30	5	0.50
5CST-B 	15	5	0.50
	20	5	0.50
	25	5	0.50
	30	5	0.50

5 Series MPR Stream Bubbler Nozzles					METRIC
0° Trajectory					
Nozzle	Pressure bar	Radius m	Flow m³/h	Flow l/m	
5F-B 	1.0	1.5	0.35	5.7	
	1.5	1.5	0.35	5.7	
	2.0	1.5	0.35	5.7	
	2.1	1.5	0.35	5.7	
	2.1	1.5	0.35	5.7	
5H-B 	1.0	1.5	0.23	3.8	
	1.5	1.5	0.23	3.8	
	2.0	1.5	0.23	3.8	
	2.1	1.5	0.23	3.8	
	2.1	1.5	0.23	3.8	
5Q-B 	1.0	1.5	0.12	1.9	
	1.5	1.5	0.12	1.9	
	2.0	1.5	0.12	1.9	
	2.1	1.5	0.12	1.9	
	2.1	1.5	0.12	1.9	
5CST-B 	1.0	1.5	0.12	1.9	
	1.5	1.5	0.12	1.9	
	2.0	1.5	0.12	1.9	
	2.1	1.5	0.12	1.9	
	2.1	1.5	0.12	1.9	

**Note:** Indicates adjusted radius at psi shown  
**Note:** Flow at adjusted radius of 5 feet (1.5 m)







### Did you know?

**You can use HE-VAN or U-Series nozzles to have better coverage and save water vs. MPR nozzles.**







- Stronger streams and larger water droplets for increased wind resistance.
- Superior close-in watering and edges provide better coverage.
- Shortened run times saves up to 35% in water







15 Strip Series			
30° Trajectory			
Nozzle	Pressure psi	W x L ft.	Flow gpm
15EST 	15	4 x 13	0.45
	20	4 x 14	0.50
	25	4 x 14	0.56
	30	4 x 15	0.61
15CST 	15	4 x 26	0.89
	20	4 x 28	1.00
	25	4 x 28	1.11
	30	4 x 30	1.21
15RCS 	15	3 x 11	0.35
	20	3 x 12	0.40
	25	4 x 14	0.45
	30	4 x 15	0.49
15LCS 	15	3 x 11	0.35
	20	3 x 12	0.40
	25	4 x 14	0.45
	30	4 x 15	0.49
15SST 	15	4 x 26	0.89
	20	4 x 28	1.00
	25	4 x 28	1.11
	30	4 x 30	1.21
9SST 	15	9 x 15	1.34
	20	9 x 16	1.47
	25	9 x 18	1.60
	30	9 x 18	1.73



W = Width of coverage pattern L = Length of coverage pattern  
**Note:** Radius reduction over 25% of the normal throw of the nozzle is not recommended

15 Strip Series				METRIC
30° Trajectory				
Nozzle	Pressure bar	W x L m	Flow m <sup>3</sup> /h	Flow l/m
15EST 	1.0	1.2 x 4.0	0.10	1.7
	1.5	1.2 x 4.3	0.11	2.0
	2.0	1.2 x 4.3	0.13	2.3
	2.1	1.2 x 4.6	0.14	2.3
	2.1	1.2 x 4.6	0.14	2.3
15CST 	1.0	1.2 x 7.9	0.20	3.4
	1.5	1.2 x 8.5	0.23	4.0
	2.0	1.2 x 8.5	0.25	4.5
	2.1	1.2 x 9.2	0.27	4.6
	2.1	1.2 x 9.2	0.27	4.6
15RCS 	1.0	0.8 x 3.2	0.08	1.3
	1.5	1.0 x 3.9	0.09	1.6
	2.0	1.2 x 4.5	0.11	1.8
	2.1	1.2 x 4.6	0.11	1.9
	2.1	1.2 x 4.6	0.11	1.9
15LCS 	1.0	0.8 x 3.2	0.08	1.3
	1.5	1.0 x 3.9	0.09	1.6
	2.0	1.2 x 4.5	0.11	1.8
	2.1	1.2 x 4.6	0.11	1.9
	2.1	1.2 x 4.6	0.11	1.9
15SST 	1.0	1.2 x 7.9	0.20	3.4
	1.5	1.2 x 8.5	0.23	4.0
	2.0	1.2 x 8.5	0.25	4.5
	2.1	1.2 x 9.2	0.27	4.6
	2.1	1.2 x 9.2	0.27	4.6
9SST 	1.0	2.7 x 4.6	0.30	5.1
	1.5	2.7 x 4.9	0.33	5.8
	2.0	2.7 x 5.5	0.36	6.5
	2.1	2.7 x 5.5	0.39	6.5
	2.1	2.7 x 5.5	0.39	6.5

Performance data taken in zero wind conditions

8 FLT Series MPR					
5° Trajectory					
Nozzle	Pressure psi	Radius ft.	Flow gpm	■ Precip In/h	▲ Precip In/h
8H-FLT 	15	6	0.56	3.36	3.88
	20	7	0.65	2.91	3.36
	25	7	0.72	2.60	3.01
	30	8	0.79	2.38	2.75
8Q-FLT 	15	6	0.28	3.32	3.83
	20	7	0.32	2.87	3.32
	25	7	0.36	2.57	2.97
	30	8	0.39	2.35	2.71

**Note:** All MPR nozzles tested on 4" (10.2 cm) pop-ups  
 ■ Square spacing based on 50% diameter of throw  
 ▲ Triangular spacing based on 50% diameter of throw

8 FLT Series MPR						METRIC
5° Trajectory						
Nozzle	Pressure bar	Radius m	Flow m <sup>3</sup> /h	Flow l/m	■ Precip mm/h	▲ Precip mm/h
8H-FLT 	1.0	1.7	0.12	2.1	87	101
	1.5	2.1	0.15	2.6	71	82
	2.0	2.4	0.18	2.9	62	71
	2.1	2.4	0.18	3.0	60	70
	2.1	2.4	0.18	3.0	60	70
8Q-FLT 	1.0	1.7	0.06	1.1	86	100
	1.5	2.1	0.07	1.3	71	81
	2.0	2.4	0.09	1.4	61	71
	2.1	2.4	0.09	1.5	60	69
	2.1	2.4	0.09	1.5	60	69

Performance data taken in zero wind conditions  
**Note:** Radius reduction over 25% of the normal throw of the nozzle is not recommended



SQ Nozzle Installed on PolyFlex Riser with Nozzle Adapter



SQ Nozzles with Screens

### One Nozzle...Two Throws

With a simple turn of the nozzle to the next preset stop, the Rain Bird SQ Nozzle adjusts from a 2.5' (0.8 m) throw to a 4' (1.2 m) throw. It's like having two nozzles in one.



### Can be used on...

The SQ Nozzle is an ideal solution for a wide range of difficult-to-design areas, thanks to its compatibility with popular irrigation products.

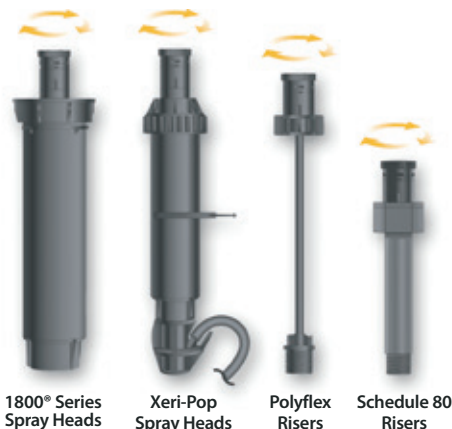

1800® Series Spray Heads

Xeri-Pop Spray Heads

Polyflex Risers

Schedule 80 Risers

## SQ Series, Square Pattern Nozzles

The Most Precise and Efficient, Low-Volume Spray Solution for Irrigation of Small Areas with Dense Plantings

### Features

- Square spray pattern and pressure compensation offer increased efficiency and control, reducing overspray, property damage and liability
- Simplify design and installation with the flexibility of applications: one nozzle throws 2.5' or 4' (0.8 m or 1.2 m) and can be used on a variety of spray heads and risers
- Meets micro irrigation system requirement for less than 26 gph flow rate at 30 psi
- Square spray pattern with edge-to-edge coverage allows you to easily design and install in small spaces
- Pressure compensation design delivers uniform flow over the pressure range
- Available in 3 models—quarter, half and full patterns with matched precipitation rate
  - Virtually no-mist performance from 20 psi to 50 psi
  - Two throw distances in each nozzle. One simple click adjusts to 2.5' or 4' (0.8 m or 1.2 m)
  - Shipped with blue filter screen (0.02" x 0.02") to maintain precise distance of flow, and to prevent clogging
- Compatible with all 1800 Sprays, Xeri-Pops, New PolyFlex Riser Adapter, UNI-Spray and SCH 80 risers

### Operating Range

- Pressure: 20 to 50 psi (1.4 to 3.5 bar)
- Flow rates: 6, 12 and 24 gph (22.7, 45.4 and 90.8 l/h)
- Required filtration: 40 mesh

*Note: See page 119 for SQ Series performance charts.*

### Models

- SQ-QTR: SQ Nozzle, quarter pattern
- SQ-HLF: SQ Nozzle, half pattern
- SQ-FUL: SQ Nozzle, full pattern
- SQ-ADP12: SQ Nozzle Adapter with 12" PolyFlex Riser
- SQ-ADP24: SQ Nozzle Adapter with 24" PolyFlex Riser
- SQ-ADP: SQ PolyFlex Riser Adapter only

\* *Note: A PA-8S Plastic Shrub Adapter (see page 10) is needed when using an SQ Series Nozzle mounted on a SCH 80 riser.*

## 1300A-F

Adjustable Full-Circle Bubbler

### Features

- Stainless Steel adjustment screw regulates flow and radius for spacing between from 1 to 3 feet (0.3 m to 0.9 m) apart
- Non-corrosive plastic and stainless steel construction for long life
- Shipped with SR-050 1/2" (15/21) inlet filter screen for easy installation and resistance to debris
- Operates over a wide range of pressures
- Five year trade warranty

### Operating Range

- Flow: 1.0 to 2.3 gpm (3.6 to 8.4 l/m)
- Spacing: 1 to 3 feet (0.3 to 0.9 m)<sup>1</sup>
- Pressure: 10 to 60 psi (0.7 to 4.1 bar)<sup>2</sup>

### Model

- 1300A-F

<sup>1</sup> These ranges are based on proper pressure at nozzle

<sup>2</sup> Rain Bird recommends using 1800 PRS Spray Bodies to maintain optimum nozzle performance in higher pressure situations

1300A-F		
Nozzle	Pressure psi	Flow gpm
F	10	1.0
	20	1.4
	30	1.7
	40	1.9
	50	2.1
	60	2.3

1300A-F		METRIC	
Nozzle	Pressure bar	Flow m <sup>3</sup> /h	Flow l/m
F	0.7	0.23	3.6
	1.0	0.26	4.2
	1.5	0.30	4.8
	2.0	0.34	5.4
	2.5	0.39	6.0
	3.0	0.43	7.2
	3.5	0.48	7.8
	4.0	0.52	8.4
	4.1	0.53	8.4



1300A-F

## 1400 Series

Pressure Compensating Full-Circle Bubblers

### Features

- Low flow rates allow water to be absorbed as needed. Reduces runoff
- Flow will not fluctuate at pressures between 20 and 90 psi (1.4 to 6.2 bar)
- Flow is not adjustable for increased vandal resistance
- Shipped with special SR-050 1/2" (15/21) bubbler filter screen for easy installation and resistance to debris
- Trickle pattern on models 1401 and 1402; umbrella pattern on models 1404 and 1408
- Five-year trade warranty



1400 Series

### Operating Range

- Flow: 0.25 to 2.00 gpm (1.2 to 7.2 l/m)
- Spacing: 1 to 3 feet (0.3 to 0.9 m)\*
- Pressure: 20 to 90 psi (1.4 to 6.2 bar)

### Models

- 1401: 0.25 gpm (0.06 m<sup>3</sup>/h; 0.9 l/m); full-circle, trickle pattern
- 1402: 0.50 gpm (0.11 m<sup>3</sup>/h; 1.8 l/m); full-circle, trickle pattern
- 1404: 1.00 gpm (0.23 m<sup>3</sup>/h; 3.6 l/m); full-circle, umbrella pattern
- 1408: 2.00 gpm (0.46 m<sup>3</sup>/h; 7.2 l/m); full-circle, umbrella pattern

\* These ranges are based on proper pressure at nozzle. Rain Bird recommends using 1800/RD1800 PRS Spray Bodies to maintain optimum nozzle performance in higher pressure situations.

## Pressure-Compensating Modules

Point-Source Medium-Flow Emitters for Watering Larger Shrubs and Trees



PCT-05, PCT-07, PCT-10

1/2" FPT inlet that easily threads onto a 1/2" PVC riser

### Operating Range

- Flow: 5, 7, 10 gph (18.93, 26.50, 37.95 l/h)
- Pressure: 10 to 50 psi (0.7 to 3.5 bar)
- Required filtration: 100 mesh (150 micron)

Refer to page 116 for more information

# Rotors

Introduction

Spray Bodies

Spray Nozzles

Rotors

Valves

Controllers

Central Controls

Landscape Drip

Pumps & Filtration

Drainage Products

Resources



*"Once my customers actually see the difference Rain Curtain nozzles make, they won't settle for anything but Rain Bird Rotors. They've really helped me build my business."*

**Dennis Hoffman**  
Grasshopper Irrigation, Inc.

Major Products	Closed Case Rotors				Open Case Rotor
	3504 Series	5000 Series	8005 Series	Falcon™ 6504 Series	2045A Maxi-Paw™ Series
<b>Primary Applications</b>					
Turfgrass 15' to 30'	●	●			
Turfgrass 25' to 50'		●	●	●	●
Turfgrass more than 50'			●	●	
Residential	●	●			●
Commercial		●	●	●	●
Vandalism/Damage Prone Areas			●		
Slopes	●	●	●	●	●
Ground Cover/Shrubs	●	●			
Athletic Fields			●	●	
Pressure Regulating		●			
High Wind Areas	●	●	●	●	●
Taller Turfgrass		●	●		
Non-Potable Water	●	●	●	●	●



## Water Saving Tips

- Rain Curtain™ nozzle technology is the standard in water-saving nozzle performance. Rain Curtain™ performance is available in all Rain Bird Rotors.
- 5000 Series Rotors with PRS reduce water waste from 15%-45%. By eliminating pressure variation and/or over pressurization, you'll save water and deliver greener results.
- All rotors with Seal-a-Matic™ (SAM) check valves prevent drainage from heads at lower elevations, stop water waste and eliminate landscape damage due to flooding and/or erosion.

## 3500 Series

Compact Residential Rotor. Big on Value and Convenience

### Features

- Rain Curtain™ nozzles deliver even distribution over the entire radius including large wind resistant droplets and gentle close-in watering resulting in greener turf using less water
- Oversized wiper seal prevents leaks and protects internals from debris
- Arc adjustment through the top of the rotor requiring only a flat-blade screwdriver
- 3 year trade warranty

### Operating Specifications

- Precipitation rate: 0.37 to 0.83 inches per hour (9 to 21 mm/h)
- Radius: 15 to 35 feet (4.6 to 10.7 m)
- Radius may be reduced up to 25% with radius reduction screw
- Pressure: 25 to 55 psi (1.7 to 3.8 bar)
- Flow rate: 0.54 to 4.6 gpm (2.0 to 17.4 l/m)
- ½" NPT female bottom threaded inlet
- Reversing full- and part-circle adjustment 40° - 360°

### Models

Part-circle units (PC) are adjustable from 40 -360 degrees.

- 3504-PC: 4" part/reverse full circle
- 3504-PC-SAM: 4" part/reverse full circle with SAM™
- 3504-PC-SAM-NP: 4" part/reverse full circle with SAM and NP cover
- 3500-S-SAM: 4" part/reverse full circle shrub model with SAM



3504-PC

-  0.37 to 0.83 in/hr  
(9 to 21 mm/h)

---

-  25 to 55 psi  
(1.7 to 3.8 bar)

---

-  0.54 to 4.6 gpm  
(2.0 to 17.4 l/m)  
(0.12 to 1.04 m³/h)

---

-  4" (10.2 cm)  
Shrub: 7" (17.8 cm)  
4": 6 5/8" (16.8 cm)  
½" (20/27) NPT

### How To Specify

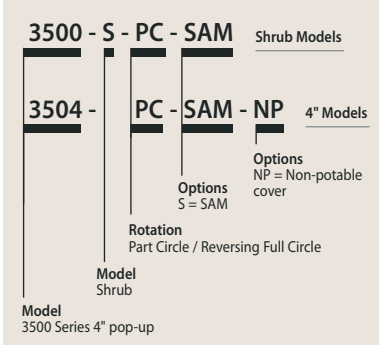

### Superior Distribution Uniformity

The 3500 Series Rotors with Rain Curtain Technology are engineered to deliver a uniform spray pattern, giving you a consistently green lawn throughout.

3504 Series Nozzle Performance					
Pressure psi	Nozzle	Radius ft.	Flow gpm	■ Precip In/h	▲ Precip In/h
25	0.75	15	0.54	0.46	0.53
	1.0	20	0.77	0.37	0.43
	1.5	23	1.06	0.39	0.45
	2.0	27	1.40	0.37	0.43
	3.0	29	2.17	0.50	0.57
	4.0	31	2.97	0.59	0.69
35	0.75	17	0.67	0.45	0.52
	1.0	21	0.92	0.40	0.46
	1.5	23	1.28	0.47	0.54
	2.0	27	1.69	0.45	0.52
	3.0	31	2.60	0.52	0.60
	4.0	33	3.58	0.63	0.73
45	0.75	17	0.77	0.51	0.59
	1.0	21	1.06	0.46	0.53
	1.5	24	1.48	0.49	0.57
	2.0	27	1.93	0.51	0.59
	3.0	31	3.00	0.60	0.69
	4.0	35	4.13	0.65	0.75
55	0.75	18	0.85	0.51	0.58
	1.0	22	1.18	0.47	0.54
	1.5	24	1.65	0.55	0.64
	2.0	28	2.15	0.53	0.61
	3.0	32	3.25	0.61	0.71
	4.0	35	4.60	0.72	0.83

Precipitation rates based on half-circle operation

■ Square spacing based on 50% diameter of throw

▲ Triangular spacing based on 50% diameter of throw

Performance data collected in zero wind conditions

Performance data derived from tests that conform with ASABE Standards; ASABE S398.1.

See page 186 for complete ASABE Test Certification Statement.

3504 Series Nozzle Performance					METRIC	
Pressure bar	Nozzle	Radius m	Flow m <sup>3</sup> /h	Flow l/m	■ Precip mm/h	▲ Precip mm/h
1.7	0.75	4.6	0.12	2.04	12	14
	1.0	6.1	0.17	2.91	9	11
	1.5	7.0	0.24	4.01	10	11
	2.0	8.2	0.32	5.30	9	11
	3.0	8.8	0.49	8.21	13	15
	4.0	9.4	0.67	11.24	15	17
2.0	0.75	4.8	0.13	2.24	12	13
	1.0	6.2	0.19	3.14	10	11
	1.5	7.0	0.26	4.35	11	12
	2.0	8.2	0.34	5.74	10	12
	3.0	9.1	0.53	8.87	13	15
	4.0	9.7	0.73	12.17	16	18
2.5	0.75	5.2	0.16	2.58	12	13
	1.0	6.4	0.21	3.55	10	12
	1.5	7.0	0.30	4.94	12	14
	2.0	8.2	0.39	6.51	12	13
	3.0	9.4	0.60	10.03	13	16
	4.0	10.1	0.83	13.82	16	19
3.0	0.75	5.2	0.17	2.86	13	15
	1.0	6.4	0.24	3.93	12	13
	1.5	7.3	0.33	5.49	12	14
	2.0	8.2	0.43	7.17	13	15
	3.0	9.4	0.67	11.13	15	17
	4.0	10.6	0.92	15.32	16	19
3.5	0.75	5.4	0.19	3.09	13	15
	1.0	6.6	0.26	4.27	12	14
	1.5	7.3	0.36	5.97	13	15
	2.0	8.4	0.47	7.79	13	15
	3.0	9.6	0.71	11.90	15	18
	4.0	10.7	1.00	16.66	18	20
3.8	0.75	5.5	0.19	3.22	13	15
	1.0	6.7	0.27	4.47	12	14
	1.5	7.3	0.37	6.25	14	16
	2.0	8.5	0.49	8.14	13	15
	3.0	9.8	0.74	12.30	16	18
	4.0	10.7	1.04	17.41	18	21

## 5000 Series

Engineered to be the Industry's Most Reliable and Best Performing Rotor

### Features

- Oversized wiper seal prevents leaks and protects internals from debris
- Rain Curtain™ nozzles deliver even distribution over the entire radius including large wind resistant droplets and gentle close-in watering resulting in greener turf using less water
- A history of proven performance and reliability tested in millions of installations
- Self-flushing arc adjustment port that prevents buildup of debris
- 5 year trade warranty

### Operating Specifications

- Precipitation rate: 0.20 to 1.01 in/hr (5 to 26 mm/h)
- Radius: 15 to 50 feet (4.6 to 15.2 m)
- Radius may be reduced up to 25% with radius reduction screw
- Pressure: 25 to 65 psi (1.7 to 4.5 bar)
- Flow Rate: 0.76 to 9.63 gpm (3.0 to 36.6 l/m; 0.17 to 2.19 m<sup>3</sup>/h)

### Optional Features

- All features of the 5000 Series plus:
  - **Plus (PL) Flow shutoff** – “The Green Top.” Reduce downtime on jobs by flushing and nozzling rotors without running back and forth to the controller or valves
  - **PRS (R)** with flow optimizer technology. The 45 psi pressure regulator lowers water bills, provides exact flow of each rotor, equalizes lateral lines, and eliminates misting and fogging
  - **SAM Seal-A-Matic** check valve
  - **Stainless steel (SS) riser** helps deter vandalism on public turf areas (available on 4 and 6" models)
  - **Purple cover (NP)** for non-potable systems



5000 Series

 0.20 to 1.01 in/hr  
(5 to 26 mm/h)

 25 to 65 psi  
(1.7 to 4.5 bar)

 0.76 to 9.63 gpm  
(3.0 to 36.6 l/m)  
(0.17 to 2.19 m<sup>3</sup>/h)

 Shrub: 4" (10.2 cm)  
6" (15.2 cm)  
12" (30.5 cm)  
Shrub: 7 3/4" (19.7cm)  
4": 7 3/8" (18.5 cm)  
6": 9 5/8" (24.5 cm)  
12": 16 7/8" (42.9 cm)  
3/4" (20/27) NPT

### How To Specify

**5004-+-S-PC-SAM-R-NP-SS**

Model	Options
5004: 4" pop-up	SAM
5006: 6" pop-up	R: PRS
5012: 12" pop-up	NP: Non-potable cover
	Rotation
	"PC" for 40°-360°
	"FC" for 360°
Model Plus (+)	Model Shrub
	Model Stainless steel

*Note: Certain specifications not available for some rotor series.*



Rotors

### 5000 Series (cont.)

- |   |                              |                           |
|---|------------------------------|---------------------------|
| <b>S</b> Shrub Model                          | <b>SAM</b> Check valve       | <b>SS</b> Stainless Steel |
| <b>+</b> Plus Model                           | <b>Plus</b> Flow shut-off    | <b>NP</b> Non-Potable ID  |
| <b>PC</b> Part Circle & Reversing Full Circle | <b>R</b> Pressure Regulation | <b>HS</b> High Speed      |
| <b>FC</b> Non-Reversing Full Circle           |                              |                           |

#### Models

Part-circle units (PC) are adjustable from 40 –350 degrees.  
Full-circle units (FC) are 360 degrees only.

- 5000SPCSAM: 5000S Shrub Part Circle SAM
- 5000+SPCSAM: 5000S Shrub Plus Part Circle SAM
- 5000+SPCSAMNP: 5000S Shrub Plus Part Circle SAM Non Potable
- 5000+SPCSAMR: 5000S Shrub Plus PRS Part Circle SAM
- 5000S+PCSR: 5000S Plus Shrub PRS PC SAM NP
- 5004PC: 5004 Part Circle
- 5004PC20: 5004 Part Circle w/2.0 Nozzle
- 5004PC30: 5004 Part Circle w/3.0 Nozzle
- 5004PCSAM: 5004 Part Circle SAM
- 5004PCSAM20: 5004 Part Circle SAM w/2.0 Nozzle
- 5004PCSAM30: 5004 Part Circle SAM w/3.0 Nozzle
- 5004PCNP: 5004 Part Circle Non Potable
- 5004PCR: 5004 Part Circle PRS
- 5004PCR20: 5004 Part Circle PRS w/ 2.0 Nozzle
- 5004PCR30: 5004 Part Circle PRS w/ 3.0 Nozzle
- 5004+PC: 5004 Plus Part Circle
- 5004+PC20: 5004 Plus Part Circle w/2.0 Nozzle
- 5004+PC30: 5004 Plus Part Circle w/3.0 Nozzle
- 5004+PCSAM: 5004 Plus Part Circle SAM
- 5004+PCR 5004: Plus Part Circle PRS
- 5004+PCSAMR: 5004 Plus Part Circle SAM PRS
- 5004+PCSAMR20: 5004 Plus Part Circle SAM PRS w/2.0 Nozzle
- 5004+PCSAMR30: 5004 Plus Part Circle SAM PRS w/3.0 Nozzle
- 5004+PCSAMRNP: 5004 Plus Part Circle SAM PRS Non Potable
- 5004+PCSAMRSS: 5004 Plus Part Circle SAM PRS Stainless Steel
- 5004+PCSAMRNS: 5004 Plus Part Circle SAM PRS Stainless Steel Non Potable
- 5004FC 5004: Full Circle
- 5004+FC 5004: Plus Full Circle
- 5004+FCSAM: 5004 Plus Full Circle SAM
- 5004+FCSAMR: 5004 Plus Full Circle SAM PRS
- 5004+FCSAMRSS: 5004 Plus Full Circle Stainless Steel SAM PRS
- 5006PC: 5006 Part Circle
- 5006PC30: 5006 Part Circle w/ 3.0 Nozzle
- 5006+PC: 5006 Plus Part Circle
- 5006+PCSAM: 5006 Plus Part Circle SAM
- 5006+PCSAMNP: 5006 Plus Part Circle SAM Non Potable
- 5006+PCSAMR: 5006 Plus Part Circle SAM PRS
- 5006+PCSAMRNP: 5006 Plus Part Circle SAM PRS Non Potable
- 5006+PCSAMRSS: 5006 Plus Part Circle SAM PRS Stainless Steel
- 5006+PCSAMRNS: 5006 Plus Part Circle SAM PRS Stainless Steel Non Potable
- 5012+PCSAMR: 5012 Plus Part Circle SAM PRS
- 5012+PCSAMRNP: 5012 Plus Part Circle SAM PRS Non Potable
- 5000S+PCSR: 5000S PLUS SHRUB PRS PC SAM NP

Rotors

### Three steps to specification:

1. Choose your rotor model and size.
2. Choose arc setting PC/FC.
3. Add available options or pre-installed nozzles.

	Model/Size (Choose 1)	Part or Full Circle (Choose 1)	Available Options (Optional Choices)	Pre-Installed nozzles (Optional Choices)	Specification Notes
<b>Closed Case Rotors</b>	3500S 3504	PC	SAM NP		Part circle / reversing full circle
	5000S 5000+S 5004 5004+ 5006 5006+ 5012 5012+	PC FC	SAM R SS NP	20 30	PC only on 5000, 5006 and 5012 models. 2.0 or 3.0 nozzles.
	6504	PC FC	SS NP HS		SAM standard.
	8005		SS NP		Part circle and non-reversing full circle in one head. SAM standard.
	<b>Open Case Rotors</b>	Maxi-Paw		SAM NP	



5000 Series Std. Angle Rain Curtain™ Nozzle Performance					
Pressure psi	Nozzle	Radius ft.	Flow gpm	■ Precip In/h	▲ Precip In/h
25	1.5	33	1.12	0.20	0.23
	2.0	35	1.50	0.24	0.27
	2.5	35	1.81	0.28	0.33
	3.0	36	2.26	0.34	0.39
	4.0	36	2.91	0.43	0.49
	5.0	37	3.72	0.52	0.60
	6.0	37	4.25	0.60	0.69
	8.0	30	5.90	1.26	1.50
35	1.5	34	1.35	0.22	0.26
	2.0	36	1.81	0.27	0.31
	2.5	37	2.17	0.31	0.35
	3.0	38	2.71	0.36	0.42
	4.0	40	3.50	0.42	0.49
	5.0	41	4.47	0.51	0.59
	6.0	43	5.23	0.54	0.63
	8.0	38	7.06	0.94	1.10
45	1.5	35	1.54	0.24	0.28
	2.0	37	2.07	0.29	0.34
	2.5	37	2.51	0.35	0.41
	3.0	39	3.09	0.37	0.43
	4.0	42	4.01	0.44	0.51
	5.0	43	5.09	0.48	0.56
	6.0	44	6.01	0.59	0.69
	8.0	41	8.03	0.92	1.06
55	1.5	35	1.71	0.27	0.31
	2.0	37	2.30	0.32	0.37
	2.5	37	2.76	0.39	0.45
	3.0	40	3.47	0.42	0.48
	4.0	42	4.44	0.48	0.56
	5.0	45	5.66	0.54	0.62
	6.0	50	6.63	0.51	0.59
	8.0	46	8.86	0.80	0.93
65	1.5	34	1.86	0.31	0.36
	2.0	35	2.52	0.40	0.46
	2.5	37	3.01	0.42	0.49
	3.0	40	3.78	0.45	0.53
	4.0	42	4.83	0.53	0.61
	5.0	45	6.16	0.59	0.68
	6.0	50	7.22	0.55	0.64
	8.0	47	9.63	0.84	0.97

Precipitation rates based on half-circle operation

■ Square spacing based on 50% diameter of throw

▲ Triangular spacing based on 50% diameter of throw

Performance data collected in zero wind conditions

Performance data derived from tests that conform with ASABE Standards; ASABE S398.1. See page 186 for complete ASABE Test Certification Statement.

5000 Series Std. Angle Rain Curtain™ Nozzle Performance						
Pressure bar	Nozzle	Radius m	Flow m <sup>3</sup> /h	Flow l/m	■ Precip mm/h	▲ Precip mm/h
2.0	1.5	10.2	0.28	4.8	5	6
	2.0	10.8	0.36	6.0	6	7
	2.5	10.9	0.44	7.2	7	9
	3.0	11.2	0.55	9.0	9	10
	4.0	11.6	0.71	12.0	11	12
	5.0	12.1	0.91	15.0	13	15
	6.0	12.4	1.05	17.4	15	17
	8.0	11.8	1.45	24.0	32	37
2.5	1.5	10.4	0.31	5.4	6	7
	2.0	11.0	0.41	6.6	7	8
	2.5	11.3	0.50	8.4	8	9
	3.0	11.2	0.62	10.2	9	11
	4.0	12.3	0.81	13.2	11	13
	5.0	12.7	1.03	17.4	13	15
	6.0	13.2	1.21	20.4	14	16
	8.0	13.3	1.63	27.0	24	28
3.0	1.5	10.6	0.34	6.0	6	7
	2.0	11.2	0.45	7.8	7	8
	2.5	11.3	0.56	9.6	9	10
	3.0	12.1	0.69	11.4	9	11
	4.0	12.7	0.89	15.0	11	13
	5.0	13.5	1.13	18.6	12	14
	6.0	13.4	1.34	22.2	13	17
	8.0	13.4	1.79	30.0	23	27
3.5	1.5	10.7	0.37	6.0	7	8
	2.0	11.3	0.49	8.4	8	9
	2.5	11.3	0.60	10.2	9	11
	3.0	12.2	0.74	12.6	10	12
	4.0	12.8	0.97	16.2	12	14
	5.0	13.7	1.23	20.4	13	15
	6.0	14.2	1.45	24.0	13	15
	8.0	14.9	1.93	32.4	20	24
4.0	1.5	10.6	0.40	6.6	7	8
	2.0	11.1	0.52	9.0	8	10
	2.5	11.3	0.64	10.8	10	12
	3.0	12.2	0.80	13.2	11	12
	4.0	12.8	1.04	17.4	13	15
	5.0	13.7	1.32	22.2	14	16
	6.0	14.9	1.55	25.8	14	16
	8.0	15.2	2.06	34.2	21	25
4.5	1.5	10.4	0.42	7.2	8	9
	2.0	10.7	0.55	9.0	10	11
	2.5	11.3	0.68	11.4	11	12
	3.0	12.2	0.84	13.8	11	13
	4.0	12.8	1.10	18.0	13	15
	5.0	13.7	1.40	23.4	15	17
	6.0	14.6	1.64	28.2	15	18
	8.0	15.2	2.19	36.6	19	22

Rotors

5000 Series Low Angle Nozzle Performance					
Pressure psi	Nozzle	Radius ft.	Flow gpm	■ Precip In/h	▲ Precip In/h
25	1.0 LA	25	0.76	0.23	0.27
	1.5 LA	27	1.15	0.30	0.35
	2.0 LA	29	1.47	0.34	0.39
	3.0 LA	29	2.23	0.51	0.59
35	1.0 LA	28	0.92	0.23	0.26
	1.5 LA	30	1.38	0.30	0.34
	2.0 LA	31	1.77	0.35	0.41
	3.0 LA	33	2.68	0.47	0.55
45	1.0 LA	27	1.05	0.27	0.32
	1.5 LA	28	1.58	0.38	0.45
	2.0 LA	29	2.02	0.46	0.53
	3.0 LA	32	3.07	0.57	0.67
55	1.0 LA	29	1.17	0.27	0.31
	1.5 LA	31	1.76	0.35	0.41
	2.0 LA	33	2.24	0.40	0.46
	3.0 LA	36	3.41	0.51	0.58
65	1.0 LA	29	1.27	0.29	0.34
	1.5 LA	31	1.92	0.38	0.44
	2.0 LA	33	2.45	0.43	0.50
	3.0 LA	36	3.72	0.55	0.64

5000 Series Low Angle Nozzle Performance						METRIC	
Pressure bar	Nozzle	Radius m	Flow m <sup>3</sup> /h	Flow l/m	■ Precip mm/h	▲ Precip mm/h	
1.7	1.0 LA	7.6	0.17	3.0	6	7	
	1.5 LA	8.2	0.26	4.2	8	9	
	2.0 LA	8.8	0.33	5.4	9	10	
	3.0 LA	8.8	0.51	8.4	13	15	
2.0	1.0 LA	8.0	0.18	3.0	6	6	
	1.5 LA	8.6	0.28	4.8	8	9	
	2.0 LA	9.1	0.36	6.0	9	10	
	3.0 LA	9.3	0.55	9.0	13	15	
2.5	1.0 LA	8.2	0.20	3.6	6	8	
	1.5 LA	8.5	0.32	5.4	9	11	
	2.0 LA	8.8	0.41	6.6	11	13	
	3.0 LA	9.7	0.62	10.2	14	17	
3.0	1.0 LA	8.8	0.22	3.6	6	7	
	1.5 LA	9.4	0.35	6.0	8	9	
	2.0 LA	9.7	0.45	7.8	10	11	
	3.0 LA	10.6	0.68	11.4	12	14	
3.5	1.0 LA	8.8	0.24	4.2	6	7	
	1.5 LA	9.4	0.38	6.6	9	10	
	2.0 LA	9.9	0.49	8.4	10	11	
	3.0 LA	10.8	0.74	12.6	13	15	
4.0	1.0 LA	8.8	0.26	4.2	7	8	
	1.5 LA	9.4	0.41	6.6	9	11	
	2.0 LA	10.1	0.52	9.0	10	12	
	3.0 LA	11.0	0.80	13.2	13	15	
4.5	1.0 LA	8.8	0.27	4.8	7	8	
	1.5 LA	9.4	0.44	7.2	10	11	
	2.0 LA	10.1	0.56	9.0	11	13	
	3.0 LA	11.0	0.84	13.8	14	16	

Precipitation rates based on half-circle operation

■ Square spacing based on 50% diameter of throw

▲ Triangular spacing based on 50% diameter of throw

Performance data collected in zero wind conditions

Performance data derived from tests that conform with ASABE Standards; ASABE S398.1.

See page 186 for complete ASABE Test Certification Statement.

## Holdup Tool with Bubble Level

### Features

- Combination holdup tool/ bubble level makes proper installation easier
- Works with 5000, 5500, Falcon® 6504, and 8005



HOLDUPTOOL

## ROTORTOOL

### Features

- Flat blade screwdriver and pull-up tool all in one

### Model

- ROTORTOOL



ROTORTOOL

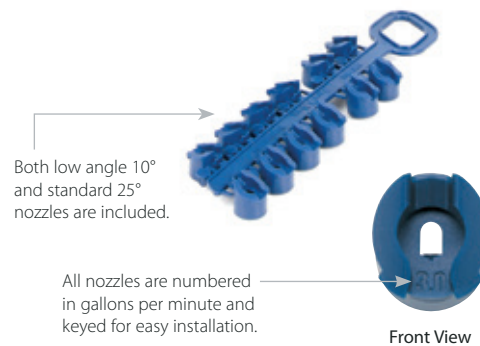

5000 PRS Std. Angle Rain Curtain™ Nozzle Performance					
Pressure psi	Nozzle	Radius ft.	Flow gpm	■ Precip In/h	▲ Precip In/h
25	1.5	33	1.12	0.2	0.23
	2.0	35	1.5	0.24	0.27
	2.5	35	1.81	0.28	0.33
	3.0	36	2.26	0.34	0.39
	4.0	36	2.91	0.43	0.49
	5.0	37	3.72	0.52	0.66
	6.0	37	4.25	0.60	0.69
	8.0	30	5.9	1.26	1.5
35	1.5	34	1.35	0.22	0.26
	2.0	36	1.81	0.27	0.31
	2.5	37	2.17	0.31	0.35
	3.0	38	2.71	0.36	0.41
	4.0	40	3.5	0.42	0.49
	5.0	41	4.47	0.51	0.59
	6.0	43	5.23	0.54	0.63
	8.0	38	7.06	0.94	1.1
45	1.5	35	1.54	0.24	0.28
	2.0	37	2.07	0.29	0.34
	2.5	37	2.51	0.35	0.41
	3.0	40	3.09	0.37	0.43
	4.0	42	4.01	0.44	0.51
	5.0	45	5.09	0.48	0.56
	6.0	46	6.01	0.55	0.63
	8.0	41	8.03	0.92	1.06
55 – 75	1.5	35	1.59	0.25	0.29
	2.0	37	2.14	0.3	0.35
	2.5	37	2.6	0.37	0.42
	3.0	40	3.2	0.39	0.44
	4.0	42	4.15	0.45	0.52
	5.0	45	5.27	0.5	0.58
	6.0	46	6.22	0.57	0.65
	8.0	47	8.31	0.72	0.84

Precipitation rates based on half-circle operation

■ Square spacing based on 50% diameter of throw

▲ Triangular spacing based on 50% diameter of throw

Performance data collected in zero wind conditions

Performance data derived from tests that conform with ASABE Standards; ASABE S398.1.

See page 186 for complete ASABE Test Certification Statement.

5000 PRS Std. Angle Rain Curtain™ Nozzle Performance						METRIC
Pressure bar	Nozzle	Radius m	Flow m <sup>3</sup> /h	Flow l/m	■ Precip mm/h	▲ Precip mm/h
1.7	1.5	10.1	0.25	4.2	5	6
	2.0	10.7	0.34	5.4	6	7
	2.5	10.7	0.41	6.6	7	8
	3.0	11.0	0.51	8.4	8	10
	4.0	11.3	0.66	10.8	10	12
	5.0	11.9	0.84	13.8	12	14
	6.0	11.9	0.97	16.2	14	16
	8.0	11.0	1.34	22.2	22	26
2.0	1.5	10.2	0.28	4.8	5	6
	2.0	10.8	0.36	6.0	6	7
	2.5	10.9	0.44	7.2	7	9
	3.0	11.2	0.55	9.0	9	10
	4.0	11.6	0.71	12.0	11	12.6
	5.0	12.1	0.91	15.0	13	15
	6.0	12.4	1.05	17.4	15	17
	8.0	11.8	1.45	24.0	32	37
2.5	1.5	10.4	0.31	5.4	6	7
	2.0	11.0	0.41	6.6	7	8
	2.5	11.3	0.50	8.4	8	9
	3.0	11.2	0.62	10.2	9	11
	4.0	12.3	0.81	13.2	11	13
	5.0	12.7	1.03	17.4	13	15
	6.0	13.2	1.21	20.4	14	16
	8.0	13.3	1.63	27.0	24	18
3.0	1.5	10.6	0.34	6.0	6	7
	2.0	11.2	0.45	7.8	7	8
	2.5	11.3	0.56	9.6	9	10
	3.0	12.1	0.69	11.4	9	11
	4.0	12.7	0.89	16.8	11	13
	5.0	13.5	1.13	18.6	12	14
	6.0	13.9	1.34	22.2	14	16
	8.0	14.1	1.79	30.0	23	27
3.5 – 5.2	1.5	10.6	0.35	6.0	6	7
	2.0	11.2	0.47	7.8	8	9
	2.5	11.3	0.58	10.2	9	11
	3.0	12.1	0.71	12.0	10	11
	4.0	12.7	0.92	15.6	12	13
	5.0	13.5	1.17	19.2	13	15
	6.0	13.9	1.39	22.8	14	17
	8.0	14.1	1.85	31.2	18	21

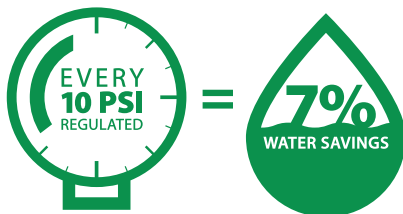

5000 PRS Low Angle Nozzle Performance					
Pressure psi	Nozzle	Radius ft.	Flow gpm	■ Precip In/h	▲ Precip In/h
25	1.0 LA	25	0.76	0.22	0.26
	1.5 LA	27	1.15	0.3	0.35
	2.0 LA	29	1.47	0.34	0.39
	3.0 LA	29	2.23	0.51	0.59
35	1.0 LA	28	0.92	0.21	0.25
	1.5 LA	30	1.38	0.3	0.34
	2.0 LA	31	1.77	0.35	0.41
	3.0 LA	33	2.68	0.47	0.55
45	1.0 LA	29	1.05	0.23	0.26
	1.5 LA	31	1.58	0.32	0.37
	2.0 LA	32	2.02	0.38	0.44
	3.0 LA	35	3.07	0.48	0.56
55 - 75	1.0 LA	29	1.09	0.25	0.29
	1.5 LA	31	1.64	0.33	0.38
	2.0 LA	32	2.09	0.39	0.45
	3.0 LA	35	3.18	0.5	0.58

5000 PRS Low Angle Nozzle Performance					METRIC	
Pressure bar	Nozzle	Radius m	Flow m <sup>3</sup> /h	Flow l/m	■ Precip mm/h	▲ Precip mm/h
1.7	1.0 LA	7.6	0.17	3.0	6	7
	1.5 LA	8.2	0.26	4.2	8	9
	2.0 LA	8.8	0.33	5.4	9	10
	3.0 LA	8.8	0.51	8.4	13	15
2.0	1.0 LA	8.0	0.18	3.0	6	6
	1.5 LA	8.6	0.28	4.8	8	9
	2.0 LA	9.1	0.36	6.0	9	10
	3.0 LA	9.3	0.55	9.0	13	15
2.5	1.0 LA	8.6	0.20	3.6	5	6
	1.5 LA	9.2	0.32	5.4	8	9
	2.0 LA	9.5	0.41	6.6	9	10
	3.0 LA	10.1	0.62	10.2	12	14
3.0	1.0 LA	8.8	0.22	3.6	6	7
	1.5 LA	9.4	0.35	6.0	8	9
	2.0 LA	9.7	0.45	7.8	10	11
	3.0 LA	10.6	0.68	11.4	12	14
3.5 - 5.2	1.0 LA	8.8	0.23	3.6	6	7
	1.5 LA	9.4	0.36	6.0	8	10
	2.0 LA	9.7	0.47	7.8	10	12
	3.0 LA	10.6	0.70	12.0	13	15

Precipitation rates based on half-circle operation

■ Square spacing based on 50% diameter of throw

▲ Triangular spacing based on 50% diameter of throw

Performance data collected in zero wind conditions

Performance data derived from tests that conform with ASABE Standards; ASABE S398.1.

See page 186 for complete ASABE Test Certification Statement.

### Flow Rate vs. Inlet Pressure – Rain Curtain™ Nozzles

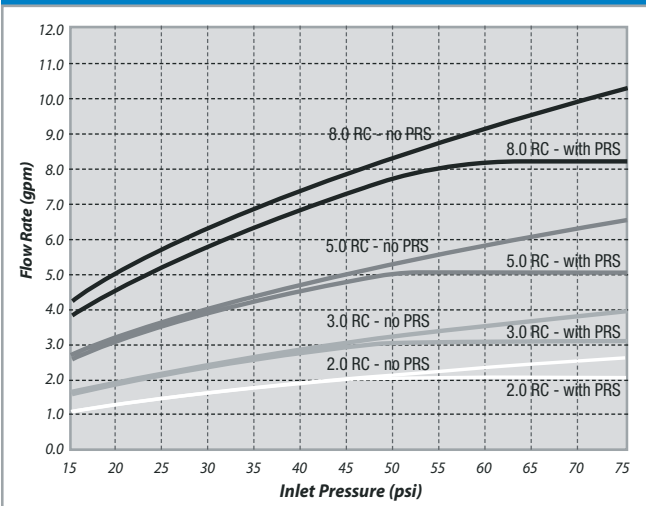

### How much water can you save each minute using Rain Bird® 5000 PRS Rotors with Flow Optimizer Technology?

Flow GPM	45	50	55	60	65	70	75	80
6	0	0.33	0.66	0.96	1.25	1.54	1.81	2.06
8	0	0.43	0.85	1.24	1.62	1.98	2.33	2.67
10	0	0.55	1.07	1.57	2.05	2.52	2.96	3.39
12	0	0.66	1.27	1.86	2.43	2.97	3.50	4.01
14	0	0.77	1.49	2.18	2.84	3.48	4.10	4.70
16	0	0.87	1.69	2.48	3.24	3.97	4.67	5.35
18	0	0.98	1.90	2.79	3.64	4.46	5.25	6.01
20	0	1.10	2.12	3.10	4.05	4.96	5.83	6.68
22	0	1.21	2.33	3.42	4.46	5.47	6.44	7.37
24	0	1.30	2.54	3.72	4.85	5.94	7.00	8.01
26	0	1.41	2.76	4.04	5.27	6.45	7.60	8.70
28	0	1.53	2.96	4.34	5.66	6.93	8.16	9.35
30	0	1.63	3.17	4.65	6.07	7.43	8.74	10.02

**Total gallons of water saved per minute of run time**

**Ex: At 70 psi a zone with 20 gpm of flow would save 4.96 gallons a minute with 5000 PRS**

## 5000 Series MPR Nozzles

Perfectly Balanced Coverage with the 5000 Series Rotor

### Features

- Rain Curtain™ nozzles deliver even distribution over the entire radius including large wind resistant droplets and gentle close-in watering resulting in greener turf using less water
- Precipitation rate is automatically matched with a uniform radius that does not require stream deflection
- Matched 0.6"/hour precipitation rates enable large and small turf areas to be zoned together by mixing rotors and Rain Bird R-VAN or R-Series rotary nozzles





### Models



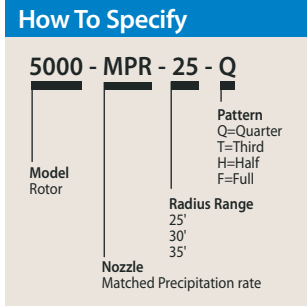

- 5000MPRMPK: 5000/5000 Plus Series MPR nozzle tree multi pack- 25', 30', 35' radius in Quarter, Third, Half, Full arc











5000 Series MPR Nozzles











5000-MPR-25 (Red)						
Nozzle	Pressure psi	Radius ft.	Flow gpm	Precip In/h	Precip In/h	
Quarter 	25	23	0.74	0.54	0.62	
	35	24	0.88	0.59	0.68	
	45	25	1.00	0.62	0.71	
	55	25	1.11	0.68	0.79	
	65	25	1.21	0.75	0.86	
Third 	25	23	1.00	0.55	0.63	
	35	24	1.21	0.61	0.70	
	45	25	1.38	0.64	0.74	
	55	25	1.53	0.71	0.82	
	65	25	1.67	0.77	0.89	
Half 	25	23	1.44	0.52	0.61	
	35	24	1.73	0.58	0.67	
	45	25	1.98	0.61	0.70	
	55	25	2.21	0.68	0.79	
	65	25	2.41	0.74	0.86	
Full 	25	23	2.78	0.51	0.58	
	35	24	3.34	0.56	0.64	
	45	25	3.82	0.59	0.68	
	55	25	4.25	0.65	0.76	
	65	25	4.63	0.71	0.82	

5000-MPR-25 (Red) METRIC						
Nozzle	Pressure bar	Radius m	Flow m <sup>3</sup> /h	Flow l/m	Precip mm/h	Precip mm/h
Quarter 	1.7	7.0	0.17	3.0	13.7	15.8
	2.4	7.3	0.20	3.6	14.9	17.3
	3.1	7.6	0.23	3.6	15.6	18.1
	3.8	7.6	0.25	4.2	17.4	20.1
	4.5	7.6	0.27	4.8	18.9	21.9
Third 	1.7	7.0	0.23	3.6	13.9	16.0
	2.4	7.3	0.27	4.8	15.4	17.8
	3.1	7.6	0.31	5.4	16.2	18.7
	3.8	7.6	0.35	6.0	18.0	20.7
	4.5	7.6	0.38	6.6	19.6	22.6
Half 	1.7	7.0	0.33	5.4	13.3	15.4
	2.4	7.3	0.39	6.6	14.7	17.0
	3.1	7.6	0.45	7.2	15.5	17.9
	3.8	7.6	0.50	8.4	17.3	20.0
	4.5	7.6	0.55	9.0	18.9	21.8
Full 	1.7	7.0	0.63	10.8	12.8	14.8
	2.4	7.3	0.76	12.6	14.2	16.4
	3.1	7.6	0.87	14.4	14.9	17.3
	3.8	7.6	0.97	16.2	16.6	19.2
	4.5	7.6	1.05	17.4	18.1	20.9

5000-MPR-30 (Green)					
Nozzle	Pressure psi	Radius ft.	Flow gpm	■ Precip In/h	▲ Precip In/h
 Quarter	25	29	1.03	0.47	0.54
	35	30	1.23	0.53	0.61
	45	30	1.40	0.60	0.69
	55	30	1.56	0.67	0.77
	65	30	1.69	0.72	0.83
 Third	25	29	1.34	0.46	0.53
	35	30	1.62	0.52	0.60
	45	30	1.85	0.59	0.69
	55	30	2.06	0.66	0.76
	65	30	2.24	0.72	0.83
 Half	25	29	2.15	0.49	0.57
	35	30	2.59	0.55	0.64
	45	30	2.96	0.63	0.73
	55	30	3.30	0.71	0.82
	65	30	3.60	0.77	0.89
 Full	25	29	4.24	0.49	0.56
	35	30	5.08	0.54	0.63
	45	30	5.78	0.62	0.71
	55	30	6.39	0.68	0.79
	65	30	6.92	0.74	0.85

5000-MPR-30 (Green)					METRIC	
Nozzle	Pressure bar	Radius m	Flow m <sup>3</sup> /h	Flow l/m	■ Precip mm/h	▲ Precip mm/h
 Quarter	1.7	8.8	0.23	3.6	12.0	13.8
	2.4	9.1	0.28	4.8	13.4	15.4
	3.1	9.1	0.32	5.4	15.2	17.6
	3.8	9.1	0.35	6.0	17.0	19.6
	4.5	9.1	0.38	6.6	18.4	21.2
 Third	1.7	8.8	0.30	4.8	11.7	13.5
	2.4	9.1	0.37	6.0	13.2	15.2
	3.1	9.1	0.42	7.2	15.1	17.4
	3.8	9.1	0.47	7.8	16.8	19.4
	4.5	9.1	0.51	8.4	18.3	21.1
 Half	1.7	8.8	0.49	8.4	12.5	14.4
	2.4	9.1	0.59	9.6	14.1	16.2
	3.1	9.1	0.67	11.4	16.1	18.6
	3.8	9.1	0.75	12.6	17.9	20.7
	4.5	9.1	0.82	13.8	19.6	22.6
 Full	1.7	8.8	0.96	16.2	12.3	14.2
	2.4	9.1	1.15	19.2	13.8	15.9
	3.1	9.1	1.31	21.6	15.7	18.1
	3.8	9.1	1.45	24.0	17.4	20.0
	4.5	9.1	1.57	26.4	18.8	21.7

5000-MPR-35 (Beige)					
Nozzle	Pressure psi	Radius ft.	Flow gpm	■ Precip In/h	▲ Precip In/h
 Quarter	25	32	1.40	0.53	0.61
	35	34	1.67	0.56	0.64
	45	35	1.92	0.60	0.70
	55	35	2.13	0.67	0.77
	65	35	2.31	0.73	0.84
 Third	25	32	1.77	0.50	0.58
	35	34	2.15	0.54	0.62
	45	35	2.46	0.58	0.67
	55	35	2.74	0.65	0.75
	65	35	2.99	0.70	0.81
 Half	25	32	2.75	0.52	0.60
	35	34	3.33	0.55	0.64
	45	35	3.81	0.60	0.69
	55	35	4.23	0.66	0.77
	65	35	4.62	0.73	0.84
 Full	25	32	5.36	0.50	0.58
	35	34	6.62	0.55	0.64
	45	35	7.58	0.60	0.69
	55	35	8.43	0.66	0.76
	65	35	9.18	0.72	0.83

5000-MPR-35 (Beige)					METRIC	
Nozzle	Pressure bar	Radius m	Flow m <sup>3</sup> /h	Flow l/m	■ Precip mm/h	▲ Precip mm/h
 Quarter	1.7	9.8	0.32	5.4	13.4	15.4
	2.4	10.4	0.38	6.6	14.1	16.3
	3.1	10.7	0.44	7.2	15.3	17.7
	3.8	10.7	0.48	7.8	17.0	19.6
	4.5	10.7	0.52	9.0	18.4	21.3
 Third	1.7	9.8	0.40	6.6	12.7	14.6
	2.4	10.4	0.49	8.4	13.6	15.8
	3.1	10.7	0.56	9.6	14.7	17.0
	3.8	10.7	0.62	10.2	16.4	18.9
	4.5	10.7	0.68	11.4	17.9	20.7
 Half	1.7	9.8	0.62	10.2	13.1	15.2
	2.4	10.4	0.76	12.6	14.1	16.3
	3.1	10.7	0.87	14.4	15.2	17.6
	3.8	10.7	0.96	16.2	16.9	19.5
	4.5	10.7	1.05	17.4	18.4	21.3
 Full	1.7	9.8	1.22	20.4	12.8	14.8
	2.4	10.4	1.50	25.2	14.0	16.2
	3.1	10.7	1.72	28.8	15.1	17.5
	3.8	10.7	1.91	31.8	16.8	19.4
	4.5	10.7	2.09	34.8	18.3	21.2

■ Square spacing based on 50% diameter of throw  
▲ Triangular spacing based on 50% diameter of throw  
Performance data collected in zero wind conditions

Performance data derived from tests that conform with ASABE Standards; ASABE S398.1.  
See page 186 for complete ASABE Test Certification Statement.

## Falcon® 6504 Series

Reliable and Economical

### Features

- Ratcheting stem just like standard spray bodies
- 3-port, color-coded Rain Curtain nozzles for optimal long range, mid-range, and close-in watering
- SAM Seal-A-Matic check valve
- Self-adjusting stator does not require replacement when changing nozzles
- Heavy-duty, stainless steel retract spring ensures positive pop down
- 5 year warranty

### Options

- **Stainless steel (SS)** riser helps deter vandalism on public turf areas
- **Purple cover (NP)** for non-potable systems
- **High Speed (HS)** "Tan Top" version for dust suppression

### Operating Specifications

- Precipitation rate: 0.37 to 1.14 inches per hour (9 to 29 mm/h)
- Radius: 39 to 65 feet (11.9 to 19.8 m)
- Pressure: 30 to 90 psi (2.1 to 6.2 bar)
- Flow: 2.9 to 21.7 gpm (0.66 to 4.93 m<sup>3</sup>/h; 10.8 to 82.2 l/m)
- 1" (26/34) female NPT or BSP threaded inlet
- SAM check device holds up to 10 feet (3.1 m) of elevation change
- Rain Curtain™ Nozzles: 04-black; 06-light blue; 08-dark green; 10-grey; 12-beige; 14-light green; 16-dark brown; 18-dark blue

### Models

- F4-FC: Full-circle
- F4-PC: Part-circle
- F4-FC-NP: Full-circle, non-potable cover
- F4-PC-NP: Part-circle, non-potable cover
- F4-FC-SS: Full-circle, stainless steel
- F4-PC-SS: Part-circle, stainless steel
- F4-FC-SS-HS: Full-circle, stainless steel, high speed rotation
- F4-PC-SS-HS: Part-circle, stainless steel, high speed rotation
- F4-FC-SS-NP: Full-circle, stainless steel, non-potable cover
- F4-PC-SS-NP: Part-circle, stainless steel, non-potable cover

*Note: All models available with BSP threads*



Falcon® 6504 Series

 0.37 to 1.14 in/hr  
(9 to 29 mm/h)

 30 to 90 psi  
(2.1 to 6.2 bar)

 2.9 to 21.7 gpm  
(10.8 to 82.2 l/m)  
(0.66 to 4.93 m<sup>3</sup>/h)

 4" (10.2 cm)  
8½" (21.6 cm)  
1" (26/34) NPT or BSP

### How To Specify

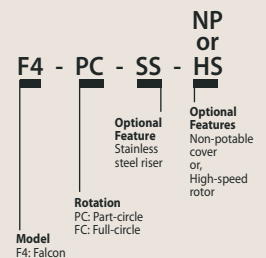

*Note: For non-U.S. applications, it is necessary to specify NPT or BSP thread type.*



Falcon® 6504 Nozzle Performance					
Pressure psi	Nozzle	Radius ft.	Flow gpm	■ Precip In/h	▲ Precip In/h
30	● 4	39	2.9	0.37	0.42
	● 6	43	4.2	0.44	0.50
40	● 4	41	3.3	0.38	0.44
	● 6	45	4.9	0.47	0.54
	● 8	49	6.6	0.53	0.61
	● 10	51	8.1	0.60	0.69
	● 12	53	9.7	0.66	0.77
	● 14	55	11.3	0.72	0.83
	● 16	55	12.6	0.80	0.93
	● 18	59	13.7	0.76	0.87
50	● 4	41	3.7	0.42	0.49
	● 6	47	5.5	0.44	0.51
	● 8	51	7.4	0.55	0.63
	● 10	53	9.1	0.62	0.72
	● 12	55	11.0	0.70	0.81
	● 14	59	12.7	0.70	0.81
	● 16	61	14.3	0.74	0.85
	● 18	59	15.4	0.85	0.98
60	● 4	41	4.0	0.46	0.53
	● 6	47	6.0	0.52	0.60
	● 8	51	8.2	0.61	0.70
	● 10	55	10.0	0.64	0.73
	● 12	57	12.2	0.72	0.83
	● 14	61	14.0	0.72	0.84
	● 16	63	15.7	0.76	0.88
	● 18	63	17.1	0.83	0.96
70	● 4	41	4.4	0.50	0.58
	● 6	49	6.3	0.51	0.58
	● 8	51	8.9	0.66	0.76
	● 10	57	10.8	0.64	0.74
	● 12	59	13.2	0.73	0.84
	● 14	61	15.2	0.79	0.91
	● 16	63	16.9	0.82	0.95
	● 18	65	18.3	0.83	0.96
80	● 4	43	4.6	0.48	0.55
	● 6	49	6.9	0.55	0.64
	● 8	53	9.4	0.64	0.74
	● 10	55	11.6	0.74	0.85
	● 12	61	14.0	0.72	0.84
	● 14	61	16.2	0.84	0.97
	● 16	63	18.1	0.88	1.01
	● 18	65	19.6	0.89	1.03
90	● 18	65	21.7	0.99	1.14

High-Speed Falcon® 6504 Nozzle Performance					
Pressure psi	Nozzle	Radius ft.	Flow gpm	■ Precip In/h	▲ Precip In/h
30	● 4	37	3.0	0.42	0.49
	● 6	39	4.3	0.54	0.63
40	● 4	41	3.5	0.40	0.46
	● 6	43	6.0	0.62	0.72
	● 8	47	6.6	0.58	0.66
	● 10	47	8.1	0.71	0.82
	● 12	49	9.9	0.79	0.92
	● 14	53	11.4	0.78	0.90
	● 16	51	12.6	0.93	1.08
	● 18	53	13.9	0.95	1.10
50	● 4	41	3.7	0.42	0.49
	● 6	45	5.6	0.53	0.62
	● 8	49	7.5	0.60	0.69
	● 10	49	9.2	0.74	0.85
	● 12	53	11.2	0.77	0.89
	● 14	53	12.9	0.88	1.02
	● 16	53	14.3	0.98	1.13
	● 18	55	15.6	0.99	1.15
60	● 4	41	4.2	0.48	0.56
	● 6	45	6.2	0.59	0.68
	● 8	47	8.3	0.72	0.84
	● 10	49	10.2	0.82	0.94
	● 12	53	12.4	0.85	0.98
	● 14	53	14.2	0.97	1.12
	● 16	55	15.7	1.00	1.15
	● 18	59	17.2	0.95	1.10
70	● 4	41	4.6	0.53	0.61
	● 6	43	6.7	0.70	0.81
	● 8	49	9.0	0.72	0.83
	● 10	51	11.1	0.82	0.95
	● 12	55	13.5	0.86	0.99
	● 14	53	15.3	1.05	1.21
	● 16	57	17.1	1.01	1.17
	● 18	59	18.6	1.03	1.19
80	● 4	39	4.9	0.62	0.72
	● 6	43	7.1	0.74	0.85
	● 8	51	9.7	0.72	0.83
	● 10	49	11.9	0.95	1.10
	● 12	55	14.4	0.92	1.06
	● 14	53	16.5	1.13	1.31
	● 16	59	18.4	1.02	1.18
	● 18	59	20.0	1.11	1.28
90	● 18	61	21.3	1.10	1.27

Precipitation rates based on half-circle operation

- Square spacing based on 50% diameter of throw
- ▲ Triangular spacing based on 50% diameter of throw

Performance data collected in zero wind conditions

Performance data derived from tests that conform with ASABE Standards; ASABE S398.1. See page 186 for complete ASABE Test Certification Statement.



Falcon® 6504 Nozzle Performance					METRIC	
Pressure bar	Nozzle	Radius m	Flow m³/h	Flow l/m	■ Precip mm/h	▲ Precip mm/h
2.1	● 4	11.9	0.66	10.98	9	11
	● 6	13.1	0.95	15.90	11	13
2.5	● 4	12.3	0.72	11.92	10	11
	● 6	13.5	1.05	17.56	12	13
	● 8	14.9	1.50	25.20	13	16
	● 10	15.5	1.84	30.60	15	18
	● 12	16.2	2.20	36.60	17	19
	● 14	16.8	2.57	42.60	18	21
	● 16	16.8	2.86	47.40	20	24
3.0	● 4	12.5	0.78	13.02	10	12
	● 6	14.1	1.16	19.34	12	13
	● 8	15.1	1.56	26.04	14	16
	● 10	15.8	1.92	31.99	15	18
	● 12	16.4	2.31	38.44	17	20
	● 14	17.2	2.68	44.63	18	21
	● 16	17.4	3.00	49.95	20	23
3.5	● 4	12.5	0.85	14.09	11	13
	● 6	14.9	1.26	20.96	11	13
	● 8	15.5	1.69	28.24	14	16
	● 10	16.2	2.08	34.70	16	18
	● 12	16.8	2.52	41.98	18	21
	● 14	18.0	2.91	48.45	18	21
	● 16	18.6	3.27	54.53	19	22
4.0	● 4	12.5	0.89	14.91	11	13
	● 6	14.4	1.34	22.33	13	15
	● 8	15.5	1.83	30.44	15	17
	● 10	16.6	2.23	37.17	16	19
	● 12	17.3	2.72	45.28	18	21
	● 14	18.5	3.12	52.01	18	21
	● 16	19.1	3.50	58.37	19	22

Pressure bar	Nozzle	Radius m	Flow m³/h	Flow l/m	■ Precip mm/h	▲ Precip mm/h
4.5	● 4	12.5	0.96	15.94	12	14
	● 6	14.6	1.40	23.33	13	15
	● 8	15.5	1.95	32.43	16	19
	● 10	17.1	2.37	39.44	16	19
	● 12	17.7	2.89	48.17	18	21
	● 14	18.6	3.32	55.38	19	22
	● 16	19.2	3.71	61.82	20	23
5.0	● 4	12.7	1.01	16.84	13	15
	● 6	14.9	1.47	24.50	13	15
	● 8	15.7	2.05	34.16	17	19
	● 10	17.2	2.50	41.64	17	19
	● 12	18.1	3.04	50.72	19	21
	● 14	18.6	3.51	58.49	20	23
	● 16	19.2	3.91	65.11	21	24
5.5	● 4	13.1	1.04	17.39	12	14
	● 6	14.9	1.56	25.79	14	16
	● 8	16.1	2.13	35.54	16	19
	● 10	16.8	2.63	43.84	19	22
	● 12	18.6	3.18	52.92	18	21
	● 14	18.6	3.67	61.23	21	25
	● 16	19.2	4.10	68.40	22	26
6.0	● 18	19.8	4.79	79.77	24	28
6.2	● 18	19.8	4.93	82.13	25	29

Precipitation rates based on half-circle operation

■ Square spacing based on 50% diameter of throw

▲ Triangular spacing based on 50% diameter of throw

Performance data collected in zero wind conditions

Performance data derived from tests that conform with ASABE Standards; ASABE S398.1. See page 186 for complete ASABE Test Certification Statement.



Falcon® 6504 Rain Curtain™ Nozzles

High-Speed Falcon® 6504 Nozzle Performance						METRIC	
Pressure bar	Nozzle	Radius m	Flow m³/h	Flow l/m	■ Precip mm/h	▲ Precip mm/h	
2.1	● 4	11.3	0.68	11.35	11	12	
	● 6	11.9	0.98	15.90	14	16	
2.5	● 4	12.0	0.75	12.54	10	12	
	● 6	12.7	1.22	20.16	15	18	
	● 8	14.2	1.49	25.20	15	17	
	● 10	14.2	1.83	30.60	18	21	
	● 12	14.8	2.24	37.20	20	24	
	● 14	16.0	2.58	43.20	20	23	
	● 16	15.4	2.85	47.40	24	28	
	● 18	16.0	3.15	52.80	24	28	
3.0	● 4	12.5	0.81	13.51	10	12	
	● 6	13.3	1.33	22.18	15	17	
	● 8	14.5	1.57	26.18	15	17	
	● 10	14.5	1.93	32.12	18	21	
	● 12	15.4	2.35	39.20	20	23	
	● 14	16.2	2.71	48.09	21	24	
	● 16	15.8	3.00	49.95	24	28	
	● 18	16.4	3.29	54.87	25	28	
3.5	● 4	12.5	0.85	14.15	11	13	
	● 6	13.7	1.28	21.37	14	16	
	● 8	14.9	1.72	28.62	16	18	
	● 10	14.9	2.11	35.11	19	22	
	● 12	16.2	2.56	42.74	20	23	
	● 14	16.2	2.95	49.20	23	26	
	● 16	16.2	3.27	54.53	25	29	
	● 18	16.9	3.57	59.51	25	29	
4.0	● 4	12.5	0.93	15.52	12	14	
	● 6	13.7	1.38	23.02	15	17	
	● 8	14.4	1.85	30.81	18	21	
	● 10	14.9	2.27	37.86	20	24	
	● 12	16.2	2.76	46.03	21	24	
	● 14	16.2	3.17	52.77	24	28	
	● 16	16.6	3.50	58.37	25	29	
	● 18	17.7	3.83	63.90	24	28	

High-Speed Falcon® 6504 Nozzle Performance						
Pressure bar	Nozzle	Radius m	Flow m³/h	Flow l/m	■ Precip mm/h	▲ Precip mm/h
4.5	● 4	12.5	1.00	16.69	13	15
	● 6	13.4	1.48	24.46	16	19
	● 8	14.6	1.97	32.81	18	21
	● 10	15.3	2.42	40.40	21	24
	● 12	16.5	2.95	49.13	22	25
	● 14	16.2	3.36	55.94	26	30
	● 16	17.1	3.73	62.22	26	30
	● 18	18.0	4.07	67.89	25	29
5.0	● 4	12.3	1.06	17.70	14	16
	● 6	13.1	1.56	25.74	18	21
	● 8	15.1	2.08	34.73	18	21
	● 10	15.4	2.57	42.78	22	25
	● 12	16.8	3.12	51.96	22	26
	● 14	16.2	3.54	59.06	27	31
	● 16	17.5	3.96	65.96	26	30
	● 18	18.0	4.30	71.74	27	31
5.5	● 4	11.9	1.11	18.52	16	18
	● 6	13.1	1.61	26.84	19	22
	● 8	15.5	2.20	36.65	18	21
	● 10	14.9	2.70	44.97	24	28
	● 12	16.8	3.27	54.43	23	27
	● 14	16.2	3.74	62.35	29	33
	● 16	18.0	4.17	69.53	26	30
	● 18	18.0	4.53	75.58	28	32
6.0	● 18	18.4	4.75	79.16	28	32
6.2	● 18	18.6	4.84	80.62	28	32

Precipitation rates based on half-circle operation

■ Square spacing based on 50% diameter of throw

▲ Triangular spacing based on 50% diameter of throw

Performance data collected in zero wind conditions

Performance data derived from tests that conform with ASABE Standards; ASABE S398.1.

See page 186 for complete ASABE Test Certification Statement.

## 8005 Series

Protect Your Turf with High Performance, Vandal and Abuse Resistant Rotors from 39' to 81'

### Features

- Vandal resistance, brass reinforced turret for increased side impact durability
- Memory Arc® returns the rotor to its original arc setting
- Non-strippable drive mechanism prevents damage from vandals
- Easy, wet, dry arc adjustment with slotted screwdriver through top of rotor from 50° to 330° part-circle, 360° non-reversing full-circle. Full and part circle operation in one unit
- Left and right side trips adjustable for ease of installation without turning the case and loosening the pipe connection
- SAM Seal-A-Matic check valve
- 3-port, color-coded Rain Curtain nozzles for optimal long-range, mid-range, and close-in watering
- 5 year warranty

### Options

- **Stainless steel (SS)** riser helps deter vandalism on public turf areas
- **Purple cover (NP)** for non-potable systems

### Operating Specifications

- Radius: 39 to 81 feet (11.9 to 24.7 m)
- Precipitation rate: 0.48 to 1.23 inches per hour (12 to 31 mm/h)
- Pressure: 50 to 100 psi (3.5 to 6.9 bar)
- Flow: 3.8 to 36.3 gpm (0.86 to 8.24 m<sup>3</sup>/h; 14.4 to 137.4 l/m)
- 1" (26/34) NPT or BSP female threaded inlet
- SAM check device holds up to 10 feet (3.1 m) of head
- Nozzle outlet trajectory is 25°
- Rain Curtain™ Nozzles: 04 - black; 06 - light blue; 08 - dark green; 10 - gray; 12 - beige; 14 - light green; 16 - dark brown; 18 - dark blue; - 20 - red; 22 - yellow; 24 - orange; 26 - white

**Note:** Flow ranges of 7005 and 8005 are combined into 8005 rotor

### Models

- 8005: 1" NPT female threaded inlet (plastic riser stem)
- 8005-NP: 1" NPT female threaded inlet (plastic riser stem with non-potable cover)
- 8005-SS: 1" NPT female threaded inlet (5" stainless steel covered riser stem)
- 8005-SS-NP: 1" NPT female threaded inlet (5" stainless steel covered riser stem with non-potable cover)
- Optional Sod Cup

**Note:** All models available with BSP threads

**\*\* Note:** Pop-up height is measured from cover to the primary nozzle port. Overall body height is measured popped down



8005 Series

 0.48 to 1.23 in/hr  
(12 to 31 mm/h)

 50 to 100 psi  
(3.5 to 6.9 bar)

 3.8 to 36.3 gpm  
(14.4 to 137.4 l/m)  
(0.86 to 8.24 m<sup>3</sup>/h)

 5" (12.7 cm)  
10 1/8" (25.7 cm)  
1" (26/34) NPT  
or BSP

### How To Specify

**8005 - SS - NP - 16**

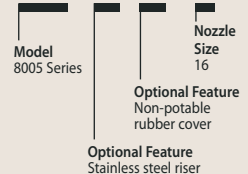

*Note: For non-U.S. applications, it is necessary to specify NPT or BSP thread type.*



### 8005 Nozzle Performance

Pressure psi	Nozzle	Radius ft.	Flow gpm	■ Precip In/h	▲ Precip In/h
50	● 04	39	3.8	0.48	0.56
	● 06	45	5.6	0.53	0.62
	● 08	49	6.6	0.53	0.61
	● 10	53	9.3	0.64	0.74
	● 12	57	11.1	0.66	0.76
	● 14	59	12.6	0.70	0.81
	● 16	61	14.3	0.74	0.85
	● 18	63	16.1	0.78	0.90
	● 20	65	18.6	0.85	0.98
	● 22	65	20.7	0.94	1.09
	● 24	63	22.3	1.08	1.25
	○ 26	65	24.3	1.11	1.28
60	● 04	39	3.8	0.48	0.56
	● 06	45	6.1	0.58	0.67
	● 08	49	8.4	0.67	0.78
	● 10	53	10.1	0.69	0.80
	● 12	59	12.0	0.66	0.77
	● 14	61	14.3	0.74	0.85
	● 16	65	15.9	0.72	0.84
	● 18	65	17.8	0.81	0.94
	● 20	67	20.1	0.86	1.00
	● 22	71	23.2	0.89	1.02
	● 24	69	24.7	1.00	1.15
	○ 26	73	26.7	0.96	1.11
70	● 04	39	4.7	0.60	0.69
	● 06	45	6.7	0.64	0.74
	● 08	49	9.0	0.72	0.83
	● 10	55	11.1	0.71	0.82
	● 12	59	13.2	0.73	0.84
	● 14	63	15.3	0.74	0.86
	● 16	67	17.2	0.74	0.85
	● 18	67	19.3	0.83	0.96
	● 20	71	22.0	0.84	0.97
	● 22	73	25.2	0.91	1.05
	● 24	75	27.0	0.92	1.07
	○ 26	75	29.4	1.01	1.16
80	● 04	39	5.0	0.63	0.73
	● 06	45	7.1	0.68	0.78
	● 08	49	9.8	0.79	0.91
	● 10	55	11.8	0.75	0.87
	● 12	61	14.2	0.73	0.85
	● 14	63	16.4	0.80	0.92
	● 16	67	18.6	0.80	0.92
	● 18	69	20.9	0.85	0.98
	● 20	71	23.9	0.91	1.05
	● 22	75	27.3	0.93	1.08
	● 24	77	29.2	0.95	1.10
	○ 26	79	31.5	0.97	1.12

Pressure psi	Nozzle	Radius ft.	Flow gpm	■ Precip In/h	▲ Precip In/h
90	● 12	61	14.7	0.76	0.88
	● 14	65	17.9	0.82	0.94
	● 16	69	20.0	0.81	0.93
	● 18	71	22.2	0.85	0.98
	● 20	73	25.3	0.91	1.06
	● 22	75	29.1	1.00	1.15
	● 24	79	31.0	0.96	1.10
100	○ 26	79	33.7	1.04	1.20
	● 20	75	26.8	0.85	0.97
	● 22	77	30.7	1.00	1.15
	● 24	79	32.8	1.01	1.17
	○ 26	81	36.3	1.07	1.23

Precipitation rates based on half-circle operation

■ Square spacing based on 50% diameter of throw

▲ Triangular spacing based on 50% diameter of throw

Performance data collected in zero wind conditions

Performance data derived from tests that conform with ASABE Standards; ASABE S398.1.

See page 186 for complete ASABE Test Certification Statement.



8005 Cutaway



Sod Cup for 8005

8005 Nozzle Performance						METRIC	
Pressure bar	Nozzle	Radius m	Flow m <sup>3</sup> /h	Flow l/m	■ Precip mm/h	▲ Precip mm/h	
3.5	● 4	11.9	0.86	14.38	12	14	
	● 6	13.7	1.28	21.34	14	16	
	● 8	14.9	1.59	25.50	14	16	
	● 10	16.1	2.10	35.43	16	19	
	● 12	17.5	2.52	42.27	16	19	
	● 14	18.0	2.89	48.18	18	21	
	● 16	18.7	3.28	54.59	19	22	
	● 18	19.2	3.69	61.43	20	23	
	● 20	19.9	4.25	70.83	21	25	
	● 22	20.0	5.08	79.07	25	29	
	● 24	19.3	5.11	85.10	27	32	
○ 26	20.0	5.57	92.67	28	32		
4.0	● 4	11.9	0.93	14.38	13	15	
	● 6	13.7	1.37	22.71	15	17	
	● 8	14.9	1.75	30.44	16	18	
	● 10	16.3	2.30	37.63	17	20	
	● 12	17.7	2.70	44.74	17	20	
	● 14	18.5	3.17	52.85	19	21	
	● 16	19.6	3.54	58.98	18	21	
	● 18	19.7	3.97	66.10	20	24	
	● 20	20.3	4.50	74.95	22	25	
	● 22	21.3	5.23	85.94	23	27	
	● 24	20.7	5.50	91.69	26	30	
○ 26	21.8	6.01	99.26	25	29		
4.5	● 4	11.9	1.00	16.18	14	16	
	● 6	13.7	1.45	24.28	15	18	
	● 8	14.9	1.92	32.99	17	20	
	● 10	16.5	2.40	40.22	18	20	
	● 12	18.0	2.87	47.81	18	20	
	● 14	18.9	3.37	56.12	19	22	
	● 16	20.1	3.77	62.77	19	22	
	● 18	20.1	4.22	70.36	21	24	
	● 20	21.1	4.79	79.87	22	25	
	● 22	22.0	5.51	91.80	23	26	
	● 24	22.0	5.88	98.08	24	28	
○ 26	22.6	6.42	106.44	25	29		
5.0	● 4	11.9	1.06	18.08	15	17	
	● 6	13.7	1.54	25.74	16	19	
	● 8	14.9	2.09	34.83	19	22	
	● 10	16.7	2.50	42.68	18	21	
	● 12	18.3	3.05	50.92	18	21	
	● 14	19.2	3.54	58.96	19	22	
	● 16	20.4	3.99	66.44	19	22	
	● 18	20.6	4.47	74.58	21	24	
	● 20	21.6	5.11	85.08	22	25	
	● 22	22.4	5.84	97.39	23	27	
	● 24	23.0	6.26	104.29	24	27	
○ 26	23.2	6.80	113.28	25	29		

Pressure bar	Nozzle	Radius m	Flow m <sup>3</sup> /h	Flow l/m	■ Precip mm/h	▲ Precip mm/h
5.5	● 4	11.9	1.13	18.90	16	18
	● 6	13.7	1.62	26.84	17	20
	● 8	14.9	2.25	37.02	20	23
	● 10	16.8	2.70	44.60	19	22
	● 12	18.5	3.23	53.66	19	22
	● 14	19.2	3.72	61.98	20	23
	● 16	20.4	4.22	70.28	20	23
	● 18	21.0	4.74	78.97	21	25
	● 20	21.6	5.42	90.30	23	27
	● 22	22.8	6.19	103.15	24	28
	● 24	23.5	6.62	110.33	24	28
○ 26	24.1	7.14	119.05	25	28	
6.0	● 12	18.6	3.30	55.07	19	22
	● 14	19.6	3.96	66.06	21	24
	● 16	20.9	4.45	74.12	20	24
	● 18	21.5	4.95	82.56	21	25
	● 20	22.1	5.65	94.18	23	27
	● 22	22.9	6.71	108.12	26	30
6.2	● 24	23.9	6.92	115.31	24	28
	○ 26	24.1	7.50	125.08	26	30
	● 14	19.8	4.06	67.75	21	24
	● 16	21.0	4.54	75.70	21	24
6.5	● 18	21.7	5.04	84.02	21	25
	● 20	22.5	5.89	98.19	23	27
	● 22	23.4	6.84	112.73	25	29
	● 24	24.1	7.22	120.25	25	29
6.9	○ 26	24.3	7.91	131.76	27	31
	● 20	22.9	6.09	101.43	23	27
	● 22	23.5	6.97	116.19	25	29
6.9	● 24	24.1	7.45	124.14	26	30
	○ 26	24.7	8.24	137.39	27	31

Precipitation rates based on half-circle operation

■ Square spacing based on 50% diameter of throw

▲ Triangular spacing based on 50% diameter of throw

Performance data collected in zero wind conditions

Performance data derived from tests that conform with ASABE Standards; ASABE S398.1. See page 186 for complete ASABE Test Certification Statement.



8005 Rain Curtain™ Nozzles

Optional High-flow Nozzles for 8005 Series Rotors

## Rain Curtain™ Nozzle Cross Reference Guide Hunter® vs. Rain Bird

## Rain Curtain™ Nozzle Cross Reference Guide Toro® vs. Rain Bird

Hunter vs. Rain Bird – 3/4" Rotors		
If replacing:	Use Rain Bird Nozzle	
	By Flow	By Radius
PGP	5000 Series	5000 Series
1	-	-
2	-	-
3	-	-
4	1.5	1.5
5	2.0	2.0
6	2.5	2.5
7	3.0	3.0
8	4.0	4.0
9	5.0	5.0
10	8.0	6.0
11	-	8.0
12	-	8.0

Toro vs. Rain Bird – 3/4" Rotors		
If replacing:	Use Rain Bird Nozzle	
	By Flow	By Radius
Super 800	5000 Series	5000 Series
0.5	-	-
0.75	-	-
1.0	1.5	1.5
2.0	2.5	2.0
2.5	3.0	2.5
3.0	4.0	2.5
4.0	5.0	3.0
6.0	6.0	4.0
8.0	8.0	5.0

Rotors

Hunter vs. Rain Bird – 3/4" Rotors				
If replacing:	Use Rain Bird Nozzle			
	By Flow		By Radius	
I-20	5000 Series	5500	5000 Series	5500
0.5 SR	-	-	-	○ 18S
1.0 SR	-	-	-	○ 18S
2.0 SR	-	○ 18S	-	○ 18S
0.75 SR	-	-	-	○ 22S
1.5 SR	-	○ 22S	-	○ 22S
3.0 SR	-	○ 26S	-	○ 22S
1.0	1.5	-	1.5	○ 30S
1.5	1.5	● 2	1.5	○ 30S
2.0	2.0	● 2	2.0	● 2
3.0	2.5	● 3	2.5	● 2
3.5	3.0	● 4	3.0	● 3
4.0	4.0	● 5	4.0	● 3
6.0	5.0	● 6	5.0	● 4
8.0	6.0	● 8	6.0	● 8

Toro vs. Rain Bird – 3/4" Rotors				
If replacing:	Use Rain Bird Nozzle			
	By Flow		By Radius	
TR50	5000 Series	5505	5000 Series	5505
● 1.0	-	-	-	-
● 1.5	1.5	● 2	1.5	● 2
● 2.0	2.0	● 2	2.0	● 3
● 3.0	3.0	● 3	3.0	● 3
● 4.5	4.0	● 5	4.0	● 3
● 6.0	5.0	● 6	4.0	● 4
● 7.5	6.0	● 8	4.0	● 4
● 9.0	8.0	● 10	5.0	● 4

Hunter vs. Rain Bird – 1" Rotors				
If replacing:	Use Rain Bird Nozzle			
	By Flow		By Radius	
I-25	6504	8005	6504	8005
● 4	● 4	● 4	● 4	● 4
○ 5	● 6	● 6	● 6	● 6
● 7	● 8	● 8	● 8	● 8
● 8	○ 10	○ 10	● 8	● 8
● 10	○ 12	○ 12	○ 10	○ 10
● 13	○ 12	○ 12	○ 12	○ 12
○ 15	○ 14	○ 14	○ 14	○ 12
● 18	● 16	● 16	● 16	○ 14
● 20	● 18	● 18	● 18	○ 14
● 23	-	● 22	-	○ 16
● 25	-	● 24	-	● 20
● 28	-	○ 26	-	● 22
I-40	6504	8005	6504	8005
40	● 8	● 8	● 6	● 8
41	○ 12	○ 12	○ 10	○ 10
42	○ 12	○ 12	○ 10	○ 12
43	● 16	● 16	○ 14	○ 14
44	● 18	● 20	● 18	○ 16
45	-	● 22	-	● 20
I-35	6504	8005	6504	8005
● 9	● 8	● 8	● 8	● 8
○ 12	○ 12	○ 12	○ 10	○ 10
○ 15	○ 14	○ 14	○ 12	○ 12
● 18	● 16	● 16	○ 14	○ 14
● 21	● 18	● 18	○ 14	○ 14
● 24	-	● 22	● 16	○ 16
● 27	-	● 24	● 16	○ 16
● 30	-	○ 26	-	● 20

Toro vs. Rain Bird – 1" Rotors				
If replacing:	Use Rain Bird Nozzle			
	By Flow		By Radius	
Toro 2001	6504	8005	6504	8005
● 9	○ 10	○ 10	○ 10	○ 10
● 12	○ 12	○ 12	○ 12	○ 12
● 15	● 16	● 16	○ 14	○ 14
● 18	● 18	● 20	● 18	○ 16
● 24	-	● 22	-	● 20
TR70	6504	8005	6504	8005
● 7	● 8	● 8	-	● 6
● 9	● 8	● 8	● 8	● 8
● 12	○ 12	○ 12	○ 10	○ 10
● 16	● 16	● 16	○ 14	○ 12
● 20	-	● 20	○ 14	○ 14
● 24	-	● 20	● 16	○ 14
● 27	-	● 20	● 18	○ 16
Toro 640	6504	8005	6504	8005
40	● 8	● 8	● 8	○ 10
41	○ 10	○ 12	○ 10	○ 10
42	○ 14	○ 14	○ 12	○ 12
43	● 16	● 16	○ 14	○ 14
44	● 18	● 20	● 16	○ 14

## 2045A Maxi-Paw™ and 2045-PJ Maxi-Bird™

Dirty Water Applications - Spacing Up to 45 Feet (13.7 m)

### Features

- Proven impact drive with straight-through flow for superior performance in dirty water
- Five standard trajectory and two low angle (LA) color-coded nozzles for matched precipitation and in a wide range of applications
- 360° full-circle OR arc adjustable from 20° to 340°
- Side and combination ½" or ¾" bottom inlet for design flexibility (Maxi-Paw)
- 3 year warranty

### Operating Specifications

- Precipitation rate: 0.28 to 1.21 inches per hour (7 to 31 mm/h)
- Spacing: 22 to 45 feet (6.7 to 13.7 m)
- Flow rate: 1.5 to 8.4 gpm (0.34 to 1.91 m³/h; 0.9 to 0.53 l/s)
- Radius: 22 to 45 feet (6.7 to 13.7 m); 18 feet (5.4 m) with Radius Reduction Screw
- Pressure: 25 to 60 psi (1.7 to 4.1 bar)
- Combination ½" or ¾" female bottom inlet (Maxi-Paw)
- ½" FPT side inlet (Maxi-Paw)
- ½" (15/21) Riser-Mounted (Maxi-Bird)

### Models

- 2045A Maxi-Paw
- 2045A Maxi-Paw-SAM
- 2045A Maxi-Paw-SAM-NP
- 42064: Maxi-Paw Wrench - for removing internal assembly from case
- 2045-PJ Maxi-Bird



2045A Maxi-Paw



2045-PJ Maxi-Bird



42064

### How To Specify

**2045A- SAM-10- LA**

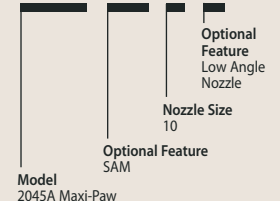

Maxi-Paw and Maxi-Bird Nozzle Performance					
Pressure psi	Nozzle	Radius ft.	Flow gpm	■ Precip In/h	▲ Precip In/h
25	● 06	-	-	-	-
	● 07 LA	22	1.5	0.60	0.69
	● 07	32	2.2	0.41	0.48
	● 08	35	2.8	0.44	0.51
	● 10 LA	25	3.4	1.05	1.21
	● 10	38	4.2	0.56	0.65
35	● 12	39	5.5	0.70	0.80
	● 06	37	2.0	0.28	0.32
	● 07 LA	23	1.9	0.69	0.80
	● 07	37	2.7	0.38	0.44
	● 08	38	3.3	0.44	0.51
	● 10 LA	29	4.0	0.92	1.06
45	● 10	41	4.8	0.55	0.64
	● 12	42	6.3	0.69	0.79
	● 06	38	2.3	0.31	0.35
	● 07 LA	25	2.1	0.65	0.75
	● 07	39	3.0	0.38	0.44
	● 08	40	3.7	0.45	0.51
55	● 10 LA	31	4.5	0.90	1.04
	● 10	42	5.4	0.59	0.68
	● 12	44	7.1	0.71	0.82
	● 06	38	2.5	0.33	0.39
	● 07 LA	25	2.3	0.71	0.82
	● 07	41	3.3	0.38	0.44
60	● 08	41	4.1	0.47	0.54
	● 10 LA	32	5.0	0.94	1.09
	● 10	43	6.0	0.62	0.72
	● 12	45	7.9	0.75	0.87
	● 06	38	2.6	0.35	0.40
	● 07 LA	25	2.4	0.74	0.85
	● 07	41	3.5	0.40	0.46
	● 08	42	4.2	0.46	0.53
	● 10 LA	32	5.4	1.02	1.17
	● 10	44	6.4	0.64	0.74
	● 12	45	8.4	0.80	0.92

Maxi-Paw and Maxi-Bird Nozzle Performance METRIC						
Pressure bar	Nozzle	Radius m	Flow m <sup>3</sup> /h	Flow l/m	■ Precip mm/h	▲ Precip mm/h
2.0	● 6	-	-	-	-	-
	● 07 LA	6.8	0.38	6.0	16	19
	● 7	10.4	0.55	9.0	10	12
	● 8	11.0	0.68	11.4	11	13
	● 10 LA	8.1	0.83	13.8	25	29
	● 10	11.9	1.01	16.8	14	16
2.5	● 12	12.3	1.32	22.2	18	20
	● 6	11.3	0.46	7.8	7	8
	● 07 LA	7.1	0.44	7.2	17	20
	● 7	11.4	0.62	10.2	10	11
	● 8	11.7	0.76	12.6	11	13
	● 10 LA	8.9	0.92	15.6	23	27
3.0	● 10	12.5	1.11	18.6	14	16
	● 12	12.9	1.45	24.0	18	20
	● 6	11.5	0.51	8.4	8	9
	● 07 LA	7.5	0.47	7.8	17	19
	● 7	11.8	0.67	11.4	10	11
	● 8	12.1	0.83	13.8	11	13
3.5	● 10 LA	9.4	1.01	16.8	23	27
	● 10	12.8	1.21	20.4	15	17
	● 12	13.3	1.59	26.4	18	21
	● 6	11.6	0.55	9.0	8	9
	● 07 LA	7.6	0.50	8.4	17	20
	● 7	12.2	0.72	12.0	10	11
4.0	● 8	12.4	0.89	15.0	12	13
	● 10 LA	9.6	1.09	18.0	23	27
	● 10	13.0	1.30	21.6	15	18
	● 12	13.6	1.72	28.8	19	21
	● 6	11.6	0.58	9.6	9	10
	● 07 LA	7.6	0.54	9.0	18	21
	● 7	12.5	0.78	13.2	10	11
	● 8	12.7	0.94	15.6	12	14
	● 10 LA	9.8	1.19	19.8	25	29
	● 10	13.3	1.42	23.4	16	19
	● 12	13.7	1.86	31.2	20	23

LA = Low Angle

Precipitation rates based on half-circle operation

■ Square spacing based on 50% diameter of throw

▲ Triangular spacing based on 50% diameter of throw

Performance data collected in zero wind conditions

Performance data derived from tests that conform with ASABE Standards; ASABE S398.1.

See page 186 for complete ASABE Test Certification Statement.



2045A Maxi-Paw and 2045-PJ  
Standard Angle Nozzles



2045A Maxi-Paw and 2045-PJ  
Low Angle Nozzles



## TSJ/TSJ-PRS Series

Swing Joints Connect ¾" (1.9 cm) and 1" (2.5 cm) Rotors or Quick Coupler Valves to Lateral Pipes

### Features

- Preassembled units save the contractor time and reduce installation costs
- Excellent structural integrity from the swept elbow design reduces the costs associated with fatigue related failures
- Double O Ring provides extra protection against leaks and keeps threads clean of debris making hand tightening easy
- The TSJ-PRS combines the great flow characteristics of the Rain Bird turf swing joint with an inline pressure regulating outlet elbow for controlling and maintaining constant pressure right at the rotor inlet

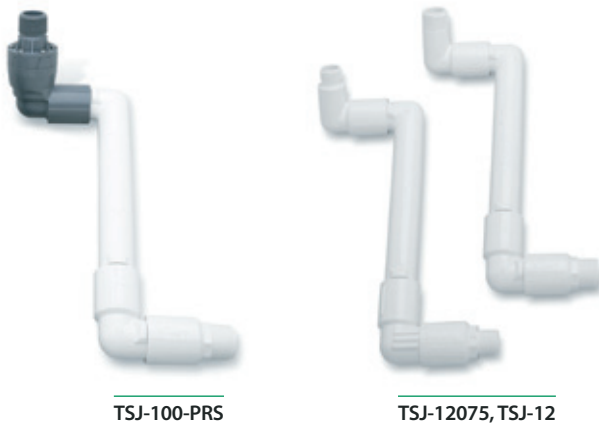

### Operating Specifications

- Pressure rating: 315 psi at 73° F (21.7 bar at 22.8° C) (per ASTM D3139)
- ¾" joint pressure loss: 0.3 psi at 6 gpm (0.02 bar at 0.4 l/s)
- 1" joint pressure loss: 1.5 psi at 18 gpm; 2.5 psi at 23 gpm (0.1 bar at 1,1 l/s; 0.2 bar at 1.5 l/s)
- TSJ-PRS maximum flow: 22 gpm (1.41 l/s)

### TSJ-PRS Application Information

- The TSJ-PRS is not recommended for use in systems where the pressure in the lateral lines is equal to or less than the nominal regulation pressure, as the increased pressure drop may adversely affect the performance of such systems
- To reduce the effects of water hammer, Rain Bird recommends flow rates in the supply line not exceed 5 ft/sec (1.5 m/s). The TSJ-PRS is not intended to function as a water hammer prevention device
- There are no user-serviceable parts inside. The internal spring is under compression. Do not open the PRS unit under any circumstances

### Models

- TSJ-12075: 12" (30.5 cm) long, ¾" (20/27) M x M NPT swing joint
- TSJ-12: 12" (30.5 cm) long, 1" (26/34) M x M NPT swing joint
- TSJ-100-PRS: 1" swing joint with 70 psi pressure regulator, 12" (30.5 cm) long, 1" (26/34) M x M NPT inlet and outlet

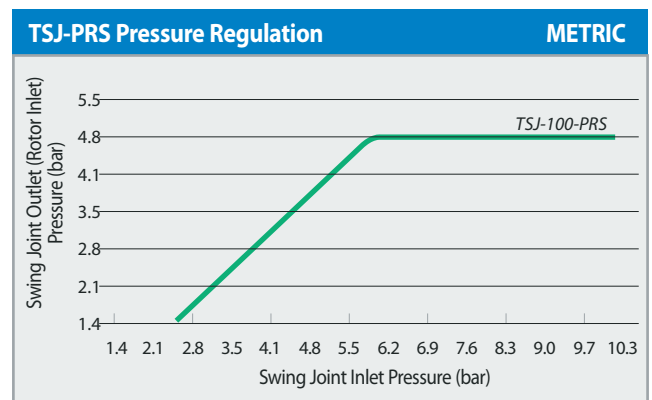
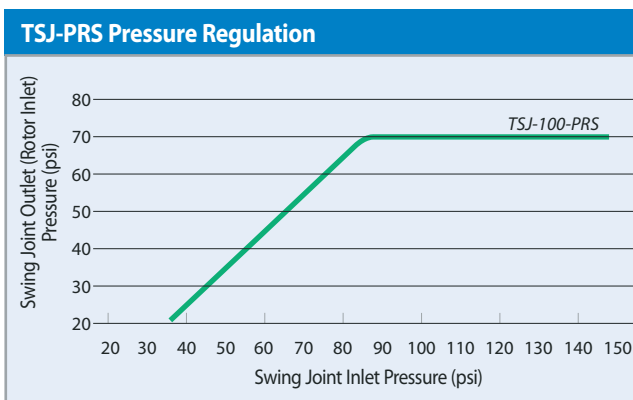

### Swing Joint Specifications

Model Number	Length		Inlet		Outlet		Thread	Pressure Regulation	
	US	METRIC	US	METRIC	US	METRIC		US	METRIC
TSJ-12075	12"	30.5 cm	¾" M	20/27 M	¾" M	20/27 M	NPT	n/a	n/a
TSJ-12	12"	30.5 cm	1" M	26/34 M	1" M	26/34 M	NPT	n/a	n/a
TSJ-100-PRS	12"	30.5 cm	1" M	26/34 M	1" M	26/34 M	NPT	70 psi	70 psi

# Valves

Introduction

Spray/Bodies

Spray Nozzles

Rotors

Valves

Controllers

Central Controls

Landscape Drip

Pumps & Filtration

Drainage Products

Resources



### The Toughest, Most Reliable Valves In their Class

Relentless research, testing and retesting have led to a product you can stand behind. The Rain Bird® PGA valve is the preferred valve for high-end residential and light commercial jobs.

## Major Products

Primary Applications	DV	DVF	ASVF	HV	HVF	PGA	PEB	PESB/PESB-R	EFB-CP	BPES	QC
Manual Bleed	I/E	I/E	I/E	I/E	I/E	I	I/E	I/E	I/E	E	
Flow Control		•	•		•	•	•	•	•	•	
Bottom Inlet	DV-A		•			•				•	•
Low Flow	•	•	•	•	•		•	•	•		
PRS-Dial Compatible						•	•	•	•	•	
Dirty Water								•	•	•	
Non-Potable Water						•	•	•	•	•	•
Sites Requiring Brass									•	•	•
Sites Requiring Plastic	•	•	•	•	•	•	•	•			
Decoder System Compatible						•	•	•	•	•	

• DV/DVF available in globe, angle, slip x slip, and male x barb configurations. • Flows below 3 gpm (0.68 m<sup>3</sup>/h; 0.19 l/s) install 200 mesh filter upstream. • I/E = Internal/External  
 • The PESB-R and EFB-CP are specifically designed with chlorine-resistant components for reclaimed water applications.



## Water Saving Tips

- The PRS-Dial is an excellent means of regulating outlet pressure at the valve regardless of incoming pressure fluctuations. It helps ensure optimal pressure performance at the head.
- Rain Bird valves provide excellent filtration characteristics for maximum reliability in a wide range of environments.
- PESB-R and EFB-CP reclaimed valves provide reliable operation in all water conditions. Valve diaphragms are composed of EPDM, a rubber material which is chlorine and chemical resistant.

## DV / DVF Series

Diaphragm Valve – The Industry Leader for Over 25 Years

### Features

- Double-filtered (diaphragm and solenoid) pilot-flow design for maximum reliability and grit resistance
- Buna-N, balanced diaphragm with self-cleaning 90 mesh (200 micron) pilot water filter and captive spring
- Energy-efficient, low-power encapsulated solenoid with captured plunger and 90-mesh (200 micron) solenoid filter
- Unique, easy-to-turn patented pressure assisted flow control mechanism (DVF models only)
- External bleed to manually flush system of dirt and debris during installation and system start-up
- Internal bleed for spray-free manual operation
- Accepts Rain Bird TBOS latching solenoid for use with most battery-operated controllers
- Operates in low-flow and Landscape Drip applications when a 200 mesh filter is installed upstream
- **Not recommended for use with two-wire control systems**

### Specifications

- Pressure: 15 to 150 psi (1,0 to 10,4 bar)
- 075-DV Non-Flow Control Model: 0.2 to 22 GPM (0,05 to 5,0 m<sup>3</sup>/h; 0,01 to 1,39 l/s). For flows below 3 GPM (0,68 m<sup>3</sup>/h; 0,19 l/s) or any Landscape Drip application, use a 200 mesh filter installed upstream
- 100-DV Non-Flow Control Model: 0.2 to 40 gpm (0,05 to 9,085 m<sup>3</sup>/h; 0,01 to 2,52 l/s). For flows below 3 gpm (0,68 m<sup>3</sup>/h; 0,19 l/s) or any Landscape Drip application, use a 200 mesh filter installed upstream
- 100-DVF Flow Control Model: 0.2 to 40 gpm (0,05 to 9,085 m<sup>3</sup>/h; 0,01 to 2,52 l/s); For flows below 3 gpm (0,68 m<sup>3</sup>/h; 0,19 l/s) or any Landscape Drip application, use a 200 mesh filter installed upstream
- Water Temperature: Up to 110° F (43° C)
- Ambient air temperature: Up to 125° F (52° C)
- 24 VAC 50/60 Hz (cycles per second) solenoid power requirement: 0.450A inrush current; 0.250A holding current
- Solenoid coil resistance: 38 Ohms



075-DV



100-DVF-MB



100-DV-A



100-DVF

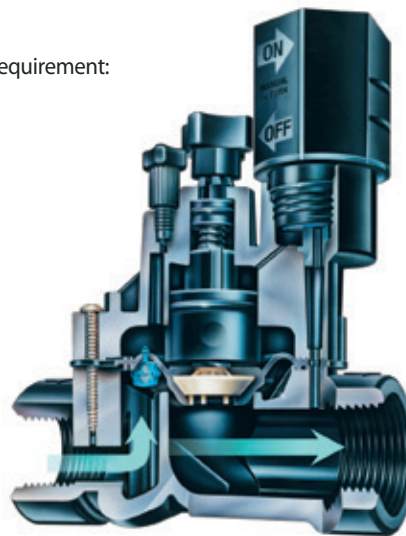

DVF Cutaway

### How To Specify

100 - DV - MB

Optional Configuration:  
MB: Male x Barb  
A: Angle  
SS: Slip x Slip

#### Model

DV: Remote Control Valve  
DVF: Remote Control Valve with Flow Control

#### Size

075: 3/4" (20/27);  
100: 1" (26/34)

*This specifies a 100-DV valve, 1" (26/34) male x barb with flow control. Note: For non-U.S. applications it is necessary to specify NPT or BSP thread type (1" only).*

## DV / DVF Series (cont.)

### Dimensions

#### DV Valves

- Height: 4½" (11.4 cm)
- Height (Angle): 5½" (14 cm)
- Length: 4¾" (11.1 cm)
- Length (Angle): 3¾" (9.5 cm)
- Length (MB): 5¾" (14.6 cm)
- Width: 3½" (8.4 cm)

#### DVF Valves

- Height: 5¾" (14.2 cm)
- Length: 4¾" (11.1 cm)
- Length (MB): 5¾" (14.6 cm)
- Width: 3½" (8.4 cm)

### Models

- 075-DV: ¾" (20/27) NPT
- 100-DV: 1" (26/34) NPT female x female\*
- 100-DV-SS: 1" (26/34) slip x slip
- 100-DV-A: 1" (26/34) NPT female x female
- 100-DV-MB: 1" (26/34) male x barb
- 100-DVF: 1" (26/34) NPT female x female\*
- 100-DVF-SS: 1" (26/34) slip x slip
- 100-DVF-MB: 1" (26/34) male x barb

\* Available with BSP threads

#### Recommendations

1. Rain Bird recommends flow rates that result in discharge velocities in the supply line not to exceed 7.5 ft/sec (2.3 m/s) in order to reduce the effects of water hammer.
2. Rain Bird residential valves cannot be used with PRS pressure regulating modules.
3. **Not recommended for use with two-wire systems.**

DV and DVF Valve Pressure Loss (psi)		
Flow gpm	075-DV ¾" psi	100-DV/100-DVF 1" psi
1	3.2	3.3
3	3.9	3.6
5	4.2	3.8
10	5.0	3.8
20	7.7	5.1
30	-	6.4
40	-	8.6

DV and DVF Valve Pressure Loss (bar)			METRIC
Flow m³/h	l/m	075-DV ¾" bar	100-DV/100-DVF 1" bar
0.23	4	0.22	0.23
0.60	10	0.26	0.24
1.20	20	0.29	0.26
3.60	60	0.45	0.32
4.50	75	0.53	0.35
6.00	100	-	0.41
9.00	150	-	0.59

100-DV Angle, MxB Valve Pressure Loss (psi)		
Flow gpm	Angle 1" psi	Male x barb 1" psi
1	2.8	2.5
3	3.0	2.9
5	3.2	3.0
10	3.9	3.1
20	4.3	4.3
30	5.4	7.4
40	8.2	12.7

100-DV Angle, MxB Valve Pressure Loss (bar)			METRIC
Flow m³/h	l/m	Angle 1" bar	Male x barb 1" bar
0.23	4	0.19	0.17
0.60	10	0.20	0.19
1.20	20	0.22	0.21
3.60	60	0.28	0.26
4.50	75	0.30	0.30
6.00	100	0.35	0.44
9.00	150	0.56	0.86

**Note:** DV/DVF Male x barb not recommended for flows exceeding 30 gpm (6.81 m³/h, 113.56 l/m)

## ASVF Series

Anti-siphon Valve with Flow Control – The Industry Leader for Over 20 Years

### Features

- Combination of the reliable DVF Angle valve and atmospheric backflow preventer in one unit
- Incorporates all features of DV/DVF Series valves
- I.A.P.M.O. and A.S.S.E listing approved
- City of Los Angeles listing approved
- **Not recommended for use with two-wire control systems**

### Specifications

- Pressure: 15 to 150 psi (1,0 to 10,4 bar)
- 075-ASVF Flow: 0.2 to 22 GPM (0,05 to 5,0 m<sup>3</sup>/h; 0,01 to 1,39 l/s). For flows below 3 GPM (0,68 m<sup>3</sup>/h; 0,19 l/s) or any Landscape Drip products application, use a 200 mesh filter installed upstream
- 100-ASVF Flow: 0.2 to 40 GPM (0,05 to 9,085 m<sup>3</sup>/h; 0,01 to 2,52 l/s). For flows below 3 GPM (0,68 m<sup>3</sup>/h; 0,19 l/s) or any Landscape Drip products application, use a 200 mesh filter installed upstream
- Water temperature: Up to 110° F (43° C)
- Ambient air temperature: Up to 125° F (52° C)
- 24 VAC 50/60 Hz (cycles per second) solenoid power requirement: 0.450A inrush current; 0.250A holding current
- Solenoid coil resistance: 38 Ohms

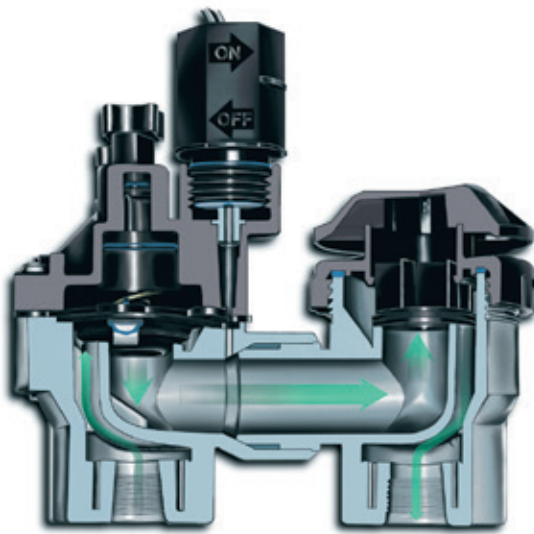

ASVF Cutaway

### Installation Notes

- Anti-siphon valve must be installed upright
- Anti-siphon unit must be installed at least 6" (15,2 cm) above the highest point of water in the pipe and sprinklers it serves
- No valve can be located downstream of the anti-siphon valve
- Anti-siphon valves must not be subjected to operating pressure for more than twelve (12) hours in any twenty-four (24) hour period
- Uniform Plumbing Code Sec. 1003 (2) 602.2 Consult local codes

### Dimensions

- Height: 6¼" (15.8 cm)
- Length: 6¼" (15.5 cm)
- Width: 3⅓" (8.1 cm)

### Models

- 075-ASVF: ¾" (20/27)
- 100-ASVF: 1" (26/34)

Models available in NPT threads only

### Recommendations

1. Rain Bird recommends flow rates that result in discharge velocities in the supply line not to exceed 7.5 ft/sec (2.3 m/s) in order to reduce the effects of water hammer.
2. Rain Bird residential valves cannot be used with PRS pressure regulating modules.
3. Not recommended for use with two-wire systems.



100-ASVF

### ASVF Valve Pressure Loss (psi)

Flow gpm	075-ASVF ¾" psi	100-ASVF 1" psi
1	2.8	2.9
3	3.4	3.1
5	3.8	3.3
10	4.6	3.9
20	6.5	5.0
30	-	7.8
40	-	13.4

### ASVF Valve Pressure Loss (bar)

		METRIC	
Flow m <sup>3</sup> /h	l/m	075-ASVF ¾" bar	100-ASVF 1" bar
0.23	3.8	0.19	0.20
0.6	10	0.23	0.21
1.2	20	0.26	0.23
3.6	60	0.39	0.31
4.5	75	0.45	0.34
6.0	100	-	0.47
9.0	150	-	0.91

\* Rain Bird recommends flow rates in the supply line not to exceed 7.5 ft/sec (2.3 m/s) in order to reduce the effects of water hammer

## HV Series

High Value Valve. High Performance. Big Savings.

### Features

- Patented, eccentric, balanced pressure, Buna-N diaphragm with self-cleaning 90-mesh (200 micron) pilot water filter and captured stainless steel spring – Eccentric design provides smoother closing, less water hammer
- Only four durable, captured multi-drive bonnet screws that come out with half the number of turns for fast and easy servicing – at least twice as fast as the competition
- Glass-filled polypropylene body for strength (slip by slip model bodies are PVC)
- All popular model configurations available
- Compact design, 2.54" spin radius for tight installations
- Reverse flow, normally closed design
- External bleed to manually flush system of dirt and debris during installation and system start-up
- Internal bleed for spray-free manual operation
- Operates in low-flow and Landscape Drip applications when a 200 mesh filter is installed upstream

### Specifications

- Pressure: 15 to 150 PSI (1,0 to 10,3 bar)
- Flow: 0.2 to 30 GPM (0,05 to 6,82 m<sup>3</sup>/h; 0,01 to 1,89 l/s); for flows below 3 GPM (0,68 m<sup>3</sup>/h; 0,19 l/s) or any Landscape Drip application, use a 200 mesh filter installed upstream
- Operating Temperatures: Water temperature up to 110° F (43° C); ambient temperature up to 125° F (52° C)
- 24 VAC 50/60 Hz (cycles/sec.) solenoid
- Inrush current: 0.290A at 60 Hz
- Holding current: 0.091A at 60 Hz
- Solenoid Coil resistance: 70-85 Ohms (40° F - 110° F)



### HV Valve Pressure Loss (psi)

Flow (gpm)	1" HV (psi)	1" HV-MB (psi)
1	1.57	1.73
3	2.07	2.03
5	2.38	2.25
10	3.33	2.80
20	4.59	4.45
30	6.14	7.85
40	8.23	13.68

### HV Valve Pressure Loss (psi)

HV Valve Pressure Loss (psi)		METRIC	
Flow (m <sup>3</sup> /h)	Flow (l/s)	1" HV (bar)	1" HV-MB (bar)
0.25	0.06	0.11	0.12
0.75	0.21	0.14	0.14
1.00	0.28	0.16	0.16
2.00	0.56	0.23	0.19
5.00	1.39	0.32	0.31
7.50	2.08	0.42	0.54
9.10	2.52	0.57	0.94

\* Rain Bird recommends flow rates in the supply line not to exceed 7.5 ft/sec (2.3 m/s) in order to reduce the effects of water hammer

### Dimensions

- Height: 4.62" (11.7 cm)
- Height (F): 5.62" (14.3 cm)
- Height (MB): 4.50" (11.4 cm)
- Length: 4.4" (11.2 cm)
- Length (MB): 5.68" (14.4 cm)
- Width: 3.1" (7.9 cm)

### Models

- 100-HV-NPT: 1" (26/34) NPT female x female\*
- 100-HV-SS: 1" (26/34) slip x slip
- 100 HV-MB: 1" (26/34) male x barb
- 100 HVF: 1" (26/34) NPT female x female\*
- 100 HVF-SS: 1" (26/34) slip x slip

\*Available with BSP threads

### Recommendations

1. Rain Bird recommends flow rates that result in discharge velocities in the supply line not to exceed 7.5 ft/sec (2.3 m/s) in order to reduce the effects of water hammer.
2. Rain Bird residential valves cannot be used with PRS pressure regulating modules.
3. Not recommended for use with two-wire systems.

### How To Specify

100 - HV - SS

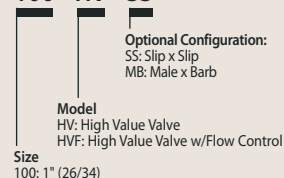

Note: For non-U.S. applications it is necessary to specify NPT or BSP thread type (1" only)

## PGA Series

Plastic Globe and Angle Valves. The Toughest, Most Reliable Valves In their Class

### Features

- Water-tight seal between the body and bonnet for maximum confidence, even in the most extreme conditions
- Robust construction and electrical design for quiet performance you can count on
- Filtered pilot flow to resist debris and clogging
- Slow closing to prevent water hammer and subsequent system damage
- Normally closed, forward flow design Accepts latching solenoid for use with Rain Bird battery-operated controllers
- Multi-drive screws (Phillips, flathead, hexagonal) for easy maintenance\*
- Manual internal bleed operates the valve without allowing water into the valve box. This allows the pressure regulator to be adjusted without turning the valve on at the controller
- One-piece solenoid design with captured plunger and spring for easy servicing. Prevents loss of parts during field service
- Three-year trade warranty
- Accommodates optional, field-installed PRS-D pressure regulating dial to ensure optimum sprinkler performance
- Accepts latching solenoid for use with Rain Bird battery-operated controllers
- Optional purple flow control handle for non-potable water applications PGA-NP-HAN1 (1" and 1 1/2"); PGA-NP-HAN2 (2")



### Extreme Durability

The PGA valve maintains a strong, worry-free seal between the body and bonnet, no matter the conditions. PGA valves were exposed to extreme temperature swings and intense pressures. The result—zero leaks.\*



### Pressure-Resistant Seal

The PGA valve's body-to-bonnet seal is built to overcome the intense water pressure typical of many commercial sites. Faced with repeated pressure surges well into the triple digits, our valves outlasted the nearest competitor more than 2 1/2 times to 1.\*

\* Based on 2013 testing conducted at Rain Bird's Product Research Facility in Tucson, AZ.

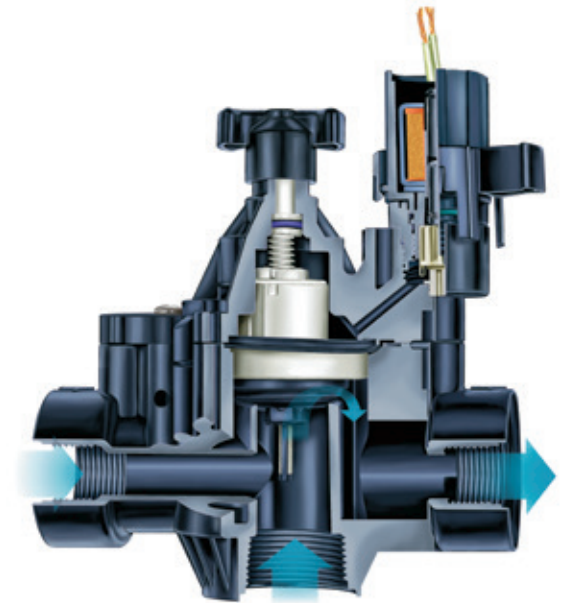

PGA Cutaway



150-PGA

### How To Specify

#### 100 - PGA - PRS-D

Model PGA	Optional Feature PRS-Dial: pressure regulating module (must be ordered separately)
Size 100: 1" (26/34) 150: 1 1/2" (40/49) 200: 2" (50/60)	

Note: Valve and PRS-Dial module must be ordered separately. For non-U.S. applications, it is necessary to specify NPT or BSP thread type.

## PGA Series (cont.)

### Options

- Accommodates optional, field installed PRS-D pressure regulating module to ensure optimum sprinkler performance. Regulates up to 100 psi (6.9 bar)
- Accepts latching solenoid for use with Rain Bird battery-operated controllers up to 150 psi (10,35 bar)
- Compatible with ESP-LXD decoders

### Specifications

- Pressure: 15 to 150 psi (1.04 to 10.4 bar)
- Flow without PRS-D option: 2 to 150 gpm (0.45 to 34.05 m<sup>3</sup>/h; 7.8 to 568 l/m)
- Flow with PRS-D option: 5 to 150 gpm (1.14 to 34.05 m<sup>3</sup>/h; 19.2 to 568 l/m)
- Water temperature: Up to 110° F (43° C) - refer to chart
- Ambient temperature: Up to 125° F (52° C)
- 24VAC 50/60Hz (cycles/sec) solenoid power requirement
- Inrush current: 0.41A (9.9VA) at 60Hz
- Holding current: 0.14A (3.43VA) at 60Hz
- Solenoid coil resistance: 30-39 Ohms, nominal

### Dimensions

Model	Height	Length	Width
• 100-PGA	7 ¼" (18.4 cm)	5 ½" (14.0 cm)	3 ¼" (8.3 cm)
• 150-PGA	8" (20.3 cm)	6 ¾" (17.2 cm)	3 ½" (8.9 cm)
• 200-PGA:	10" (25.4 cm)	7 ¾" (19.7 cm)	5" (12.7 cm)

*Note: PRS-Dial adds 2" (5.1 cm) to valve height*

### Models

- 100-PGA: 1" (26/34)
- 150-PGA: 1 ½" (40/49)
- 200-PGA: 2" (50/60)

*BSP threads available; specify when ordering*

### Recommendations

1. Rain Bird recommends flow rates in the supply line not to exceed 7.5 ft/sec (2.29 m/s) in order to reduce the effects of water hammer
2. For flows below 5 gpm (1.14 m<sup>3</sup>/h; 19.2 l/m), Rain Bird recommends use of upstream filtration to prevent debris from collecting below the diaphragm
3. For flows below 10 gpm (2.27 m<sup>3</sup>/h; 37.8 l/m) Rain Bird recommends the flow control stem be turned down two full turns from the fully open position

### PGA Series Valve Pressure Loss (psi)

Flow gpm	100-PGA Globe 1"	100-PGA Angle 1"	150-PGA Globe 1½"	150-PGA Angle 1½"	200-PGA Globe 2"	200-PGA Angle 2"
1	5.1	4.3	-	-	-	-
5	5.5	5.0	-	-	-	-
10	5.9	5.5	-	-	-	-
20	6.0	5.6	-	-	-	-
30	6.4	5.5	1.9	1.3	-	-
40	7.0	7.5	3.2	2.0	1.2	1.0
50	-	-	4.8	3.0	1.5	0.9
75	-	-	11.1	6.5	3.0	1.7
100	-	-	19.2	11.7	5.5	3.0
125	-	-	-	-	8.6	4.8
150	-	-	-	-	12.0	6.5

### PGA Series Valve Pressure Loss (bar)

PGA Series Valve Pressure Loss (bar)							METRIC	
Flow m <sup>3</sup> /h	Flow l/m	100-PGA Globe 2.5 cm	100-PGA Angle 2.5 cm	150-PGA Globe 3.8 cm	150-PGA Angle 3.8 cm	200-PGA Globe 5.1 cm	200-PGA Angle 5.1 cm	
0.23	3.8	0.35	0.30	-	-	-	-	
0.6	10	0.36	0.32	-	-	-	-	
1.2	20	0.38	0.35	-	-	-	-	
3	50	0.41	0.38	-	-	-	-	
6	100	0.43	0.38	0.10	0.07	-	-	
9	150	0.48	0.51	0.22	0.14	0.08	0.07	
12	200	-	-	0.38	0.23	0.12	0.07	
15	250	-	-	0.61	0.36	0.17	0.10	
18	300	-	-	0.86	0.51	0.24	0.13	
21	350	-	-	1.16	0.70	0.33	0.18	
24	400	-	-	-	-	0.43	0.23	
27	450	-	-	-	-	0.54	0.30	
30	500	-	-	-	-	0.66	0.36	
34	568	-	-	-	-	0.83	0.45	

### PGA Series Temperature Rating

Water Temperature	Continuous Pressure
73° F	150 psi
80° F	132 psi
90° F	112 psi
100° F	93 psi
110° F	75 psi

### PGA Series Temperature Rating

PGA Series Temperature Rating		METRIC
Water Temperature	Continuous Pressure	
23° C	10.4 bar	
27° C	9.1 bar	
32° C	7.7 bar	
38° C	6.4 bar	
43° C	5.2 bar	



## PEB / PESB Series

Best-in-class Professional Series Plastic Irrigation Valves

### Features

- Durable glass-filled nylon construction with fabric-reinforced rubber diaphragm for long life and reliable performance
- Globe configuration
- Normally closed, forward flow design
- Slow closing to prevent water hammer and subsequent system damage
- Low flow capability for a wide range of applications
- One-piece solenoid design with captured plunger and spring for easy servicing. Prevents loss of parts during field service
- Flow control handle adjusts water flows as needed
- Manual internal bleed manually operates the valve without allowing water into the valve box; allows pressure regulator to be adjusted without turning the valve on at the controller first
- Manual external bleed permits flushing debris from the system. Recommended for system start up and after repairs
- Stainless steel studs molded into the body. Bonnet can be attached and removed more easily and more often without damaging threads
- Nylon scrubber scrapes a stainless steel screen to clean and break down grit and plant material. Prevents debris build-up and clogging (PESB Series only)
- Five-year trade warranty

### Specifications

- Pressure: 20 to 200 psi (1,4 to 13,8 bar)
- Flow without PRS-D option: 0.25 to 200 GPM (0,06 to 45 m<sup>3</sup>/h; 0,02 to 12,60 l/s)
- Flow with PRS-D option: 5 to 200 GPM (1,14 to 45 m<sup>3</sup>/h; 0,32 to 12,60 l/s)
- Temperature: Up to 150° F (66° C)
- 24VAC 50/60Hz (cycles/sec) solenoid power requirement
- Inrush current: 0.41A (9.9VA) at 60Hz
- Holding current: 0.14A (3.43VA) at 60Hz
- Solenoid coil resistance: 30-39 Ohms, nominal

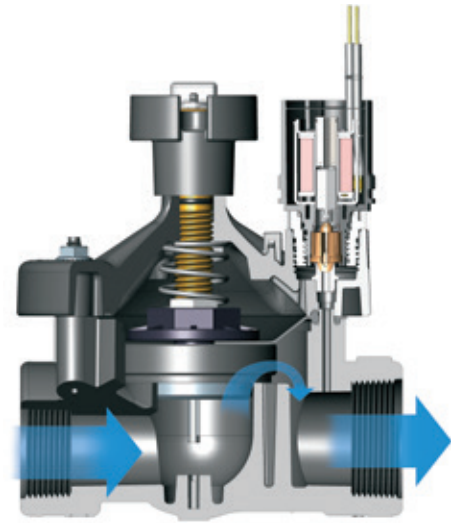

PEB Cutaway

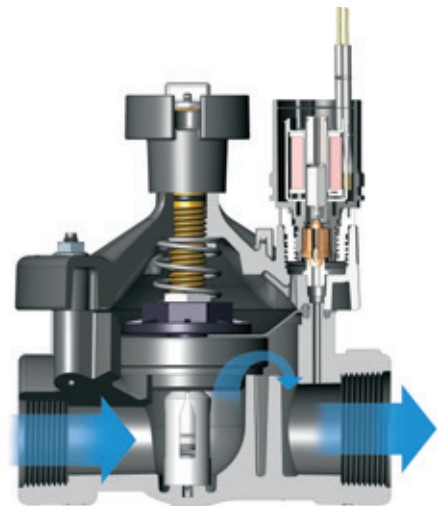

PESB Cutaway



150-PEB



150-PESB

### How To Specify

100 - PEB - PRS-D

Size  
100: 1" (26/34)  
150: 1½" (40/49)  
200: 2" (50/60)

Model  
PEB

Optional Feature  
PRS-Dial: pressure  
regulating module  
(must be ordered  
separately)

Note: Valve and PRS-Dial module must be ordered separately. For non-U.S. applications, it is necessary to specify NPT or BSP thread type.

## PEB / PESB Series (cont.)

### Options

- Accommodates optional, field installed PRS-D pressure regulating module to ensure optimum sprinkler performance. Regulates up to 100 psi (6.9 bar)
- Accepts latching solenoid for use with Rain Bird battery-operated controllers up to 150 psi (10,35 bar)
- Compatible with ESP-LXD decoders
- Optional purple flow control handle for non-potable water applications PEB-NP-HAN1 (1"); PEB-NP-HAN2 (1 1/2" and 2")

### Dimensions

Model	Height	Length	Width
• 100-PEB and 100-PESB:	6½" (16.5 cm)	4" (10.2 cm)	4" (10.2 cm)
• 150-PEB and 150-PESB:	8" (20.3 cm)	6" (15.2 cm)	6" (15.2 cm)
• 200-PEB and 200-PESB:	8" (20.3 cm)	6" (15.2 cm)	6" (15.2 cm)

**Note:** The PRS-Dial option adds 2" (5.1 cm) to valve height

### Models

- 100-PEB and 100-PESB: 1" (26/34)
- 150-PEB and 150-PESB: 1½" (40/49)
- 200-PEB and 200-PESB: 2" (50/60)

BSP threads available; specify when ordering

### Recommendations

1. Rain Bird recommends flow rates in the supply line not to exceed 7.5 ft/sec (2.29 m/s) in order to reduce the effects of water hammer
2. For flows below 5 gpm (1.14 m³/h; 19.2 l/m), Rain Bird recommends use of upstream filtration to prevent debris from collecting below the diaphragm
3. For flows below 10 gpm (2.27 m³/h; 37.8 l/m) Rain Bird recommends the flow control stem be turned down two full turns from the fully open position
4. For PRS-Dial applications, Rain Bird recommends the installation of a pressure-regulating master valve or inline pressure regulator when the inlet pressure exceeds 100 psi (6.9 bar)

### PEB and PESB Series Valve Pressure Loss (psi)

Flow gpm	100-PEB 1"	150-PEB 1½"	200-PEB 2"
0.25	0.8	-	-
0.5	1.0	-	-
1	1.3	-	-
5	1.7	-	-
10	1.8	-	-
20	2.9	3.9	-
30	5.6	3.6	-
40	10.0	3.5	-
50	15.6	3.6	4.8
75	-	5.4	4.5
100	-	9.6	5.2
125	-	14.6	8.2
150	-	21.2	11.8
175	-	-	15.5
200	-	-	19.5

### PEB and PESB Series Valve Pressure Loss (bar) METRIC

Flow m³/h	Flow l/m	100-PEB 2.5 cm	150-PEB 3.8 cm	200-PEB 5.1 cm
0.06	1	0.06	-	-
0.3	5	0.09	-	-
0.6	10	0.10	-	-
1.2	20	0.12	-	-
3	50	0.15	-	-
6	100	0.32	0.26	-
9	150	0.68	0.24	-
12	200	-	0.26	0.33
15	250	-	0.33	0.32
18	300	-	0.42	0.32
21	350	-	0.57	0.34
24	400	-	0.74	0.41
27	450	-	0.92	0.51
30	500	-	1.14	0.64
33	550	-	1.38	0.77
36	600	-	-	0.90
39	650	-	-	1.04
42	700	-	-	1.18
45	757	-	-	1.34

### Notes

1. Loss values are with flow control fully open
2. PRS-Dial recommended for use in shaded area only

## PESB-R Series Valves

Durable Plastic – chlorine resistant Professional Plastic Irrigation Valves for reclaimed water irrigation applications

### Features

- Plastic diaphragm and scrubber components molded of chlorine- and chemical-resistant plastic material
- Durable glass-filled nylon construction for long life and heavy-duty performance at 200 psi (13,80 bars) pressure
- Stainless steel studs molded into the body. Bonnet can be attached and removed easily without damaging threads
- One-piece solenoid design with captured plunger and spring for easy servicing. Prevents loss of parts during field service
- External bleed protects the solenoid ports from debris when system is flushed
- Internal bleed operates the valve without allowing water into the valve box; allows pressure regulator to be adjusted without turning on the valve at the controller first
- Slow closing to prevent water hammer and subsequent system damage
- Scrubber mechanism scrapes stainless steel screen clean to break down grit and plant material
- Purple flow control handle standard on PESB-R Series valves
- Five-year trade warranty

### Options

- Accommodates optional, field installed PRS-D pressure regulating module to ensure optimum sprinkler performance. Regulates up to 100 psi (6.9 bar)
- Accepts latching solenoid for use with Rain Bird battery-operated controllers up to 150 psi (10,35 bar)
- Compatible with ESP-LXD decoders

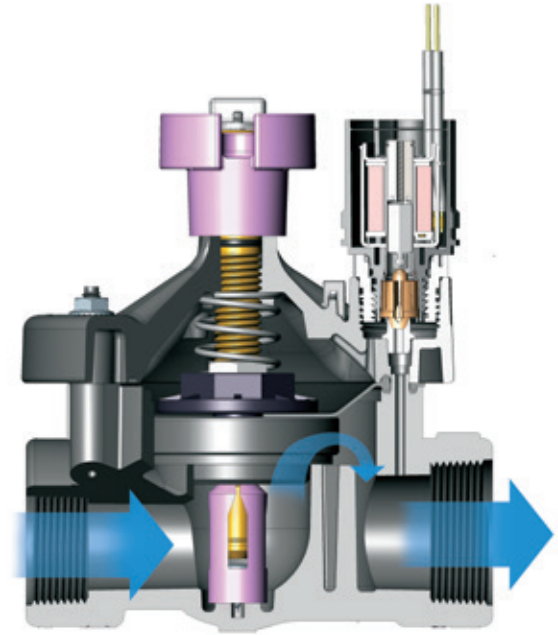

PESB-R Cutaway

150-PESB-R



### How To Specify

#### 100 - PESBR - PRS-D

Size	Model	Optional Feature
100: 1" (26/34)	PESB-R: scrubber model	PRS-Dial: pressure regulating module (must be ordered separately)
150: 1½" (40/49)		
200: 2" (50/60)		

Note: Valve and PRS-Dial module must be ordered separately.

## PESB-R Series (cont.)

### Specifications

- Pressure: 20 to 200 psi (1.38 to 13.80 bar)
- Flow: 0.25 to 200 gpm (0.06 to 45.40 m<sup>3</sup>/h; 0,02 to 12,60 l/s)
- Flow with PRS-Dial: 5 to 200 gpm (1.14 to 45.40 m<sup>3</sup>/h; 0,32 to 12,60 l/s)
- Temperature: Up to 150° F (66° C)
- 24VAC 50/60Hz (cycles/sec) solenoid power requirement
- Inrush current: 0.41A (9.9VA) at 60Hz
- Holding current: 0.14A (3.43VA) at 60Hz
- Solenoid coil resistance: 30-39 Ohms, nominal

### Dimensions

Model	Height	Length	Width
• 100-PESB-R	6½" (16.5 cm)	4" (10.2 cm)	4" (10.2 cm)
• 150-PESB-R	8" (20.3 cm)	6" (15.2 cm)	6" (15.2 cm)
• 200-PESB-R	8" (20.3 cm)	6" (15.2 cm)	6" (15.2 cm)

Note: The PRS-Dial option adds 2" (5.1 cm) to valve height

### Models

- 100-PESB-R: 1" (26/34)
- 150-PESB-R: 1½" (40/49)
- 200-PESB-R: 2" (50/60)

BSP threads available, specify when ordering

### Recommendations

1. Rain Bird recommends flow rates in the supply line not to exceed 7.5 ft/sec (2.29 m/s) in order to reduce the effects of water hammer
2. For flows below 5 gpm (1.14 m<sup>3</sup>/h; 19.21 l/m), Rain Bird recommends use of upstream filtration to prevent debris from collecting below the diaphragm
3. For flows below 10 gpm (2.27 m<sup>3</sup>/h; 37.8 l/m) Rain Bird recommends the flow control stem be turned down two full turns from the fully open position

PESB-R Series Valve Pressure Loss (psi)			
Flow gpm	100-PESB-R 1"	150-PESB-R 1½"	200-PESB-R 2"
0.25	1.6	-	-
0.5	3.0	-	-
1	1.8	-	-
5	2.9	-	-
10	2.9	-	-
20	2.6	3.5	-
30	5.8	3.1	-
40	10.2	2.3	-
50	16.0	2.1	3.7
75	-	4.3	3.3
100	-	7.5	4.7
125	-	11.9	8.6
150	-	17.0	12.6
175	-	-	14.8
200	-	-	18.9

PESB-R Series Valve Pressure Loss (bar)				METRIC
Flow m <sup>3</sup> /h	Flow l/m	100-PESB-R 2.5 cm	150-PESB-R 3.8 cm	200-PESB-R 5.1 cm
0.06	1	0.11	-	-
0.3	5	0.13	-	-
0.6	10	0.15	-	-
1.2	20	0.20	-	-
3	50	0.19	-	-
6	100	0.32	0.22	-
9	150	0.69	0.16	-
12	200	-	0.16	0.25
15	250	-	0.24	0.24
18	300	-	0.33	0.25
21	350	-	0.45	0.30
24	400	-	0.59	0.38
27	450	-	0.75	0.53
30	500	-	0.91	0.67
33	550	-	1.10	0.82
36	600	-	-	0.92
39	650	-	-	1.00
42	700	-	-	1.13
45	757	-	-	1.30

### Notes

1. Loss values are with flow control fully open
2. PRS-Dial recommended for use in shaded area only

## EFB-CP Series Brass Valves

Highly durable Brass Irrigation Valves - Globe Configuration

### Features

- Reliable performance even in dirty water applications. Self-flushing filter resists debris build-up
- Rugged red brass construction for longer life
- Durable, fabric-reinforced diaphragm composed of EPDM, a rubber material which is chlorine and chemical resistant
- Normally closed, reverse flow design ensures valve will fail in the closed position if a tear or rip in the diaphragm occurs. Prevents flooding, water waste and landscape damage
- Slow closing to prevent water hammer and subsequent system damage
- One-piece solenoid design with captured plunger and spring for easy servicing. Prevents loss of parts during field service
- Manual internal bleed operates the valve without allowing water into the valve box. Allows pressure regulator adjustment without turning on the controller
- Manual external bleed permits flushing debris from the system. Recommended for system start up and other repairs
- Contamination-proof, self-flushing filter screen resists debris build-up. Water flow continuously flushes the screen, dislodging particles and debris before they can accumulate and clog the filter
- Reclaimed water compatible: all models now feature EPDM diaphragms and chlorine-resistant parts as standard equipment
- Three-year trade warranty

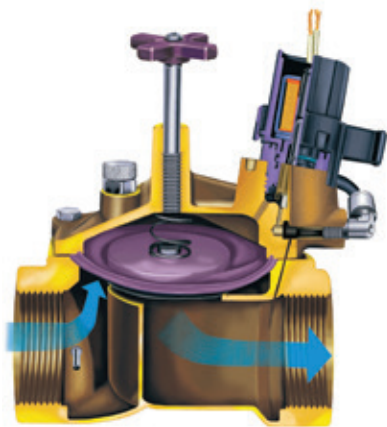

EFB-CP Cutaway

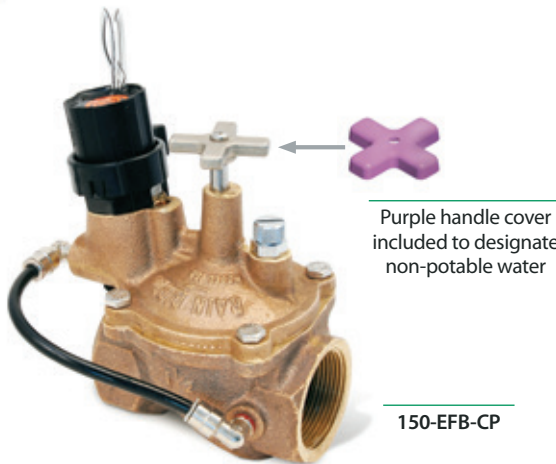

Purple handle cover included to designate non-potable water

150-EFB-CP

### Options

- Accommodates optional, field installed PRS-D pressure regulating module to ensure optimum sprinkler performance. Regulates up to 100 psi (6.9 bar)
- Accepts latching solenoid for use with Rain Bird battery-operated controllers up to 150 psi (10,35 bar)
- Compatible with ESP-LXD decoders

### Specifications

- Pressure: 15 to 200 psi (1,04 to 13,80 bar)
- Flow with/without PRS-D: 5 to 200 GPM (1.14 to 45,40 m<sup>3</sup>/h; 0,32 to 12,60 l/s)
- Temperature: up to 150° F (66° C)
- 24VAC 50/60Hz (cycles/sec) solenoid power requirement
- Inrush current: 0.41A (9.9VA) at 60Hz
- Holding current: 0.14A (3.43VA) at 60Hz
- Solenoid coil resistance: 30-39 Ohms, nominal

### Dimensions

Model	Height	Length	Width
• 100-EFB-CP:	6" (15.2 cm)	4½" (11.4 cm)	3¼" (8.3 cm)
• 150-EFB-CP:	6½" (16.5 cm)	5½" (14 cm)	4½" (11.4 cm)
• 200-EFB-CP:	7" (17.8 cm)	6¾" (17.1 cm)	5¾" (14.6 cm)

**Note:** The PRS-Dial option adds 2" (5.1 cm) to the valve height

### Models

- 100-EFB-CP: 1" (26/34)\*
- 150-EFB-CP: 1½" (40/49)\*
- 200-EFB-CP: 2" (50/60)\*

\* BSP threads available; specify when ordering

### Recommendations

1. Rain Bird recommends flow rates in the supply line not to exceed 7.5 ft/sec (2.29 m/s) in order to reduce the effects of water hammer
2. For flows below 5 gpm (1.14 m<sup>3</sup>/h; 19.21 l/m), Rain Bird recommends use of upstream filtration to prevent debris from collecting below the diaphragm
3. For flows below 10 gpm (2.27 m<sup>3</sup>/h; 37.8 l/m) Rain Bird recommends the flow control stem be turned down two full turns from the fully open position

### How To Specify

#### 100 - EFB-CP - PRS-D

Size  
100: 1"  
150: 1½"  
200: 2"

Model  
EFB-CP

Optional Feature  
PRS-Dial: pressure regulating module (must be ordered separately)

**Note:** Valve and PRS-Dial module must be ordered separately.

## EFB-CP Series (cont.)

EFB-CP Series Valve Pressure Loss (psi)			
Flow gpm	100 EFB-CP 1"	150 EFB-CP 1½"	200 EFB-CP 2"
5	0.2	-	-
10	0.7	-	-
15	1.2	-	-
20	2.1	2.3	0.5
30	5	2.9	0.6
40	8.2	2	0.8
50	13	3.3	1.1
60	-	4.6	1.8
80	-	7.5	2.4
100	-	11.8	3.8
120	-	16.6	5.9
140	-	-	7.8
160	-	-	10
180	-	-	12.5
200	-	-	15.8

EFB-CP Series Valve Pressure Loss (bar)				METRIC
Flow m³/h	Flow l/m	100 EFB-CP 2.5 cm	150 EFB-CP 3.8 cm	200 EFB-CP 5.1 cm
1	19	0.01	-	-
3	50	0.07	-	-
6	100	0.27	0.19	0.04
9	150	0.56	0.14	0.05
12	200	-	0.25	0.09
15	250	-	0.38	0.14
18	300	-	0.51	0.16
21	350	-	0.70	0.23
24	400	-	0.91	0.30
27	450	-	1.13	0.40
30	500	-	-	0.49
33	550	-	-	0.58
36	600	-	-	0.68
39	650	-	-	0.79
42	700	-	-	0.92
45	757	-	-	1.09

**Notes**

1. Loss values are with flow control fully open
2. PRS-Dial module recommended for all flow rates

## 300-BPES Brass Valves

3" Brass Master Valve - Globe and angle configuration

**Features**

- Unique hybrid construction featuring durable red brass body and glass-filled nylon bonnet for long life at a value price
- Normally closed, forward flow design
- Slow closing to prevent water hammer and subsequent system damage
- Robust solenoid provides dependable performance even during constant operation
- Flow control handle adjusts water flows as needed and incorporates a brass thread insert for longer life
- Manual internal bleed operates the valve without allowing water into the valve box. Allows pressure regulator adjustment without turning the valve on at the controller
- Manual external bleed permits flushing debris from the system. Recommended for system start up and repairs
- Highly efficient operation with extremely low pressure loss
- Patented nylon scrubber scrapes a stainless steel screen to clean and break down grit and plant material. Prevents debris build-up and clogging
- Three-year trade warranty

**Options**

- Accommodates field-installed PRS-D pressure regulating module to ensure optimum sprinkler performance
- Purple flow control handle for non-potable water applications (BPE-NP-HAN)
- Latching solenoid for use with Rain Bird battery-operated controllers up to 150 psi (10,4 bar)

**Specifications**

- Pressure: 20 to 200 psi (1,4 to 13,8 bar)
- Flow with/without PRS-D option: 60 to 300 gpm (13,6 to 68,1 m³/h; 3,78 to 18,90 l/s)
- Temperature: up to 140° F (60° C)
- Power: 24 VAC 50/60 Hz (cycles per second) solenoid
- Inrush current: 0.41 A (9.8 VA) at 60Hz
- Holding current: 0.28 A (6.7 VA) at 60Hz
- Coil resistance: 28 Ohms, nominal

**How To Specify**

**300 - BPES - PRS-D**

Model  
BPES

Optional Feature  
PRS-Dial: pressure  
regulating module  
(must be ordered  
separately)

Size  
3" (80/90)

Note: Valve and PRS-Dial module must be ordered separately. For non-U.S. applications, it is necessary to specify NPT or BSP thread type.



300-BPES

BPES 3" Valve Pressure Loss (psi)		
Flow gpm	Globe	Angle
60	6.6	6.8
80	5.1	5.9
100	3.2	3.5
120	1.8	1.8
140	1.8	2.1
160	2.0	2.1
180	2.2	2.0
200	2.7	2.5
250	4.0	3.4
300	4.9	4.5

BPES 3" Valve Pressure Loss (bar)			METRIC
Flow m <sup>3</sup> /h	Flow l/m	Globe	Angle
13.6	227	0.46	0.47
24	400	0.19	0.21
36	600	0.14	0.14
48	800	0.21	0.19
60	1000	0.29	0.26
68	1136	0.34	0.31

**Notes**

1. Loss values are with flow control fully open
2. PRS-Dial module recommended for all flow rates

**Dimensions**

Model	Height	Length	Width
• 300	13 <sup>5</sup> / <sub>8</sub> " (34.61 cm)	8" (20.32 cm)	7" (17.78 cm)

**Models**

- 300-BPES: 3" (80/90)
- BSP threads available; specify when ordering

**Recommendations**

1. Rain Bird recommends flow rates in the supply line not to exceed 7.5 ft/sec (2.29 m/s) in order to reduce the effects of water hammer
2. For flows below 5 gpm (1.14 m<sup>3</sup>/h; 19.2 l/m), Rain Bird recommends use of upstream filtration to prevent debris from collecting below the diaphragm.
3. For flows below 10 gpm (2.27 m<sup>3</sup>/h; 37.8 l/m) Rain Bird recommends the flow control stem be turned down two full turns from the fully open position.

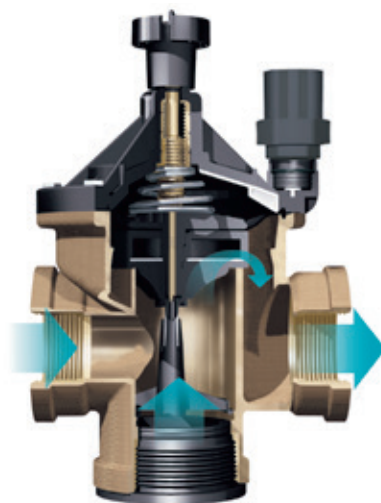

BPES Cutaway

**DB Series Wire Connector**

Connections Made Easy

**Features and Benefits**

- Install Faster – the DB Series Wire Connector is quick to install and provides reliable moisture sealing for controller and valve electrical connections you can count on
- Simplify Inventory – This is the only wire connector you'll need! It is ideal for use on two wire decoder control systems
- Avoid Call Backs – Locating and repairing a corroded wire splice costs your business time and money. Avoid unnecessary service call backs
- Use for standard controllers, valve boxes and soil moisture sensors
- Wire combinations ranging from 22ga to 8ga
- Use on connections from 24 VAC to 600 VAC
- UL 486D certified for direct burial
- The Strain Relief ensures wires are secure and won't pull apart
- Waterproof silicone sealant protects against corrosion
- UV-resistant material ensures product performance does not degrade even after long periods of exposure to sunlight

**Models**

- DBRY20: Direct Bury Silicone Tube, Red Yellow Wire Nut, Bag of 20



DBRY20

**Wire Combinations (for solid and stranded wire)**

DBRY20	
2-3 #10	2#18
2-5 #12	1 #8 w/2 #18
2-5 #14	3 #10 w/1 #18
4-6 #16	3 #12 w/3 #18
3 #14 w/2 #18	

The combinations listed are only a sample of the most common wire combinations.

## PRS-Dial

Pressure Regulating Module

### Features

- The PRS-Dial is an excellent means of regulating outlet pressure at the valve regardless of incoming pressure fluctuations. The visible scale makes adjustment quick and easy. The regulator fits all Rain Bird PGA, PEB, PESB, PESB-R, EFB-CP, and BPES series valves
- Regulates and maintains constant outlet pressure between 15 and 100 psi (1.04 to 6.9 bar) within  $\pm 3$  psi ( $\pm 0.21$  bar)
- Adjustment knob with detents permits fine-tune setting in 1/3 psi (0.02 bar) increments. Dial cartridge makes installation and adjustment quick, easy and accurate Improved spike reduction capabilities reduce water hammer
- Ergonomic design with snap-tight cover to prevent vandalism
- Waterproof dial cartridge eliminates fogging and binding
- Dial cartridge retrofits into all existing PRS-D units
- Schrader valve connects pressure hose gauge, ordered separately
- Easy field installation. PRS-Dial threads underneath the solenoid and adapter
- Corrosion-resistant glass-filled nylon for rugged performance

### Operating Range

- Pressure: Up to 100 psi (6.9 bar)\*
- Regulation: 15 to 100 psi (1.04 to 6.9 bar)
- Flow: Refer to chart

\* While the PRS-Dial unit can withstand pressures up to 200 psi (13.8 bar), accurate pressure regulation can be maintained only up to 100 psi (6.9 bar)

### Model

- PRS-D

### Application Information

- Proper operation requires inlet pressure to be a minimum of 15 psi (1.04 bar) higher than desired outlet pressure
- For areas with very high pressure or uneven terrain, install sprinklers with PRS pressure regulating stems and/or SAM check valves
- When inlet pressure exceeds 100 psi (6.9 bar), a pressure regulating master valve or inline pressure regulator is required
- Rain Bird does not recommend using the pressure regulating module for applications outside the recommended flow ranges
- To reduce the effects of water hammer, Rain Bird recommends flow rates in the supply line not to exceed 7.5 ft/sec (2.29 m/s)
- For flows below 10 gpm (2.27 m<sup>3</sup>/h; 37.8 l/m), Rain Bird recommends the flow control stem be turned down two full turns from the fully open position

† Note: Valve and PRS-Dial module must be ordered separately.

### Valve Flow Ranges\*

Model	gpm	m <sup>3</sup> /h	l/m
100-PGA	5-40	1.14-9.08	19.2-151
150-PGA	30-100	6.81-22.70	113-378
200-PGA	40-150	9.08-34.05	151-568
100-PEB	5-50	1.14-11.35	19.2-189
150-PEB	20-150	4.54-34.05	76-568
200-PEB	75-200	17.03-45.40	284-757
100-PESB/PESB-R	5-50	1.14-11.35	19.2-189
150-PESB/PESB-R	20-150	4.54-34.05	76-568
200-PESB/PESB-R	75-200	17.03-45.40	284-757
100-EFB-CP	5-50	1.14-11.35	19.2-189
125-EFB-CP	20-80	4.54-18.16	76-302
150-EFB-CP	20-120	4.54-31.78	76-529
200-EFB-CP	20-200	4.54-45.40	76-757
300-BPES	60-300	13.62-68.10	227-1136

\* These are the valve flow ranges. The PRS-Dial regulates only up to 100 psi (6.9 bar)





## Quick-Coupling Valves

Convenient water access in potable and non-potable systems

### Features

- Optional locking cover on models 33-DLRC, 44-LRC, 5-LRC, 33-DNP, 44-NP, and 5-NP (use 2049 key to unlock). Metal cover on model 7 only
- One-piece body design (models 3-RC, 5-RC and 7)
- Two-piece body design for easy servicing (models 33-DRC, 44-LRC, 44-RC, 33-DNP, and 44-NP)
- Strong corrosion-resistant stainless steel spring prevents leakage
- Thermoplastic cover for durability
- 33-DNP, 44-NP, and 5-NP covers marked with "Do Not Drink!" warnings in English and Spanish
- Three-year trade warranty

### Specifications

- Pressure: 5 to 125 psi (0.35 to 8.63 bar)
- Flow: 10 to 125 gpm (2.27 to 28.38 m<sup>3</sup>/h; 37.8 to 473 l/m)
- 33-DNP, 44-NP and 5-NP flow: 10 to 70 gpm (2.27 to 15.89 m<sup>3</sup>/h; 37.8 to 265 l/m)

### Dimensions (height)

- 3-RC: 4<sup>1</sup>/<sub>4</sub>" (10.8 cm)
- 44-RC: 6" (15.2 cm)
- 7: 5<sup>3</sup>/<sub>4</sub>" (14.6 cm)
- 33-DRC: 4<sup>3</sup>/<sub>8</sub>" (11.1 cm)
- 44-LRC: 6" (15.2 cm)
- 33-DNP: 4<sup>3</sup>/<sub>8</sub>" (11.1 cm)
- 33-DLRC: 4<sup>5</sup>/<sub>8</sub>" (11.7 cm)
- 5-RC: 5<sup>1</sup>/<sub>2</sub>" (14.0 cm)
- 44-NP: 6" (15.2 cm)
- 5-LRC: 5<sup>1</sup>/<sub>2</sub>" (14.0 cm)
- 5-NP: 5<sup>1</sup>/<sub>2</sub>" (14.0 cm)

### Models

- 3-RC: 3/4" (20/27) Rubber Cover, 1-Piece Body
- 33-DRC: 3/4" (20/27) Double Track Key Lug, Rubber Cover, 2-Piece Body
- 33-DLRC: 3/4" (20/27) Double Track Key Lug, Locking Rubber Cover, 2-Piece Body
- 44-RC: 1" (26/34) Rubber Cover, 2-Piece Body
- 44-LRC: 1" (26/34) Locking Rubber Cover, 2-Piece Body
- 5-RC: 1" (26/34) Rubber Cover, 1-Piece Body
- 5-LRC: 1" (26/34) Locking Rubber Cover, 1-Piece Body
- 7: 1 1/2" (40/49) Metal Cover, 1-Piece Body
- 5-RC-BSP: 1" (26/34) Rubber Cover, 1-Piece Body, BSP threaded
- 5-LRC-BSP: 1" (26/34) Locking Rubber Cover, 1-Piece Body, BSP threaded
- 33-DNP: 3/4" (20/27) Non-potable, Purple Locking Rubber Cover, 2-Piece Body
- 44-NP: 1" (26/34) Non-potable, Purple Locking Rubber Cover, 2-Piece Body
- 5-NP: 1" (26/34) Non-potable, Purple Locking Rubber Cover, 1-Piece Body

**Note:** For non-US applications, it is necessary to specify NPT or BSP thread type

### Quick-Coupling Valves Pressure Loss (psi)

Flow	3-RC	33-DRC 33-DLRC 33-DNP	44-RC 44-LRC 44-NP	5-RC 5-LRC 5-NP	7
gpm	3/4"	3/4"	1"	1"	1 1/2"
10	1.8	2	-	-	-
15	4.7	4.3	2.2	-	-
20	7.2	7.6	4.4	-	-
30	-	-	11.5	4.1	-
40	-	-	-	7.3	-
50	-	-	-	11	1.7
60	-	-	-	15.7	2.5
70	-	-	-	21.5	3.6
80	-	-	-	-	4.9
100	-	-	-	-	8.4
125	-	-	-	-	14

### Quick-Coupling Valves Pressure Loss (bar)

Flow		3-RC	33-DRC 33-DLRC 33-DNP	44-RC 44-LRC 44-NP	5-RC 5-LRC 5-NP	7	METRIC
m <sup>3</sup> /h	l/m	1.9 cm	1.9 cm	2.5 cm	2.5 cm	3.8 cm	
2.3	38	0.12	0.12	-	-	-	
4	67	0.41	0.42	0.23	-	-	
5	83	0.57	0.62	0.40	-	-	
6	100	-	-	0.62	-	-	
7	117	-	-	0.83	0.30	-	
8	133	-	-	-	0.40	-	
9	150	-	-	-	0.50	-	
10	167	-	-	-	0.61	-	
12	200	-	-	-	0.85	0.13	
14	233	-	-	-	1.15	0.18	
16	267	-	-	-	1.50	0.25	
22	367	-	-	-	-	0.54	
28	473	-	-	-	-	0.97	



Quick-Coupling Valve Cutaway



Quick Coupling Valves

## Valve Keys

Quick-Coupling Keys

### Features

- Key threads into top of quick-coupling valve to provide water access

### Models

- 33-DK: 3/4" (20/27)
- 44-K: 1" (26/34)
- 55-K-1: 1" (26/34)\*
- 7-K: 1 1/2" (40/49)\*

\* Available with BSP threads; specify when ordering



55-K-1

### Corresponding Valve Keys

Valve	Key	Top Pipe Threads	
		Male	Female
3-RC	33-DK	3/4"	1/2"
33-DRC/33-NP	33-DK	3/4"	1/2"
44-RC/44-NP	44-K	1"	3/4"
5-RC/5-NP	55-K-1	1"	-
7	7-K	1 1/2"	1 1/4"

### Corresponding Valve Keys

### METRIC

Valve	Key	Top Pipe Threads	
		Male	Female
3-RC	33-DK	20/27	15/21
33-DRC/33-NP	33-DK	20/27	15/21
44-RC/44-NP	44-K	26/34	20/27
5-RC/5-NP	55-K-1	26/34	-
7	7-K	40/49	33/42

## SH Series

Hose Swivel

### Features

- Attaches water hose to quick-coupling valve key
- Swivels up to 360°
- Allows hose to be pulled in any direction
- Prevents hose damage

### Specifications

- SH-0: 3/4" (20/27) female pipe thread x 3/4" (20/27) male hose thread
- SH-1: 1" (26/34) female pipe thread x 3/4" (20/27) male hose thread
- SH-2: 1" (26/34) female pipe thread x 1" (26/34) male hose thread
- SH-3: 1 1/2" (40/49) female pipe thread x 1" (26/34) male hose thread

### Models

- SH-0
- SH-1
- SH-2\*
- SH-3

\*Available with BSP threads



SH-0

## Locking Cover Key

### Features

- Locks and unlocks the optional locking cover on quick-coupling valves
- Operates the valve marker compression lock
- Compatible with models 33-DLRC, 33-DNP, 44-LRC, 44-NP, 5-LRC, and 5-NP

### Model

- 2049 Cover Key



2049

## Purple Valve Handle Assembly

### Features

- Purple flow control handle identifies valve as part of a non-potable system
- Easily field installed
- Sizes for all Rain Bird Commercial Valves

### Models

- PGA-NP-HAN1 (1" and 1 1/2" PGA Valves)
- PGA-NP-HAN2 (2" PGA Valves)
- PEB-NP-HAN1 (1" PEB/PESB Valves)
- PEB-NP-HAN2 (1 1/2" and 2" PEB/PESB Valves)
- BPE-NP-HAN (3" BPE/BPES Valves)

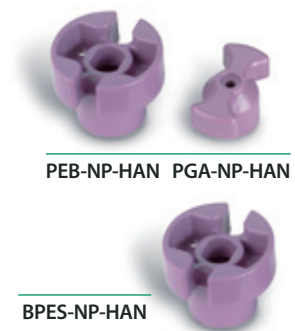

PEB-NP-HAN PGA-NP-HAN

BPES-NP-HAN

## PVB Professional Series Valve Boxes

The PVB Series valve box provides rugged, no-nonsense dependability, with a price tag that can meet any budget

### Features

- Light & durable construction
- Side ridges for additional side wall support
- Pre-molded pipe slots
- Bottom flanges to help prevent sinking
- Four colors: available in green, black, tan and purple
- Multiple configurations designed to provide tight seals and easy maintenance access
- Earth-friendly, LEED-compliant material made of 100% recycled materials (black boxes and black lids only)



6" Round Valve Box	10" Round Valve Box	Mini Standard Valve Box	Standard Valve Box	Standard Extension	Jumbo Valve Box	Jumbo Extension
<b>SIZE</b>						
Top Opening: 6 1/2" diameter Bottom Opening: 8 3/4" diameter	Top Opening: 10" diameter Bottom Opening: 12 1/4" diameter	Top Opening: 15" L x 9 1/2" W Bottom Opening: 18" L x 12 1/2" W x 10" H	Top Opening: 18 1/4" L x 13" W Bottom Opening: 21 1/4" L x 15 1/4" W x 12" H	Top Opening: 17" L x 11 3/4" W Bottom Opening: 18 7/8" L x 13 3/8" W x 6 3/4" H	Top Opening: 22 1/4" L x 16 3/8" W Bottom Opening: 25 1/4" L x 19 3/8" W x 12" H	Top Opening: 21 3/8" L x 15 7/8" W Bottom Opening: 22 1/8" L x 16 3/8" W x 6 3/8" H
<b>ADDITIONAL FEATURES</b>						
<ul style="list-style-type: none"> <li>• Snap-in overlapping lid</li> <li>• Skid-resistant texture</li> <li>• Body built with three ridges for additional sidewall support</li> </ul>	<ul style="list-style-type: none"> <li>• Overlapping lid with bolt hole and twist lock</li> <li>• Skid-resistant lid texture</li> <li>• Body built with double ridges for additional sidewall support</li> </ul>	<ul style="list-style-type: none"> <li>• Our compact alternative to a standard size box</li> <li>• Drop-in lid</li> <li>• Skid-resistant lid texture</li> </ul>	<ul style="list-style-type: none"> <li>• Drop-in lockable lid</li> <li>• Skid-resistant lid texture</li> <li>• Double ledge lid support</li> <li>• Ridge adds additional support to sidewalls</li> </ul>	<ul style="list-style-type: none"> <li>• Overlapping lockable lid</li> <li>• Skid-resistant lid texture</li> <li>• Body can be used to extend the PVB Standard series</li> <li>• Body can be used as a 6" deep box</li> </ul>	<ul style="list-style-type: none"> <li>• Drop-in lockable lid</li> <li>• Skid-resistant lid texture</li> <li>• Double ledge lid support</li> <li>• Ridge adds additional support to sidewalls</li> </ul>	<ul style="list-style-type: none"> <li>• Overlapping lockable lid</li> <li>• Skid-resistant lid texture</li> <li>• Body can be used to extend the PVB Jumbo series</li> <li>• Body can be used as a 6" deep box</li> </ul>
<b>MODELS</b>						
<ul style="list-style-type: none"> <li>• PVB6RND: 6" round black body &amp; overlapping green lid</li> <li>• PVB6RNDP: 6" round black body &amp; overlapping purple lid</li> <li>• PVB6RNDT: 6" round black body &amp; overlapping tan lid</li> </ul>	<ul style="list-style-type: none"> <li>• PVB10RND: 10" round black body &amp; overlapping green lid</li> <li>• PVB10RNDP: 10" round purple body &amp; overlapping purple lid</li> <li>• PVB10RNDT: 10" round tan body &amp; overlapping tan lid</li> </ul>	<ul style="list-style-type: none"> <li>• PVBMS: 10" mini-standard black body &amp; drop-in green lid</li> </ul>	<ul style="list-style-type: none"> <li>• PVBSTD: 12" standard black body &amp; drop-in green lid</li> <li>• PVBSTDP: 12" standard purple body &amp; drop-in purple lid</li> <li>• PVBSTDT: 12" standard tan body &amp; drop-in tan lid</li> </ul>	<ul style="list-style-type: none"> <li>• STDEXT body can extend the Standard Valve box by 6" in height</li> <li>• STDEXT body can be used as a 6" deep box to reduce digging</li> <li>• PVBSTDEXT: 6" black body &amp; overlapping green lid</li> <li>• PVBSTDEXTT: 6" tan body &amp; overlapping tan lid</li> </ul>	<ul style="list-style-type: none"> <li>• PVBJMB: 12" black body &amp; drop-in green lid</li> <li>• PVBJMBP: 12" purple body &amp; drop-in purple lid</li> <li>• PVBJMBT: 12" tan body &amp; drop-in tan lid</li> </ul>	<ul style="list-style-type: none"> <li>• PVBJBEXT: 6" black body &amp; overlapping green lid</li> <li>• PVBJBEXTP: 6" purple body &amp; overlapping purple lid</li> <li>• PVBJBEXTT: 6" tan body &amp; overlapping tan lid</li> </ul>

**6" Round Lids**

PVB6RNDGL:  
6" round green lid

**10" Round Lids**

PVB10RNDGL:  
10" round green lid

**12" Standard Lids**

PVBSTDGL:  
12" standard green lid

**12" Jumbo Lids**

PVBJMBGL:  
12" jumbo green lid

Valves

### VB Series Valve Boxes

Commercial grade boxes that are loaded with a rich set of industry-leading features

#### Features

- **Strength and Stability** – Multiple sizes and shapes are designed with corrugated sides and wide flange bases for maximum durability, compression strength, and stability
- **Smart Lid Design** – Designed with no holes to keep out pests, beveled edges to minimize damage potential from turf equipment, and for easy hand and shovel access
- **Flexible Installations** – Interlocking stacking capabilities, extension models and pipe hole knockouts support deeper and flexible installations
- **Environmentally Friendly** – Earth-friendly, LEED-compliant material made of 100% recycled materials (black boxes and black lids only)



7 Inch Round Valve Box	10 Inch Round Valve Box	Standard Valve Box	Standard Extension	Jumbo Valve Box	Jumbo Extension	Super Jumbo Valve Box	Maxi Jumbo Valve Box
<b>SIZE</b>							
Bottom Diameter: 9.9 inches (25,1 cm) Height: 9.0 inches (22,9 cm)	Bottom Diameter: 13.75 inches (34,9 cm) Height: 10.0 inches (25,4 cm)	Length: 21.8 inches (55,4 cm) Width: 16.6 inches (42,2 cm) Height: 12.0 inches (30,5 cm)	Length: 20.0 inches (50,8 cm) Width: 14.75 inches (37,5 cm) Height: 6.75 inches (17,1 cm)	Length: 26.3 inches (66,8 cm) Width: 19.8 inches (50,3 cm) Height: 12.1 inches (30,7 cm)	Length: 24.4 inches (62,0 cm) Width: 17.9 inches (45,5 cm) Height: 6.75 inches (17,1 cm)	Length: 33.1 inches (84,1 cm) Width: 23.8 inches (60,5 cm) Height: 15.0 inches (38,1 cm)	Length: 40.3 inches (102,4 cm) Width: 27.1 inches (68,8 cm) Height: 18.0 inches (45,7 cm)
<b>ADDITIONAL FEATURES</b>							
<ul style="list-style-type: none"> <li>• Easily removable knock-outs simplify pipe placement and reduce installation time</li> <li>• Four equally spaced knock-outs accommodate up to 2.0" diameter pipe</li> </ul>	<ul style="list-style-type: none"> <li>• Easily removable knock-outs simplify pipe placement and reduce installation time</li> <li>• Four equally spaced knock-outs accommodate up to 2.0" diameter pipe</li> </ul>	<ul style="list-style-type: none"> <li>• Two large center knock-outs accommodate up to 3 1/2" (8.9 cm) diameter pipe and eleven knock-outs accommodate up to 2" (5.0 cm) diameter pipe</li> </ul>	<ul style="list-style-type: none"> <li>• Extension models support deeper and more flexible installations</li> </ul>	<ul style="list-style-type: none"> <li>• Easily removable knock-outs simplify pipe placement and reduce installation time</li> <li>• Two large center knock-outs accommodate up to 3.5" diameter pipe. (Extensions do not have knock-outs)</li> </ul>	<ul style="list-style-type: none"> <li>• Extension models support deeper and more flexible installations</li> </ul>	<ul style="list-style-type: none"> <li>• Easily removable knock-outs simplify pipe placement and reduce installation time</li> <li>• Thirteen large knock-outs accommodate up to 3.5" diameter pipe</li> </ul>	<ul style="list-style-type: none"> <li>• Easily removable knock-outs simplify pipe placement and reduce installation time. Six large knock-outs on the ends accommodate up to 5.0" diameter pipe and 12 knock-outs on the sides accommodate up to 3.0" diameter pipe</li> </ul>
<b>MODELS</b>							
<ul style="list-style-type: none"> <li>• VB7RND: 7" Round Body &amp; Green Lid</li> </ul>	<ul style="list-style-type: none"> <li>• VB10RND: 10" Round Body &amp; Green Lid</li> <li>• VB10RNDNB: 10" Round Body Only</li> <li>• VB10RNDGL: Green Lid</li> <li>• VB10RNDPL: Purple Lid</li> <li>• VB10RNDDBKL: Black Lid</li> <li>• VB10RNDH: 10" Round Body &amp; Locking Green Lid</li> </ul>	<ul style="list-style-type: none"> <li>• VBSTD: Standard Body &amp; Green Lid</li> <li>• VBSTDDB: Standard Body Only</li> <li>• VBSTDGL: Green Lid</li> <li>• VBSTDPL: Purple Lid</li> <li>• VBSTDDBKL: Black Lid</li> <li>• VBSTDH: Standard Body &amp; Locking Green Lid</li> </ul>	<ul style="list-style-type: none"> <li>• VBSTD6EXTB: Standard Extension Body Only</li> </ul>	<ul style="list-style-type: none"> <li>• VBJMB: Jumbo Body &amp; Green Lid</li> <li>• VBJMBB: Jumbo Body Only</li> <li>• VBJMBGL: Green Lid</li> <li>• VBJMBPL: Purple Lid</li> <li>• VBJMBBKL: Black Lid</li> <li>• VBJMBH: Jumbo Body &amp; Locking Green Lid</li> </ul>	<ul style="list-style-type: none"> <li>• VBJMB6EXTB: Jumbo Extension Body Only</li> </ul>	<ul style="list-style-type: none"> <li>• VBSPRH: Super Jumbo Body &amp; 2 Lock Green Lid</li> <li>• VBSPRPH: Super Jumbo Body &amp; 2 Lock Purple Lid</li> </ul>	<ul style="list-style-type: none"> <li>• VBMAXH: Maxi-Jumbo Body &amp; 2 Lock Green Lid</li> <li>• VBMAXPH: Maxi-Jumbo Body &amp; 2 Lock Purple Lid</li> </ul>

#### LOCKING SYSTEMS

- VB-LOCK-H: Hex head 3/8" x 2 1/4" (1.0 x 5.7 cm) bolt, washer, and clip
- VB-LOCK-P: Penta head 3/8" x 2 1/4" (1.0 x 5.7 cm) bolt, washer, and clip

VANDAL RESISTANT

## 24 VAC Solenoid Valves Wire Sizing – 50Hz

9.8 VA Valves (EZ) with 26.5 Volt Transformers - Equivalent Feet of Circuit								
80 psi (5.5 bar) Water Pressure at Valve								
Common Wire Size	Control Wire Size							
	18 ●	16 ●	14 ●	12 ●	10 ●	8 ●	6 ●	4 ●
18	3700							
16	4600	6000						
14	5400	7400	9600					
12	6000	8600	11800	15200				
10	6500	9600	13700	18700	24200			
8	6900	10400	15400	21800	29700	38500		
6	7100	10900	16600	24300	34600	47100	60600	
4	7300	11300	17500	26300	38800	55100	74600	97000
100 psi (6.9 bar) Water Pressure at Valve								
Common Wire Size	Control Wire Size							
	18 ●	16 ●	14 ●	12 ●	10 ●	8 ●	6 ●	4 ●
18	3200							
16	4000	5200						
14	4700	6400	8300					
12	5200	7400	10200	13200				
10	5600	8300	11900	16200	20900			
8	5900	9000	13300	18900	25700	33300		
6	6100	9500	14300	21100	29900	40700	52400	
4	6300	9800	15100	22800	33500	47700	64600	83900
125 psi (8.6 bar) Water Pressure at Valve								
Common Wire Size	Control Wire Size							
	18 ●	16 ●	14 ●	12 ●	10 ●	8 ●	6 ●	4 ●
18	2900							
16	3500	4600						
14	4100	5700	7400					
12	4600	6600	9000	11700				
10	5000	7400	10500	14400	18600			
8	5300	8000	11800	16800	22800	29600		
6	5400	8400	12700	18700	26600	36200	46600	
4	5600	8700	13400	20200	29800	42300	57300	74600
150 psi (10.4 bar) Water Pressure at Valve								
Common Wire Size	Control Wire Size							
	18 ●	16 ●	14 ●	12 ●	10 ●	8 ●	6 ●	4 ●
18	2600							
16	3200	4100						
14	3700	5000	6600					
12	4100	5900	8100	10400				
10	4500	6600	9400	12800	16600			
8	4700	7100	10500	15000	20400	26400		
6	4900	7500	11400	16700	23800	32300	41600	
4	5000	7800	12000	18100	26600	37800	51300	66600
200 psi (13.8 bar) Water Pressure at Valve								
Common Wire Size	Control Wire Size							
	18 ●	16 ●	14 ●	12 ●	10 ●	8 ●	6 ●	4 ●
18	2400							
16	2900	3800						
14	3400	4700	6100					
12	3800	5500	7500	9700				
10	4100	6100	8800	11900	15500			
8	4400	6600	9800	13900	19000	24600		
6	4500	7000	10600	15500	22100	30100	38700	
4	4600	7200	11100	16800	24800	35200	47700	62000

## Commercial Valve Wire Sizing Procedure

### Step 1

Determine actual distance, along wire run, from controller out to the first valve on a circuit and between each succeeding valve on a multiple valve circuit. Example: (Two watt solenoid, 26.5 volt transformer, 50Hz, at 150 psi water pressure at valves.)

### Step 2

Calculate the equivalent circuit length for each valve circuit on the controller. (See chart to left)

### Step 3

Selecting Common Wire Size: Using the longest equivalent length calculated above, go to the appropriate valve chart and select a common wire and a control wire that are as close to the same size as possible (the common wire size should always be equal to or one size larger than the control wire size.) In the example above, the circuit for station #3 has the longest equivalent length, 7000 feet. In the chart (for this example use the chart for 150 psi water pressure at the valve and a 26.5 volt transformer) select a wire size combination of size 14 and 12 wire. Select common wire as size 12 wire. Since one common wire shall be used for all valves on the controller, you have now established the common wire size for that controller as size 12 wire.

### Step 4

Sizing Circuit Control Wires: Reading only from the row for the common wire size selected in Step 3 (size 12), proceed to select each control wire size from the chart using the calculated equivalent length for each circuit.

**Station #1:** Equiv. Length = 1 valve x 2000 ft. = 2000 ft. select size 18 control wire

**Station #2:** Equiv. Length = (1 valve x 1000 ft.) + (2 valves x 2000 ft.) = 5000 ft. select size 16 control wire

**Station #3:** Equiv. Length = (1 valve x 500 ft.) + (2 valves x 1000 ft.) + (3 valves x 1500 ft.) = 7000 ft. select size 14 control wire

## 24 VAC Solenoid Valves Wire Sizing – 60Hz

9.8 VA Valves (EZ) with 26.5 Volt Transformers - Equivalent Feet of Circuit								
80 psi (5.5 bar) Water Pressure at Valve								
Common Wire Size	Control Wire Size		14 ●	12 ●	10 ●	8 ●	6 ●	4 ●
	18 ●	16 ●						
18	3200							
16	4000	5200						
14	4700	6400	8300					
12	5200	7500	10200	13200				
10	5700	8300	11900	16200	21000			
8	6000	9000	13300	18900	25800	33400		
6	6200	9500	14400	21100	30100	40900	52600	
4	6300	9800	15200	22900	33700	47800	64800	84200
100 psi (6.9 bar) Water Pressure at Valve								
Common Wire Size	Control Wire Size		14 ●	12 ●	10 ●	8 ●	6 ●	4 ●
	18 ●	16 ●						
18	2900							
16	3500	4600						
14	4100	5600	7300					
12	4600	6600	9000	11700				
10	5000	7400	10500	14300	18600			
8	5300	8000	11800	16700	22800	29500		
6	5400	8400	12700	18700	26500	36100	46500	
4	5600	8700	13400	20200	29700	42200	57200	74400
125 psi (8.6 bar) Water Pressure at Valve								
Common Wire Size	Control Wire Size		14 ●	12 ●	10 ●	8 ●	6 ●	4 ●
	18 ●	16 ●						
18	2400							
16	3000	3900						
14	3500	4800	6300					
12	3900	5600	7700	9900				
10	4300	6300	9000	12200	15800			
8	4500	6800	10000	14300	19400	25200		
6	4600	7100	10800	15900	22700	30800	39700	
4	4700	7400	11400	17200	25400	36100	48800	63500
150 psi (10.4 bar) Water Pressure at Valve								
Common Wire Size	Control Wire Size		14 ●	12 ●	10 ●	8 ●	6 ●	4 ●
	18 ●	16 ●						
18	2200							
16	2700	3500						
14	3100	4300	5600					
12	3500	5000	6800	8800				
10	3800	5600	8000	10900	14100			
8	4000	6000	8900	12700	17300	22400		
6	4100	6300	9600	14100	20100	27400	35300	
4	4200	6600	10200	15300	22600	32100	43400	56500
200 psi (13.8 bar) Water Pressure at Valve								
Common Wire Size	Control Wire Size		14 ●	12 ●	10 ●	8 ●	6 ●	4 ●
	18 ●	16 ●						
18	1800							
16	2300	2900						
14	2600	3600	4700					
12	3000	4200	5800	7500				
10	3200	4700	6800	9200	12000			
8	3400	5100	7600	10800	14700	19000		
6	3500	5400	8200	12000	17100	23300	30000	
4	3600	5600	8600	13000	19200	27300	36900	48000

## Commercial Valve Wire Sizing Procedure

### Step 1

Determine actual distance, along wire run, from controller out to the first valve on a circuit and between each succeeding valve on a multiple valve circuit. Example: (Two watt solenoid, 26.5 volt transformer, 60Hz, at 150 psi water pressure at valves.)

### Step 2

Calculate the equivalent circuit length for each valve circuit on the controller. (See chart to left)

### Step 3

Selecting Common Wire Size: Using the longest equivalent length calculated above, go to the appropriate valve chart and select a common wire and a control wire that are as close to the same size as possible (the common wire size should always be equal to or one size larger than the control wire size.) In the example below, the circuit for station #3 has the longest equivalent length, 7000 feet. In the chart (for this example use the chart for 150 psi water pressure at the valve and a 26.5 volt transformer) select a size 12 wire for both common and control wire. Since one common wire shall be used for all valves on the controller, you have now established the common wire size for that controller as size 12 wire.

### Step 4

Sizing Circuit Control Wires: Reading only from the row for the common wire size selected in Step 3 (size 12), proceed to select each control wire size from the chart using the calculated equivalent length for each circuit.

### EXAMPLE:

**Station #1:** Equiv. Length = 1 valve x 2000 ft. = 2000 ft. select size 18 control wire

**Station #2:** Equiv. Length = (1 valve x 1000 ft.) + (2 valves x 2000 ft.) = 5000 ft. select size 16 control wire

**Station #3:** Equiv. Length = (1 valve x 500 ft.) + (2 valves x 1000 ft.) + (3 valves x 1500 ft.) = 7000 ft. select size 12 control wire





*The ESP-LX Basic Controller offers simple irrigation programming options you need for commercial sites. The simple dial makes programming the controller straightforward, and easy-to-understand menu options guide you through set-up. The ESP-LX Basic is the first controller to offer both English and Spanish on one dial.*

*With 48-station capacity, four independent programs, and up to eight start times for each program, the ESP-LX Basic offers flexible scheduling options.*



## Water Saving Tips

- A Seasonal Adjust feature is available on all Rain Bird AC-powered controllers, allowing users to easily adjust irrigation schedules to changing seasonal landscape water requirements. The ESP-LX Series Controllers also feature an automated Monthly Seasonal Adjust feature to help save water through automatic adjustments every month of the year.
- Water savings can also be optimized through daily irrigation schedule adjustments which fine-tune watering based on current weather. All ESP-LX series controllers can easily be upgraded to include smart weather-based/ET or soil moisture irrigation control capability by adding the Rain Bird ET Manager Cartridge or a local rain sensor or soil moisture sensor.
- All Rain Bird controllers simplify conservation through a variety of flexible programming features. With the touch of a button, the ESP-Me can recall a previously saved "Contractor Default" irrigation program; the ESP-LX Series "Delayed Recall" feature automatically reverts to typical watering programs after a user-set time period.

Major Products							
Primary Applications	WiFi Ready 		WiFi Ready 				
	ESP-TM2	ESP-Me	ESP-SMTe	ESP-LX BASIC	ESP-LXME ESP-LXMEF	ESP-LXD	TBOS II™
Residential	•	•	•				•
Light Commercial	•	•	•	•	•	•	•
Commercial/Industrial				•	•	•	•
<b>Type of Controller</b>							
Hybrid	•	•	•	•	•	•	
Solid State							•
Battery Operated							•
Indoor Location	•	•	•	•	•	•	
Outdoor Location	•	•	•	•	•	•	
<b>Features</b>							
Stations (up to)	12	22	22	48	48	200	6
Programs (up to)	3	4	22	4	4	4	3
Station Timing (up to)	6 hr <sup>1</sup>	6 hr <sup>1</sup>	weather-based	12 hr <sup>1</sup>	12 hr <sup>1</sup>	12 hr <sup>1</sup>	12 hr
Number of Starts per Program (up to)	4	6	N/A	8	8	8	8
Surge protection	•	•	•	•	•	•	
230VAC Option		•		•	•	•	
Master Valve/Pump Start	•	•	•	• <sup>2</sup>	• <sup>2</sup>	• <sup>2</sup>	
Water Budgeting	•	•	•	• <sup>4</sup>	• <sup>4</sup>	• <sup>4</sup>	
Individual Program/Zone Shut-Off	•	•	•	•	•	•	
Rain Delay	•	•	•	•	•	•	
Battery Programmable	•	•	•	•	•	•	•
Sensor Terminals, Status Indicator and Override	•	•	•	•	•	•	
Delay Between Stations (up to)	9 hrs	9 hrs	9 hrs	0 - 10 min.	0 - 10 min.	0 - 10 min.	
Flow Sensing					• <sup>5</sup>	•	
Simultaneous Multi-Station Operation				•	•	•	•
Cycle + Soak™			•	•	•	•	
<b>Overlapping Programs</b>							
Manual On/Off	•	•	•	•	•	•	•
Remote Control Compatible	•	•	•	•	•	•	
Diagnostic Test			•	•	•	•	
Diagnostic Valve Circuit Breaker	•	•	•	•	•	•	
Out-of-Valve Box Programming							•
Submersible (up to)							3.3 ft (1 m)
Vandal/Tamper Resistant							•
Self-Cleaning Solenoid							•
Low Battery Indicator							•
Save / Restore Programs	•	•	•	•	•	•	•
Master Valve ON/OFF by Station	•	•	•	•	•	•	•
Total Run Time Calculator by Program	•	•	•	•	•	•	•
Bypass Rain Sensor by Station	•	•	•	•	•	•	
<b>Programming Schedule</b>							
7 Day-of-Week	•	•	•	•	•	•	•
1-7 Variable Cycle	•	•	•	•	•	•	•
1-31 Variable Cycle	•	•	•	•	•	•	•
Odd/Even Cycle	•	•	•	•	•	•	•
Odd 31st	•	•	•	•	•	•	•
365-Day Calendar	•	•	•	•	•	•	•
Event Day Off			•	•	•	•	
<b>Central Control Compatibility</b>							
IQ™ Upgradeable					•	•	
<b>Cabinet</b>							
Plastic-Indoor	•	•	•				
Plastic-Outdoor	•	•	•	•	•	•	•
Powder-Coated Metal Outdoor				•	•	•	
Stainless Steel Pedestal				•	•	•	
Powder-Coated Metal Pedestal				•	•	•	
<b>Hardware/Accessories</b>							
Two-Wire Decoders and Accessories						•	
Rain Sensing (need Rain Sensor)	•	•		•	•	•	•
Flow Sensing (need Flow Sensor)					ESP-LXMEF only	•	
SMRT-Y Soil Moisture Sensor	•	•	•	•			

<sup>1</sup> With water budgeting, timing can be extended    <sup>2</sup> Programmable by station    <sup>3</sup> 6 independent start times per zone    <sup>4</sup> Selectable for each program and by month    <sup>5</sup> With Flow Smart Module



## LNK WiFi Module



Irrigation System Control from Anywhere

### Features

- Upgrades WiFi-ready controllers (ESP-Me and ESP-TM2) to make them fully accessible and programmable from iOS or Android compatible devices\*
- Operates like a wireless remote control for your irrigation system while onsite or an internet-based monitoring and control system when offsite
- Streamlines and simplifies initial irrigation timer setup and seasonal adjustment
- Instant access allows for real-time system management and timer settings
- Compatible professional app features allow for simple multi-site management and as well as remote diagnostics by landscape professionals
- Built-in mobile notifications provide troubleshooting access, simplify service calls, and warn of freezing conditions when expected
- Automatic weather adjustments provide daily run time changes, saving up to 50% in water
- Superior programming capabilities that are designed to meet the most stringent water restrictions

### Specifications

- 2.4 GHz (only) WiFi router compatible with WEP and WPA security settings
- Compatible with iOS 8.0 and Android 4.4 (KitKat) or later mobile devices\*
- Operating Temperature: 14° F (-10° C) to 149°F (65°C)
- Storage Temperature: -40°F (-40°C) to 150°F (66°C)
- Operating Humidity: 95% max @ 50°F to 120°F (10°C to 49°C) non-condensing environment

### Electrical Specifications

- Input: 24VAC(RMS) 50/60Hz; 55mA max

### Certifications

- UL, cUL, CE, CSA, FCC Part 15b, WEEE, S-Mark, IP30, IFETEL

### Dimensions

- Width: 1.13" (2,87 cm)
- Height: 1.83" (4,65 cm)
- Depth: 0.48" (1,22 cm)

### Models

- LNKWIFI



LNK WiFi Module



Upgrades Rain Bird ESP-Me and ESP-TM2 Controllers

### ESP-TM2 Series Controller



Simple, Flexible, and Reliable for Residential Applications

#### Features

- Upgradeable for WiFi-based remote monitoring and control via iOS and Android mobile devices (with LNK WiFi Module sold separately).
- Internet-based weather information can be used to make daily adjustments to the irrigation schedule, saving up to 30% in water (with LNK WiFi Module sold separately).
- 4, 6, 8, and 12 station models to meet small or large residential irrigation needs
- Set Permanent Days Off per program to ensure watering never occurs on days when maintenance crews are on site (for Odd/Even/ Cyclic schedules)
- Easy to install indoors or outdoors with pre-installed 6' power cord
- Quick programming in just 3 steps for ease of setup
- 3 available programs with up to 4 start times for each program to meet the needs of varied landscapes
- One-touch manual watering capability for ease of use
- Large back-lit LCD display for improved visibility in low-light and direct sun conditions
- Contractor Default™ allows you to easily save and restore your custom schedule
- Delay Watering up to 14 days and automatically resume watering after the set delay has elapsed
- Bypass Rain Sensor for any station gives you the ability to customize which stations react to a rain sensor
- Seasonal Adjust by program allows you to easily reduce or increase watering by program

#### Specifications

- Operating Temperature: Up to 149°F (65°C)
- Storage Temperature: -40°F (-40°C) to 150°F (66°C)
- Operating Humidity: 95% max @ 50°F to 120°F (10°C to 49°C) non-condensing environment

#### Electrical Specifications

- Input required: 120VAC (±10%) @ 60Hz
- Output: 1A at 24VAC
- Master Valve/Pump Start Relay
- External battery back-up not required. Nonvolatile memory permanently saves the current programming and a 10 year life lithium battery maintains the controllers time and date during power outages

#### Certifications

- UL, cUL, FCC Part 15b, IP24

#### Dimensions

- Width: 7.92 in. (20,1 cm)
- Height: 7.86 in. (20,0 cm)
- Depth: 3.51 in. (9,0 cm)

#### Models

- TM2-4-120V: 4-station 120VAC
- TM2-6-120V: 6-station 120VAC
- TM2-8-120V: 8-station 120VAC
- TM2-12-120V: 12-station 120VAC

#### Optional Accessories

- LNKWiFi: LNK WiFi Module for remote control and notification via iOS or Android device
- WR2 Series Wireless Rain / Freeze Sensors
- RSD Series Rain Sensors



ESP-TM2

## ESP-Me Series Controllers

The industry's most flexible irrigation controller solution.  
Supports up to 22 stations



### Features

- Large LCD display with easy to navigate user interface
- Rain Sensor input with override capability
- Master valve/pump start circuit
- Non-Volatile (100 year) storage memory
- Remotely Programmable under 9V battery power (not included)
- Program based scheduling allows 4 individual programs with 6 independent start times per program for 24 total start times
- Watering schedule options: By days of week, ODD calendar days, EVEN calendar days, or Cyclic (every 1 – 30 days) Advanced Features
- Advanced diagnostics and short detection with LED alert
- Contractor Default™ Program Save/Restore saved program(s)
- Rain Sensor bypass by Station
- Total Run Time Calculator by program
- One Touch manual watering
- Delay Watering up to 14 days (applies only to stations not set to ignore Rain Sensor)
- Manual Watering option by program or station
- Seasonal Adjust applied to all programs or individual program
- Adjustable delay between valves (default set to 0)
- Master Valve on/off by station
- Upgradeable for WiFi-based remote monitoring and control via iOS and Android mobile devices (with LNK WiFi Module sold separately).
- Internet-based weather information can be used to make daily adjustments to the irrigation schedule, saving up to 30% in water (with LNK WiFi Module sold separately).

### Operating Specifications

- Station timing: 1 minute to 6 hours
- Seasonal Adjust: 5% to 200%
- Max operating temperature: 149°F (65°C)

### Electrical Specifications

- Input Required: 120VAC ± 10%, 60Hz  
(International models: 230/240VAC ± 10%, 50/60Hz)
- Master Valve/Pump Start Relay
- Operating Voltage: 24VAC 50/60Hz
- Max Coil Inrush: 11VA
- Max Coil Holding: 5VA
  - Idle/Off power draw 0.06 amps at 120VAC
- Power back-up not required. Nonvolatile memory permanently saves the current programming and a 10 year life lithium battery maintains the controllers time and date during power outages.

### Certifications

- UL, cUL, CE, CSA, C-Tick, FCC Part 15b, WEEE, S-Mark, IP24

### Dimensions

- Width: 10.7" (27.2 cm)
- Height: 7.7" (19.5 cm)
- Depth: 4.4" (11.2 cm)

### North America Models (120VAC)

- Controller Base Models
  - ESP4MEI: 4 station indoor model
  - ESP4ME: 4 station outdoor model\*
- Modules
  - ESPSM3: 3 station module
  - ESPSM6: 6 station module (compatible with ESP-Me Series controllers only)

### Accessories

- LNKWiFi: LNK WiFi Module for remote control and notification via iOS or Android device
- RSD-BEx / RSD-CEX: Wired Rain Sensor
- WR2: Wireless Rain + Freeze Sensors
- PIGTAIL: UL approved pig tail

*\*Also available in 230VAC and 240VAC models*



ESP-Me Series Controller and Modules

### ESP-SMTe Smart Modular Control System

4 to 22 Station Indoor or Outdoor Smart Modular Control System for Residential and Light Commercial Use



#### Features

- English/Spanish Button easily switches the display text between languages
- Weather Sensor sends rainfall and temperature data to the controller
- Large LCD display with easy to use interface
- Non-Volatile (100- year) program memory
- Remotely Programmable under 9V battery power (not included)
- Programming tutorial assures efficient and accurate scheduling
- Watering occurs only as needed and can be restricted to selected days of the week, odd or even calendar days or at set intervals (cyclic)
- Grow-in watering option allows a time based schedule for new plants for a programmed period of time
- Cycle+Soak™ feature for each zone prevents runoff based on soil type, precipitation rate and landscape slope
- Any zone can be switched to Time Based programming (for example, to operate a pond pump)
- Copy Zone to Zone feature allows the contractor to copy a zone program from one zone to another
- Event Days Off allows you to select up to four specific dates to block watering
- Rainfall Shutdown suspends all irrigation if the measured rainfall exceeds a user set threshold
- Cold Weather Shutdown suspends all irrigation to prevent potential freeze damage
- Contractor Default™ allows the controller zone settings to be saved/restored
- Next Irrigation Estimate shows an estimated schedule up to three weeks in advance
- Weather Log holds historical weather data for 30 days
- Event Log by date or by zone
- Manual Watering allows immediate watering of a selected zone or all zones
- Enable or disable Master Valve by zone
- Advanced diagnostics and short circuit detection

#### Operating Specifications

- 2 Watering Windows per zone
- Fine Tune watering adjustment -60% to +60% by zone
- Programmable delay between zones (default set to 3 seconds)

#### Electrical Specification

- Input Required: 120VAC +/- 10%, 60 Hz
- Output: 25.5VAC 1A
- IP 24

- Valve/solenoid capacity (two 24VAC, 7VA solenoids plus a master valve)
- Nonvolatile memory saves programming
- 10 year life lithium battery maintains the controller's time and date
- Master Valve/Pump Start Relay:
  - Operating Voltage: 24VAC 50/60Hz
  - Max Coil Inrush: 11VA
  - Max Coil Holding: 5VA
- Idle/Off power draw 0.06 amps at 120VAC
- Certifications
  - WaterSense approved, meets EPA criteria for high-performing, water efficient products.
  - UL, cUL, FCC Part 15b

#### Dimensions

- Width: 10.7 in. (27.2 cm)
- Height: 7.7 in. (19.5 cm)
- Depth: 4.4 in. (11.2 cm)
- Mounting Bracket
  - Maximum reach: 7.0" (17.8 cm)

#### Models

- Control System Base Models (includes ESP-SMTe controller & weather sensor)
  - ESP4SMTEI – 4 station indoor\* - 120V
  - ESP4SMTE – 4 station outdoor\* -120V
- Upgrade Model (includes ESP-SMTe controller panel & weather sensor)
  - ESPSMTEUPG – Kit to Upgrade existing ESP-Modular or ESP-Me Controllers\*\*
- Modules
  - ESPSM3 – 3-station expansion module
  - ESPSM6 – 6 station expansion module

\* To expand up to 22 stations, use ESPSM3 or ESPSM6 modules – Station Expansion Modules  
\*\* Applies to ESP-M controllers manufactured after April, 2005

**Note:** All ESP-SMTe models come with a heavy-duty adjustable bracket and 25 feet of 18-2 UV-rated non-burial wire for connection between the controller panel and the weather sensor pod. Up to 200 feet of appropriate wire may be spliced to extend range.



ESP-SMTe Smart Modular Control System

## ESP-LX Basic Controller



The easiest to use commercial controller

### Features

- Two Languages, One Dial: English and Spanish are both on one simple dial making it easy to install and maintain
- Larger Station Count compared to competitive commercial controllers. The ESP-LX Basic base model has 12 stations and has capacity for 48 stations using 12-station modules
- Flexible features and modular options make the controller ideal for a wide variety of applications including large residential, light commercial, and large commercial irrigation systems
- ESP = Extra-Simple Programming user interface and large LCD display with softkey text labels
- Simple, Three-Step Programming can be done using minimal dial positions. Additional programming options can be accessed through the Basic Setup and Station Timing dial positions
- Water Management Features: SimulStations™ (Operate two stations simultaneously), Cycle+Soak™, Station Delay, Seasonal Adjust, Sensor & Master Valve Programmable by Station
- Contractor Default™ allows the user to create a customized default program that can be automatically recalled up to 90 days in the future. This allows a temporary schedule to be created for new seed or a fast fix
- Enhanced Diagnostic Feedback™ with RASTER™ Wiring Test with external alarm light and on-screen messaging alert the user of conditions that may disrupt controller operation
- ESP-LX Basic is not compatible with IQ NCC Cartridges

### Electrical Specifications

- Power Supply Voltage: 120 VAC  $\pm$  10%, 60Hz
- Output: 26.5 VAC 1.9A
- Power back-up: Lithium coin-cell battery maintains time and date while nonvolatile memory maintains the programming
- Multi-valve capacity: Maximum two 24 VAC, 7VA solenoid valve simultaneous operation including master valve

### Certifications

- UL, cUL, CE, CSA, C-Tick, FCC Part 15

### Controller Hardware

- Plastic, locking, UV resistant, wall-mount case
- Optional Metal/Stainless Steel Case & Pedestal
- 12-station base unit expandable to 48 stations with 12-Station Modules

### Dimensions

- Width: 14.32 in. (36.4 cm)
- Height: 12.69 in. (32.2 cm)
- Depth: 5.50 in. (14.0 cm)

### Models

- ESPLXBASIC: ESP-LX Basic 12 Station Controller, 120VAC
- ESPLXBFP: ESP-LX Basic Controller Front Panel
- LXBASEMOD: ESP-LX Series Base Module for LX Basic and non flow LXME
- ESPLXMSM8: 8-Station Module for ESP-LXME/F and ESP-LX Basic Controller
- ESPLXMSM12: 12-Station Module for ESP-LXME/F and ESP-LX Basic Controller

### Optional Accessories

- Painted Metal and Stainless Steel Pedestal/Enclosure Options available (see page 94)

**For more information call the ESP-LX Hotline: 1-866-544-1406**

**Note:** The ESP-LX Basic is not compatible with IQ NCC Communication Cartridges



ESP-LX Basic Controller

### ESP-LXME/F Controllers

Modular - Easily expandable from 8 or 12 stations up to 48 stations with 8- and 12-station modules

#### Features

- Hot-swappable modules, no need to power down the controller to add/remove modules
- 8- or 12-stations base unit expandable to 48 stations with 8- and 12-Station Modules
- Flow Smart Module™ factory installed (ESP-LXMEF) or field upgradable (ESP-LXME)
- Dynamic station numbering eliminates station numbering gaps
- Master valve/pump start circuit
- Weather Sensor input with override switch
- 6 user-selectable languages
- Standard 10kV surge protection
- Non-Volatile (100-year) program memory
- Front panel is removable and programmable under battery power
- Compatible with Rain Bird Landscape Irrigation and Maintenance Remote
- Plastic, locking, UV resistant, wall-mount case, Optional Metal and Stainless Steel Case & Pedestal

#### Water Management Features

- Optional Flow Smart Module™ with Learn Flow utility and flow usage totalizer — standard on ESP-LXMEF
- FloWatch™ protection for high and low flow conditions with user defined reactions (requires flow sensor)
- FloManager™ manages hydraulic demand, making full use of available water to shorten total watering time
- SimulStations™ are programmable to allow up to 5 stations to operate at the same time
- Station sequencing by station numbers or station priorities
- Water Windows by program plus Manual MV Water Window
- Cycle+Soak™ by station
- Rain Delay
- 365-Day Calendar Day Off
- Programmable Station Delay by program
- Normally Open or Closed Master Valve programmable by station
- Weather Sensor programmable by station to prevent or pause watering
- Program Seasonal Adjust
- Global Monthly Seasonal Adjust

#### Operating Specifications

- Station run times: 0 min to 12 hrs
- Seasonal Adjust; 0% to 300% (16 hrs maximum station run time)
- 4 independent programs (ABCD)
- ABCD programs can overlap

- 8 start times per program
- Program Day Cycles include Custom days of the week, Odd, Odd31, Even, & Cyclical dates
- Manual station, program, test program

#### Electrical Specifications

- Power Supply Voltage: 120 VAC ± 10%, 60Hz (International models: 230 VAC ± 10%, 50Hz; Australian models: 240 VAC ± 10%, 50Hz)
- Output: 26.5 VAC 1.9A
- Power back-up: Lithium coin-cell battery maintains time and date while nonvolatile memory maintains the programming
- Multi-valve capacity: Maximum five 24 VAC, 7VA solenoid valves simultaneous operation including the master valve, maximum two solenoid valves per station module
- Certifications: UL, cUL, CE, CSA, C-Tick, FCC Part 15

#### Dimensions

- Width: 14.32 in. (36.4 cm)
- Height: 12.69 in. (32.2 cm)
- Depth: 5.50 in. (14.0 cm)

#### Models

- ESP8LXME: 8-Station Controller, 120VAC
- ESP12LXMEF: 12-Station Controller with Flow Smart Module, 120VAC
- IESP8LXME: 8-Station Controller for International Market, 230VAC
- FSMLXME: Flow Smart Module for ESPLXME/F Controller
- ESPLXMSM8: 8-Station Module for ESP-LXME/F Controller
- ESPLXMSM12: 12-Station Module for ESP-LXME/F Controller
- ESPLXMEFP: ESPLXME Controller Front Panel Only

#### Accessories

- Painted Metal and Stainless Steel Pedestal/Enclosure Options available (see page 94)
- IQ Communication Cartridge (see page 102)
- Rain Bird FS-Series Flow Sensors (see page 95)

For more information call the ESP-LX Hotline: 1-866-544-1406



ESP-LXME Controller

## ESP-LXD Decoder Controller

50 – 200 station capable Two-Wire Decoder  
Commercial Controller

### Controller Features

- 50-station capability standard expandable to 200 stations with optional ESPLXD-SM75 modules
- Four available sensor inputs (one wired plus up to three decoder-managed) with override switch
- Five flow sensors supported
- Supported decoders: FD-101TURF, FD-102TURF, FD-202TURF, FD-401TURF, FD-601TURF
- Supports SD-210TURF sensor decoders (flow sensing and weather sensor support) and LSP-1 line surge protectors (one per 500 feet of two-wire path required)
- Central Control capable with Rain Bird IQ Communications Cartridges and software (see pg. 102)
- Advanced Features From Cycle+Soak™ to Contractor Default Program™, the ESP-LXD offers innovative features proven to cut installation expenses, troubleshooting time and water use
- Program backup and barcode decoder address entry with the optional PBCLXD
- Six user-selectable languages
- Removable front panel is programmable under battery power
- Plastic, locking, UV resistant, wall-mount case, Optional Metal and Stainless Steel Case & Pedestal
- Compatible with Rain Bird Landscape Irrigation and Maintenance Remote - Flow Smart Module™ factory installed or field upgradable
- Plastic, locking, UV resistant, wall-mount case, Optional Metal and Stainless Steel Case & Pedestal

### Operating Specifications

- Station timing: 0 min to 12 hrs
- Program level and global Monthly Seasonal Adjust; 0% to 300% (16 hrs maximum station run time)
- 4 independent programs (ABCD); ABC programs stack, ABCD overlap
- 8 start times per program
- Program Day Cycles include Custom days of the week, Odd, Odd no 31st, Even, and Cyclical dates
- Manual station, program, test program
- Certifications: UL, CE, cUL, C-Tick

### Upgrade Options

- IQ-NCC Network Communication Cartridge
- ESP-LXD-SM75 75-station module
- PBCLXD Programming Backup Cartridge



ESP-LXD Decoder  
Controller



LXMMSSPED Shown  
with ESP-LXD in LXMMSS  
Stainless Steel Cabinet

## ESP-LXD Decoder Controller (cont.)

### Electrical Specifications

- Power Supply Voltage: 120 VAC ± 10%, 60Hz (International models: 230 VAC ± 10%, 50Hz; Australian Models: 240 VAC ± 10%, 50Hz)
- Power back-up: Lithium coin-cell battery maintains time and date while nonvolatile memory maintains the schedule
- Multi-valve station capacity: up to 2 solenoid valves per station; simultaneous operation of up to eight solenoids and/or master valves

### Dimensions (W x H x D)

- 14.32" x 12.69" x 5.50" (36.4 x 32.2 x 14.0 cm)

### Model

- ESP-LXD: 50-station, 120 VAC
- IESPLXD: 50-station for international markets, 230 VAC
- IESPLXDEU: 50-station for Europe, 230 VAC
- IESPLXDAU: 50-station for Australia, 240 VAC

### Accessories

- FD-TURF: two-wire decoders (see pg. 89)
- SD-210TURF: two-wire sensor decoder (see pg. 89)
- LSP1TURF: two-wire line surge protection (see pg. 89)
- DPU-210: two-wire decoder programming unit (see pg. 87)
- Painted Metal and Stainless Steel Pedestal/Enclosure Options available (see pg. 94)
- IQ-NCC: Network Communication Cartridge for ESP-LX Series Controllers (see page 102)
- See page 95 for information on Rain Bird FS-Series Flow Sensors

<sup>1</sup>FD-TURF decoders include peel-off barcode address labels

<sup>2</sup>Barcode scanning pen not included – sold separately; Unitech MS100NRCB00-SG recommended ([www.ute.com](http://www.ute.com))

For more information call the ESP-LX Hotline: 1-866-544-1406

## PBCLXD Programming Backup Cartridge for ESP-LXD

Provides program backup and restore and barcode scanning capability for the ESP-LXD controller (not compatible with ESP-LXME or ESP-LX Basic)

### Upgrade Kit Features

- Provides 8 full backups, including all programs, flow information and decoder addresses – allows you to easily archive 8 different controllers – restoring all information typically takes two minutes or less
- Snaps into the back of the ESP-LXD front panel; installs without tools; no additional enclosures or external wiring required
- Kit includes cable for interface to barcode scanning pen (pen not included) – allows you to quickly scan decoder addresses into the ESP-LXD controller during installation to save you time

### Model

- PBCLXD (works with all versions of the ESP-LXD controller)



PBCLXD Cartridge

## Pigtail

### Features

- 6-feet (1.8 m) long
- Three 16 gauge stranded conductor wires
- 90 degree molded plug type NEMA 5-15P
- Gray color

### Model

- PIGTAIL



PIGTAIL



## Controller Pedestals

Pedestals for ESP-LX Series, ESP-MC, ESP-SAT, ESP-SITE, and CCU

### Features

- Includes all necessary mounting bolts, nuts, and washers

### Specifications

- Material: Powder-coated steel and stainless steel
- Field wiring connection: In controller

### Dimensions

Model	Height	Width	Depth
• LXMM	12 <sup>7</sup> / <sub>8</sub> " (32.7 cm)	14 <sup>1</sup> / <sub>2</sub> " (36.8 cm)	7 <sup>3</sup> / <sub>4</sub> " (19.7 cm)
• LXMPED	28" (71.1 cm)	14 <sup>1</sup> / <sub>4</sub> " (36.2 cm)	7 <sup>1</sup> / <sub>4</sub> " (18.4 cm)
• LXMMSS	12 <sup>7</sup> / <sub>8</sub> " (32.7 cm)	14 <sup>1</sup> / <sub>2</sub> " (36.8 cm)	7 <sup>3</sup> / <sub>4</sub> " (19.7 cm)
• LXMMSSPED	28" (71.1 cm)	14 <sup>1</sup> / <sub>4</sub> " (36.2 cm)	7 <sup>1</sup> / <sub>4</sub> " (18.4 cm)

### Model

- LXMM: Metal Cabinet for ESP-LX Series Controllers\*
- LXMPED: Metal Pedestal for ESP-LX Series Controllers\*
- LXMMSS: Stainless Steel Metal Wall Mount Enclosure for ESP-LX Series Controllers
- LXMMSSPED: Stainless Steel Metal Pedestal for ESP-LX Series Controllers

\* **Note:** Metal cabinets and pedestals are not standard on ESP-LX Series controllers and must be purchased separately. LXMPED requires LXMM, and LXMMSSPED requires LXMMSS.



LXMMSSPED Shown with ESP-LXD in LXMMSS Stainless Steel Cabinet

## FD-TURF Two-Wire Decoders

SiteControl and ESP-LXD with Support for 1, 2, 4 or 6 Decoder Addresses

### Features

- Five different decoder options let you choose the precise amount of landscape irrigation control you need. Select different two-wire decoders to operate one, two, four, or six valves.
- Installed out of sight and protected from the elements and vandalism
- Enables advanced diagnostic and sensor features

### Specifications

- **Mounting:** In valve box (recommended) or direct burial

#### • Power Draw:

- FD-101TURF: 0.5 mA (idle) 18 mA (per active solenoid)
- FD-102TURF: 0.5 mA (idle) 18 mA (per active solenoid)
- FD-202TURF: 1 mA (idle) 18 mA (per active solenoid)
- FD-401TURF: 1 mA (idle) 18 mA (per active solenoid)
- FD-601TURF: 1 mA (idle) 18 mA (per active solenoid)

#### • Dimensions:

- FD-101TURF: Length: 2.77 in. (70 mm), Diameter: 1.5 in. (40 mm)
- FD-102TURF: Length: 3.35 in. (85 mm), Diameter: 1.77 in. (45 mm)
- FD-202TURF: Length: 3.35 in. (85 mm), Diameter: 1.97 in. (50 mm)
- FD-401TURF: Length: 3.94 in. (100 mm), Diameter: 2.56 in. (65 mm)
- FD-601TURF: Length: 3.94 in. (100 mm), Diameter: 2.56 in. (65 mm)

#### • Solenoids:

- FD-101TURF: 1 with individual control
- FD-102TURF: 1 or 2 simultaneously
- FD-202TURF: 1 to 4 simultaneously
- FD-401TURF: 1 to 4 with individual control
- FD-601TURF: 1 to 6 with individual control

#### • Wires:

- FD-101TURF: Blue to cable, white to solenoid
- FD-102TURF: Blue to cable, white to solenoid
- FD-202TURF: Blue to cable, white and brown to solenoids
- FD-401TURF: Blue to cable, color-coded to solenoids
- FD-601TURF: Blue to cable, color-coded to solenoids



Decoders

## FD-TURF Two-Wire Decoders (cont.)

• **Surge Protection: One of the following is required every 500 ft. along two-wire path (40 V, 1.5 kW transil)**

- LSP-1 Line Surge Protector
- FD-401TURF with built in surge protection
- FD-601TURF with built in surge protection

**Note:** Minimum 10ohms resistance grounding required at controller and each surge protector

• **Input Fuse (FD-401TURF and FD-601TURF only):** 300-500 mA, thermal

• **Electrical Input:**

- Maximum voltage: 36 Vpp
- Maximum load:
  - FD-101TURF: 1 Rain Bird solenoid (one per address)
  - FD-102TURF: 2 Rain Bird solenoids (two per address)
  - FD-202TURF: 4 Rain Bird Solenoids (two per address)
  - FD-401TURF: 4 Rain Bird Solenoids (one per address)
  - FD-601TURF: 6 Rain Bird solenoids (one per address)

• **Decoder/Solenoid Wires:**

- Electrical resistance: Max. 3 ohms

• **Maximum Distance Decoder/Solenoids:**

- Cable length: 14 gauge, 456 feet

• **Wiring:** 2 x 14-gauge (1.5 mm<sup>2</sup>) solid copper, UF insulated type

• **Environment:**

- Working range: 32° to 122° F (0° to 50° C)
- Storage range: -4° to 158° F (-20 to 70° C)
- Humidity: 100%

**Note:** Rain Bird recommends using Rain Bird DB Series Wire Connectors (pg. 71) waterproof connectors for all connections.

**Note:** FD-Series Decoders are not compatible with residential valves like the Rain Bird HV, DV, DVF, ASVF, JTV, JTVF, and Drip Control Zone Kit with ASVF/DV valves

### Models

- **FD-101TURF:** Field Decoder interfacing signal line and valve
- **FD-102TURF:** Field Decoder interfacing signal line and valve or one pair of valves
- **FD-202TURF:** Field Decoder interfacing signal line and 2 valves or 2 pair of valves
- **FD-401TURF:** Field Decoder interfacing signal line and up to 4 individual valves
- **FD-601TURF:** Field Decoder interfacing signal line and up to 6 individual valves
- **LSP-1TURF:** Line Surge Protection
- **SD-210TURF:** Sensor Decoder interfacing signal line and analog or digital decoders

## DPU-210 Decoder Programming Unit

For ESP-LXD, MDC/MDC2 and SiteControl FD-Turf Two-Wire Decoders

- Decoder Programming Unit tests and verifies operation of the ESP-LXD, MDC/MDC2, or SiteControl FD Series Field Decoders. Also allows for re-programming decoder addresses for maximum site set-up flexibility



DPU-210

## TBOS-II™

Commercial Control for Battery-Powered Systems

### Features

- Convenient durable option for providing uninterrupted irrigation while AC-power is not available
- Field transmitter and control module have external optical connectors for easy plug-in
- Seven advanced programming features, the TBOS-II™ cuts setup time and eliminates repeat trips to the controller, resulting in water-efficient programs and lower operating expenses
- Master Valve: Extra support for stations that require a back-up to minimize water leaks or need extra water pressure
- Basic programming includes 3 independent programs with flexible days cycles including custom even, odd, odd-31 and 1-6 day program cycles for maximum flexibility
- 8 start times per program per day and Run-time from 1 minute to 12 hours in 1-minute increments
- Independent station operation allows simultaneous start times or sequential start times based on system hydraulic capacity
- One TBOS field transmitter programs an unlimited number of TBOS Control Modules
- Field transmitter and control module have external infrared connectors for easy plug-in
- ESP-LXD, and ESP-LX Modular Controllers

### Valve Compatibility

- TBOS potted latching solenoid is compatible with all Rain Bird valves in the DV, DVF, ASVF, PGA, PEB, PESB, GB, EFB-CP, BPE and BPES series
- The TBOS solenoid adapters will adapt the potted latching solenoid for use in retrofit applications with non-Rain Bird valves such as Irritrol® (Hardie/Richdel) and Buckner® valves or Champion® and Superior® valve actuators
- Tipping Rain Gauge wire: 18 – 26 awg

### TBOS-II Control Module

- Available in 4 models: 1, 2, 4 and 6 stations
- Operates one valve per station
- Station timing: 1 minute to 12 hours in 1-minute increments with a 365-day calendar. Stations can be assigned to multiple programs
- Active sensor connection accommodates Rain Bird® RSD-BEx Rain Sensor
- Operates with only one 9V alkaline battery (Energizer™ and Duracell™ are recommended) type 6AM6 (international standard) or 6LR61 (European standard): battery not included
- Battery life is one year with a high-quality 9V alkaline battery
- IP-68 rated waterproof case for reliable operation under water
- Dimensions: 3.8 x 5.1 x 2 inches (9.5 x 13.0 x 5.3 cm)
- Weight: 17.64 ounces (500 g)
- Maximum wire run between the module and solenoid:

Wire Size	Maximum Distance
18 AWG (0.75 mm <sup>2</sup> )	32 ft (10 m)
16 AWG (1.5 mm <sup>2</sup> )	100 ft (30 m)

- C-Tick approved

### TBOS-II Field Transmitter

- Field transmitter required for programming control module
- Dimensions: 2.8 x 6.3 x 1.2 inches (7.0 x 16.0 x 3.0 cm)
- Weight: 8.81 ounces (250 g)
- Operating temperature: 14 to 149° F (-10° to 65° C)
- C-Tick approved

### TBOS Potted Latching Solenoid

- Two 18 gauge (0.75 mm<sup>2</sup>) wires are supplied: 23.6 inches (60 cm) long
- Fits Rain Bird valves: DV, DVF, ASVF, PGA, PEB, PESB, GB, EFB-CP, BPE and BPES Series
- 150 psi (10 bar) maximum operating pressure
- Dimensions: 1.4 x 2.4 x 1.5 inches (4.0 cm x 6.0 cm x 4.2 cm)

### TBOS Solenoid Adapters

- Easy to install
- Black adapter for plastic valves allows the TBOS potted latching solenoid to be used with selected Irritrol (Hardie/Richel) and Buckner valves
- Brown adapter for brass valves allows the TBOS potted latching solenoid to be used with selected Champion and Superior valve actuators

### Models

- TBOS-II Control Modules:
  - TBOS2CM1: 1 station control module
  - TBOS2CM2: 2 station control module
  - TBOS2CM4: 4 station control module
  - TBOS2CM6: 6 station control module
- TBOS-II Field Transmitter:
  - TBOS2FTUS: Field Transmitter (US)
  - TBOS2FTSAU: Field Transmitter (AUS)



TBOS-II Control Module and Field Transmitter



TBOS Potted Latching Solenoid and Solenoid Adapters



Internet Connected Water Meters (ICWM)

## Internet Connected Water Meters (ICWM) NEW

Advanced Single-Jet Technology Water Meters

### Features

- 5 year data plan works anywhere the Verizon wireless network reaches avoiding costs of network integration.
- Digital register with web interface for water usage data collection and analysis including monthly water budgeting and over-usage alerts.
- Extreme low flow accuracy starting 0.1 gpm to easily identify leaks.
- Wide operating temperature range.
- Lead free NSF61 compliant.
- Low flow, backflow and high usage reports and alerts.
- 5 year data service plan + 5 year warranty included.
- Compact design for tight installations with no upstream or downstream straight pipe requirements.
- Single moving element and no strainer requirement for low maintenance.
- Brass body for durable, long-lasting performance.
- Unaffected by sand or small debris in line.
- High resistance to freezing.
- 100% submersible for flexible usage.
- ICWM075S durable composite plastic model also available with for long-lasting, maintenance free life

### Certifications

- FM Approved (ICWM600S).
- NSF Standard 61 Compliant.
- AWWA C712 Standard.

### Models

- ICWM075S: 5/8" with 1" NPSM end connection
- ICWM100S: 1" with 1.25" NPSM end connection
- ICWM150S: 1.5" with flange end connection
- ICWM200S: 2" with flange end connection
- ICWM300S: 3" with flange end connection
- ICWM400S: 4" with flange end connection
- ICWM600S: 6" with flange end connection
- ICWMREG: Universal Register Only

### Notes:

\* Spool connections are available to adjust lay length.

Dimensions, Weight, Materials, and Connection Size					
Model	Size (in)	Lay Length	Weight (lbs)	Body Material	End Connection
ICWM075S	5/8" x 3/4"	7.5"	1	Composite	1" NPSM
ICWM100S	1"	10.75"	5.6	Low lead Bronze	1.25" NPSM
ICWM150S	1.5"	7.87"	10	Low lead Brass	Oval Flange
ICWM200S	2"	9.78"	12	Low lead Brass	Oval Flange
ICWM300S	3"	11.8"	32	Low lead Brass	Round Flange
ICWM400S	3"/4"	13.75"	48	Lead free Bronze	3"/4" Flange
ICWM600S	4"/6"	17.75"	89	Lead free Bronze	4"/6" Flange

**Notes:**

\* Spool connections are available to adjust lay length.

Operating Specifications										
Model	Size (in)	Max Operating Pressure (PSI)	Min Test Flow (GPM)	Normal Op Range		Safe Max Op Capacity (GPM)	Max Cont Duty (GPM)	Head Loss @ SMOC (PSI)	Head Loss @ Max Cont Duty (PSI)	Standards Reference
				Min (GPM)	Max (GPM)					
ICWM075S	5/8" x 3/4"	230	0.0625	0.125	30	30	24	13	NA	"AWWA C712-15 NSF-61/372"
ICWM100S	1"	230	0.125	0.5	70	50	35	8	NA	
ICWM150S	1.5"	230	0.250	0.500	105	NA	88	7.25	NA	
ICWM200S	2"	230	0.250	0.75	165	NA	130	7.25	NA	
ICWM300S	3"	230	0.50	0.75	350	NA	175	7.25	NA	
ICWM400S	3"/4"	230	0.75	1.5	500	NA	350	7.25	NA	
ICWM600S	4"/6"	230	1.00	2.00	1000	NA	600	9.5	NA	



Large 8-digit display



Contractor Portal



Accurate Readings

## FMD Series Landscape Water Meters

Manage What You Measure!

### Features

- Lower cost than comparable brass flow meters and most plastic flow sensors.
- Passive management of irrigation using the meter's register dial.
- Delivers precise accuracy with flow ranges from 0.25 gpm to 160 gpm.
- Landscape Water Meter allows the property manager to avoid higher costs associated with tiered water rates.
- Landscape Water Meters are an integral part of an overall water efficient irrigation system.
- Supports California AB1881 and 20/20, LEED, Sustainable Sites Initiative, and the EPA WaterSense Program.
- Rebates offered by Water Agencies.
- Satisfies NSF/ANSI standard 61 Annex G.

### Mechanical Properties

- Multi-Jet Totalizing Landscape Water Meter with analog register dial readout (minimum volumetric resolution of 0.1 gallons).
- Brass body and glass-filled nylon construction provide maximum protection against high pressure surges, physical damage and corrosion.
- Not to be used with an unfiltered water source containing potential debris (lakes, ponds, wells, or other unfiltered sources).
- Exposing the Landscape Water Meter, full of water, to temperatures below freezing can lead to permanent damage. To winterize the meter, allow it to drain through a downstream drain valve.

### Models

- FM0625B: 5/8" with coupling inlet dimension x 3/4" NPT outlet.
- FM075B: 3/4" with coupling inlet dimension x 1" NPT outlet.
- FM100B: 1" with coupling inlet dimension of 1" NPT.
- FM150B: 1 1/2" with coupling inlet dimension of 1 1/2" NPT.
- FM200B: 2" with coupling inlet dimension of 2" NPT.



FMD Series Landscape Water Meters

### Rain Bird FMD Series Landscape Water Meters Suggested Operating Range

The following tables indicate the suggested flow range for Rain Bird FMD Series Landscape Water Meters. Rain Bird Sub-Meters will operate both above and below the indicated flow rates. However, good design practice dictates the use of this range for best performance. Landscape Water Meters should be sized for flow rather than pipe size.

FMD Landscape Water Meter Operating Specifications			
Model	Sub-meter Size	Flow Range	Body Thread (D)
FM0625B	5/8"	0.25 to 20 GPM	3/4" x 3/4"
FM075B	3/4"	0.50 to 30 GPM	1" x 1"
FM100B	1"	0.75 to 50 GPM	1" x 1"
FM150B	1 1/2"	1.5 to 100 GPM	1 1/2" x 1 1/2"
FM200B	2"	2.0 to 160 GPM	2" x 2"

#### Notes:

- Maximum operating pressure is 150 psi for all models.
- Maximum working water temperature is 80° F for all models.
- Maximum operating air temperature is 105° F for all models.
- Measurement accuracy at minimum flow is +/- 3% for each model.

FMD Landscape Water Meter Pressure Loss (psi)																			
Model	Sub-meter Size	1 GPM	5 GPM	7.5 GPM	10 GPM	15 GPM	20 GPM	25 GPM	30 GPM	40 GPM	50 GPM	60 GPM	70 GPM	80 GPM	90 GPM	100 GPM	120 GPM	140 GPM	160 GPM
FM0625B	5/8"	0.5	1.5	4.0	6.0	10.0	15.0	X	X	X	X	X	X	X	X	X	X	X	X
FM075B	3/4"	0.2	0.7	1.5	3.2	5.0	7.0	10.0	15.0	X	X	X	X	X	X	X	X	X	X
FM100B	1"	X	0.1	0.3	0.5	1.4	2.0	3.2	4.5	7.8	13.0	X	X	X	X	X	X	X	X
FM150B	1 1/2"	X	X	X	0.2	0.3	0.5	0.9	1.2	1.5	3.2	4.5	6.0	8.0	10.1	13.0	X	X	X
FM200B	2"	X	X	X	X	0.1	0.2	0.3	0.8	0.9	1.5	1.9	2.6	3.3	4.0	5.0	7.0	9.6	13.0

## Flow Sensors and Transmitters

Maxicom<sup>2</sup>®, SiteControl, IQ, ESP-LX Series Controllers or IQ™

### Features (Sensors)

- Simple six-bladed impeller design
- Designed for outdoor or underground applications
- Available in PVC, brass or stainless steel construction
- Pre-installed in tee or saddle mounted insert versions

### Operating Specifications (Sensors)

- Accuracy: +- 1% (full scale)
- Velocity: 1/2-30 feet (0.15 - 9.2 meters) per second depending on model
- Pressure: 400 psi (27.5 bars) (max) on metal models; 100 psi (6.9 bars) (max) on plastic models
- Temperature: 220° F (105° C) (max) on metal models; 140° F (60° C) (max) on plastic models

### Features (Transmitters)

- Programmable from a computer (PT322 – Maxicom and SiteControl Systems only – not required for ESP-LXMEF or ESP-LXD)
- Reliable solid-state design, available with or without LCD display
- Operates with MAXILink™ and (hard-wire) two-wire satellite systems
- Easy-to-program, menu-driven design
- Mounted in optional NEMA enclosure (PT3002 only)

### Operating Specifications (Transmitters)

- Input required:
  - 12-30 VDC/VAC on PT322
  - 12-24 VAC/VDC on PT 3002
- Output: Pulse output
- Operating Temp: -4° F-158° F (-20° C to 70° C)
- Units: Domestic and International units available on PT3002

### Dimensions

- PT322: 3.65" x 1.75" x 1.0" (93mm x 44mm x 25mm)
- PT3002: 3.78" x 3.78" x 2.21" (96mm x 96mm x 56mm)
- FS100P: 3.50" x 3.94" x 1.315" (89mm x 100mm x 33mm)
- FS150P: 5.0" x 5.16" x 2.38" (127mm x 131mm x 60mm)
- FS200P: 5.63" x 5.64" x 2.88" (143mm x 143mm x 73mm)
- FS300P: 6.50" x 6.83" x 4.23" (165mm x 173mm x 107mm)
- FS400P: 7.38" x 7.83" x 5.38" (187mm x 199mm x 137mm)
- FS100B: 5.45" x 4.94" x 2.21" (138mm x 126mm x 56mm)
- FS150B: 6.5" x 5.19" x 2.5" (165mm x 132mm x 64mm)
- FS200B: 4.25" x 8.35" x 2.94" ( 108mm x 212mm x 75mm )
- FS350B: 7.13" x 3"(diameter) (181mm x 76mm (diameter))
- FS350SS: 7.13" x 3"(diameter) (181mm x 76mm (diameter))

### Configuration

- **For ESP-LXD Decoder Systems**, the Flow Sensor is installed with a Two-Wire Decoder Sensor Decoder (SD210TURF)
- **For ESP-LXMEF Systems**, the Flow Sensor is attached to the FSM-LXME Flow Smart Module
- **For (Hard Wire) Two-Wire Satellite Systems (Maxicom<sup>2</sup> and SiteControl)**, the Flow Sensor is installed with a Pulse Transmitter and a Rain Bird Pulse Decoder (DECPULLR)
- **For Link Radio Satellite Systems (Maxicom<sup>2</sup> and SiteControl)**, the Flow Sensor is installed with a Pulse Transmitter (no pulse decoder required)
- **For ESP-SITE Satellite Systems (Maxicom<sup>2</sup>)**, the Flow Sensor is installed with a Pulse Transmitter (no decoder required)
- **For SiteControl Decoder Systems**, the Flow Sensor is installed with a Two-Wire Decoder Sensor Decoder (SD210TURF)
- Surge protection (FSSURGEKIT) is recommended for Maxicom & SiteControl systems – One at the Pulse Transmitter, and if more than 50' of wire run, one at the Flow Sensor. FSSURGEKIT is not compatible with ESP-LXMEF and ESP-LXD Controllers

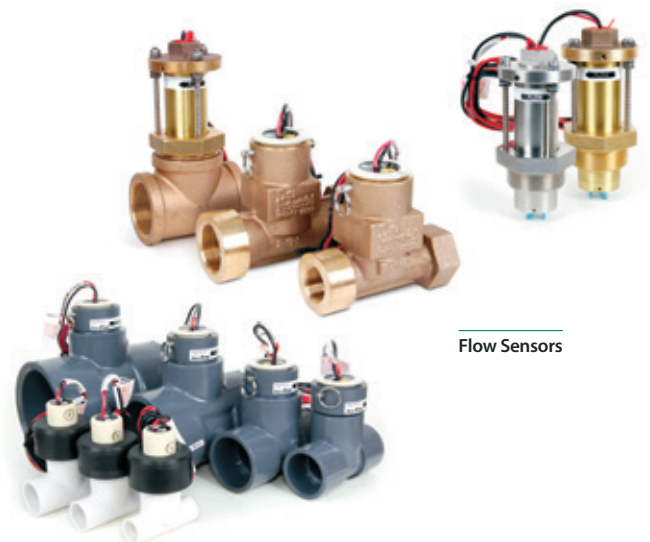

Flow Sensors



Flow Sensor Transmitters and Accessories

## Flow Sensors and Transmitters (cont.)

### Models

#### Brass TEE's

- FS200B: 2" (50mm) Brass Tee Flow Sensor
- FS150B: 1 1/2" (40mm) Brass Tee Flow Sensor
- FS100B: 1" (25mm) Brass Tee Flow Sensor

#### Plastic TEE's

- FS400P: 4" (110mm) PVC Tee Flow Sensor
- FS300P: 3" (75mm) PVC Tee Flow Sensor
- FS200P: 2" (50mm) PVC Tee Flow Sensor
- FS150P: 1 1/2" (40mm) PVC Tee Flow Sensor
- FS100P: 1" (25mm) PVC Tee Flow Sensor

#### Inserts

- FS350SS: 3" and higher, Stainless Steel Insert
- FS350B: 3" and higher, Brass Insert
- FSTINSERT: Replacement insert for Tee type sensors

#### Pulse Transmitters (not necessary with ESP-LX Controllers)

- PT322: Pulse Transmitter, no display
- PT3002: Pulse Transmitter, LCD display

#### Accessories

- PTPWRSUPP: Pulse Transmitter power supply
- NEMACAB: NEMA Enclosure for PT3002
- FSSURGEKIT: Flow Sensor surge protection kit
- DECPULLR: Pulse Decoder for two-wire satellites
- SD210TURF: Sensor Decoder for decoder systems
- FSMLXME: Flow Smart Module for ESP-LXME Series Controllers

### Rain Bird Flow Sensor Suggested Operating Range

The following tables indicate the suggested flow range for Rain Bird Flow Sensors. Rain Bird Sensors will operate both above and below the indicated flow rates. However, good design practice dictates the use of this range for best performance. Sensors should be sized for flow rather than pipe size.

Model	Suggested Operating Range (Gallons / Minute)	Suggested Operating Range (Liters / Minute)	Suggested Operating Range (Cubic Meters / Hour)
FS100P	5.4 - 54	20 - 200	1.2 - 12
FS150P	5 - 100	19 - 380	1.1 - 23
FS200P	10 - 200	40 - 750	2.3 - 45
FS300P	20 - 300	75 - 1130	4.5 - 70
FS400P	40 - 500	150 - 1900	9 - 110
FS100B	2 - 40	7.6 - 150	0.5 - 9
FS150B	4 - 80	15 - 300	1 - 18
FS200B	10 - 100	38 - 380	2.3 - 23
FS350B	Depends on Pipe Type and Size - please reference Flow Sensors tech spec		
FS350SS			

## RSD-BEx / RSD-CEx

### Wired Rain Sensor

#### Features and Benefits

- Automatic rain shutoff prevents overwatering due to natural precipitation
- Robust, reliable design reduces service call backs
- Moisture sensing disks work in a variety of climates
- Different sensor mounts permit speed and flexibility on the job site
- Latching hinge maintains alignment

#### Mechanical Properties

- Multiple rainfall settings from 1/8" - 3/4" (5 - 20 mm) are quick and easy with just the twist of a dial
- Adjustable vent ring helps control drying time
- High-grade, UV resistant polymer body resists the elements
- Available in rugged bracket version (RSD-BEx model comes with 5" latching aluminum bracket) or conduit version (RSD-CEx) for a clean and professional look
- Not compatible with ESP-SMT or ESP-SMTe controllers

#### Electrical Specifications

- Application: Suitable for low voltage 24 VAC control circuits and 24 VAC pump start relay circuits\*
- Switch electrical rating: 3A @ 125/250 VAC
- Capacity: Electrical rating suitable for use with up to ten 24 VAC, 7 VA solenoid valves per station, plus one master valve
- Wire: 25' (7.6 m) length of #20, 2 conductor UV resistant extension wire
- UL, cUL listed; CE, C-Tick approved

\* Not recommended for use with high voltage pump start, pump start relay circuits or devices.

#### Dimensions

- RSD-BEx
  - Overall length: 6.5" (16.5 cm)
  - Overall height: 5.4" (13.7 cm)
  - Bracket hole pattern: 1.25" (3.2 cm)
- RSD-CEx
  - Overall length: 3" (7.6 cm)
  - Overall height: 2.75" (7 cm)

#### Models

- RSD-BEx: Rain sensor w/ latching bracket, extension wire
- RSD-CEx: Rain sensor w/ threaded adapter, extension wire



### How To Specify

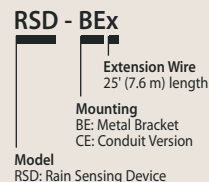



## WR2 Series Wireless Rain + Freeze Sensors

Superior responsiveness to rainfall and cold temperatures, save up to 35% on water usage

### Features & Benefits

- Enhanced antenna array provides superior signal reliability that overcomes most line-of-sight obstructions
- Sensor signal strength indicator enables one person set up, reducing installation time
- Convenient adjustment and monitoring of rain or freeze settings at the controller interface
- Simple battery replacement requiring no tools or need to disassemble sensor
- Highly intuitive icon-driven controller interface simplifies programming
- Easy to install, self-leveling sensor bracket mounts to flat surfaces or rain gutters
- Antennas concealed within the units for greater visual appeal and product robustness
- "Quick Shut Off" interrupts active irrigation cycle during a rain event

### Electrical Specifications

- Application: suitable for use with 24 VAC controllers (with or without pump start / master valve)
- Electrical rating suitable for use with up to six 24VAC 7VA solenoids plus an additional master valve or pump start that does not exceed 53VA
- Controller Interface Wire: 30" (76 cm) length of #22 gauge (0.64 mm) UV resistant extension wire
- Certifications: UL, cUL, CE, C-Tick, and WEEE
- FCC approved spread spectrum 2 way radio transceivers with FCC Class B approvals
- Signal transmission distance of 700' (213.4 m) Line of Sight
- Battery life: four or more years under normal operating conditions
- 6 KV surge / lightning protection

### Mechanical Properties

- Adjustable rainfall settings from 1/8" – 1/2" (3 – 13 mm)
- Adjustable low temperature settings from 33°F – 41°F (0.5° – 5°C)
- Three irrigation modes to select: Programmed, Suspend Irrigation for 72 hours, Override sensor for 72 hours
- Note:** The WR2-48 model replaces the Suspend Irrigation for 72 Hours mode with 48-Hour Irrigation Hold Active mode.
- "Quick Shut Off" suspends active irrigation cycle within approximately two minutes
- High-grade, UV resistant polymer units resist harmful environmental effects

### Models

- North America (916 MHz)
  - WR2-RFC: Rain + Freeze Combo
  - WR2-RFI: Rain + Freeze Controller Interface only
  - WR2-RFS: Rain + Freeze Sensor Only
  - WR2-48: Rain + Freeze Combo with 48-hour hold
- International (868 MHz)
  - WR2-RFC-868: Rain + Freeze Combo



WR2 Series Wireless Rain/Freeze Sensors

#### Step 1



Program in seconds

#### Step 2



Determine best sensor location

#### Step 3



Install sensor easily using mounting bracket

## SMRT-Y Soil Moisture Sensor Kit

Accurate • Reliable • Smart

### Features and Benefits

- Turns any controller into a water saving smart controller
- Healthier landscapes less prone to nutrient depletion, fungus and shallow root growth
- Typical water savings exceed 40%
- TDT digital sensor enables highly accurate readings that are independent of soil temperature and electrical conductivity (EC)
- Displays soil moisture content, soil temperature and EC
- Corrosion-resistant in-ground sensor made of high-grade 304 stainless steel

### Operating Specifications

- 25 Volts AC at 12W
- Operating temperature: -4°F to 158°F (-20°C to 70°C)
- Survival temperature: -40°F to 185°F (-40°C to 85°C)
- Certifications: UL, CUL, C-TICK

### Dimensions

#### • Controller Interface

- W: 3.0" (76mm); H: 3.0" (76mm); D: 0.75" (19mm)

#### • In-Ground Soil Moisture Sensor (without wires)

- W: 2.0" (50mm); L: 8.0" (200mm); D: 0.5" (12mm)

- 18 AWG wire leads @ 42 in. (106.7 cm) length

### SMRT-Y Kit

#### • Includes

- Controller Interface
- In-Ground Soil Moisture Sensor
- Anodized, rust-proof screws, 1.5" (two per package)
- Wire nuts – 5 blue, 2 gray, 1 yellow
- Multilingual instruction manual, "Quick Start" Guide and Soil Moisture sticker

### Models

- SMRT-Y: Soil Moisture Sensor Kit
- **NEW FOR 2018:** All SMRT-Y models are RoHS compliant

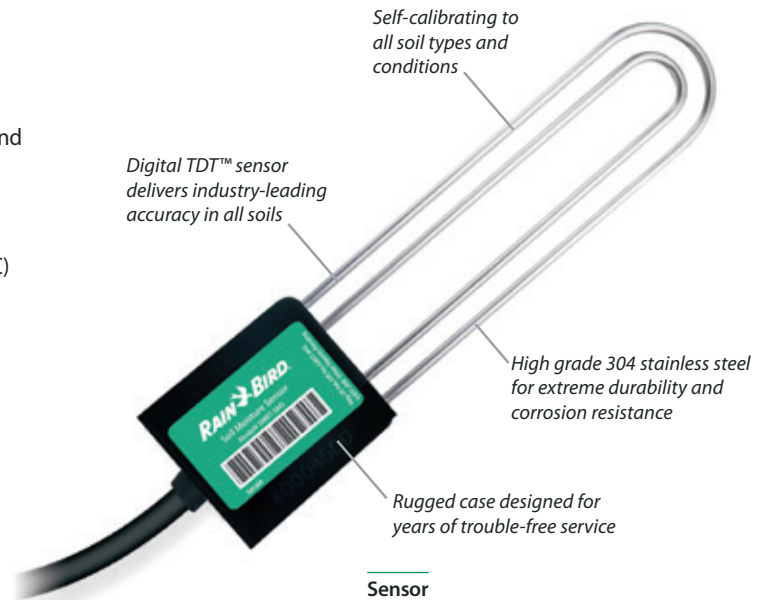

Sensor

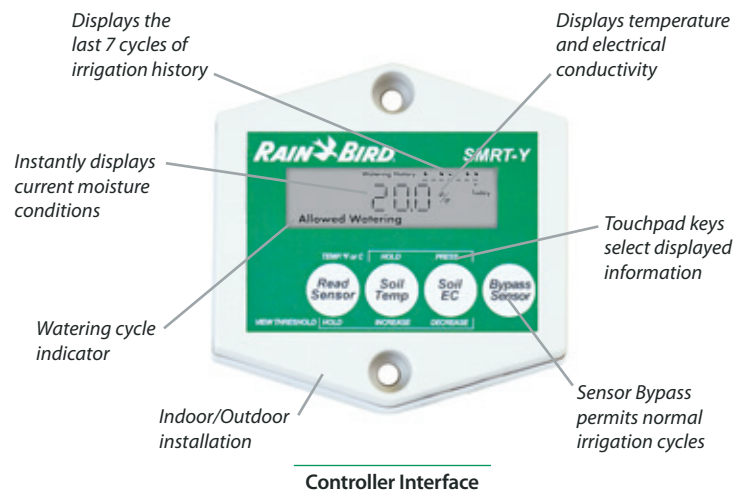

Controller Interface

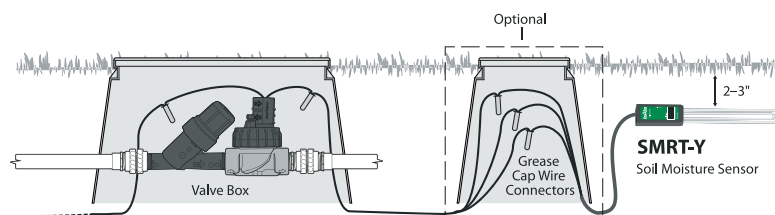
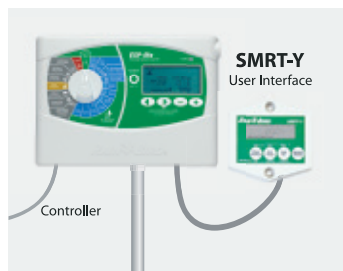



*“The best thing about IQ-Cloud is being able to share access with our irrigation techs as well as our clients. Our clients have been asking for a web-based solution and the flexible, easy to use IQ-Cloud is definitely the answer to this question. Using IQ-Cloud with weather data from a weather station or IQ Global Weather provides a seamless solution for effective ET management.”*

**Scott Simeon**, Director of Water Management  
AAA Landscape



## Water Saving Tips

- Maxicom<sup>2</sup>, SiteControl, and IQ<sup>™</sup> Systems provide fully-automated ET (evapotranspiration) adjustment of irrigation programs for maximum water savings.
- Maxicom<sup>2</sup> and IQ<sup>™</sup> FloWatch<sup>™</sup> utility monitors and records real-time flow and automatically diagnoses and eliminates flow problems caused by broken pipes, vandalism or stuck valves.
- The New Rain Bird<sup>®</sup> IQ<sup>™</sup> Platform. The ultimate tool for remote water management. With no hidden fees, It's the perfect remote water management solution. With the new IQ-Cloud v. 3.0, you can control your irrigation system from any device, anywhere. With set up that takes less than five minutes, multi-user access and no recurring annual fees, you finally have the option you've been waiting for. Visit [www.rainbird.com/iq](http://www.rainbird.com/iq) and take control now.

Introduction

Spray Bodies

Spray Nozzles

Rotors

Valves

Controllers

Central Controls

Landscape Drip

Pumps & Filtration

Drainage Products

Resources

## Major Products

System Name	IQ™ v3.0	SiteControl	Maxicom®
System Type	<b>Modular multi-site central control system</b>	<b>Modular single site central control system</b>	<b>Multi-satellite central control system</b>
Traditionally wired or two-wire decoder	Works with both	Works with both	Traditionally wired
Typical applications	Multi-site management with modular features. Ideal solution for water managers, schools, parks, corporate campuses and transportation departments	Single site management with modular features. Ideal for large resorts, cemeteries, shopping centers, theme parks and sports stadiums	Multi-site commercial or industrial irrigation applications. Ideal for municipalities, school districts, homeowner associations and park and recreation departments
Number of sites/system	999	1	200+
Local and/or remote site control	Local and remote	Local	Local and remote
Maximum number of simultaneous stations per site/system	5 per ESP-LXME 8 per ESP-LXD	3,584 per site	112 per CCU
Number of ET (weather) sources	100	4	16
Program adjustments by ET	Yes	Yes	Yes
Program adjustments by percentage	Yes	Yes	Yes
Programming by volume/gallons	No	No	Yes
Number of programs	4 per satellite	100 total per system	999 per CCU
Flow management capabilities	Yes	Yes	Yes
Flow monitoring/recording capabilities	Yes	Yes	Yes
High-flow shutdown	Mainline and laterals	Mainline only	Mainline and laterals
Low- or zero-flow shutdown	Mainline and laterals	No	Mainline and laterals
Alarms/warnings	Yes	Yes	Yes
Sensor input and manual bypass	Yes	Yes	Yes
Number of weather sensor inputs	One per ESP-LXME Four per ESP-LXD	Up to 200 sensor inputs per system	Up to 56 per CCU
Number of flow sensor inputs	One per ESP-LXMEF Five per ESP-LXD	Up to 200 sensor inputs per system	Up to 6 (two wire) or 20 (Link) per CCU
Software/password log-on protection	Yes	N/A	Yes
Remote control capabilities	Yes, IQ Mobile	Yes, Freedom System	Yes, Freedom System
Cycle+Soak™	Yes	Yes	Yes
Water window by program/schedule	Yes	Yes	Yes
Computer included with software	No	Yes	Yes
Computer programming	Yes	Yes	Yes
24/7 system monitoring	Yes, by the controller	Yes, by the computer	Yes, by the CCU
24/7 communication & feedback	No	Yes, computer to satellites and decoders	CCU to satellite
Remote site telephone, cellular, radio, Ethernet, Wi-Fi communication	All	No	All
Automatic remote site communication	Yes	No	Yes
Satellite controllers or decoders	ESP-LXME or ESP-LXD Satellites	ESP-SAT Satellites or FD-Series Decoders	ESP-SAT or ESP-SITE Satellites
Modular station capacity	ESP-LXME: 8-48 ESP-LXD: 50-200	No	No
Number of site/system interfaces	N/A – No interfaces required	8	>200
Number of satellites/system	16,000+	896	>5,600
Number of satellites/site interface	Up to 150 satellites per IQNet	Up to 112 per TWI	Up to 28 per CCU
Number of satellite stations/site	ESP-LXME: Up to 7,200 per IQNet ESP-LXD: Up to 30,000 per IQNet	Up to 21,504 per system	Up to 672 per CCU
Number of decoder addresses per site	Up to 30,000 per IQNet	Up to 4,000	N/A
Interactive map interface	No	Yes	No
GPS, CAD, SHP, BMP Import	N/A	Yes	BMP, PDF, JPEG
Valve control: stations or decoders	Both	Both	Satellite stations only
Estimated/actual water use report	Yes	Yes	Yes
Event recording (station operation)	Yes	Yes	Yes
Projected operation (dry/run) capability	Yes	Yes	Yes
Supported by Global Services Plan	Yes	Yes	Yes
Can also manage lighting and security systems	Yes	Yes	Yes

## IQ™ v3.0 Central Control Software NEW

Modular Multi-Site Central Control

The IQ Platform offers state-of-the-art command and control features in an easy to learn and use interface. IQ provides advanced water management features saving money and time. The IQ Platform consists of three options: IQ-Desktop v. 3.0, IQ-Cloud v. 3.0, and IQ-Enterprise v. 3.0.

### Applications

All IQ versions provide remote programming, management, and monitoring of ESP-LX Series Controllers from the computer in your office. IQ is the perfect irrigation control solution for parks departments, school districts, property managers, landscape maintenance contractors, and water managers. IQ can manage small single-controller sites as well as large multi-controller sites and supports both ESP-LX Series traditionally-wired and 2-wire decoder controllers.

IQ-Desktop is installed and operated on a single desktop computer. IQ-Desktop is ideal for organizations with one administrator who can control the system from their computer in their office. The IQ-Desktop software package provides 5-satellite controller capacity. IQ software satellite controller capacity can be upgraded in 5-satellite increments with the IQ5SATSWU.

IQ-Cloud is a cloud based service allowing users to login and control their irrigation system from any internet connected device.

IQ-Cloud is ideal for organizations with multiple irrigation system administrators and/or users that require mobility. IQ-Cloud features IQ-Mobile which provides quick access to key features in an interface designed for touchscreen devices found in smartphones or tablets. Users are not restricted to an initial capacity and can add satellites at will. Internet access is required.

IQ-Enterprise is installed on a server and enables organizations with internet access security/restrictions and a robust local area network to install their own private IQ-Cloud. Users can get all the mobility benefits of IQ-Cloud and comply with IT restrictions. IQ-Enterprise software package provides 5-satellite controller capacity. IQ software satellite controller capacity can be upgraded in 5-satellite increments with the IQ5SATSWU.

### IQ Platform Software Features

- Software 5-satellite controller capacity upgradable in 5-satellite increments (Desktop & Enterprise)
- Compatible with ESP-LXM & ESP-LXME traditionally-wired and ESP-LXD 2-wire decoder controllers

Visit [www.rainbird.com/iq](http://www.rainbird.com/iq) to learn more about the features included the IQ Platform.

#### • Additional 5-Satellite Capacity Upgrade

- IQ Software satellite controller capacity can be upgraded in 5-satellite increments
- Additional capacity is added through a purchased software activation keycode

### Recommended Computer Requirements for IQ-Desktop

- Operating System: Windows® XP, 7 or 8, 32-bit or 64-bit
- Processor: Intel I5-540M or equivalent
- RAM Memory: 3 GB
- Available Hard Disk Space: 10 GB
- CD-ROM Drive: 8X speed minimum
- Display Resolution: 1024 x 768 minimum
- Network Connection (for Ethernet, WiFi, GPRS)
- Serial Port or USB to Serial Adapter (for Direct Connect and External Modem communication)
- Operating System: Windows® XP, 7 or 8, 32-bit or 64-bit

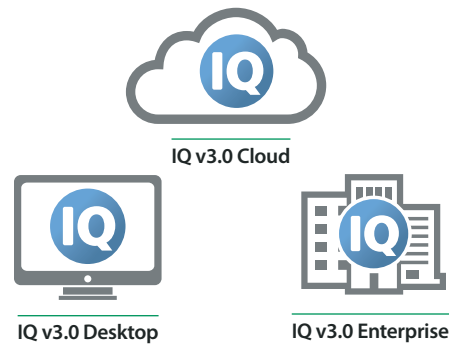

Central Controls

### How To Specify

#### **IQ V3.0 SOFTWARE**

- IQADVCECD: 5-Satellite Capacity with advanced feature packs included
- IQ5SATSWU: Software 5-Satellite Capacity Upgrade

## IQ NCC Network Communication Cartridge

Upgrades any ESP-LX Series Controller to an IQ Central Control Satellite Controller

### Features

- IQ is the perfect irrigation control solution for parks departments, school districts, property managers, landscape maintenance contractors and water managers. IQ can manage small single-controller sites as well as large multi-controller sites. IQ NCC cartridges are compatible with the ESP-LXME Controller with 1- to 48-station capacity and ESP-LXD Decoder Controller with 1- to 200-station capacity
- IQ NCC cartridges are initially configured through a setup wizard provided in the ESP-LX Series Controller IQ Settings dial position. Communication setting parameters are configured through the IQ software or the NCC Configurator Software designed for netbook/laptop use on the job site

### Direct Satellites

- Single controller sites would use an IQ NCC cartridge configured as a Direct satellite. A Direct satellite has an IQ central computer communication connection but no network connections to other satellites in the system

### Server & Client Satellites

- Multi-controller sites would use one IQ NCC cartridge configured as a Server satellite and the other NCC cartridges configured as Client satellites. The Server satellite has an IQ central computer communication connection and shares this communication connection with the Client satellites through high-speed data cable or radios. The communication connection between Server and Client satellites is called the IQNet™
- Satellites on a common IQNet can share weather sensors and master valves
- Server and Client satellites using high-speed data cable for IQNet communication require installation of an IQ CM Communication Module. Server and Client satellites using radio communication for IQNet communication require installation of an IQSSRADIO radio. Each cartridge kit includes cables to connect the NCC cartridge to connection module and/or radio

### IQ NCC 3G Cellular Cartridge

- Includes embedded 3g/Cellular Data Modem with antenna connector
- Includes internal antenna for plastic controller enclosures (optional external antenna available for metal case controller enclosures)
- Requires Cellular data service plan with static IP address from Cellular Service Provider
- Available with 1st year of communication service included. Cartridge with included communication service not offered in all areas

### IQ NCC-EN Ethernet Cartridge

- Includes embedded Ethernet Network Modem with RJ-45 port
- Includes RJ-45e patch cable (requires LAN network static IP address)

### IQ NCC-RS RS232 Cartridge

- Includes RS-232 Port for IQ Direct Cable or External Modem communication connection to the IQ central computer, and external modem cable (IQ Direct Cable provided with IQ Software Package)
- Used for Direct or Server Satellite applications requiring direct cable connection or external modem (radio or other 3rd-party device) communication with the IQ central computer, and for Client Satellite applications requiring IQNet high-speed data cable or radio communication with the Server Satellite

### IQ FSCM-LXME Flow Smart Connection Module

- Provides IQNet high-speed data cable connections for ESP-LXME Controller
- Includes Flow Smart Module and Base Module functions
- Replaces standard ESP-LXME Base Module

### IQ CM-LXD Connection Module

- Provides IQNet high-speed data cable connections for ESP-LXD Controller
- Installs in ESP-LXD 0 (zero) module slot

### IQ SS-Radio Radio Modem

- Provides IQNet wireless radio communication between Server and Client satellite controllers
- Can also be used with the IQ NCC-RS RS232 Cartridge for IQ central computer to Direct or Server satellite radio communication
- Includes power supply and external antenna (programming software and cable provided separately)



IQ NCC Network  
Communication Cartridge

## SiteControl

A Full-Featured Central Control System for Single Site Applications

### Features

- Advanced Graphical Tracking- Maps generated by GPS technology or AutoCAD recreate your site. Interactive mapping and on-screen graphics show your complete site with location of individual valves and sprinklers allows you to measure and calculate areas from your map
- Smart Weather™ is designed to take complete advantage of Rain Bird's most advanced line of weather stations, tracks ET and rainfall via a weather station and reacts to current weather conditions based on user-defined options. Advanced warning system accepts user-defined sensor thresholds. System operator is immediately alerted if thresholds are exceeded
- RainWatch™ uses tipping bucket rain can(s) to detect and suspend irrigation while measuring rainfall. When rain stops, irrigation resumes with run times reduced according to measured rain
- Minimum ET- allows setting minimum ET threshold values for irrigation to take place. Promotes deep watering for optimum turf conditions
- Automatic ET automatically adjust run times in relation to fluctuations in Evapotranspiration (ET) values
- Remote System Control allows you to take control of your system and operate SiteControl from anywhere on your site using the Rain Bird FREEDOM System. Phone (landline or cellular) or radio communication options
- Hybrid System operates Satellite Controllers and/or Two-Wire Decoders
- SiteControl Plus operates four Large Decoder Interfaces (LDI), each capable of operating up to 1,000 solenoids with Hybrid system, can further expand capabilities by combining Two-Wire Decoder and/or Satellite Controller options up to four total interface devices

### Superior Monitoring and Scheduling

- Flo-Graph™ allows visibility of real-time graphics with individual station information presented in colorful charts
- Flo-Manager™ balances system demands and maximum capacities with efficiency helping to lower water demand, reduce system wear and tear and save energy
- Cycle + Soak™. Better control the application of water on slopes and in areas with poor drainage
- QuickIRR™ Quick and easy method to build irrigation schedules and programs based on your parameters

### Other Features

- Up to 200 points of connection
- Up to 200 pulse sensors
- Water usage logs
- Station run-time logs
- Posted and dry run logs
- ET spreadsheet
- 1 year Global Service Plan included

### Models

- SCON: Desktop PC with SiteControl software, includes 1 year Global Support Plan (GSP)

### Software Module Options

- Smart Weather
- Rain Bird Messenger (for Smart Weather)
- Automatic ET
- Hybrid Module
- Smart Sensor
- Map Utilities
- Freedom
- 8 Additional Locations
- Additional Wire-Path (2nd)
- Additional Wire-Path (3rd)
- Additional Wire-Path (4th)
- SiteControl Plus
- Smart Pump
- MI (Mobile Interface)

### Global Service Plan (GSP)

- Visit [rainbird.com/gsp/index.htm](http://rainbird.com/gsp/index.htm) for more information.



SiteControl

## SiteControl Hardware

### TWI Satellite Interface

- Allows real-time, two-way communication between SiteControl Central Controller and field satellites
- Allows use of advanced in-field capabilities of ESP-SAT twowire or LINK versions
- Modular capacity can grow with the site

### Two-Wire Decoder Interface

- Allows real-time, two-way communication between SiteControl Central Controller and decoders
- Connects the powerful capabilities of SiteControl with the ease of installation and security of a two-wire decoder system
- System can be set up and expanded according to project needs

### ESP-SAT Satellite Controller

- 24, 40 Stations Satellite Controller
- Field Satellite Controller for Maxicom<sup>2</sup> or SiteControl Central Control systems
- The power of an advanced water-management tool, in an easy-to-use package
- All the features and stand-alone capabilities of the Rain Bird ESP-MC Controller line

### Spread Spectrum Radio

- Frequency hopping to avoid interference
- Reduced cost of ownership, no FCC license required
- No FCC restrictions on antenna height (User should check local laws)
- Radios can be set up as repeater to achieve great distances and overcome obstacles

### Ethernet Devices

- Use Ethernet networks to:
  - Communicate from Central Control Computer to CCUs, SiteSats, TWIs and weather stations
  - Communicate from CCU and TWIs to ESP-Sats

### Freedom for Central Control

- Uses standard telephone interface
- Single cellular phone can control entire central control system
- Standard land-line telephones can also control system



TWI Interface



ESP-SAT Satellite Controller



ESP-MIB-TW



DEC-SEN-LR DEC-PUL-LR

### WS-PRO Weather Stations

- Scientific accuracy sensors located three meters above the ground for added vandal-resistance
- Powerful, internal micro-logger for climatic data collection, logging and analysis, constant communication with weather sensors, and storage of 30 days of data
- Rugged yet lightweight metal construction;

### Sensor-Pulse Decoders

- Complete feedback system
- Extends central control system versatility
- Color-coded wire leads for ease of installation
- Programmable address codes for individual operation

### RAINGAUGE Rain Sensor

- Accurate rain counter switch counts rainfall in 1/100th inch increments
- Heavy-duty metal construction
- Mounting bracket
- Debris screen

### ANEMOMETER Wind Sensor

- Accurate wind speed measurement for high-wind shutdown or interrupt of irrigation programs
- Heavy-duty metal mounting bracket
- Requires PT322 or PT3002 Pulse Transmitter for use with Maxicom<sup>2</sup> System

### Maxi Interface Boards

- Upgrades an ESP-MC Controller (wall mount or pedestal) to an ESP-SAT Satellite Controller
- No additional enclosures or external wiring required
- Installs on stand-offs on controller output board

### MSP-1 Surge Protection

- Protects central control components from electrical surges on a two-wire communication path
- Can be installed in satellite or CCU pedestal or in valve box in conjunction with MGP-1 (Maxicom<sup>2</sup> Grounding Plate)

### MGP-1 Surge Grounding Plate

- Provides a mounting location for MSP-1 or other grounding wires directly to a grounding rod or pipe
- Installed on grounding rod or pipe



**Maxicom<sup>2</sup><sup>®</sup> version 4.4 now available** **NEW**

Multi-Site Central Control Ideal for Large Commercial Systems

**New for version 4.4**

- Windows 8 compatibility
- Seek & Eliminate Low Flow (SELF) – Automatically diagnose a low flow problem
- Station Lockout – Quarantine zones that have had high/low flow alarms until the user takes action
- Station Priorities for Flow Manager – allows the user to alter the sequence of irrigation zones by assigning priorities when flow manager is being used
- Queued irrigation max run time limit increased from 99 minutes to 999 minutes
- Adjustable rain can settings
- Seek & Eliminate Excessive Flow (SEEF) improvement to account for manual adjustments
- Database trim setting is no longer fixed and is user-selectable so users can decide how far back the records go
- Phone number/address field works with URL's and longer IP Addresses
- Field Device Configuration Report now includes satellite names and sensor names

**System Features**

- Maxicom<sup>2</sup><sup>®</sup> Central Controller Package comes with Maxicom<sup>2</sup> software, pre-configured computer, Global Service Plan (GSP), and training
- Control hundreds of ESP-SITE-SAT Satellites (single controller sites) and Cluster Control Units (CCUs) which can each control up to 28 individual ESP-SAT Satellite Controllers on multi-controller sites
- Monitor dozens of Weather Sources including WSPRO2 Weather Stations, ET Managers, or rain counting sensors (Raingauge)
- Freedom Remote Control allows manual operation of system through a cellular phone or radio
- Multiple log and water usage reports are generated automatically to track system operation and water savings

**Water Management Features**

- Cross satellite schedule operation; 999 separate schedules per CCU provides precision watering of areas and microclimates
- ET Checkbook™ manages Evapotranspiration (ET) and automatically adjusts Satellite Controller station run-time or day cycle intervals to match the landscapes water requirements
- FloManager™ manages the total flow demand placed on the water source(s), optimizing both the available water and watering window
- FloWatch™ monitors flow sensors at each water source, records flow, and automatically reacts to problem flows by shutting down the effected portion of the system (individual valve or mainline)
- RainWatch™ monitors rain counting sensors, records rainfall, and automatically reacts to rainfall by interrupting irrigation, waiting to see how much rain has fallen, and determines if the irrigation should be resumed or cancelled

**Operational Features**

- Communication Control Engine automatically sends updated programming to sites before watering begins and retrieves logs after irrigation is completed; manual operation can be performed at any time
- Start day cycles: Custom (day of the week), Odd/Even, Odd31, or Cyclical and include Event Day Off Calendar scheduling
- Station run-times programmable from 1 minute to 16 hours
- Cycle + Soak™ optimizes water application to soil infiltration rate, reducing runoff and puddling
- Control non-irrigation functions such as lighting, fountains, door locks and gates

**Maxicom<sup>2</sup> Communications Options**

- Central Controller to CCU: Phone, direct connect, radio, cellular, network (Ethernet, Wi-Fi, fiber-optics)
- CCU to ESP-SAT2: Two-wire path
- CCU to ESP-SATL: Radio, MasterLink, network (Ethernet, Wi-Fi, fiber-optics)

**Global Service Plan (GSP)**

- Visit [rainbird.com/gsp/index.htm](http://rainbird.com/gsp/index.htm) for more information.

**Models**

- MC2GOLD1: New System - Desktop PC with Maxicom software, includes 1 year Global Support Plan (GSP)
- GSPMCP3: Current GSP Or Expired GSP Subscribers, Desktop PC with Maxicom software, includes 3 Years Platinum Plus Global Support Plan
- GSPMXPPCIA: Current GSP Subscribers, Desktop PC with Maxicom software, based on 3 Year Platinum Plus Global Support Plan, includes year 1 GSP, requires year 2 and 3 GSP to be purchased separately (M95543A2)
- GSPMXPPCIM: Current GSP Subscribers, Desktop PC with Maxicom software, based on 3 Years Platinum Plus Global Support Plan, includes month 1 GSP, requires month 2 - 36 GSP to be purchased separately (M95544M2)
- GSPMXPPNIA: New GSP or Expired GSP Subscribers, Desktop PC with Maxicom software, based on 3 Years Platinum Plus Global Support Plan, includes year 1 GSP, requires year 2 and 3 GSP to be purchased separately (M95541A2)
- GSPMXPPNIM: New GSP or Expired GSP Subscribers, Desktop PC with Maxicom software, based on 3 Years Platinum Plus Global Support Plan, includes month 1 GSP, requires month 2 - 36 GSP to be purchased separately (M95542M2)
- MC2UPG: Maxicom Upgrade Software - CD Only, upgrade existing Maxicom 1.X, 2.X and 3.X system to latest Maxicom Version

Maxicom



## Maxicom<sup>2</sup>® Hardware

### Cluster Control Unit CCU Interface

- Runs real-time operations of a site consisting of up to 28 satellites
- Adapts station sequence to changing conditions for maximum efficiency
- Instantly responds to unexpected conditions and sensor inputs

### ESP-SAT Satellite Controller

- 24, 40 Stations Satellite Controller
- Field Satellite Controller for Maxicom<sup>2</sup> or SiteControl Central Control systems
- The power of an advanced water-management tool, in an easy-to-use package
- All the features and stand-alone capabilities of the Rain Bird ESP-MC Controller line

### ESP-SITE-SAT Satellite Controller

- 24, 40 Stations Satellite Controller
- Combines power of a Cluster Control Unit (CCU) with capabilities of a single ESP-Satellite controller for small Maxicom<sup>2</sup> sites
- Advanced water-management tool, in an easy-to-use package
- All the features and stand-alone capabilities of the Rain Bird ESP-MC Controller line

### Spread Spectrum Radio

- Frequency hopping to avoid interference
- Reduced cost of ownership, no FCC license required
- No FCC restrictions on antenna height (User should check local laws)
- Radios can be set up as repeater to achieve great distances and overcome obstacles

### Ethernet Devices

- Use Ethernet networks to:
  - Communicate from Central Control Computer to CCUs, SiteSats, TWIs and weather stations
  - Communicate from CCU and TWIs to ESP-Sats

### Freedom for Central Control

- Uses standard telephone interface
- Single cellular phone can control entire central control system
- Standard land-line telephones can also control system

### WS-PRO Weather Stations

- Scientific accuracy sensors located three meters above the ground for added vandal-resistance
- Powerful, internal micro-logger for climatic data collection, logging and analysis, constant communication with weather sensors, and storage of 30 days of data
- Rugged yet lightweight metal construction

### Sensor-Pulse Decoders

- Complete feedback system
- Extends central control system versatility
- Color-coded wire leads for ease of installation
- Programmable address codes for individual operation

### RAINGAUGE Rain Sensor

- Accurate rain counter switch counts rainfall in 1/100th inch increments
- Heavy-duty metal construction
- Mounting bracket
- Debris screen

### ANEMOMETER Wind Sensor

- Accurate wind speed measurement for high-wind shutdown or interrupt of irrigation programs
- Heavy-duty metal mounting bracket
- Requires PT322 or PT3002 Pulse Transmitter for use with Maxicom<sup>2</sup> System

### Maxi Interface Boards

- Upgrades an ESP-MC Controller (wall mount or pedestal) to an ESP-SAT or ESP-SITE Satellite Controller
- No additional enclosures or external wiring required
- Installs on stand-offs on controller output board

### MSP-1 Surge Protection

- Protects central control components from electrical surges on a two-wire communication path
- Can be installed in satellite or CCU pedestal or in valve box in conjunction with MGP-1 (Maxicom<sup>2</sup> Grounding Plate)

### MGP-1 Surge Grounding Plate

- Provides a mounting location for MSP-1 or other grounding wires directly to a grounding rod or pipe
- Installed on grounding rod or pipe



CCU-28-W



ESP-40SAT-2W Satellite



MSP-1



MGP-1



RAINGAUGE

## WS-PRO Weather Stations

Maxicom<sup>2</sup>® (WS-PRO2 only), SiteControl, IQ™ v3.0 (WS-PRO2 and WSPROLT)

### Features

- Scientific accuracy sensors located three meters above the ground for added vandal-resistance
- Powerful, internal micro-logger for climatic data collection, logging and analysis, constant communication with weather sensors, and storage of 30 days of data
- Rugged yet lightweight metal construction
- Self-diagnostic test mechanisms: internal moisture, battery voltage level, test port for local sensor check, and simple-to-service sensors and internal components
- State-of-the-art weather software calculates ET values, stores daily and historic ET values, monitors and displays current weather conditions, and graphically displays weather parameters

### SiteControl Features

- WS-PRO2 and WS-PRO-LT Weather Station compatibility is standard for SiteControl v3.0 or later software
- SiteControl can interface with up to 6 weather stations
- Automatic communication between Central Controller and Weather Station requires SiteControl Automatic ET Software Module
- SiteControl Smart Weather Software Module enables automatic, user defined reactions to weather events (rain, freeze, high wind, etc.)



### IQ™ v3.0 Features

- WS- PRO2 or WS-PRO-LT Weather stations are compatible with IQ™ v3.0 or later software with advanced ET Feature Pack (QAETFP)
- Automatic communication between the IQ™ v3.0 central and weather station requires the communication feature pack (IQACOMFP)
- Weather data retrieval hourly or custom retrieval times up to 5 per day
- IQ can interface with 100 weather stations

### Maxicom<sup>2</sup>® Features (WS-PRO2 only)

- WS-PRO2 Weather Station compatibility is standard for Maxicom<sup>2</sup> v3.6 or later software
- Each site can have its own Weather Station or can share between sites
- Automatic communication standard
- Up to 24 automatic weather data retrievals can be configured per day

### Weather Station Sensors

- Air Temperature
- Solar Radiation
- Relative Humidity
- Wind Speed
- Wind Direction
- Rainfall

### System Compatibility

- Maxicom<sup>2</sup> (WS-PRO2 only)
- SiteControl (requires Automatic ET Software Module)
- IQ™ v3.0 with Advanced ET Feature Pack
- ET Manager Weather Reach Server Software

### Models

- WS-PRO2-DC Direct Connect model – 2-pair wire connection with Central Controller via short-haul modem
- WS-PRO2-PH Phone Connect model – dial-up phone modem for phone communication with Central Controller
- WS-PRO2-PHS Phone Connect, Solar Power model – dial-up phone modem for phone communication with Central Controller, solar powered
- WS-PRO-LT-SH Short Haul model – 2-pair wire connection with Central Controller via short-haul modem

## Spread Spectrum Radio

Maxicom<sup>2</sup>®, SiteControl or IQ™

### Features

- Frequency hopping to avoid interference
- Reduced cost of ownership, no FCC license required
- No FCC restrictions on antenna height (User should check local laws)
- Radios can be set up as repeater to achieve great distances and overcome obstacles

### Installation Requirements

- Site Survey required prior to ordering and must be submitted with order
- RADTN9MIB mounts directly onto ESP-SAT MIB; RADTN9TWI connects with ribbon cable
- Antenna and antenna cable required (sold separately by Rain Bird Production and Service Center)

### Models

#### • Radios – For IQ Primary & Secondary Communication and For Maxicom and Site Control Primary Communication

- IQSSRADIO: 900 MHz Spread Spectrum radio – Allows communication between Central Computer and IQ Direct or IQ Server Satellite, and between IQ Server Satellite and IQ Client Satellites. Also can be used for communication between Maxicom Central Computer and CCU or Site Satellite, between Site Control Central Computer and TWI / SDI or LDI, and between a Central Computer and weather station

#### • Radios – For Maxicom and Site Control Secondary Communication

- RADTN9MIB: license free wireless radio (902-928 MHz) between CCU and satellites
- RB-SS-TN9B: Plastic Case Radio – License free radio to communicate to IQ Satellites

## ANEMOMETER Wind Sensor

Maxicom<sup>2</sup>®, SiteControl, IQ™, ESP-LXME, ESP-LXD

### Features

- Accurate wind speed measurement for high-wind shutdown or interrupt of irrigation programs
- Heavy-duty metal mounting bracket
- Requires PT322 or PT3002 Pulse Transmitter for use with Maxicom<sup>2</sup> System
- Requires PT3002 Pulse Transmitter for use with SiteControl, IQ Systems, ESP-LXME, ESP-LXD

### Model

- ANEMOMETER



ANEMOMETER



*"Having grown up in Tucson, saving water is my passion! I became intrigued with 'Drip-in-Turf' after seeing its success at a corporate building in Del Mar, and a College in San Diego. I wanted to experience it myself, so I retro-fitted my own backyard. My turf has an irregular shape, so overspray was a big issue. Applying water directly to the root zone worked efficiently, my turf looks great, and I'm saving water. I am now a true believer and specify 'Drip-in-Turf' whenever I can!"*

**Marian Marum, ASLA, LEED AP**  
Marum Partnership Landscape Architecture  
San Diego, California



## Water Saving Tips

- Drip products deliver water directly to the root zone. Use dripline for dense plantings where it's cost effective to distribute low-volume water evenly. Use a system of precise emitter devices for sparse plantings where it's cost effective to separately irrigate each plant
- Use drip to eliminate overspray, and you'll eliminate waste. Eliminate unsightly spray stains on buildings and fences. Eliminate soil erosion, water runoff, and potential litigation. Walkways, roads, and vehicles stay dry
- Ask your tax advisor about capital depreciation when calculating your return-on-investment for a drip retrofit. Save water, and save money at the same time

### Landscape Drip System Overview

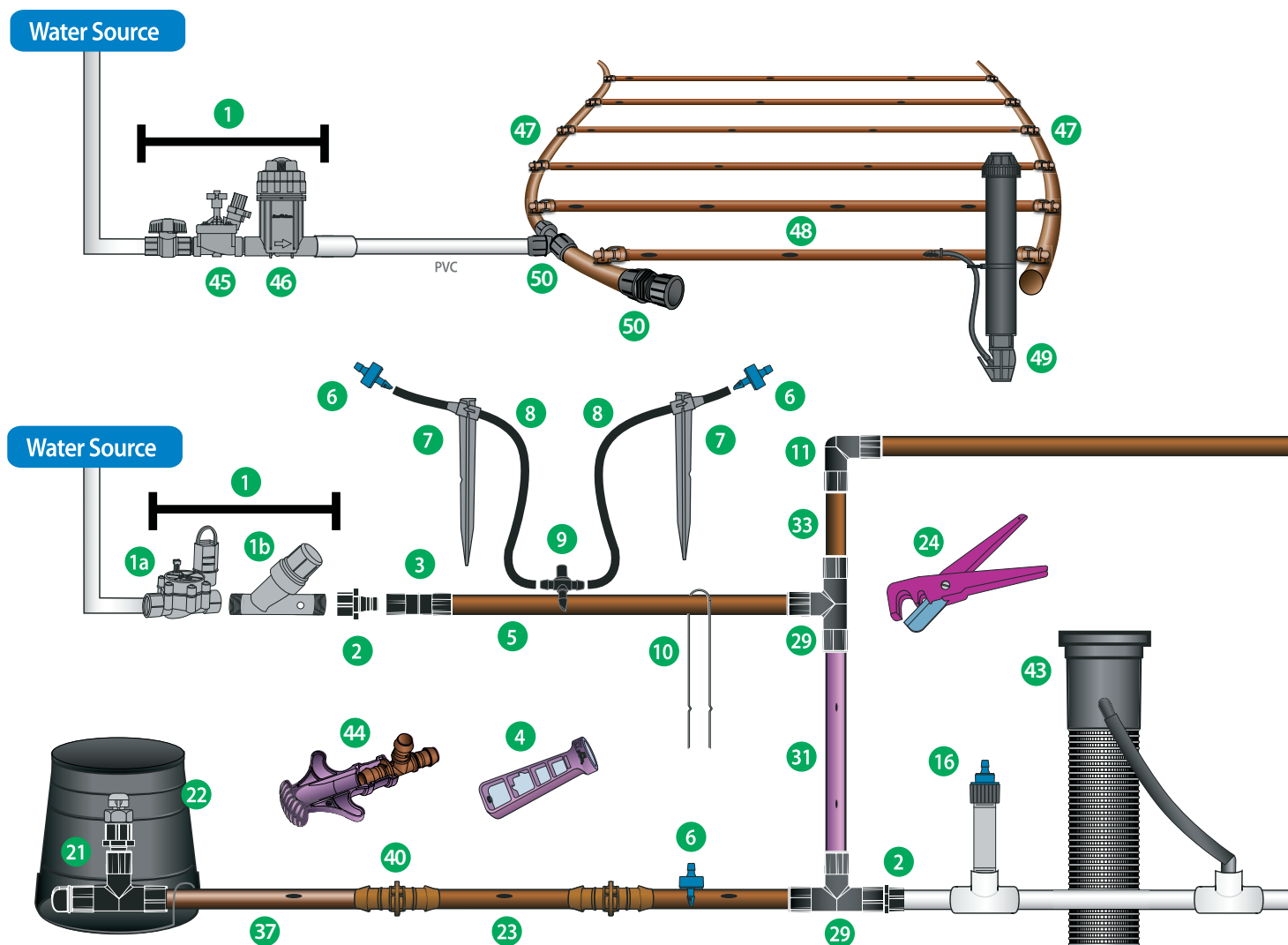
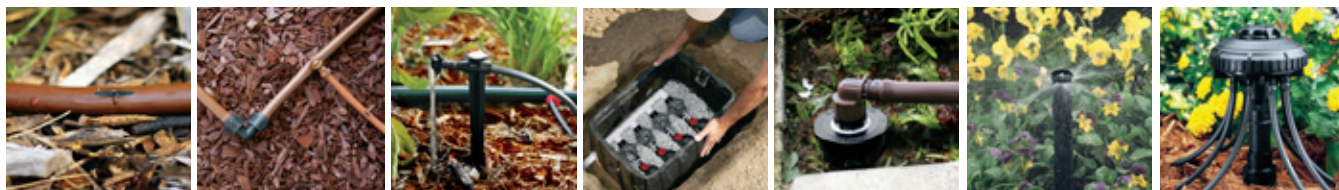

Landscape Drip

- |  |   |   |
|--|---|---|
| 1. Control Zone Kit (pg. 146)            | 8. XQ 1/4" Distribution Tubing (pg. 143)  | 17. 1/4" Self-Piercing Barb Connector (pg. 114) |
| 1a. Low Flow Valve (pg. 153)             | 9. 1/4" Barb Tee (pg. 144)                | 18. SQ Series Square Nozzle (pg. 118)           |
| 1b. Pressure Regulating Filter (pg. 154) | 10. Tie-Down Stake (pg. 144)              | 19. Xeri-Pop (pg. 120)                          |
| 2. Easy Fit Female Adapter (pg. 139)     | 11. Easy Fit Elbow (pg. 139)              | 20. Xeri-Bubbler SPYK (pg. 121)                 |
| 3. Easy Fit Coupling (pg. 139)           | 12. Diffuser Bug Cap (pg. 123)            | 21. ARV050 Air Relief Valve Kit (pg. 140)       |
| 4. Xeriman Tool (pg. 112)                | 13. PC Emitter Diffuser Cap (pg. 123)     | 22. SEB-7X Emitter Valve Box (pg. 144)          |
| 5. XF Series Blank Tubing (pg. 141)      | 14. PC Module-1032 (pg. 116)              | 23. XFD Dripline (pg. 128)                      |
| 6. Xeri-Bug Emitter (pg. 112)            | 15. PolyFlex Riser Assembly (pg. 124)     | 24. Tubing Cutter (pg. 144)                     |
| 7. 1/4" Tubing Stake (pg. 123)           | 16. Xeri-Bug Emitter - 1/2" FPT (pg. 112) | 25. Xeri-Bird 8 (pg. 115)                       |

### Targeted Watering with Landscape Drip

Rain Bird Xerigation®/Landscape Drip products are made especially for low-volume irrigation systems. By delivering water at or near the plants' root zones, Rain Bird Xerigation® products offer targeted watering with the following advantages:

- Water conservation
- Greater efficiency (target each plant)
- Design flexibility; simple construction and easily expandable
- Healthier plants
- Reduced liability (e.g. no overspray, no runoff)
- Minimization of weed growth
- Cost savings

### Broadest Product Line in the Industry

With over 150 products, Rain Bird has the products needed for your application. Systems can be designed to meet any site requirements and offer many exclusive Rain Bird advances including:

- Flexible XF Series dripline with advanced polymers that provide kink-resistance and reduced coil memory for easier installation
- Compact Control Zones with combined pressure regulator and filter to reduce parts, potential leak problems, and allow for fitting more Control Zones in a valve box
- Precision low volume SQ spray nozzles that offer a square wetting pattern and adjust to either 2.5' or 4' throw distances
- Point-source emitters that provide pressure compensation with a wide selection of flow rates and three inlet options (Barb, 1032 threaded, and ½" FPT)
- XFS and XFS-CV dripline with Copper Shield Technology™ for use in sub-surface applications under turf or shrub and groundcover areas. The copper chip effectively protects the emitter from root intrusion

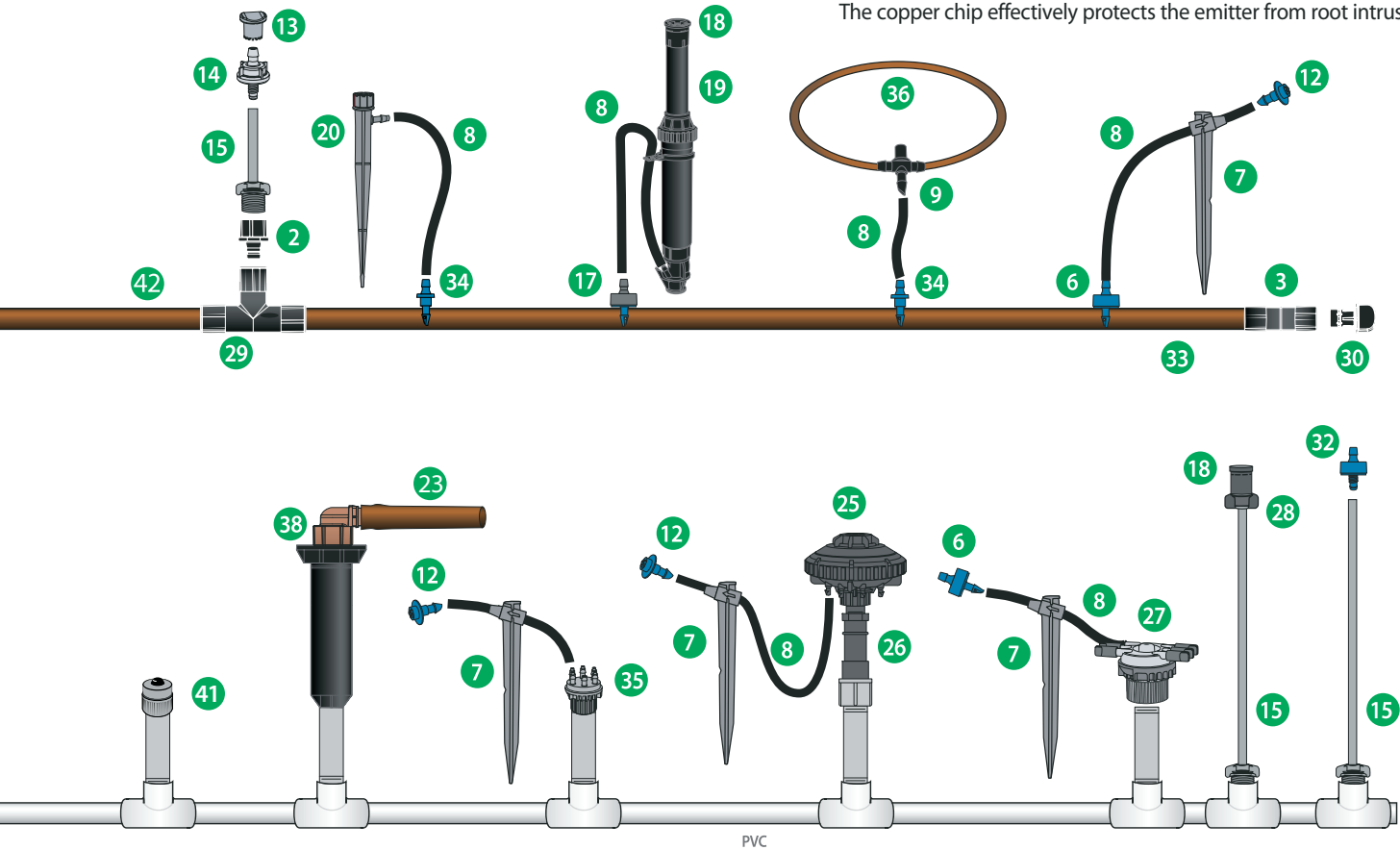

- 26. Inline Pressure Regulator (pg. 155)
- 27. 6 Outlet Manifold (pg. 114)
- 28. SQ Series Nozzle Adapter (pg. 118)
- 29. Easy Fit Tee (pg. 139)
- 30. Easy Fit Flush Cap (pg. 139)
- 31. Purple XF Dripline (pg. 128)
- 32. Xeri-Bug Emitter - 1032 (pg. 112)
- 33. XF Series Blank Tubing (pg. 141)
- 34. ¼" Barb Connector (pg. 144)

- 35. Multi-Outlet Xeri-Bug (pg. 114)
- 36. ¼" Landscape Dripline (pg. 143)
- 37. XFS-CV Sub-Surface Dripline with Copper Shield Technology (pg. 134)
- 38. RETRO-1800 Spray-to-Drip Retrofit Kit (pg. 158)
- 39. XT-025 ½" FPT x Barb Grey Transfer Fitting (pg. 114)
- 40. XFF Coupling (pg. 138)
- 41. PCT Bubbler (pg. 116)

- 42. XFCV Dripline with Heavy-Duty check valve (pg. 130)
- 43. RWS (Root Watering System) (pg. 125)
- 44. XF Insertion Tool (pg. 140)
- 45. PEB Valve (pg. 65)
- 46. Quick-Check Pressure Regulating Filter (pg. 156)
- 47. QF Dripline Header (pg. 136)
- 48. XF Series Dripline (XFD/XFS/XFCV/XFS-CV) (pg. 128-134)
- 49. Operation Indicator (pg. 140)
- 50. Twist Lock Fittings (pg. 137)

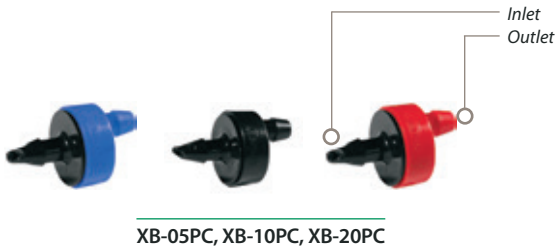

XB-05PC, XB-10PC, XB-20PC

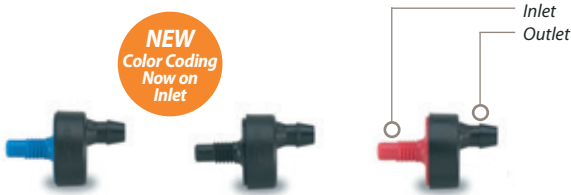

XB-05PC-1032, XB-10PC-1032, XB-20PC-1032

1032-threaded models are specifically designed to be used with PolyFlex Risers, 1032 thread adapters (1032-A), or 1800 Xeri-Bubbler Adapter (XBA-1800)

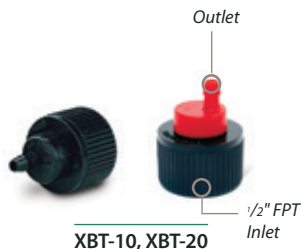

XBT-10, XBT-20

## Xeriman™ Tool

### Features

- Provides fast, easy, one-step installation of Xeri-Bug™ emitters and PC Modules directly into 1/2" or 3/4" drip tubing, XF Dripline or Landscape Dripline
- Cuts emitter installation time
- All-in-one tool inserts emitters, removes emitters, inserts 1/4" barbed fittings and installs goof plugs

### Model

- XM-TOOL



One Step Xeri-Bug™ Insertion



Xeri-Bug™ Removal



Goof Plug Insertion



XM-TOOL

## Xeri-Bug™ Emitters

Point-Source Low-Flow Emitters for Watering the Root Zones of Plants, Trees, and Container Plants

### Features

- The only emitters with self-piercing barbs, making them the easiest to install using the Xeriman™ tool
- Widest selection of pressure-compensating emitters, with 3 flow rates and 3 inlet options
- Most compact and unobtrusive emitters
- Flow-rates of 0.5, 1.0 and 2.0 gph (1.89, 3.79 and 7.57 l/h)
  - Pressure-compensating design delivers uniform flow throughout a wide pressure range (15 to 50 psi; 1.0 to 3.5 bar)
- Available with 3 different inlets (1.0 and 2.0 models):
  - Self-piercing barb for quick, one-step insertion into 1/2" or 3/4" drip tubing
  - 10-32 threaded inlet that easily threads into a PolyFlex Riser (see page 124), 1032 Thread adapter (page 124) or 1800 Xeri-Bubbler Adapter (page 124)
  - 1/2" FPT inlet that easily threads onto a 1/2" PVC riser (1.0 and 2.0 gph models)
- Outlet barb securely retains 1/4" Distribution Tubing (XQ)
- Design makes installation and maintenance easy
  - Self-flushing action minimizes clogging
  - Robust design made from highly inert materials that are resistant to chemicals
  - Durable plastic construction is UV-resistant
- Color-coded to identify flow rate

### Operating Range

- Flow: 0.5 to 2.0 gph (1.89 to 7.57 l/h)
- Pressure: 15 to 50 psi (1.0 to 3.5 bar)
- Required filtration: 150 to 200 mesh (75 to 100 micron)

### Models: barb inlet x barb outlet

- XB-05PC: Blue, 0.5 gph (1.89 l/h)
- XB-10PC: Black, 1.0 gph (3.79 l/h)
- XB-20PC: Red, 2.0 gph (7.57 l/h)

### Models: 10-32 thread inlet x barb outlet

- XB-05PC-1032: Blue, 0.5 gph (1.89 l/h)
- XB-10PC-1032: Black, 1.0 gph (3.79 l/h)
- XB-20PC-1032: Red, 2.0 gph (7.57 l/h)

### Models: 1/2" FPT inlet x barb outlet

- XBT-10: Black, 1.0 gph (3.79 l/h)
- XBT-20: Red, 2.0 gph (7.57 l/h)

### How To Specify

XB - T - 05 - PC - 1032

Optional  
1032 threaded  
inlet

Pressure Compensating

Flow  
05 = 0.5 gph (1.89 l/h)  
10 = 1.0 gph (3.79 l/h)  
20 = 2.0 gph (7.57 l/h)

Optional  
1/2" FPT inlet

Model  
Xeri-Bug



Xeri-Bug Emitter Specifications and Models			
Model	Inlet Type/ Color	Nominal Flow gph	Filtration Required mesh
XB-05PC	Barb/Blue	0.5	200
XB-10PC	Barb/Black	1.0	150
XB-20PC	Barb/Red	2.0	150
XB-05PC1032	10-32T/Blue	0.5	200
XB-10PC1032	10-32T/Black	1.0	150
XB-20PC1032	10-32T/Red	2.0	150
XBT-10PC	½" FPT/Black	1.0	150
XBT-20PC	½" FPT/Black	2.0	150

Xeri-Bug Emitter Specifications and Models			METRIC
Model	Inlet Type/ Color	Nominal Flow l/h	Filtration Required micron
XB-05PC	Barb/Blue	1.89	75
XB-10PC	Barb/Black	3.79	100
XB-20PC	Barb/Red	7.57	100
XB-05PC1032	10-32T/Blue	1.89	75
XB-10PC1032	10-32T/Black	3.79	100
XB-20PC1032	10-32T/Red	7.57	100
XBT-10PC	½" FPT/Black	3.79	100
XBT-20PC	½" FPT/Black	7.57	100



Xeri-Bug™ Emitter, TS025-1/4" stake, and DBC025 Diffuser Bug Cap

### Xeri-Bug Emitter Performance

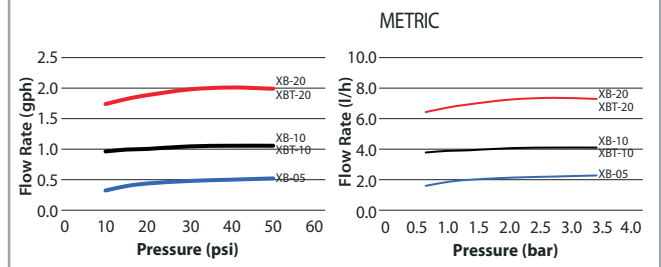

(For reference numbers below, please see the System Overview page 110)

#### Installation Option 1\*

Using a Xeriman Tool, insert an emitter directly into ½" or ¾" drip tubing or between dripline emitters as needed.



#### Installation Option 2\*

For more precise water placement, use ¼" distribution tubing, a ¼" tubing stake, and a bug cap.

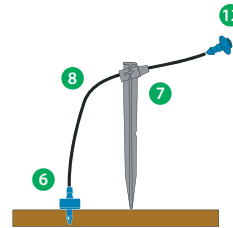

#### Installation Option 3

For precise water placement, a barbed connector can be punched into distribution tubing. The emitter is then placed at the end of the ¼" distribution tubing. NOTE: should the emitter become dislodged, unregulated flow will occur.

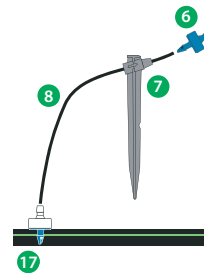

#### Installation Option 4\*

The Xeri-Bird 8 provides a centralized location for up to eight emitters. A mix of Xeri-Bug and/ or PC emitters can be used to provide the flow rates needed for different plant materials. Tentacles of ¼" distribution tubing, ¼" tubing stakes, and bug caps allow for precise water placement.

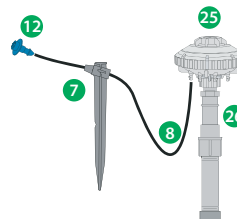

#### Installation Option 5

The 6 Outlet Manifold provides a centralized water distribution connection for up to six emission devices. Connect the ¼" distribution tubing to one of the outlets. Use a ¼" tubing stake to ensure precise water placement. The emitter is placed on the end of the ¼" distribution tubing to regulate the water flow. NOTE: should the emitter become dislodged, unregulated flow will occur.

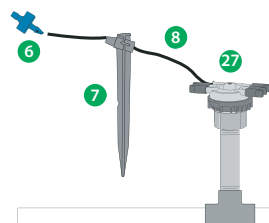

\* Preferred installation options, which provide flow regulation at the source.

## Multi-Outlet Xeri-Bug™

### Features

- Pressure compensating design delivers uniform flow throughout a wide pressure range (15 to 50 psi; 1.0 to 3.5 bar)
- Six-outlet emitter supplied with one outlet opened. Simply clip the outlet tips open with snips or clippers for additional operational ports
- Barbed outlets retain ¼" Distribution Tubing (XQ)
- Self-flushing action minimizes clogging
- Durable, UV-resistant color-coded plastic housing

### Operating Range

- Flow: 0.5, 1.0 or 2.0 gph (1.89, 3.79 or 7.57 l/h)
- Pressure: 15 to 50 psi (1.0 to 3.5 bar)
- Filtration: 150-mesh (100-microns)

### Models: barb inlet x barb outlet

- XB-05-6: Blue, 0.5 gph (1.89 l/h)
- XB-10-6: Black, 1.0 gph (3.79 l/h)
- XB-20-6: Red, 2.0 gph (7.57 l/h)

### Models: ½" FPT inlet x barb outlet

- XBT-05-6: Blue, 0.5 gph (1.89 l/h)
- XBT-10-6: Black, 1.0 gph (3.79 l/h)
- XBT-20-6: Red, 2.0 gph (7.57 l/h)



XB-05-6, XB-10-6, XB-20-6



XBT-05-6, XBT-10-6, XBT-20-6

### Multi-Outlet Xeri-Bug Emitter Performance

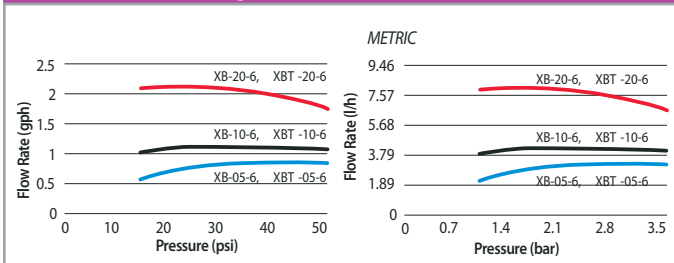

## 6 Outlet Manifold - EMT-6XERI

### Features

- ½" FPT inlet threads onto ½" riser and provides a manifold with six free-flowing ¼" barb outlets
- Each barb outlet is sealed with a durable plastic cap
- Plastic caps remove easily, allowing for a drip area that can be customized with up to six different emission devices
- Attach ¼" Distribution Tubing (XQ) onto each outlet for use with: Xeri-Bugs, PC Modules, Xeri-Pops, Xeri-Sprays, and Xeri-Bubblers

### Operating Range

- Pressure: 15 to 50 psi (1.0 to 3.5 bar)

### Model

- EMT-6XERI



EMT-6XERI

## ¼" Self-Piercing Barb Connector

### Features

- Used to connect ¼" Distribution Tubing into ½" or ¾" distribution tubing
- Self-piercing barb inlet is easily inserted into ½" or ¾" distribution tubing using a Xeriman™ Tool (XM-Tool)
- Outlet barb accepts ¼" Distribution Tubing (XQ). Gray outlet barb indicates unit has unrestricted flow

### Operating Range

- Pressure: 0 to 50 psi (0 to 3.5 bar)

### Model

- SPB-025

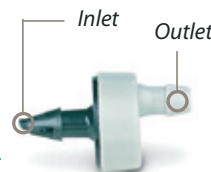

SPB-025

## ½" FPT x Barb Grey Transfer Fitting

### Features

- Grey outlet to designate open flow
- ½" FPT inlet can be easily attached to a schedule 80 riser or the top of an 1800 Retro
- Barbed outlet so ¼" distribution tubing or ¼" drip tubing can be easily and securely attached

### Operating Range

- Pressure: 0 to 50 psi (0 to 3.5 bar)

### Model

- XT025



XT025

## Xeri-Bird™ 8-Outlet Emission Device

The Most Flexible and Feature-Rich Multi-Outlet Device on the Market, Ideal for New Projects and Retrofit Applications

### Features

- The only multi-outlet device on the market with 8 configurable ports and 10 flow options for each port for maximum flexibility
- XBD-80 and XBD-81 models each contain a built-in filter. Makes retro-fitting easy when installed with the optional in-stem pressure regulator (PRS-050 page 155)
- Easy to maintain, because body can be easily removed from riser
- Threads onto any 1/2" riser and delivers water to multiple locations for increased system flexibility
- Each port accepts a Xeri-Bug™ Emitter or PC Module for independent flows from 0.5 to 24 gph (1.89 to 90.84 l/h) or use a self-piercing barb connector (SPB-025) for unrestricted flow
- XBD-80 and XBD-81 models each feature an integral 200 mesh (75 micron) filter which is easily serviceable from the top of the unit
- Eight bottom-mounted, sure-grip barbed outlets securely retain 1/4" Distribution Tubing (XQ)
- Unique union base nut allows removal of Xeri-Bird 8 body from riser for easy installation and maintenance
- Emitters must be installed inside the Xeri-Bird to prevent excess back pressure

### Operating Range

- Flow: 0 to 24 gph (0 to 90.84 l/h) per outlet
- Pressure: 15 to 50 psi (1.0 to 3.5 bar)

### Models

- XBD-80: Xeri-Bird 8 unit (includes 7 removable port plugs and filter)
- XBD-81: Xeri-Bird 8 unit (includes eight 1 gph (3.79 l/h) Xeri-Bug emitters factory installed, and filter)

### Replacement Parts:

- XBD8SCRN: replacement screen and two o-rings



Each port can be configured on the Xeri-Bird™ by installing flow controlled emitters. Above shows a combination of 0.5, 1.0, and 2.0 gph Xeri-Bug emitters.



**Helpful Hint:** Always install emitters with the pointed end (inlet barb) or threaded end up, as shown

\* Must be installed second  
\*\*Must be installed first



PC-05, PC-07, PC-10



PC-12, PC-18, PC-24



PC-05-1032, PC-07-1032, PC-10-1032

10-32-threaded models are specifically designed to be used with PolyFlex Risers, 10-32 thread adapters (1032-A), or 1800 Xeri-Bubbler Adapter (XBA-1800)



PCT-05, PCT-07, PCT-10

1/2" FPT inlet that easily threads onto a 1/2" PVC riser

## Pressure-Compensating Modules

Point-Source Medium-Flow Emitters for Watering Larger Shrubs and Trees

### Features

- The only emitters with self-piercing barbs, making them the easiest to install using the Xeriman™ tool
- Widest selection of pressure-compensating emitters, with 6 flow rates and 3 inlet options
- Most compact and unobtrusive emitters
- Flow rates from 5 to 24 gph (18.93 to 90.84 l/h)
- Pressure-compensating design delivers uniform flow throughout a wide pressure range (10 to 50 psi; 0.7 to 3.5 bar)
- Available with 3 different inlets:
  - Self-piercing barbs for quick one-step emitter insertion into 1/2" or 3/4" drip tubing
  - 10-32 threaded inlet that easily threads into a PolyFlex Riser (see page 124), 1032 Thread adapter (page 124) or 1800 Xeri-Bubbler Adapter (page 124)
  - 1/2" FPT inlet that easily threads onto a 1/2" PVC riser
- Robust design - durable plastic construction is UV-resistant and color-coded to identify flow rate

### Operating Range\*

- Flow: 5 to 24 gph (18.93 to 90.84 l/h)
- Pressure: 10 to 50 psi (0.7 to 3.5 bar)
- Required filtration: 100 mesh (150 micron)

\* **IMPORTANT NOTE:** Use a PC Diffuser Cap to eliminate squirting water when using a PC Module staked at the end of 1/4" Distribution Tubing (XQ) or on a PolyFlex Riser (PFR/FRA)

### Models: barb inlet x barb outlet

- PC-05: Light brown, 5 gph (18.93 l/h)
- PC-07: Violet, 7 gph (26.50 l/h)
- PC-10: Green, 10 gph (37.85 l/h)
- PC-12: Dark brown, 12 gph (45.42 l/h)
- PC-18: White, 18 gph (68.13 l/h)
- PC-24: Orange, 24 gph (90.84 l/h)

### Models: 10-32 thread inlet x barb outlet

- PC-05-1032: Light brown, 5 gph (18.93 l/h)
- PC-07-1032: Violet, 7 gph (26.50 l/h)
- PC-10-1032: Green, 10 gph (37.85 l/h)

### Models: 1/2" FPT thread Inlet

- PCT-05: Light Brown, 5 gph (18.93 l/h)
- PCT-07: Violet, 7 gph (26.50 l/h)
- PCT-10: Green, 10 gph (37.85 l/h)

### How To Specify

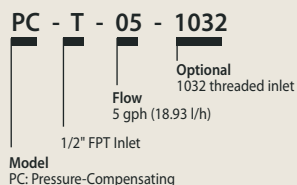

## Pressure-Compensating Modules

Pressure-Compensating Module Models			
Model	Inlet Type/ Outlet/Color	Nominal Flow gph	Filtration Required mesh
PC-05	Barb / light brown	5	100
PC-07	Barb / violet	7	100
PC-10	Barb / green	10	100
PC-12	Barb / dark brown	12	100
PC-18	Barb / white	18	100
PC-24	Barb / orange	24	100
PC-05-1032	10-32T / light brown	5	100
PC-07-1032	10-32T / violet	7	100
PC-10-1032	10-32T / green	10	100
PCT-05	NPT / light brown	5	100
PCT-07	NPT / violet	7	100
PCT-10	NPT / green	10	100

Pressure-Compensating Module Models   METRIC			
Model	Inlet Type/ Outlet/Color	Nominal Flow l/h	Filtration Required micron
PC-05	Barb / light brown	18.93	150
PC-07	Barb / violet	26.50	150
PC-10	Barb / green	37.85	150
PC-12	Barb / dark brown	45.42	150
PC-18	Barb / white	68.13	150
PC-24	Barb / orange	90.84	150
PC-05-1032	10-32T / light brown	18.93	150
PC-07-1032	10-32T / violet	26.50	150
PC-10-1032	10-32T / green	37.85	150
PCT-05	NPT / light brown	18.93	150
PCT-07	NPT / violet	26.50	150
PCT-10	NPT / green	37.85	150

## Pressure-Compensating Modules & Bubblers Performance

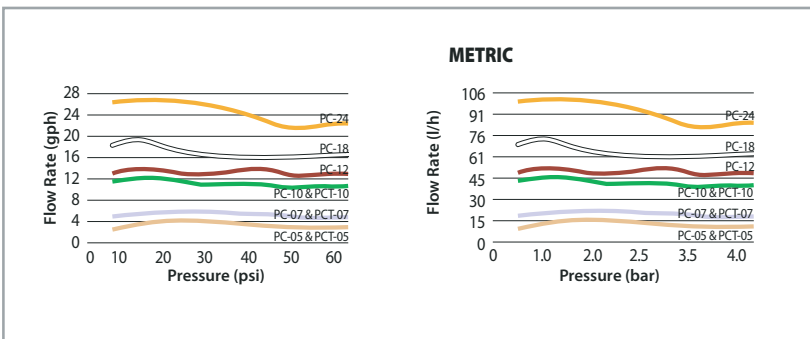

## PC Diffuser Caps



PC Diffuser Caps are designed to fit onto outlet of pressure-compensating drip modules

**Models:** (see page 123 for complete information)

- PC-DIFFUSER: Black
- PC-DIFF-PPL: Purple, to designate non-potable water



PC Module (PC-10-1032) with PC Diffuser Cap (PC-DIFFUSER) on PolyFlex Riser (PFR-PFA) (PolyFlex Risers available in 12" and 24" models - p. 124)



SQ Nozzle Installed on PolyFlex Riser with Nozzle Adapter



SQ Nozzles with Screens

### One Nozzle...Two Throws

With a simple turn of the nozzle to the next preset stop, the Rain Bird SQ Nozzle adjusts from a 2.5' (0.8 m) throw to a 4' (1.2 m) throw. It's like having two nozzles in one.



### Can be used on...

The SQ Nozzle is an ideal solution for a wide range of difficult-to-design areas, thanks to its compatibility with popular irrigation products.

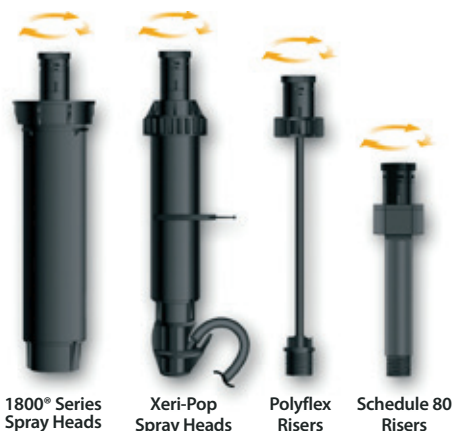

1800® Series Spray Heads

Xeri-Pop Spray Heads

Polyflex Risers

Schedule 80 Risers

## SQ Series, Square Pattern Nozzles

The Most Precise and Efficient, Low-Volume Spray Solution for Irrigation of Small Areas with Dense Plantings

### Features

- Square spray pattern and pressure compensation offer increased efficiency and control, reducing overspray, property damage and liability
- Simplify design and installation with the flexibility of applications: one nozzle throws 2.5' or 4' (0.8 m or 1.2 m) and can be used on a variety of spray heads and risers
- Meets micro irrigation system requirement for less than 26 gph flow rate at 30 psi
- Square spray pattern with edge-to-edge coverage allows you to easily design and install in small spaces
- Pressure compensation design delivers uniform flow over the pressure range
- Available in 3 models—quarter, half and full patterns with matched precipitation rate
  - Virtually no-mist performance from 20 psi to 50 psi
  - Two throw distances in each nozzle. One simple click adjusts to 2.5' or 4' (0.8 m or 1.2 m)
  - Shipped with blue filter screen (0.02" x 0.02") to maintain precise distance of flow, and to prevent clogging
- Compatible with all 1800 Sprays, Xeri-Pops, New PolyFlex Riser Adapter, UNI-Spray and SCH 80 risers

### Operating Range

- Pressure: 20 to 50 psi (1.4 to 3.5 bar)
- Flow rates: 6, 12 and 24 gph (22.7, 45.4 and 90.8 l/h)
- Required filtration: 40 mesh

### Models

- SQ-QTR: SQ Nozzle, quarter pattern (Purple)
- SQ-HLF: SQ Nozzle, half pattern (Brown)
- SQ-FUL: SQ Nozzle, full pattern (Red)
- SQ-ADP: SQ PolyFlex Riser Adapter only
- SQ-ADP12: SQ Nozzle Adapter with 12" PolyFlex Riser
- SQ-ADP24: SQ Nozzle Adapter with 24" PolyFlex Riser



\* **Note:** A PA-8S Plastic Shrub Adapter (see page 10) is needed when using an SQ Series Nozzle mounted on a SCH 80 riser.









SQ-QTR



SQ-HLF

SQ-FUL









SQ Nozzle Performance					
2.5 feet throw @ 6" height above grade					
Nozzle	Pressure psi	Throw Radius ft.	Flow gph	Flow gpm	Precip. Rate w/no overlap in/h
<b>Q</b> 	20	2.5	6.0	0.10	1.64
	30	2.5	7.0	0.12	1.90
	40	3.0	7.2	0.12	1.32
	50	3.0	7.2	0.12	1.32
<b>H</b> 	20	2.5	10.2	0.17	1.31
	30	2.5	10.7	0.18	1.57
	40	3.0	10.7	0.18	1.22
	50	3.0	10.7	0.18	1.22
<b>F</b> 	20	2.5	20.0	0.33	1.28
	30	2.5	24.2	0.40	1.55
	40	3.0	27.3	0.46	1.22
	50	3.0	27.3	0.46	1.22

SQ Nozzle Performance					METRIC
0.8 m throw @ 0.15 m height above grade					
Nozzle	Pressure bar	Throw Radius m.	Flow lph	Flow lpm	Precip. Rate w/no overlap mm/h
<b>Q</b> 	1.4	0.8	23	0.38	42
	2.1	0.8	27	0.44	48
	2.8	0.9	27	0.45	34
	3.4	0.9	27	0.45	34
<b>H</b> 	1.4	0.8	39	0.65	33
	2.1	0.8	41	0.68	40
	2.8	0.9	41	0.68	31
	3.4	0.9	41	0.68	31
<b>F</b> 	1.4	0.8	76	1.27	33
	2.1	0.8	92	1.53	39
	2.8	0.9	103	1.72	31
	3.4	0.9	103	1.72	31

SQ Nozzle Performance					
4 feet throw @ 6" height above grade					
Nozzle	Pressure psi	Throw Radius ft.	Flow gph	Flow gpm	Precip. Rate w/no overlap in/h
<b>Q</b> 	20	4.0	6.0	0.10	0.64
	30	4.0	7.2	0.12	0.74
	40	4.5	7.2	0.12	0.59
	50	4.5	7.2	0.12	0.59
<b>H</b> 	20	4.0	10.2	0.17	0.51
	30	4.0	10.7	0.18	0.61
	40	4.5	10.7	0.18	0.54
	50	4.5	10.7	0.18	0.54
<b>F</b> 	20	4.0	20.0	0.33	0.50
	30	4.0	24.2	0.40	0.61
	40	4.5	27.3	0.46	0.54
	50	4.5	27.3	0.46	0.54

SQ Nozzle Performance					METRIC
1.2 m throw @ 0.15 m height above grade					
Nozzle	Pressure bar	Throw Radius m.	Flow lph	Flow lpm	Precip. Rate w/no overlap mm/h
<b>Q</b> 	1.4	1.2	23	0.38	16
	2.1	1.2	27	0.44	19
	2.8	1.4	27	0.45	15
	3.4	1.4	27	0.45	15
<b>H</b> 	1.4	1.2	39	0.65	13
	2.1	1.2	41	0.68	16
	2.8	1.4	41	0.68	14
	3.4	1.4	41	0.68	14
<b>F</b> 	1.4	1.2	76	1.27	13
	2.1	1.2	92	1.53	15
	2.8	1.4	103	1.72	14
	3.4	1.4	103	1.72	14

Performance data taken in zero wind conditions

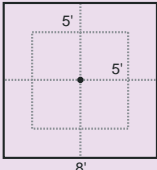
SQ Nozzles	Quarter Model	Half Model	Full Model
			
			
			

## Xeri-Pop™ Micro-Spray

The Xeri-Pop™ Micro-Spray Makes It Easy to Integrate a Durable Micro-Spray into a Low-Volume Irrigation Design

### Features

- The only pop-up spray that works in low-volume low-pressure application, and this is the perfect solution to vandal-prone areas
- Xeri-Pops can be installed and located in nearly any location and are ideal for small, odd-shaped planting beds; the 12" version is perfect for annual flower beds
- Xeri-Pops work with Rain Bird 5' and 8' MPR nozzles and SQ Series Nozzles — nozzles with square spray patterns and adjustable throws of 2.5' and 4'
- The Xeri-Pop can operate with 20 to 50 psi base pressure when water is supplied via ¼" Distribution Tubing (XQ)
- The flexibility of ¼" tubing allows the Xeri-Pop to be easily located and relocated as planting conditions dictate
- A durable, plastic snap-collar (on 4" and 6" models) secures the ¼" tubing to the outside of the Xeri-Pop case
- The Xeri-Pop's ¼" Distribution Tubing can readily connect to ½" or ¾" polyethylene tubing or to a multi-outlet manifold (EMT-6XERI). Connections to polyethylene tubing are accomplished with either an SPB-025 ¼" Self-piercing barb Connector or an XBF1CONN ¼" barb Connector
- External parts are UV-resistant and available in 4", 6" and 12" pop up heights

### Operating Range

- Pressure: 20 to 50 psi (1.4 to 3.5 bar)
- Filtration: Depends on nozzle used with Xeri-Pop

### Models

- XP-400X: 4-inch pop-up
- XP-600X: 6-inch pop-up
- XP-1200X: 12-inch pop-up

### Nozzle Options

- SQ Series Nozzles (page 118)
- 5 Series MPR Nozzle (all configurations)
- 5 Series Plastic Bubbler
- 8 Series MPR Nozzle (8H, 8T and 8Q)

### Installing the Xeri-Pop in 4 Easy Steps

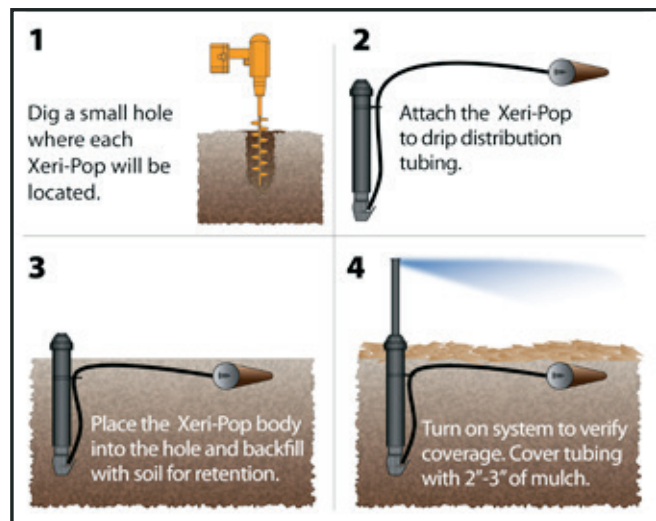

### How To Specify

#### XP - 600X

Model  
Xeri-Pop

Pop-Up Height  
400X = 4" Pop-up  
600X = 6" Pop-up  
1200X = 12" Pop-up

Always install a PCS-010, -020, 030, or -040 Pressure-Compensating Screen whenever a 5B Bubbler Nozzle is installed on a Xeri-Pop.

XP-400X



XP-600X

¼" distribution tube snap collar

¼" distribution tube inlet



XP-1200X





## Xeri-Bubblers™

Ideal for Shrub Plantings, Trees, Containers, and Flower Beds

### Features

- Adjust flow and radius by turning outer cap
- Clean by completely unscrewing cap from base unit
- Three convenient installation connections available for design flexibility: 10-32 self-tapping thread, 1/4" barb, and 5" spike

### Operating Range

- Pressure: 15 to 30 psi (1.0 to 2.1 bar)
- SXB Series flow:
  - 0 to 13 gph (0 to 49.21 l/h) at 30 psi (2.1 bar)
  - 0 to 8.5 gph (0 to 30 l/h) at 15 psi (1 bar)
- UXB Series flow:
  - 0 to 35 gph (0 to 132.48 l/h) at 30 psi (2.1 bar)
  - 0 to 26 gph (0 to 98 l/h) at 15 psi (1 bar)
- Max flow varies with inlet pressure

### Models

- SXB-180: Half-circle, 5 streams, 10-32 thread
- SXB-180-025: Half-circle, 5 streams, 1/4" barb
- SXB-180-SPYK: Half-circle, 5 streams, 5" spike; includes barb x barb coupler
- SXB-360: Full-circle, 8 streams, 10-32 thread
- SXB-360-025: Full-circle, 8 streams, 1/4" barb
- SXB-360-SPYK: Full-circle, 8 streams, 5" spike includes barb x barb coupler
- UXB-360: Full-circle, umbrella, 10-32 thread
- UXB-360-025: Full-circle, umbrella, 1/4" barb
- UXB-360-SPYK: Full-circle, umbrella, 5" spike includes barb x barb coupler

### How To Specify

#### SXB - 180 - 025

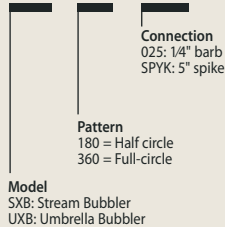

### WETTING PATTERNS

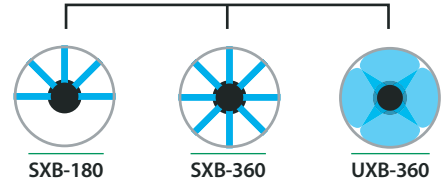

### BARB

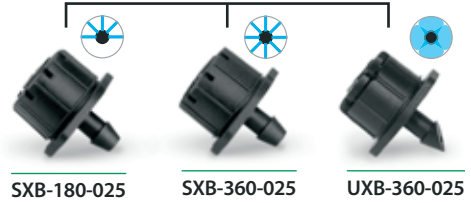

### 10-32 THREADS

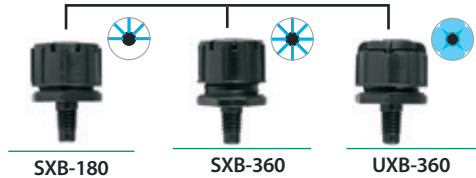

### SPIKE



### Xeri-Bubbler Performance

Pressure		SXB Flow Rate 360° and 180°		SXB 360° Diameter		SXB 180° Radius		UXB 360° Flow Rate		UXB 360° Diameter	
psi	bar	gph	lph	ft.	m.	ft.	m.	gph	lph	ft.	m.
30	2.1	0 - 13	0 - 49	0 - 3	0 - 0.9	0 - 2.2	0 - 0.67	0 - 35	0 - 132	0 - 2	0 - 0.58
20	1.4	0 - 10.5	0 - 40	0 - 2	0 - 0.6	0 - 1.5	0 - 0.46	0 - 30	0 - 113	0 - 1	0 - 0.30
15	1	0 - 8.5	0 - 32	0 - 1.2	0 - 0.4	0 - 1.2	0 - 0.38	0 - 27	0 - 98	0 - 0.7	0 - 0.21

## Xeri-Sprays™ and Misters

Ideal for Ground Cover, Mass Plantings, Annual Flower Beds, and Containers

### Features

- Adjust flow/radius by turning integral ball valve
- Uniform emission pattern provides excellent distribution
- 10-32 self-tapping threads fit into ½" x 10-32 adapter (10-32A); 1800 Xeri-Bubbler™ adapter (XBA-1800); and PolyFlex Riser (PFR-12)

### Operating Range

- Flow: 0 to 31 gph (0 to 117.34 l/h)
- Pressure: 10 to 30 psi (0.75 to 2.1 bar)
- Radius: 0 to 13.4 feet (0 to 4.1 m) full-circle; 0 to 10.6 feet (0 to 3.2 m) quarter- and half-circle

### Models

- XS-090: Quarter-circle, spray
- XS-180: Half-circle, spray
- XS-360: Full-circle, stream spray
- X360 ADJMST: Full-circle, mist

## Xeri-Spray™ 360° True Spray

Ideal for Mass Plantings, Ground Cover, Annual Flower Beds and Containers

### Features

- True micro-spray with full-circle fan spray pattern
- Adjust flow/radius by turning outer cap
- Three convenient installation connections for design flexibility: 10-32 self-tapping thread, ¼" barb and 5" spike
- Easily cleaned by completely unscrewing cap from base unit

### Operating Range

- Flow: 0 to 24.5 gph (0 to 92.7 l/h) at 30 psi (200 kPa)
- Flow: 0 to 17 gph (0 to 64 l/h) at 15 psi (100 kPa)
- Pressure: 15 to 30 psi (1.0 to 2.1 bar)
- Radius: 0 to 6.7 feet (0 to 2.0 m)

### Models

- XS-360TS: 10-32 threads
- XS-360TS-025: ¼" barb
- XS-360TS-SPYK: 5" spike; includes barb x barb coupler

### WETTING PATTERNS

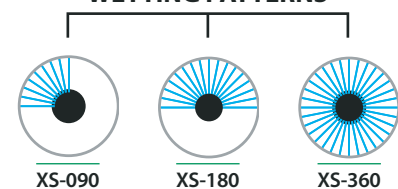

XS-090

XS-180

XS-360



XS-090

XS-180

XS-360

X360 ADJMST

### WETTING PATTERN



XS-360TS



XS-360TS-025

XS-360TS

XS-360TS-SPYK

## Xeri-Sprays™ and Misters Performance

Pressure		Flow		XS-90 Radius of throw		XS-180 Radius of throw		XS-360 Radius of throw		360 Mister Radius of throw	
psi	bar	gph	l/h	ft.	m.	ft.	m.	ft.	m.	ft.	m.
10	0.7	0-16.7	0-63.21	0-6.4	0-2.0	0-6.7	0-2.0	0-9.2	0-2.8	0-1.5	0-0.46
15	1.0	0-21.0	0-79.49	0-8.1	0-2.5	0-8.1	0-2.5	0-11.3	0-3.4	0-1.3	0-0.40
20	1.4	0-24.5	0-92.73	0-9.4	0-2.9	0-9.5	0-2.9	0-12.9	0-3.9	0-1.5	0-0.44
25	1.7	0-28.0	0-105.98	0-9.8	0-3.0	0-10.1	0-3.1	0-13.2	0-4.0	0-1.4	0-0.43
30	2.1	0-31.0	0-117.34	0-10.3	0-3.1	0-10.6	0-3.2	0-13.4	0-4.1	0-1.3	0-0.40

## Diffuser Bug Cap

### Features

- Prevents bugs and other debris from clogging 1/4" Distribution Tubing
- Barbed inlet fits into 1/4" Distribution Tubing (XQ)
- Flanged shield diffuses water to minimize soil erosion at emission point

### Operating Range

- Pressure: 0 to 50 psi (0 to 3.5 bar)

### Models

- DBC-025: Black

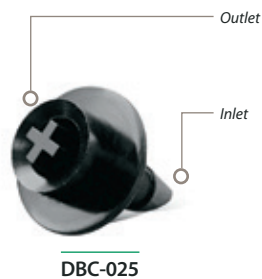

DBC-025

## PC Diffuser Cap

### Features

- Cap snaps securely onto the PC Module and XB emitter outlet to create bubbler effect and prevent wash out
- Designed for quick and easy installation
- Made of UV-resistant polyethylene material

### Models

- PC-DIFFUSER: Black
- PC-DIFF-PPL: Purple to designate non-potable water



PC-DIFFUSER

PC-DIFF-PPL

## Suggested Applications



A. 1/4" tubing, 1/4" stake, PC Module, Diffuser Bug Cap.  
Used for runs greater than 5 feet from main line

B. 1/4" tubing, 1/4" stake, Diffuser Bug Cap.  
Used for runs up to 5 feet from main line

(Drip emitter not shown – installed directly into lateral line)

## Universal 1/4" Tubing Stake

### Features

- Holds 1/4" Distribution Tubing and emitter or Diffuser Bug Cap firmly in place at the root zone of the plant
- Designed to securely hold Rain Bird and other manufacturers' 1/4" Distribution Tubing — 0.16" to 0.18" I.D. and 0.22" to 0.25" O.D.
- Rigid stake featuring a flat enlarged head designed to withstand hammering into tough soil

*Note: If emitter is installed at inlet to distribution tubing, use a Diffuser Bug Cap (DBC-025) at outlet of tubing to prevent bugs from clogging tubing and to help hold tubing in place*

### Model

- TS-025



TS-025

## 1/4" Tubing Stake with Cap

### Features

- Locking cap holds tubing in place
- Used for holding 1/4" Distribution Tubing (XQ) in place at the plant root zone
- Accepts 1/4" Distribution Tubing from 0.19 O.D. to 0.256 O.D.
- Bug cap included
- Constructed of UV-resistant plastic material

### Model

- TS-025WCAP



TS-025WCAP

## 12" PolyFlex Riser

### Features

- 12" riser that is used with any 10-32 threaded emission device to deliver water directly to a plant. These include Xeri-Bugs, PC Modules, Xeri-Bubblers and Xeri-Sprays
- Extremely rugged and reliable – constructed of thick-walled, high-density polyethylene
- Can be used with a riser-stake (RS-025T)

### Operating Range

- Pressure: 15 to 50 psi (1.0 to 3.5 bar)

### Model

- PFR-12

PFR-12



## PolyFlex Riser and Adapter Assemblies

### Features

- 12" or 24" riser that is pre-assembled with a 1/2" male threaded base that simplifies installation
- Use with any 10-32 threaded emission device to deliver water directly to a plant. These include Xeri-Bugs, PC Modules, Xeri-Bubblers and Xeri-Sprays
- Newly-designed adapter with larger tabs makes installation quicker and easier; can be used on PVC laterals, or with any 1/2" female threaded adapter
- Adapter made of heavy-duty Marlex®, which requires no Teflon® tape, saving time during installation
- Extremely rugged and reliable PolyFlex Riser constructed of thick-walled, high-density polyethylene

### Operating Range

- Pressure: 15 to 50 psi (1.0 to 3.5 bar)

### Models

- PFR-FRA: 12" (30.5 cm) PolyFlex Riser and adapter
- PFR-FRA24: 24" (61.0 cm) PolyFlex Riser and adapter

PFR-FRA



## PolyFlex Riser and Stake Assembly

### Features

- 12" riser that is pre-assembled with a 7" (30.5 cm) stake
- Use with any 10-32 threaded emission device to deliver water directly to a plant. These include Xeri-Bugs, PC Modules, Xeri-Bubblers and Xeri-Sprays
- Saves time and money when installing a low-volume irrigation system
- Extremely rugged and reliable PolyFlex Riser constructed of thick-walled, high-density polyethylene

### Operating Range

- Pressure: 15 to 50 psi (1.0 to 3.5 bar)

### Model

- PFR-RS: 12" (30.5 cm) PolyFlex Riser and 7" (30.5 cm) stake

PFR-RS



## Riser Stake-Threaded

### Features

- Rugged 5" (12.7 cm) stake for use with PolyFlex Risers
- Constructed of UV-resistant plastic material
- Barbed side inlet accepts 1/4" Distribution Tubing (XQ)
- 10-32 threaded outlet permits easy threading of 12" (30.5 cm) PolyFlex Riser (PFR-12)

### Operating Range

- Pressure: 15 to 50 psi (1.0 to 3.5 bar)

### Model

- RS-025T

RS-025T



## 10-32 Thread Adapter

### Features

- Inlet: 1/2" FPT that screws onto any 1/2" MPT riser
- Outlet: 10-32 threads that accept Xeri-Bugs, PC Modules, Xeri-Bubblers and Xeri-Sprays with 10-32 threads
- Constructed of UV-resistant plastic material

### Operating Range

- Pressure: 15 to 50 psi (1.0 to 3.5 bar)

### Model

- 10-32A

10-32A



## 1800 Xeri-Bubbler Adapter

### Features

- Inlet: 1/2" female threads that screw onto a Rain Bird 1800 series or UNI-Spray or shrub adapter
- Outlet: 10-32 threads that accept any emission device with 10-32 threads including Xeri-Bugs, PC Modules, Xeri-Bubblers and Xeri-Sprays
- Sits at grade when installed on a spray head for a robust installation

### Operating Range

- Pressure: 15 to 50 psi (1.0 to 3.5 bar)

### Model

- XBA-1800

XBA-1800



## RWS (Root Watering System)

Root Watering System promotes deep root growth, healthy tree development, and accelerated growth

### Features and Benefits

- Subsurface aeration and irrigation prevents tree and shrub transplant shock
- Highest efficiency solution for tree irrigation - up to 95% emission uniformity with minimal wind, evaporation, or edge control losses
- Aesthetically designed subsurface bubbler contributes to a landscape's natural appearance
- Locking grate at grade deters vandals
- Helps prevent shallow root growth and hardscape damage
- Aesthetically attractive below grade installation
- Self-contained and factory assembled units for assured reliability

### For the RWS Model:

- 4" (10.2 cm) retaining cap and vandal resistant locking grate tops a 36" (91.4 cm) semi-rigid mesh tube
- Factory installed swing assemblies (excluding RWS) with a 1401 (0.25 gpm; 0.95 l/m), 1402 (0.5 gpm; 1.9 l/m), or 1404 (1.00 gpm; 3.8 l/m) bubbler on a fixed riser makes connecting to lateral lines easy
- Options: Check valve to keep lines from draining  
Sand sock for use in fine soils

### For the RWS - Mini:

- 4" (10.2 cm) retaining cap and vandal resistant locking grate tops a 18" (45.7 cm) semi-rigid mesh tube
- Factory installed ½" spiral barb elbow with a 1401 or 1402 bubbler makes connecting to lateral lines easy
- Options: Check valve to keep lines from draining  
Sand sock for use in fine soils

### For the RWS - Supplemental:



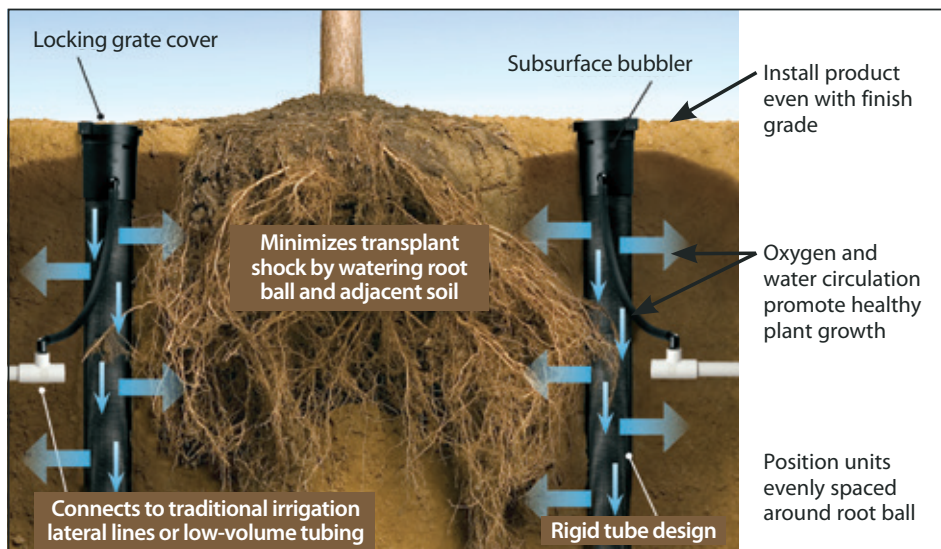





















- 2" (5.1 cm) snap-on cap and base cap enclose a 10" (25.4 cm) semi-rigid mesh tube
- Factory installed ½" spiral barb elbow with PCT or 1401 bubbler makes connecting to lateral lines easy
- Options: Check valve to keep lines from draining  
Sand sock for use in fine soils



Models /Specifications				
Model	Bubbler	Check Valve*	Swing Assembly w/ ½" (15/21) M NPT inlet	Spiral Barb Elbow w/ ½" (15/21) M NPT inlet
<b>Root Watering System (with 4" (10.2 cm) vandal-resistant locking grate)</b>				
RWS	Ideal for ¼" drip tubing or customer provided hardware	–	–	–
RWS-B-C-1401	0.25 gpm (0.95 l/m)	✓ (36")	✓	–
RWS-B-1401	0.25 gpm (0.95 l/m)	–	✓	–
RWS-B-X-1401	0.25 gpm (0.95 l/m)	–	✓ (18" with no elbow)	–
RWS-B-C-1402	0.50 gpm (1.9 l/m)	✓ (36")	✓	–
RWS-B-1402	0.50 gpm (1.9 l/m)	–	✓	–
RWS-B-C-1404	1.00 gpm (3.8 l/m)	✓ (36")	✓	–
<b>Root Watering System - Mini (with 4" (10.2 cm) vandal-resistant locking grate)</b>				
RWS-M	Ideal for ¼" drip tubing or customer provided hardware	–	–	–
RWS-M-B-C-1401	0.25 gpm (0.95 l/m)	✓ (18")	–	✓
RWS-M-B-1401	0.25 gpm (0.95 l/m)	–	–	✓
RWS-M-B-C-1402	0.50 gpm (1.9 l/m)	✓ (18")	–	✓
RWS-M-B-1402	0.50 gpm (1.9 l/m)	–	–	✓
<b>Root Watering System - Supplemental (with 2" (5.1 cm) snap-on cap and base)</b>				
RWS-S-B-C-PCT5	5.0 gph (19 l/m)	✓ (10")	–	✓
RWS-S-B-C-1401	0.25 gpm (0.95 l/m)	✓ (10")	–	✓
RWS-S-B-1401	0.25 gpm (0.95 l/m)	–	–	✓
<b>Root Watering - Accessories</b>				
RWS-SOCK (Root Watering Sock)				
RWS- GRATE-P (Root Watering System Purple Grate for RWS and RWS Mini)				

\*Check Valve is 14 ft. of holdback, or 6 PSI



Tubing	Application	Compatible Fittings	Flow Rates	Emitter Spacing	Coil Lengths	Tubing Diameter	Colors	Special Notes
<b>DRIPLINE</b>								
<b>14" Landscape Dripline</b> 	Planter boxes Container and Vegetable Gardens Shrubs Flowers	 XBF1 CONN  XBF2 EL  XBF3 TEE	0.8 gph	6" 12"	100'	OD: 0.250" ID: 0.170"		Flexible tubing with clog-resistant built-in filtration
<b>XFD On-Surface Dripline</b> 	On-surface Dripline Shrubs Flowers	 XF Dripline Insert Fittings  Easy Fit Compression Fittings	0.6 gph 0.9 gph	12" 18"	100' 250' 500'	OD: 0.634" ID: 0.536"		Extra flexible and dual-layered
<b>XFCV Dripline</b> 	Elevation Changes Shrubs Flowers	 XF Dripline Insert Fittings  Easy Fit Compression Fittings	0.6 gph 0.9 gph	12" 18"	100' 250' 500'	OD: 0.634" ID: 0.536"		Built-in Check Valve
<b>XFS Sub-Surface Dripline</b> 	Tight Planting Areas Switchbacks Turf	 XF Dripline Insert Fittings	0.4 gph 0.6 gph 0.9 gph	12" 18"	100' 500'	OD: 0.634" ID: 0.536"		Copper Shield protects emitters from root intrusion
<b>XFS-CV Sub-Surface Dripline</b> 	Tight Planting Areas Switchbacks Turf	 XF Dripline Insert Fittings	0.4 gph 0.6 gph 0.9 gph	12" 18"	100' 250' 500'	OD: 0.634" ID: 0.536"		Copper Shield protects emitters from root intrusion Check valve
<b>BLANK TUBING</b>								
<b>XBS Black Stripe Tubing</b> 	Five Color Stripe Choices Shrubs Flowers	 1/2": Twist Lock Fittings - 600 Series  3/4": Twist Lock Fittings - 800 Series	—	—	100 500	1/2" OD: 0.700" 1/2" ID: 0.600" 1/2" OD: 0.705" 1/2" ID: 0.615" 3/4" OD: 0.940" 3/4" ID: 0.820"		Color stripes used to differentiate zones
<b>XT-700 Distribution Tubing</b> 	Thick-walled but Flexible Shrubs Flowers	 1/2": Twist Lock Fittings - 600 Series	—	—	100 500	OD: 0.700" ID: 0.580"		Thick-walled, flexible tubing resists kinks
<b>XF Series Blank Tubing</b> 	Shrubs Flowers	 XF Dripline Insert Fittings  Easy Fit Compression Fittings	—	—	100' 250' 500'	OD: 0.634" ID: 0.536"		Extra Flexible
<b>QF Dripline Header</b> 	Pre-fabricated header for dripline installations	 Twist Lock Fittings - 800 Series (For QF Header - 3/4")  Twist Lock Fittings - 1000 Series (For QF Header - 1")	—	12" 18"	100'	3/4" OD: 0.940" 3/4" ID: 0.820" 1" OD: 1.200" 1" ID: 1.060"		Elbows rotate 360° and incorporate a protective ring

Landscape Drip

## XFD On-Surface Dripline

The Most Flexible, Pressure-Compensating In-line Emitter Tubing Available to Irrigate Ground Cover, Dense Plantings, Hedge Rows and More

### Features

- Extra flexible tubing for fast, easy installation
- Dual-layered tubing (brown over black or purple over black) provides unmatched resistance to chemicals, UV damage and algae growth
- Patent pending emitter design provides for increased reliability
- Longer lateral runs than competition
- Unique material offers significantly greater flexibility, allowing tighter turns with fewer elbows for easier installation
- Choice of flow rates, spacing and coil lengths provides design flexibility for a variety of non-turfgrass applications
- Use an Air/Vacuum Relief Valve Kit when installation is below soil (pg 140)

### Operating Range

- Pressure: 8.5 to 60 psi (0.58 to 4.1 bar)
- Flow rates: 0.6 gph and 0.9 gph (2.3 l/h and 3.5 l/h)
- Temperature: Water up to 100° F (37.8C); Ambient up to 125° F (51.7C)
- Required filtration: 120 mesh

### Specifications

- Outside diameter: 0.634" (16.1 mm)
- Inside diameter: 0.536" (13.6 mm)
- Wall thickness: 0.049" (1.2 mm)
- Spacing: 12" or 18"
- Lengths: 100', 250', and 500' coils
- Use with XF Dripline Insert Fittings, Rain Bird Easy Fit Compression Fittings, or Twist Lock Fittings



XFD Dripline



Available in Purple for Non-Potable water



XFD Dripline Offers Improved Flexibility for Kink Resistance and Easy Installation. The Dripline Can Bend Down to a 3" Radius Without Kinking.

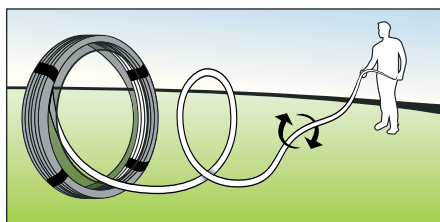

Self-Dispensing Coil Reduces Layout Time and Improves Ease of Installation



XFD Dripline

### How To Specify

#### XFD - P - 09 - 12 - 100

Model XFD Dripline	Length of Tubing 100 = 100' (30.5 m) 250 = 250' (76.2 m) 500 = 500' (152.4 m)
Optional Purple	Emitter Spacing 12 = 12" (30.5 cm) 18 = 18" (45.7 cm)
Flow Rate 06 = .61 gph (2.3 l/h) 09 = .92 gph (3.5 l/h)	



Compatible Fittings



XF Dripline Insert Fittings (pg. 138)



Easy Fit Compression Fittings (pg. 139)



Twist Lock Fittings - 600 Series (pg. 137)

XFD On-Surface Dripline Models

Model	Flow gph	Spacing in.	Coil Length ft.
XFD-06-12-100	0.60	12	100
XFD-06-12-250	0.60	12	250
XFD-06-12-500	0.60	12	500
XFD-06-18-100	0.60	18	100
XFD-06-18-250	0.60	18	250
XFD-06-18-500	0.60	18	500
XFD-09-12-100	0.90	12	100
XFD-09-12-250	0.90	12	250
XFD-09-12-500	0.90	12	500
XFD-09-18-100	0.90	18	100
XFD-09-18-250	0.90	18	250
XFD-09-18-500	0.90	18	500
XFDP-06-12-500 (Purple)	0.60	12	500
XFDP-06-18-500 (Purple)	0.60	18	500
XFDP-09-12-500 (Purple)	0.90	12	500
XFDP-09-18-500 (Purple)	0.90	18	500

XFD On-Surface Dripline Models

METRIC

Model	Flow l/h	Spacing cm	Coil Length m
XFD-06-12-100	2.30	30.5	30.5
XFD-06-12-250	2.30	30.5	76.5
XFD-06-12-500	2.30	30.5	152.4
XFD-06-18-100	2.30	45.7	30.5
XFD-06-18-250	2.30	45.7	76.5
XFD-06-18-500	2.30	45.7	152.4
XFD-09-12-100	3.40	30.5	30.5
XFD-09-12-250	3.40	30.5	76.5
XFD-09-12-500	3.40	30.5	152.4
XFD-09-18-100	3.40	45.7	30.5
XFD-09-18-250	3.40	45.7	76.5
XFD-09-18-500	3.40	45.7	152.4
XFDP-06-12-500 (Purple)	2.30	30.5	152.4
XFDP-06-18-500 (Purple)	2.30	45.7	152.4
XFDP-09-12-500 (Purple)	3.40	30.5	152.4
XFDP-09-18-500 (Purple)	3.40	45.7	152.4

For dripline applications requiring 0.4 gpm flow rate, use XF Series Dripline, page 132.

XFD On-Surface Dripline Maximum Lateral Lengths (Feet)

Inlet Pressure psi	Maximum Lateral Length (feet)			
	12" Spacing		18" Spacing	
	Nominal Flow (gph):		Nominal Flow (gph):	
	0.6	0.9	0.6	0.9
15	273	155	314	250
20	318	169	353	294
30	360	230	413	350
40	395	255	465	402
50	417	285	528	420
60	460	290	596	455

XFD On-Surface Dripline Maximum Lateral Lengths (meters)

Inlet Pressure bar	Maximum Lateral Length (meters)			
	30.5 cm		45.7 cm	
	Nominal Flow (l/h):		Nominal Flow (l/h):	
	2.3	3.4	2.3	3.4
1.0	83.2	47.2	95.7	76.2
1.4	96.9	51.5	107.6	89.6
2.1	109.7	70.1	125.9	106.7
2.8	120.4	77.7	141.7	122.5
3.5	127.1	86.9	160.9	128.0
4.1	140.2	88.4	181.7	138.7

XFD On-Surface Dripline Flow( per 100 Feet of Tubing)

Emitter Spacing	0.6 gph Emitter		0.9 gph Emitter	
	Flow	Flow	Flow	Flow
12"	61.0 gph	1.02 gpm	92.0 gph	1.53 gpm
18"	41.0 gph	0.68 gpm	61.0 gph	1.02 gpm
24"	31.0 gph	0.51 gpm	46.0 gph	0.77 gpm

XFD On-Surface Dripline Flow( per 100 meters of Tubing)

Emitter Spacing	2.3 l/h Emitter		3.4 l/h Emitter	
	Flow	Flow	Flow	Flow
0.30 meter	757.9 l/h	12.6 l/m	1136.7 l/h	18.9 l/m
0.46 meter	502.2 l/h	8.4 l/m	741.3 l/h	12.4 l/m
0.61 meter	378.7 l/h	6.3 l/m	559.0 l/h	9.3 l/m

## XFCV Dripline with Check Valve

Rain Bird® XFCV Dripline with a heavy-duty 3.5 psi check valve for on-surface applications adds a valuable member to the Rain Bird XF Series of Dripline. The XFCV is the most effective dripline in the industry and is ideal for areas where no other dripline will work. When used in applications where elevation changes exist, the patent-pending check valve keeps the dripline charged, holding 8 feet of hold back. Rain Bird's XFCV offers better uniformity and helps to prevent over-watering at the low-point in the zone, avoiding puddling and water draining from the dripline.

It accepts Rain Bird Easy Fit Compression Fittings, XF Dripline Barbed Insert Fittings and other 17 mm barbed insert fittings.

### Features

#### Simple

- Rain Bird's patent-pending 3.5 psi check valve technology keeps the dripline charged with water at all times, increasing uniformity of watering, and conserves water by eliminating the need to recharge the line at the beginning of each watering cycle
- Through the use of a proprietary tubing material, the XFCV Dripline with heavy-duty check valve is the most flexible dripline tubing in the industry, making it the easiest dripline to design with and install
- Rain Bird's low-profile emitter design reduces in-line pressure loss, allowing longer lateral runs, simplifying design and reducing installation time
- Variety of emitter flow rates, emitter spacing and coil lengths provide design flexibility for on-surface areas with or without elevation changes

#### Made with Recycled Content

- All Rain Bird XF Dripline (XFD, XFS, XFCV, XFS-CV) qualify for LEED credit 4.2 because they contain at least 20% Polyethylene post consumer recycled material by cost. These come in an assortment of coil sizes, flow rates and emitter spacing

#### Reliable

- The pressure-compensating emitter design provides a consistent flow over the entire lateral length ensuring higher uniformity for increased reliability in the pressure range of 20 to 60 psi

#### Durable

- Dual-layered tubing (brown over black) provides unmatched resistance to chemicals, algae growth and UV damage

#### Grit Tolerant

- Rain Bird's proprietary emitter design resists clogging by use of an extra wide flow path combined with a self-flushing action



XFCV Dripline for Elevated Applications

With XFCV's built-in 3.5 check valve, all lines are kept charged and up to 8 feet of water is held back

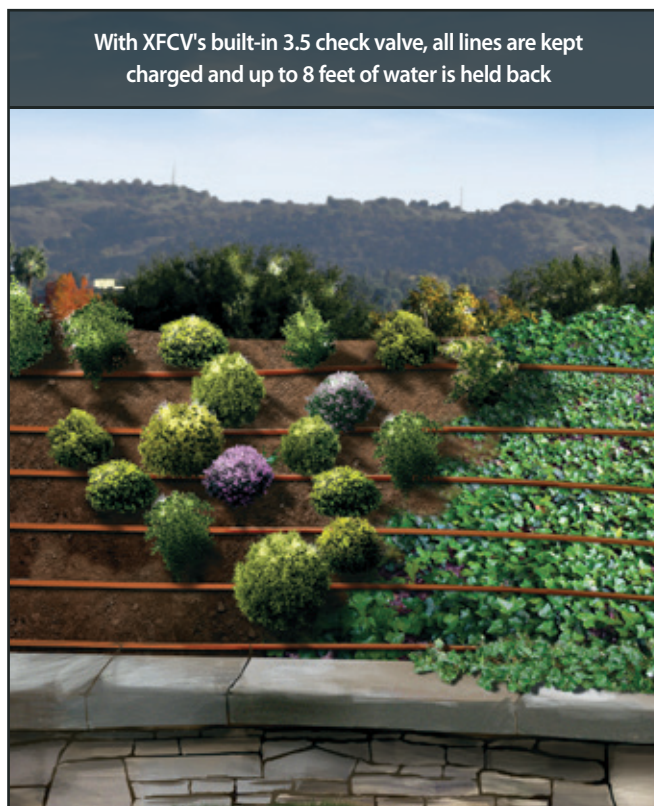

### How To Specify

#### XFCV - 06 - 12 - 100

<p>Model XFCV Dripline with Heavy-Duty Check Valve</p>	<p>Length of Tubing 100 = 100' (30.5 m) 500 = 500' (152.4 m)</p> <p>Emitter Spacing 12 = 12" (30.5 cm) 18 = 18" (45.7 cm)</p> <p>Flow Rate 06 = .61 gph (2.3 l/h) 09 = .92 gph (3.5 l/h)</p>
--	--

**Operating Range**

- Opening Pressure: 14.5 psi
- Pressure: 20 to 60 psi (1.38 to 4.14 bar)
- Flow rates: 0.6 and 0.9 gph (2.3 l/hr and 3.5 l/hr)
- Temperature:
  - Water: Up to 100°F (37.8° C)
  - Ambient: Up to 125°F (51.7° C)
- Required Filtration: 120 mesh

**Specifications**

- Dimensions:
  - OD: 0.634" (16mm)
  - ID: 0.536" (13.6mm);
- Thickness: 0.049" (1.2mm)
- 12" & 18" (30.5 cm, 45.7 cm) spacing
- Available in 100' and 500' (30.5 m and 152.4 m) coils
- Coil Color: Brown
- Use with XF Dripline Insert Fittings, Rain Bird Easy Fit Compression Fittings, or Twist Lock Fittings



XFCV Dripline Models			
Model	Flow gph	Spacing in.	Coil Length ft.
XFCV-06-12-100	0.60	12	100
XFCV-06-12-500	0.60	12	500
XFCV-06-18-100	0.60	18	100
XFCV-06-18-500	0.60	18	500
XFCV-09-12-100	0.90	12	100
XFCV-09-12-500	0.90	12	500
XFCV-09-18-100	0.90	18	100
XFCV-09-18-500	0.90	18	500

XFCV Dripline Models			METRIC
Model	Flow l/h	Spacing cm	Coil Length m
XFCV-06-12-100	2.30	30.5	30.5
XFCV-06-12-500	2.30	30.5	152.4
XFCV-06-18-100	2.30	45.7	30.5
XFCV-06-18-500	2.30	45.7	152.4
XFCV-09-12-100	3.40	30.5	30.5
XFCV-09-12-500	3.40	30.5	152.4
XFCV-09-18-100	3.40	45.7	30.5
XFCV-09-18-500	3.40	45.7	152.4

XFCV Dripline Maximum Lateral Lengths (Feet)				
Inlet Pressure psi	Maximum Lateral Length (feet)			
	12" Spacing		18" Spacing	
	Nominal Flow (gph):		Nominal Flow (gph):	
	0.6	0.9	0.6	0.9
20	192	136	254	215
30	289	205	402	337
40	350	248	498	416
50	397	281	573	477
60	436	309	637	529

XFCV Dripline Maximum Lateral Lengths (Meters)			METRIC	
Inlet Pressure bar	Maximum Lateral Length (meters)			
	30.5 cm		45.7 cm	
	Nominal Flow (l/h):		Nominal Flow (l/h):	
	2.3	3.4	2.3	3.4
1.4	59	41	77	66
2.1	88	63	123	103
2.8	107	76	152	127
3.5	121	86	175	145
4.1	133	94	194	161

Landscape Drip

## XFS Sub-Surface Dripline with Copper Shield™ Technology

Sub-Surface Drip Irrigation (SDI) perfect for small, narrow and tight planting areas, switchbacks, as well as all turf landscapes

Rain Bird® XFS Sub-Surface Copper-Colored Dripline with Copper Shield™ Technology is the latest innovation in the Rain Bird Landscape Drip Family. Rain Bird's patent-pending Copper Shield Technology protects the emitter from root intrusion, creating a long-lasting, low maintenance sub-surface drip irrigation system for use under turf grass or shrub and groundcover areas.

A proprietary tubing material makes the XFS Sub-Surface Dripline with Copper Shield the most flexible tubing in the industry, and the easiest sub-surface dripline to design with and install.

### Features

#### Simple

- Rain Bird's low-profile emitter design reduces in-line pressure loss, allowing longer lateral runs, simplifying design and reducing installation time
- Variety of emitter flow rates, emitter spacing and coil lengths provide design flexibility for either sub-surface turf or sub-surface shrub and groundcover applications

#### Reliable

- XFS Sub-Surface Dripline emitters are protected from root intrusion by Rain Bird's patent-pending Copper Shield™ Technology resulting in a system that does not require maintenance or replacement of chemicals to prevent root intrusion
- The pressure-compensating emitter design provides a consistent flow over the entire lateral length ensuring higher uniformity for increased reliability in the pressure range of 8.5 to 60 psi

#### Durable

- Dual-layered tubing (copper over black) provides unmatched resistance to chemicals, algae growth and UV damage
- Grit Tolerant: Rain Bird's proprietary emitter design resists clogging by use of an extra-wide flow path combined with a self-flushing action

### Operating Range

- Pressure: 8.5 to 60 psi (0.58 to 4.14 bar)
- Flow rates: 0.4 gph, 0.6, and 0.9 gph (1.6 l/h, 2.3 l/hr and 3.5 l/hr)
- Temperature:
  - Water: Up to 100°F (37.8° C)
  - Ambient: Up to 125°F (51.7° C)
- Required Filtration: 120 mesh

### Specifications

- Dimensions: OD: 0.634" (16mm); ID: 0.536" (13.6mm); Thickness: 0.049" (1.2mm)
- 12", 18", (30.5 cm, 45.7 cm, 61.0 cm) spacing
- Available in 100' and 500' (30.5 m and 152.4 m) coils
- Coil Color: Copper
- Use with XF Dripline Insert Fittings or Twist Lock Fittings



XFS Sub-Surface Dripline



Irrigation Association Show Winner

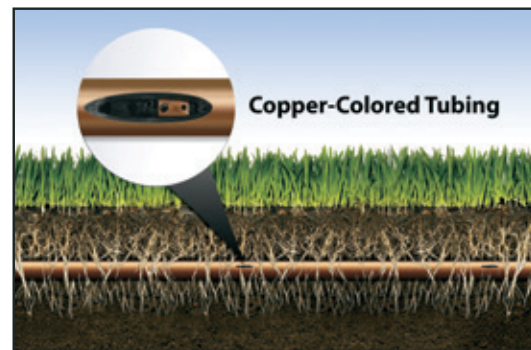

XFS Sub-Surface Dripline with Copper Shield™ Technology



XFS Dripline offers increased flexibility for easy installation

### How To Specify

<b>XFS - P - 09 - 12 - 100</b>	
Optional P = Purple over black	Length of Tubing 100 = 100' (30.5 m) 500 = 500' (152.4 m)
Model XFS Sub-Surface Dripline	Emitter Spacing 12 = 12" (30.5 cm) 18 = 18" (45.7 cm) 24 = 24" (61.0 cm)
	Flow Rate 04 = .42 gph (1.6 l/h) 06 = .61 gph (2.3 l/h) 09 = .92 gph (3.5 l/h)

**XF Dripline Insert Fittings**

XF Dripline Insert Fittings offer a unique barb design to reduce insertion force and still retain a secure fit (p. 138)



XF Dripline Insert Fittings (pg. 138)

We recommend using the XF Insertion Tool (FITINS-TOOL) which lowers the effort required to insert each fitting by 50% (p. 140)



FITINS-TOOL

**XFS Sub-Surface Dripline Models**

Model	Flow gph	Spacing in.	Coil Length ft.
XFS-04-12-100	0.42	12	100
XFS-04-12-500	0.42	12	500
XFS-04-18-100	0.42	18	100
XFS-04-18-500	0.42	18	500
XFS-06-12-100	0.60	12	100
XFS-06-12-500	0.60	12	500
XFS-06-18-100	0.60	18	100
XFS-06-18-500	0.60	18	500
XFS-09-12-100	0.90	12	100
XFS-09-12-500	0.90	12	500
XFS-09-18-100	0.90	18	100
XFS-09-18-500	0.90	18	500
XFSP-04-12-500 (Purple)	0.42	12	500
XFSP-04-18-500 (Purple)	0.42	18	500
XFSP-06-12-500 (Purple)	0.60	12	500
XFSP-06-18-500 (Purple)	0.60	18	500
XFSP-09-12-500 (Purple)	0.90	12	500
XFSP-09-18-500 (Purple)	0.90	18	500

**XFS Sub-Surface Dripline Models**

**METRIC**

Model	Flow l/h	Spacing cm	Coil Length m
XFS-04-12-100	1.60	30.5	30.5
XFS-04-12-500	1.60	30.5	152.4
XFS-04-18-100	1.60	45.7	30.5
XFS-04-18-500	1.60	45.7	152.4
XFS-06-12-100	2.30	30.5	30.5
XFS-06-12-500	2.30	30.5	152.4
XFS-06-18-100	2.30	45.7	30.5
XFS-06-18-500	2.30	45.7	152.4
XFS-09-12-100	3.50	30.5	30.5
XFS-09-12-500	3.50	30.5	152.4
XFS-09-18-100	3.50	45.7	30.5
XFS-09-18-500	3.50	45.7	152.4
XFSP-04-12-500 (Purple)	1.60	30.5	152.4
XFSP-04-18-500 (Purple)	1.60	45.7	152.4
XFSP-06-12-500 (Purple)	2.30	30.5	152.4
XFSP-06-18-500 (Purple)	2.30	45.7	152.4
XFSP-09-12-500 (Purple)	3.50	30.5	152.4
XFSP-09-18-500 (Purple)	3.50	45.7	152.4

**XFS Sub-Surface Dripline Maximum Lateral Lengths (Feet)**

Inlet Pressure psi	Maximum Lateral Length (feet)					
	12" Spacing			18" Spacing		
	Nominal Flow (gph):			Nominal Flow (gph):		
	0.42	0.6	0.9	0.42	0.6	0.9
15	352	273	155	374	314	250
20	399	318	169	417	353	294
30	447	360	230	481	413	350
40	488	395	255	530	465	402
50	505	417	285	610	528	420
60	573	460	290	734	596	455

**XFS Sub-Surface Dripline Maximum Lateral Lengths (meters)**

Inlet Pressure bar	Maximum Lateral Length (meters)					
	30.5 cm			45.7 cm		
	Nominal Flow (l/h):			Nominal Flow (l/h):		
	1.6	2.3	3.4	1.6	2.3	3.4
1.0	107.2	83.2	47.2	114	95.7	76.2
1.4	121.6	96.9	51.5	127.1	107.6	89.6
2.1	136.2	109.7	70.1	146.6	125.9	106.7
2.8	148.7	120.4	77.7	161.5	141.7	122.5
3.5	153.9	127.1	86.9	185.9	160.9	128.0
4.1	174.6	140.2	88.4	223.7	181.7	138.7

**XFS Sub-Surface Dripline Flow( per 100 Feet of Tubing)**

Emitter Spacing	0.42 gph Emitter		0.6 gph Emitter		0.9 gph Emitter	
	gph	gpm	gph	gpm	gph	gpm
12"	42.0 gph	0.70 gpm	61.0 gph	1.02 gpm	92.0 gph	1.53 gpm
18"	28.0 gph	0.47 gpm	41.0 gph	0.68 gpm	61.0 gph	1.02 gpm

**XFS Sub-Surface Dripline Flow( per 100 Meters of Tubing)**

Emitter Spacing	1.6 l/h Emitter		2.3 l/h Emitter		3.4 l/h Emitter	
	l/h	l/m	l/h	l/m	l/h	l/m
0.30 meter	531.1 l/h	8.85 l/m	757.9 l/h	12.6 l/m	1136.7 l/h	18.9 l/m
0.46 meter	351.8 l/h	5.86 l/m	502.2 l/h	8.4 l/m	741.3 l/h	12.4 l/m

## XFS-CV Dripline with Heavy-Duty Check Valve

NEW

Rain Bird® XFS-CV Dripline with an improved 4.3 psi check valve delivers 10 feet of hold-back – the highest in the industry. With pure copper chips in every emitter to protect against emitter root intrusion, XFS-CV dripline is an all-in-one dripline suitable for any application – on-surface, sub-surface, sloped or level-grade. When used in applications where elevation changes exist, the patent-pending check valve keeps the dripline charged with water, delivering better irrigation uniformity while preventing over-watering and puddling at the low-point in the zone.

It accepts Rain Bird XF Dripline Barbed Insert Fittings, RB 600 Series Twist Lock Fittings, and other 17 mm barbed insert fittings.

A proprietary tubing material makes the XFS Sub-Surface Dripline with Copper Shield the most flexible tubing in the industry, and the easiest sub-surface dripline to design with and install.

### Features

#### Simple

- Rain Bird's patent-pending 4.3 psi check valve technology keeps the dripline charged with water at all times, increasing uniformity of watering, and conserves water by eliminating the need to recharge the line at the beginning of each watering cycle
- XFS-CV Sub-Surface Dripline emitters are protected from root intrusion by Rain Bird's patent-pending Copper Shield™ Technology resulting in a system that does not require maintenance or replacement of chemicals to prevent root intrusion. Through the use of a proprietary tubing material, the XFS-CV Dripline with heavy-duty check valve is the most flexible dripline tubing in the industry, making it the easiest dripline to design with and install
- Rain Bird's low-profile emitter design reduces in-line pressure loss, allowing longer lateral runs, simplifying design and reducing installation time
- Variety of standard emitter flow rates, emitter spacing and coil lengths provide design flexibility for sub-surface and on-surface areas with or without elevation changes

#### Made with Recycled Content

- All Rain Bird XF Dripline (XFD, XFS, XFCV, XFS-CV) qualify for LEED credit 4.2 because they contain at least 20% Polyethylene post consumer recycled material by cost. These come in an assortment of coil sizes, flow rates and emitter spacing

#### Reliable

- The pressure-compensating emitter design provides a consistent flow over the entire lateral length ensuring higher uniformity for increased reliability in the pressure range of 20 to 60 psi

#### Durable

- Dual-layered tubing (copper over black) provides unmatched resistance to chemicals, algae growth and UV damage

#### Grit Tolerant

- Rain Bird's proprietary emitter design resists clogging by use of an extra wide flow path combined with a self-flushing action



XFS-CV Dripline for Elevated Applications

With XFS-CV's built-in 4.3 check valve, all lines are kept charged and up to 10 feet of water is held back

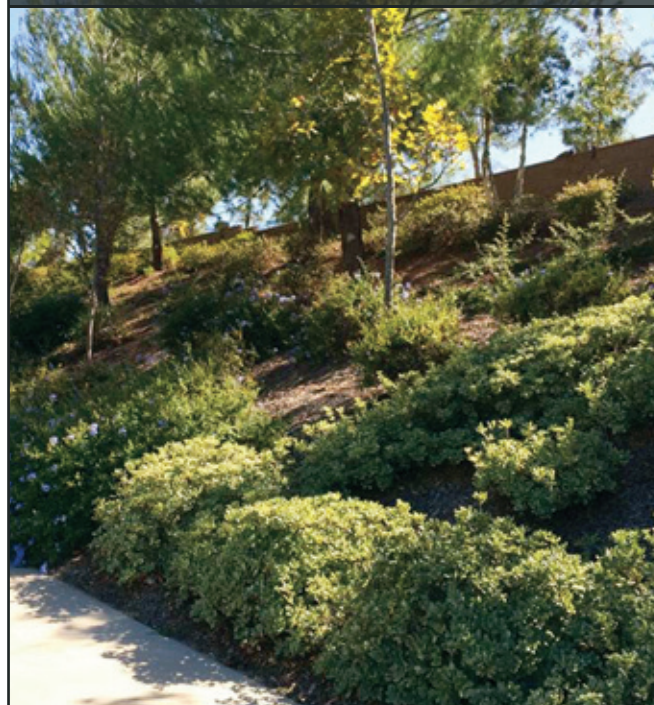

Landscape Drip



### How To Specify

#### XFS-CV - 06 - 12 - 100

Model XFS-CV Dripline with Heavy-Duty Check Valve	Length of Tubing
	100 = 100' (30.5 m)
	250 = 250' (76.2 m)
	500 = 500' (152.4 m)
Emitter Spacing	12 = 12" (30.5 cm)
	18 = 18" (45.7 cm)
	Flow Rate
04 = .42 gph (1.6 l/h)	
06 = .61 gph (2.3 l/h)	
09 = .92 gph (3.5 l/h)	

### Operating Range

- Opening Pressure: 14.5 psi
- Pressure: 20 to 60 psi (1.38 to 4.14 bar)
- Flow rates: 0.6 and 0.9 gph (2.3 l/hr and 3.5 l/hr)
- Temperature:
  - Water: Up to 100°F (37.8° C)
  - Ambient: Up to 125°F (51.7° C)
- Required Filtration: 120 mesh

### Specifications

- Dimensions:
  - OD: 0.634" (16mm)
  - ID: 0.536" (13.6mm);
- Thickness: 0.049" (1.2mm)
- 12" & 18" (30.5 cm, 45.7 cm) spacing
- Available in 100', 250' and 500' (30.5 m, 76.2 m and 152.4 m) coils
- Coil Colors: Copper, purple, purple stripe
- Use with XF Dripline Insert Fittings or Twist Lock Fittings

#### XF Dripline Insert Fittings

XF Dripline Insert Fittings offer a unique barb design to reduce insertion force and still retain a secure fit (p. 138)



XF Dripline Insert Fittings (pg. 138)

We recommend using the XF Insertion Tool (FITINS-TOOL) which lowers the effort required to insert each fitting by 50% (p. 140)



FITINS-TOOL

#### XFS-CV Dripline Maximum Lateral Lengths (Feet)

Inlet Pressure psi	Maximum Lateral Length (feet)			
	12" Spacing		18" Spacing	
	Nominal Flow (gph):		Nominal Flow (gph):	
	0.6	0.9	0.6	0.9
20	192	136	254	215
30	289	205	402	337
40	350	248	498	416
50	397	281	573	477
60	436	309	637	529

#### XFS-CV Dripline Maximum Lateral Lengths (Meters) METRIC

Inlet Pressure bar	Maximum Lateral Length (meters)			
	30.5 cm		45.7 cm	
	Nominal Flow (l/h):		Nominal Flow (l/h):	
	2.3	3.4	2.3	3.4
1.4	59	41	77	66
2.1	88	63	123	103
2.8	107	76	152	127
3.5	121	86	175	145
4.1	133	94	194	161



## QF Dripline Header

NEW

A Quick and Flexible Solution to Dripline Headers

The QF Dripline Header is a patent pending product that is the landscape industry's first pre-fabricated header for dripline installations. A Quick and Flexible replacement for a site-built header, the QF Dripline Header saves time and labor expense. Using a proprietary blend of polyethylene, similar to Rain Bird's XF Series Dripline, the QF Dripline header allows installers to simply roll out the header and attach the dripline at guaranteed 12" or 18" spacing. Eliminating the need for measuring, cutting, gluing and taping, the QF Dripline Header saves time and money, making projects more profitable.

### Features

- The QF Dripline Header elbows rotate 360° and incorporate a protective ring — preventing damage and ensuring a proper seal.
- The ring also provides leverage to make attaching the dripline easier.
- The rotating barb manages trenching misalignment. Move left or right to accommodate the dripline – no need to re-trench.
- Elbows utilize the same design as Rain Bird's popular XFF Fitting requiring 50% less insertion force, and are compatible with the XFF Fittings Tool.

### Specifications

	QF Header - 3/4"	QF Header - 1"
• Outside Diameter:	0.940" (23.9mm)	1.200" (30.5mm)
• Inside Diameter:	0.820" (20.8mm)	1.060" (26.9mm)
• Wall Thickness:	0.060" (1.5mm)	0.070" (1.8mm)

### Models

- XQF7512100: XQF 3/4" Dripline Header (12" Spacing 100' Coil)
- XQF7518100: XQF 3/4" Dripline Header (18" Spacing 100' Coil)
- XQF1012100: XQF 1" Dripline Header (12" Spacing 100' Coil)
- XQF1018100: XQF 1" Dripline Header (18" Spacing 100' Coil)
- XQF101210P: XQF 1" Dripline Header (12" Spacing 100' Coil) Purple
- XQF101810P: XQF 1" Dripline Header (18" Spacing 100' Coil) Purple



QF Dripline Header

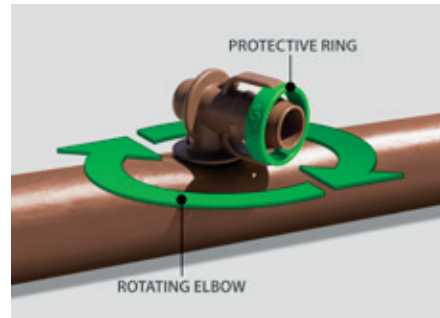

### Compatible Fittings



Twist Lock Fittings  
800 Series (pg. 137)  
(For QF Header - 3/4")



Twist Lock Fittings  
1000 Series (pg. 137)  
(For QF Header - 1")



### How To Specify

<b>XQF - 75 - 12 - 100</b>			
<table border="0"> <tr> <td style="vertical-align: top;"> <p>Dripline Diameter: 75 = 3/4" 10 = 1"</p> </td> <td style="vertical-align: top;"> <p>Emitter Spacing 12 = 12" (30.5 cm) 18 = 18" (45.7 cm)</p> </td> <td style="vertical-align: top;"> <p>Coil Length 100 = 100' (30.5 m) 10P = 100' Purple</p> </td> </tr> </table>	<p>Dripline Diameter: 75 = 3/4" 10 = 1"</p>	<p>Emitter Spacing 12 = 12" (30.5 cm) 18 = 18" (45.7 cm)</p>	<p>Coil Length 100 = 100' (30.5 m) 10P = 100' Purple</p>
<p>Dripline Diameter: 75 = 3/4" 10 = 1"</p>	<p>Emitter Spacing 12 = 12" (30.5 cm) 18 = 18" (45.7 cm)</p>	<p>Coil Length 100 = 100' (30.5 m) 10P = 100' Purple</p>	
<p>Model XQF: Xerigation® Quick Flexible</p>			



## Twist Lock Fittings

NEW

Durable and Reliable. Rain Bird's NEW Twist Lock Fittings

- Complete line of Twist Lock Fittings to simplify installation of QF Header, Dripline and Blank Distribution Tubing
- Fittings provide an even tighter seal on tubing by using high quality barbs and twist locking nuts
- Unique barb design reduces insertion force while maintaining a secure fit

### Operating Range

- Pressure: 0 to 60 psi (0 to 4.1 bar)

### Models

#### 600 SERIES (1/2"):

- TLF-CUPL-0600: Twist Lock Fitting 1/2" Coupler
- TLF-TEE-0600: Twist Lock Fitting 1/2" Tee
- TLF-ELBW-0600: Twist Lock Fitting 1/2" Elbow
- TLF-MPT6-0600: Twist Lock Fitting 1/2" NPT to 1/2" Adaptor
- TLF-MPT8-0600: Twist Lock Fitting 3/4" NPT to 1/2" Adaptor

#### 800 SERIES (3/4"):

- TLF-CUPL-0800: Twist Lock Fitting 3/4" Coupler
- TLF-TEE-0800: Twist Lock Fitting 3/4" Tee
- TLF-ELBW-0800: Twist Lock Fitting 3/4" Elbow
- TLF-MPT8-0800: Twist Lock Fitting 3/4" NPT Adaptor
- TLF-CAP-0800: Twist Lock Fitting 3/4" Cap

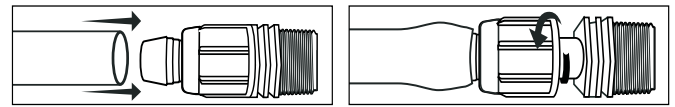

2 Step Installation

#### 1000 SERIES (1"):

- TLF-CUPL-1000: Twist Lock Fitting 1" Coupler
- TLF-TEE-1000: Twist Lock Fitting 1" Tee
- TLF-ELBW-1000: Twist Lock Fitting 1" Elbow
- TLF-MPT8-1000: Twist Lock Fitting 1" NPT Adaptor

	600 Series		800 Series		1000 Series	
	Inches	mm	Inches	mm	Inches	mm
Acceptable Internal Diameter	0.590 to 0.630	15 to 16	0.790 to 0.845	20.0 to 21.5	1.025 to 1.085	26.0 to 27.6
Acceptable Wall Thickness	0.025 to 0.050	0.64 to 1.27	0.045 to 0.065	1.14 to 1.65	0.045 to 0.065	1.14 to 1.65
Compatible Tubing	XFD, XT700, 1/2" XBS		3/4" XBS, 3/4" QF Header		1" QF Header	



600 Series  
(1/2")

800 Series  
(3/4")

1000 Series  
(1")

## XF Dripline Insert Fittings

### Features

- Complete line of 17mm insert fittings to simplify installation of XF Series Dripline
- High quality barbs grab tubing for a secure fit
- Unique barb design to reduce insertion force and still retain a secure fit
- Non-obtrusive colored fittings to compliment natural earth tones

### Operating Range

- Pressure: 0 to 50 psi (1.0 to 3.5 bar) if using 60 psi (4.1 bar) clamps will be required

### Models

- XFF-COUP: 17mm Barb x Barb Coupling
- XFF-ELBOW: 17mm Barb x Barb Elbow
- XFF-MA-050: 17mm Barb x 1/2" MPT Male Adapter
- XFF-TEE: 17mm Barb x Barb x Barb Tee
- XFF-TMA-050: 17mm Barb x 1/2" MPT x 17mm Barb Tee Male Adapter
- XFF-MA-075: 17mm Barb x 3/4" MPT Male Adapter
- XFF-FA-050: Low profile barb elbow female adapter 17mm x 1/2" FPT
- XFF-TFA-050: Low profile barb tee female adapter 17mm x 1/2" FPT x 17mm
- XFD-CROSS: Barb cross 17mm x 17mm x 17mm x 17mm
- XFD-TFA-075: Barb tee female adapter 17mm x 3/4" FPT x 17mm
- LD16STK: 7 3/4" barbed tubing plastic stake
- FITINS-TOOL: XF Fitting Insertion Tool. Compatible with XFF-COUP, XFF-ELBOW, XFF-TEE, and QF Dripline Header



### XF Insert Fittings 17mm

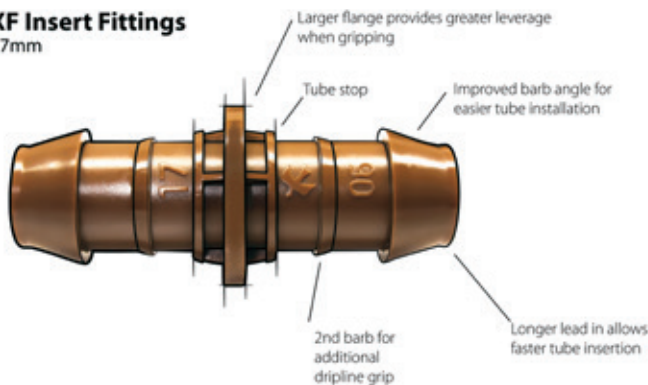

We recommend using the XF Insertion Tool (FITINS-TOOL) which lowers the effort required to insert each fitting by 50% (p. 140)



FITINS-TOOL

## Easy Fit Compression Fitting System

Complete system of compression fittings and adapters for all tubing connection needs in a low-volume system

### Features

- Reduces inventory costs: Multi-diameter compression fittings work with a wide range of 16mm - 17mm tubing or dripline
- Saves time and effort: 50% less force is required to connect tubing and fittings versus competitive compression fittings. Adapters swivel for easy installation
- Provides increased flexibility: Just three Easy Fit Fittings and five Easy Fit Adapters are needed to make over 160 combinations of connections, accommodating countless installation and maintenance situations
- Works with all 16-17mm dripline and blank tubing
- Patented fittings and adapters are molded from UV-resistant and durable ABS materials
- Removable flush caps can be used to flush end of line and temporarily cap off lines for later expansion
  - Not recommended with subsurface irrigation

### Operating Range

- Pressure: 0 to 60 psi (0 to 4.1 bar)
- Accepts tubing with an O.D. of 0.630" to 0.669" (16-17mm)
- Recommended for use above surface only

### Models

#### • Easy Fit Fittings

- MDCF-COUP: Coupling
- MDCF-EL: Elbow
- MDCF-TEE: Tee

#### • Easy Fit Adapters

- MDCF-50MPT: 1/2" Male Pipe Thread Adapter
- MDCF-75MPT: 3/4" Male Pipe Thread Adapter
- MDCF-50FPT: 1/2" Female Pipe Thread Adapter
- MDCF-75FPT: 3/4" Female Pipe Thread Adapter
- MDCF-75FHT: 3/4" Female Hose Thread Adapter
- MDCF-CAP: Removable Flush Cap For Easy Fit Fittings (Black)
- MDCF-PCAP: Removable Flush Cap For Easy Fit Fittings (Purple, to designate non-potable water)

*Note: Easy Fit Adapters are not barbed fittings. They are to be used only with Easy Fit Compression Fittings.*

### Friction Loss per Fitting

Flow gpm	Loss psi	METRIC Flow l/h	Loss bar
0.00	0.00	0.00	0.00
1.00	0.39	227.1	0.03
2.00	0.64	454.3	0.04
3.00	0.82	681.4	0.06
4.00	1.45	908.5	0.10
5.00	1.90	1135.6	0.13
6.00	2.57	1362.8	0.18

*Note: Use of fittings at flows shown in dark shaded area is not recommended.*



### XF Insertion Tool

The XF Insertion Tool reduces the effort required to insert the fittings into the tube by 50%.

#### Features

- 50% Less effort required to install fittings than without a tool
- Firmly locks fittings into place while inserting Dripline
- Tool helps widen the dripline opening to make the fitting insertion easier
- Solid grip and comfortable fit in hand

#### Model

- FITINS-TOOL



FITINS-TOOL

The XF Insertion Tool works with the following XF Fittings:



XFF-COUP

XFF-ELBOW

XFF-TEE



The XF Insertion Tool securely locks fittings into place to make inserting dripline easier.



The tool also has a sloped valley to allow room for the dripline when inserting a fitting onto the second side.

### Air/Vacuum Relief Valve Kit

#### Features

- Use with Rain Bird XF-Series or Landscape Dripline inline emitter tubing when installation is below soil\*
- Made of quality rust-proof materials
- Fits inside an SEB 7XB emitter box

*\*Rain Bird recommends XFS dripline with Copper Shield™ for subsurface installations, including installations under turf grass.*

#### Model

- ARV050: 1/2" Air Relief Valve



ARV050

Maximum Length of Dripline Useable with the ARV		
1/2" ARV		
Emitter Spacing	0.6 GPH	0.9 GPH
12"	639'	424'
18"	958'	636'
24"	1278'	848'
ARV Capacity		
Total Flow (GPM)	6.5	
Total Flow (GPH)	390	

Maximum Length of Dripline Useable with the ARV		
1/2" ARV		
Emitter Spacing	2.3 l/h	3.4 l/h
0.30 m	195	129
0.46 m	292	194
0.61 m	390	258
ARV Capacity		
Total Flow (l/m)	24.6	
Total Flow (l/h)	1476	

#### Install Air/Vacuum Relief Valves correctly by:

Locate at the highest point(s) of the dripline zone. Install the valve in an exhaust header or a line that runs perpendicular to the lateral rows to ensure all rows of the dripline can take advantage of the air/vacuum relief valve

### Drip System Operation Indicator

#### Features

- Stem rises 6" for clear visibility
- When stem is extended, drip system is charged to a minimum of 20 psi
- VAN Nozzle is tightened to no flow but can be opened to observe wetting pattern
- Includes 16" of 1/4" distribution tubing with connection fitting pre-installed

#### Model

- OPERIND



OPERIND

## XF Series Blank Tubing

### Features:

- Greater flexibility is easier to install and saves time
- Brown color matches landscape and blends with mulch. Matches XF Series Dripline inline emitter tubing
- Compatible with XF Series Dripline (0.536" I.D. x 0.634" O.D.)
- Accepts Rain Bird Easy Fit Compression Fittings, XF Dripline Insert Fittings, and 17mm insert fittings
- Not compatible with 16 mm fittings

### Specifications

- Outside Diameter: 0.634" (16.1mm)
- Inside Diameter: 0.536" (13.6mm)
- Wall Thickness: 0.049" (1.2mm)



XFD100

### Models:

- XFD100: 100 ft. coil (30m)
- XFD250: 250 ft. coil (76m)
- XFD500: 500 ft. coil (152m)

### XF Blank Tubing Friction Loss Characteristics

O.D. .634" I.D. .536"			O.D. 16.1mm I.D. 13.6mm METRIC		
Flow gpm	Velocity fps	Loss psi	Flow l/h	Velocity m/s	Loss bar
0.50	0.70	0.27	113.56	0.21	0.06
1.00	1.40	0.97	227.12	0.43	0.22
1.50	2.10	2.06	340.69	0.64	0.46
2.00	2.80	3.50	454.25	0.85	0.79
2.50	3.50	5.29	567.81	1.07	1.20
3.00	4.20	7.42	681.37	1.28	1.68
3.50	4.90	9.87	794.94	1.49	2.23
4.00	5.60	12.64	908.50	1.71	2.86
4.50	6.30	15.72	1022.06	1.92	3.56
5.00	7.00	19.11	1135.62	2.13	4.32
5.50	7.70	22.80	1249.19	2.35	5.16
6.00	8.40	26.78	1362.75	2.56	6.06

Psi Loss Per 100 Feet of Pipe (psi/100ft.)

bar Loss per 100 Meters of Pipe (bar/100m)

**Note:** Use of tubing at flows shown in dark shaded area is not recommended, as velocities exceed 5 ft/sec (1.5 m/s)

## XT-700 Distribution Tubing

Durable, thick-walled distribution tubing stands up to harsh conditions and performs well in all climates

### Features

- Thick-walled, flexible tubing resists kinks and damage caused by routine landscape maintenance activities
- Extruded from UV-resistant polyethylene resin materials

### Operating Range

- Pressure: 0 to 60 psi (0 to 4.1 bar)

### Specifications

- Outside diameter: 0.700" (18 mm)
- Inside diameter: 0.580" (15 mm)
- Wall thickness: 0.06" (1.5 mm)



XT-700-100

### Models

- XT-700-100: 100-foot coil (30 m)
- XT-700-500: 500-foot coil (152 m)

*Note: For both water conservation and appearance, it is recommended that a 2" to 3" (5 to 8 cm) mulch cover be placed on top of the tubing*

### XT-700 Tubing Friction Loss Characteristics

O.D. .700" I.D. .580"			O.D. 18 mm I.D. 15 mm METRIC			
Flow gpm	Velocity fps	Loss psi	Flow m <sup>3</sup> /h	Flow l/h	Velocity m/s	Loss bar
0.50	0.61	0.19	0.11	0.03	0.19	0.01
1.00	1.21	0.69	0.23	0.06	0.37	0.05
1.50	1.82	1.45	0.34	0.09	0.56	0.10
2.00	2.43	2.47	0.45	0.13	0.74	0.17
2.50	3.03	3.74	0.57	0.16	0.92	0.26
3.00	3.64	5.24	0.68	0.19	1.11	0.36
3.50	4.24	6.97	0.79	0.22	1.29	0.48
4.00	4.85	8.93	0.91	0.25	1.48	0.62
4.50	5.46	11.10	1.02	0.28	1.67	0.77
5.00	6.06	13.50	1.14	0.32	1.85	0.93
5.50	6.67	16.10	1.25	0.35	2.03	1.11
6.00	7.28	18.92	1.36	0.38	2.22	1.31

Psi Loss per 100 Feet of Pipe (psi/100ft.) bar Loss per 100 Meters of Pipe (bar/100m)

**Note:** Use of tubing at flows shown in dark shaded area is not recommended, as velocities exceed 5 ft/sec (1.5 m/s)

### Compatible Fittings



Twist Lock Fittings  
600 Series (pg. 137)  
XF Series, XT-700, & 1/2" XBS

Twist Lock Fittings  
800 Series (pg. 137)  
3/4" XBS

### XBS - Black Stripe Tubing

High quality, flexible tubing for use in any low-volume irrigation system

#### Features

- 1/2" & 3/4" blank tubing extruded from polyethylene resin materials for consistent durability
- 1/2" tubing is now available in two different sizes: 0.600" I.D. X 0.700" O.D. and 0.615" I.D. X 0.705" O.D.
- Available in five color stripes to differentiate zones
- UV-resistant for installations at or below grade
- Compact coils for easy storage and shipping

#### Operating Range

- Pressure: 0 to 60 psi (0 to 4.1 bar)

#### Models

##### XBS 700 - 1/2" Tubing Models - 600-700 NEW

- Outside diameter: 0.700" (17.8 mm)
- Inside diameter: 0.600" (15.2 mm)
- Wall thickness: 0.050" (1.3 mm)
- XBS700G100: 1/2" tubing, 100 foot (30 m) coil with green striping
- XBS700G500: 1/2" tubing, 500 foot (152 m) coil with green striping
- XBS700P100: 1/2" tubing, 100 foot (30 m) coil with purple striping
- XBS700P500: 1/2" tubing, 500 foot (152 m) coil with purple striping

##### XBS - 1/2" Tubing Models

- Outside diameter: 0.705" (18 mm)
- Inside diameter: 0.615" (15.6 mm)
- Wall thickness: 0.045" (1.2 mm)
- XBS100: 1/2" tubing, 100 foot (30 m) coil with green striping
- XBS500: 1/2" tubing, 500 foot (152 m) coil with green striping
- XBS500B: 1/2" tubing, 500 foot (152 m) coil with black striping
- XBS500R: 1/2" tubing, 500 foot (152 m) coil with red striping
- XBS500Y: 1/2" tubing, 500 foot (152 m) coil with yellow striping
- XBS500P: 1/2" tubing, 500 foot (152 m) coil with purple striping

##### XBS 940 - 3/4" Tubing Models

- Outside diameter: 0.940" (24 mm)
- Inside diameter: 0.820" (21 mm)
- Wall thickness: 0.060" (1.5 mm)
- XBS940G500: 3/4" tubing, 500 foot (152 m) coil with green striping
- XBS940P500: 3/4" tubing, 500 foot (152 m) coil with purple striping



Black Stripe Tubing

#### XBS 700 - 1/2" Tubing Friction Loss Characteristics NEW

O.D. .700" I.D. .600"			O.D. 17.8mm I.D. 15.2mm METRIC		
Flow (gpm)	Velocity fps	Loss psi	Flow l/m	Velocity m/s	Loss bar
0.50	0.57	0.16	1.89	0.17	0.04
1.00	1.14	0.58	3.79	0.35	0.13
1.50	1.70	1.22	5.68	0.52	0.27
2.00	2.27	2.08	7.57	0.69	0.46
2.50	2.84	3.15	9.46	0.87	0.70
3.00	3.41	4.41	11.36	1.04	0.98
3.50	3.97	5.87	13.25	1.21	1.30
4.00	4.54	7.52	15.14	1.38	1.67
4.50	5.11	9.35	17.03	1.56	2.07
5.00	5.68	11.36	18.93	1.73	2.16
5.50	6.24	13.55	20.82	1.90	3.01
6.00	6.81	15.92	22.71	2.08	3.53

#### XBS - Tubing Friction Loss Characteristics

O.D. .705" I.D. .615"			O.D. 18mm I.D. 15.6mm METRIC		
Flow (gpm)	Velocity fps	Loss psi	Flow l/m	Velocity m/s	Loss bar
0.50	0.54	0.14	1.89	0.16	0.03
1.00	1.08	0.51	3.79	0.33	0.11
1.50	1.62	1.08	5.68	0.49	0.24
2.00	2.16	1.85	7.57	0.66	0.41
2.50	2.70	2.79	9.46	0.82	0.62
3.00	3.24	3.91	11.36	0.99	0.87
3.50	3.78	5.20	13.25	1.15	1.15
4.00	4.32	6.66	15.14	1.32	1.48
4.50	4.86	8.29	17.03	1.48	1.84
5.00	5.40	10.08	18.93	1.65	2.23
5.50	5.94	12.02	20.82	1.81	2.67
6.00	6.48	14.12	22.71	1.98	3.13

#### XBS 940 - 3/4" Tubing Friction Loss Characteristics

OD .940" ID .820"			OD 23.9mm ID 20.8mm METRIC		
Flow (gpm)	Velocity fps	Loss psi	Flow l/m	Velocity m/s	Loss bar
0.50	0.30	0.03	1.89	0.09	0.01
1.00	0.61	0.13	3.79	0.19	0.03
1.50	0.91	0.27	5.68	0.28	0.06
2.00	1.22	0.46	7.57	0.37	0.10
2.50	1.52	0.69	9.46	0.46	0.15
3.00	1.82	0.96	11.36	0.55	0.21
3.50	2.13	1.28	13.25	0.65	0.28
4.00	2.43	1.64	15.14	0.74	0.36
4.50	2.74	2.04	17.03	0.84	0.45
5.00	3.04	2.49	18.93	0.93	0.55
5.50	3.34	2.96	20.82	1.02	0.66
6.00	3.65	3.48	22.71	1.11	0.77
6.50	3.95	4.04	24.61	1.20	0.90
7.00	4.25	4.63	26.50	1.30	1.03
7.50	4.56	5.27	28.39	1.39	1.17
8.00	4.86	5.93	30.28	1.48	1.32
8.50	5.17	6.64	32.18	1.58	1.47
9.00	5.47	7.38	34.07	1.67	1.64
9.50	5.77	8.16	35.96	1.76	1.81
10.00	6.08	8.97	37.85	1.85	1.99

Psi Loss Per 100 Feet of Pipe (psi/100ft.)

Bar Loss per 100 Meters of Pipe (bar/100m)

Note: Use of tubing at flows shown in dark shaded area is not recommended, as velocities exceed 5 ft/sec (1.5 m/s)

## XQ 1/4" Distribution Tubing

The strongest and most flexible 1/4" Distribution Tubing available to extend emitter outlets to desirable discharge locations

### Features

- Unique blend of polymers that give it the flexibility of vinyl with hold of poly
- New textured finish improves handling
- Self extracting coiling feature makes it easy to use, store and eliminates waste
- Fits over barbed outlet ports and all Xerigation® emission devices and 1/4" transfer fittings
- Extruded from UV-resistant polyethylene resin materials

### Specifications

- Outside Diameter: 0.25" (6.3 mm) • Wall Thickness: .04" (1.0 mm)
- Inside Diameter: 0.17" (4.3 mm) • Lengths: 100' and 1000' coils

### Operating Range

- Pressure: 0 to 60 psi (0 to 4.1 bar)

### Models

- XQ-100: 100-foot (30m) coil 1/4" distribution tubing
- XQ-1000: 1000-foot (305m) coil 1/4" distribution tubing
- XQ-1000-B: 1000-foot (305m) coil 1/4" distribution tubing in a bucket

### XQ 1/4" Distribution Tubing Friction Loss Characteristics

O.D. .25" I.D. .17"			O.D. 6.3mm I.D. 4.3mm METRIC			
Flow gph	Velocity fps	Loss psi	Flow m <sup>3</sup> /h	Flow l/h	Velocity m/s	Loss bar
1	0.27	0.16	0.00	3.79	0.08	0.01
3	0.80	1.24	0.01	11.6	0.24	0.09
5	1.33	3.20	0.02	18.92	0.41	0.22
7	1.86	5.97	0.03	26.50	0.57	0.41
9	2.39	9.50	0.03	34.07	0.73	0.66
11	2.92	13.79	0.04	41.64	0.89	0.95
13	3.45	18.75	0.05	49.21	1.05	1.29
15	3.98	24.43	0.06	56.78	1.21	1.69
17	4.52	30.80	0.06	64.35	1.38	2.13
18	4.78	34.23	0.07	68.13	1.46	2.36
19	5.05	37.83	0.07	71.92	1.54	2.61
20	5.31	41.60	0.08	75.70	1.62	2.87
25	6.64	62.86	0.09	94.63	2.03	4.34
30	7.97	88.08	0.11	113.55	2.43	6.08

Psi Loss Per 100 Feet of tubing; C=150 Bar Loss per 100 Meters of tubing

**Note:** Use of tubing at flows shown in dark shaded area is not recommended, as velocities exceed 5 ft/sec (1.5 m/s)



XQ-100 and XQ-1000 1/4" Tubing



XQ-1000-B 1/4" Tubing

## 1/4" Landscape Dripline

Rain Bird 1/4" Dripline is a perfect choice for small-sized areas such as planter boxes, container gardens, loops around trees, vegetable gardens and shrubs

### Features

- Simple to use, as the flexible tubing makes watering pots and container gardens easy
- Clog resistance through built-in filtration and two outlet holes, 180 degrees apart
- Brown tubing complements Rain Bird XF Dripline
- Works with Rain Bird 1/4" barbed Fittings

### Operating Range

- 10 to 40 psi (0.7 to 2.7 bar)
- Flow rate at 30 psi (2.0 bar): 0.8gph (3.0 l/h)
- Required filtration: 200 mesh (75 micron)

### Specifications

- Outside diameter: 0.250" (6 mm)
- Inside diameter: 0.170" (4 mm)
- Wall thickness: 0.040" (1 mm)
- Spacing: 6" or 12" (15.25 cm and 30.5 cm)
- Length: 100' (30.5 m) coils



LDQ-08-06-100

### Models

- LDQ0806100 • LDQ0812100

### Flow Characteristics

Model	Flow at 30 psi (gph)		Spacing (in.)		Coil Length (ft.)	
LDQ0806100	0.8	3.0	6	15.25	100	30.50
LDQ0812100	0.8	3.0	12	30.5	100	30.5

### 1/4" Landscape Dripline Performance

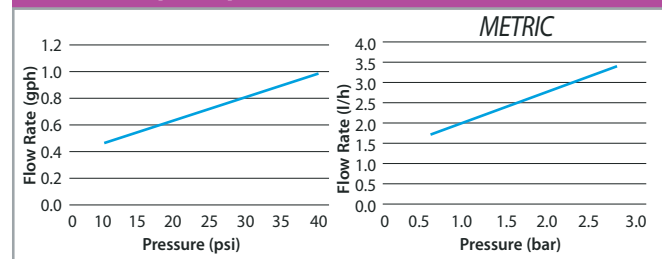

### Maximum Length of Run (Feet)

Emitter Spacing	Maximum Length of Run	Flow per Ft. @ 15 psi
6"	19 feet	1 gph/ft.
12"	33 feet	0.5 gph/ft.

## 1/4" Barb Transfer Fittings

### Features

- Used to connect 1/4" Distribution Tubing (XQ) in different configurations or attach 1/4" tubing to 1/2" or 3/4" tubing
- Newly designed connectors have self-piercing barbs that easily puncture 1/2" or 3/4" tubing
- Stem on fittings allows simple, quick installation using Xeriman™ Tool (XM-TOOL)
- Rugged plastic construction

### Operating Range\*

- Pressure: 0 to 50 psi (0 to 3.5 bar)
- \* with polyethylene tubing

### Models

- XBF1CONN: 1/4" barb connector
- XBF2EL: 1/4" barb x barb elbow
- XBF3TEE: 1/4" barb x barb x barb tee



XBF1CONN



XBF2EL



XBF3TEE

## Subterranean Emitter Box

### Features

- Provides convenient access to subsurface emitter while protecting against vandalism. Ideal for multi-outlet devices (such as Xeri-Bird 8) and Air Vacuum Relief Valve Kit
- New larger body allows more room for components and distribution tubing
- Rugged, UV-resistant thermoplastic construction
- Available with black top

### Dimensions

- Height: 9.0" (22.9 cm)
- Top Diameter: 6.4" (16.3 cm)
- Base Diameter: 9.8" (24.9 cm)

### Model

- SEB 7XB



SEB 7XB

## Galvanized Tie-Down Stake

### Features

- 12-gauge galvanized steel rod comes pre-bent to staple distribution tubing, XF Dripline or XBS Tubing to finished grade
- Notched sides help secure stake in ground
- Sturdy, long-lasting and corrosion-resistant

### Model

- TDS-060



TDS-060

## Tubing Goof Plug

### Features

- Used to plug unwanted holes in tubing
- New design works with Xeriman™ Tool (XM-TOOL) for a quick, easy installation

### Model

- EMA-GPX



EMA-GPX

## Tubing Cutter

### Features

- Re-designed Xerigation® Tubing Cutter allows for easier and cleaner cuts of all low-volume tubing
- Unique design provides two different-sized wells (one for 1/2" - 3/4" tubing and one for 1/4" tubing); giving more leverage so less force is needed to cut any tubing
- Tubing Cutter is lightweight with stainless steel blades. Replacement blades available (PPC-200XBLD)

### Model

- PPC-200X: Tubing cutter
- PPC-200XBLD: Replacement blades

Improved Dual-well Design Allows for Clean Cuts



PPC-200X



## Control Zone Kit Selection Guide



*2-Wire Compatible*

**XCZ-150-PRB-COM**  
FLOW: 15 - 40 gpm

**Commercial High Flow: 15 - 40 gpm**

Page  
152



*2-Wire Compatible*

**XCZ-100-PRB-COM**  
FLOW: 0.3 - 20 gpm



*2-Wire Compatible*

**XCZ-100-PRBR**  
FLOW: 0.3 - 20 gpm



*2-Wire Compatible*

**XCZ-100-PRB-LC**  
FLOW: 0.3 - 20 gpm **UPDATED**

**Commercial Wide Flow: 0.3 - 20 gpm**

Pages  
150 - 151



*2-Wire Compatible*

**XCZPGA-100-PRF** **NEW**  
FLOW: 3 - 15 gpm



**XCZ-100-PRF**  
FLOW: 3 - 15 gpm



**XACZ-100-PRF**  
FLOW: 3 - 15 gpm

**Residential Medium Flow: 3 - 15 gpm**

Pages  
148 - 149



**XCZLF-100-PRF** **NEW**  
FLOW: 0.2 - 10 gpm

**Residential Low Flow:  
Flow: 0.2 - 10 gpm**



**XCZ-075-PRF**  
FLOW: 0.2 - 5 gpm



**XACZ-075-PRF**  
FLOW: 0.2 - 5 gpm

**Residential Low Flow:  
Flow: 0.2 - 5 gpm**

Pages  
147 - 148

### Online Control Zone Kit Selection Guide

Rain Bird Control Zone Kits provide all of the components necessary for on/off control, filtration and pressure regulation of a low-volume irrigation zone, making the kits simple to order and easy to install.

This quick selection tool will help you find the appropriate control zone kit for your application. By answering a few simple questions, the selection guide will provide recommended control zone kits best suited for your application. Simply click on the kit image for detailed information and specifications.

#### Features

- Includes detailed drawings and specifications for each kit
- Available at [www.rainbird.com/CZK](http://www.rainbird.com/CZK)



## Control Zone Kits

Rain Bird Control Zone Kits provide all of the components necessary for on/off control, filtration, and pressure regulation in a single package, making them simple to order and easy to install.

- Most reliable kits, and contain revolutionary products such as the Low Flow Valve and Quick Check Basket Filter
- All kits in every category use the innovative PR Filter which combines the filter and pressure regulator into one unit.

- Rain Bird offers the most complete line of Control Zone Kits, giving contractors and specifiers the flexibility to meet every need from 0.2 to 40 gpm. Choose from:
  - ¾", 1" or 1½" inlet opening
  - Low Flow Valve, Anti-Siphon Valve, DV Valve, or PESB Valve
  - Pressure Regulating RBY Filter, Pressure Regulating Quick Check Basket Filter, or Quick Check Basket Filter

Use the chart below to identify the most appropriate kit or see pages 147 - 152 for specific detailed information on these kits and their individual components. Also available is the interactive Control Zone Kit Pyramid Selection Guide for selection and detailed specification information; found at [www.rainbird.com/CZK](http://www.rainbird.com/CZK)

Control Zone Selection Chart							
Model	Size (Inlet x Outlet)	Flow Range	Valve	2-Wire Compatible	Filter	Outlet Pressure	Comes Assembled
<b>COMMERCIAL HIGH FLOW: 15 – 40 gpm</b>							
XCZ-150-PRB-COM	1½" x 2 @ 1"	15 - 40 gpm	150-PESB	Yes	1" Quick Check PR Basket Filter (2)	40 psi	
<b>COMMERCIAL WIDE FLOW: 0.30 – 20 gpm</b>							
XCZ-100-PRB-COM <sup>1</sup>	1" x 1"	0.3 - 20 gpm	100-PESB	Yes	1" Quick Check PR Basket Filter	40 psi	
XCZ-100-PRBR <sup>1</sup>	1" x 1"	0.3 - 20 gpm	100-PESBR	Yes	1" PR Basket Filter	40 psi	
XCZ-100-PRB-LC <sup>1</sup>	1" x 1"	0.3 - 20 gpm	100-PEB	Yes	1" PR Basket Filter	40 psi	
<b>RESIDENTIAL MEDIUM FLOW: 3 – 15 gpm</b>							
XCZPGA-100-PRF <sup>1</sup>	1" x 1"	3 - 15 gpm	100-PGA	Yes	1" PR RBY Filter	40 psi	
XCZ-100-PRF <sup>1</sup>	1" x 1"	3 - 15 gpm	100-DV	No	1" PR RBY Filter	40 psi	✓
XACZ-100-PRF <sup>1</sup>	1" x 1"	3 - 15 gpm	100-ASVF	No	1" PR RBY Filter	40 psi	
<b>RESIDENTIAL LOW FLOW: 0.2 – 10 gpm</b>							
XCZLF-100-PRF <sup>1</sup>	1" x 1"	0.2 - 10 gpm	LFV-100	No	1" PR RBY Filter	40 psi	✓
XCZ-075-PRF <sup>1</sup>	¾" x ¾"	0.2 - 5 gpm	LFV-075	No	¾" PR RBY Filter	30 psi	✓
XACZ-075-PRF <sup>1</sup>	¾" x ¾"	0.2 - 5 gpm	ASV-LFV-075	No	¾" PR RBY Filter	30 psi	

<sup>1</sup> For Flows below 5gpm Rain Bird recommends use of upstream filtration to prevent debris from collecting below the diaphragm



Combine a Xerigation® Control Zone Kit with a Rain Bird controller product to precisely regulate zone watering times.

## Low Flow Control Zone Kits with PR Filter

- Reliable Control Zone Kits that include the Low Flow Valve, the only valve on the market that can handle low flows (below 3 gpm) without weeping
- Shorter kits with only two components (valve plus pressure-regulating filter) mean that you can fit more Control Zone Kits in a valve box, saving time and money
- These PR Filter kits provide on/off control, filtration, and pressure regulation with fewer components; so there is less chance of leakage at the connections, both at installation and over the life of the system

### Operating Range

- Flow: 0.20 to 10 gpm (0.8 to 37.85 l/m)
- Inlet pressure: 20 to 150 psi (1.4 to 10.3 bar)
- Regulated pressure: 30 psi (2.1 bar)
- Filtration: 200 mesh stainless steel screen (75 micron)

### Models

- XCZ-075-PRF: ¾" Low Flow Valve with ¾" PR RBY Filter (Assembled)  
Flow: 0.2 to 5.0 gpm (0.8 to 18.91 l/m)
- XCZLF-100-PRF: 1" Low Flow Valve with 1" PR RBY Filter (Assembled)  
Flow: 0.2 to 10.0 gpm (0.8 to 37.85 l/m)

### Replacement Screen

- RBY-200SSMX (200 mesh stainless steel screen)

### Minimum Inlet Pressure for 30psi (2.1 bar) outlet pressure

Flow (gpm)	Flow (l/m)	XCZ-075-PRF	
		Pressure (psi)	Pressure (bar)
0.2	0.8	34.4	2.4
1.0	3.8	36.1	2.5
3.0	11.4	38.1	2.6
5.0	18.9	43.4	3.0

### Minimum Inlet Pressure for 40psi (2.8 bar) outlet pressure

Flow (gpm)	Flow (l/m)	XCZLF-100-PRF	
		Pressure (psi)	Pressure (bar)
0.2	0.8	44.4	3.1
1.0	3.8	44.4	3.1
3.0	11.4	45.0	3.1
5.0	18.9	46.2	3.2
10.0	37.9	52.2	3.6



Four Control Zone Kits in a Standard Valve Box

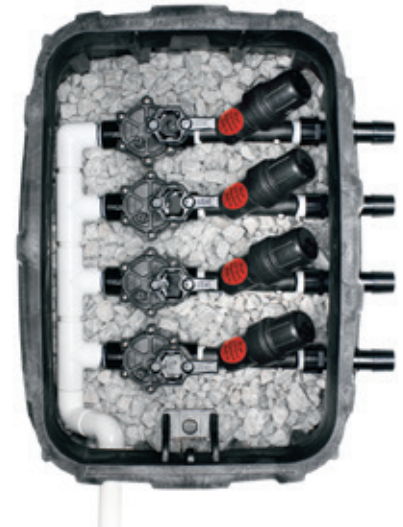

## Low Flow Control Zone Kits with Anti-Siphon Valve and PR Filter

- Reliable Control Zone Kits that include the Low Flow Valve, the only valve on the market that can handle low flows (below 3 gpm) without weeping
- Complete, two-piece Control Zone Kits include the field-proven Low Flow Anti-Siphon Valve that has an atmospheric vacuum breaker for backflow prevention and an IAPMO rating
- These PR Filter kits provide on/off control, filtration, and pressure regulation with only two parts; so there is less chance of leakage at the connections, both at installation and over the life of the system

### Operating Range

- Flow: 0.20 to 5.0 gpm (0.8 to 18.9 l/m)
- Inlet pressure: 20 to 150 psi (1.4 to 10.3 bar)
- Filtration: 200 mesh stainless steel screen (75 micron)
- Regulated pressure: 30 psi (2.1 bar)

### Models

- XACZ-075-PRF: ¾" Low Flow Anti-Siphon Valve with ¾" PR RBY Filter

### Replacement Screen

- RBY-200SSMX (200 mesh stainless steel screen)



## Medium Flow Control Zone Kits with Anti-Siphon Valve and PR Filter

- Complete, two-piece Control Zone Kits include the field-proven ASVF valve which has an atmospheric vacuum breaker for backflow prevention and an IAPMO rating
- These PR Filter kits provide on/off control, filtration, and pressure regulation with only two parts; so there is less chance of leakage at the connections, both at installation and over the life of the system

### Operating Range

- Flow: 3.0 to 15.0 gpm (11.4 to 56.8 l/m)
- Inlet pressure: 20 to 150 psi (1.4 to 10.3 bar)
- Filtration: 200 mesh stainless steel screen (75 micron)
- Regulated pressure: 40 psi (2.8 bar)

### Models

- XACZ-100-PRF: 1" ASVF with 1" PR RBY Filter

### Replacement Screen

- RBY-200SSMX (200 mesh stainless steel screen)



Minimum Inlet Pressure for 30 psi / 2.1 bar Outlet Pressure

Flow gpm	l/m	Inlet Pressure psi	bar
0.2	0.8	37.4	2.6
1.0	3.8	39.1	2.7
3.0	11.4	40.0	2.8
5.0	18.9	49.7	3.4

XACZ-075-PRF

Minimum Inlet Pressure for 40 psi Outlet Pressure

Flow gpm	l/m	Inlet Pressure (psi)	
		psi	bar
3.0	11.4	43.3	3.0
5.0	18.9	44.7	3.1
7.0	26.5	46.2	3.2
9.0	34.1	47.3	3.3
11.0	41.6	50.8	3.5
13.0	49.2	55.4	3.8
15.0	56.8	59.7	4.1

XACZ-100-PRF

## Medium Flow Control Zone Kits with PR Filter

- Reliable Control Zone Kit that includes an extra durable PGA valve
- These PR Filter kits provide on/off control, filtration, and pressure regulation with only two parts; so there is less chance of leakage at the connections, both at installation and over the life of the system
- 2-wire compatible residential Control Zone Kit

### Operating Range

- Flow: 3 to 15 gpm (11.4 to 56.8 l/m)
- Inlet pressure: 20 to 150 psi (1.4 to 10.3 bar)
- Filtration: 200 mesh stainless steel screen (75 micron)
- Regulated pressure: 40 psi (2.8 bar)

### Models

- XCZPGA-100-PRF: 1" PGA Valve with 1" PR Filter

### Replacement Screen

- RBY-200SSMX (200 mesh stainless steel screen)



## Medium Flow Control Zone Kits with PR Filter

- Shorter kits with only two components (valve plus pressure-regulating filter) mean that you can fit more Control Zone Kits in a valve box, saving time and money
- These PR Filter kits provide on/off control, filtration, and pressure regulation with only two parts; so there is less chance of leakage at the connections, both at installation and over the life of the system

### Operating Range

- Flow: 3 to 15 gpm (11.4 to 56.8 l/m)
- Inlet pressure: 20 to 150 psi (1.4 to 10.3 bar)
- Filtration: 200 mesh stainless steel screen (75 micron)
- Regulated pressure: 40 psi (2.8 bar)

### Models

- XCZ-100-PRF: 1" DV Valve with 1" PR Filter (Assembled)\*

\* Available with BSP threads

### Replacement Screen

- RBY-200SSMX (200 mesh stainless steel screen)



### Minimum Inlet Pressure for 40 psi outlet pressure

Flow (gpm)	Inlet Pressure (psi) XCZPGA-100-PRF	Inlet Pressure (psi) XCZ-100-PRF
3.0	45.8	42.9
5.0	47.0	44.1
10.0	50.7	48.5
15.0	57.6	55.5

### Minimum Inlet Pressure for 2.8 bar outlet pressure

Flow (l/m)	Inlet Pressure (bar) XCZPGA-100-PRF	Inlet Pressure (bar) XCZ-100-PRF
11.4	3.2	3.0
18.9	3.2	3.0
37.9	3.5	3.3
56.8	4.0	3.8

## Wide Flow Commercial Control Zone Kit with Pressure Regulating, Basket Filter

UPDATED

- Industry wide flow range between 0.3 and 20 gpm (1.13 to 75.71 l/m) leading enables single SKU purchase for large projects
- Updated with the reliable, flexible and proven PEB valve with the rugged pressure regulating basket filter
- This PR Filter kit provides on/off control, filtration, and pressure regulation with only two parts; so there is less chance of leakage at the connections, both at installation and over the life of the system
- The “No Spill” feature of the basket filter ensures dirt does not fall back into the filter during cleanup operation. The threaded filter top with O-ring makes it easy to remove and clean that stainless steel filter screen

### Operating Range

- Flow: 0.3 to 20 gpm (1.13 to 75.71 l/m)\*
- Inlet Pressure: 15 to 150 psi (1,0 to 10,3 bar)
- Regulating Pressure: 40 psi (2,7 bar)
- Filtration: 200 mesh (75 micron) stainless steel
- Temperature: Up to 150 degree F (66 degree C)

### Model

- XCZ-100-PRB-LC: 1" PEB Valve with 1" Pressure Regulating (40 psi), Basket Filter
- XCZ-100-PRB-MC: 1" PESB Valve with 1" Pressure Regulating (40 psi), Basket Filter

### Replacement Filter Screens

- QKCHK-100M: 100 mesh stainless steel screen, red
- QKCHK-200M: 200 mesh stainless steel screen, white

### Replacement Cap

- BFCAP (Complete cap with body o-ring)

\*For flows below 5gpm Rain Bird recommends use of upstream filtration to prevent debris from collecting below the diaphragm

Minimum Inlet Pressure for 40 psi (2.8 bar) Outlet Pressure			
Flow Rate gpm	l/m	Inlet Pressure	
		psi	bar
0.3	1.14	41.0	2.82
1.0	3.78	41.5	2.86
5.0	18.9	43.0	2.9
10.0	37.9	48.0	3.3
15.0	56.8	56.0	3.8
20.0	75.7	65.0	4.5



XCZ-100-PRB-LC

## Wide Flow Commercial Control Zone Kit with Scrubber Valve & Pressure Regulating, Basket Filter

- Complete kit is the simplest, smallest and most reliable Control Zone Kit for commercial applications between 3 and 20 gpm (11 and 76 l/m)
- Includes the reliable, proven PESB Valve which provides patented scrubbing action, making this kit ideal for commercial dirty water applications
- Includes the Pressure Regulating, Quick-Check Basket Filter that has a clear indicator which goes from green to red, telling you when to clean the filter. This reduces maintenance and takes the guesswork out of cleaning the filter. In addition, the threaded top makes it easy to remove and clean the stainless steel screen
- Basket Filter and Pressure Regulator have been combined for one smaller Pressure Regulating, Quick-Check Basket filter that is 24% smaller than the previous unit

### Operating Range

- Flow: 0.3 to 20.0 gpm (1.13 to 75.7 l/m)\*
- Inlet Pressure: 15 to 150 psi (1,0 to 10,3 bar)
- Regulating Pressure: 40 psi (2,7 bar)
- Filtration: 200 mesh (75 micron) stainless steel
- Temperature: Up to 150° F (66° C)

### Model

- X CZ-100-PRB-COM: 1" Ball Valve with 1" PESB Valve and 1" Pressure Regulating (40 psi), Quick-Check Basket Filter
- X CZ-100-PRBR: 1" PESBR Valve and 1" Pressure Regulating (40psi) Basket Filter

### Replacement Screen

- QKCHK100M (100 mesh stainless steel screen)
- QKCHK200M (200 mesh stainless steel screen)

### Replacement Cap

- QKCHKCAP (Complete cap with body o-ring)

\* For flows below 5gpm Rain Bird recommends use of upstream filtration to prevent debris from collecting below the diaphragm

### Minimum Inlet Pressure for 40 psi Outlet Pressure

Flow (gpm)	Inlet Pressure (psi) X CZ-PRB-100-COM	Inlet Pressure (psi) X CZ-100-PRBR
0.3	41.0	41.0
1.0	41.5	41.5
3.0	42.0	42.0
5.0	44.0	45.0
10.0	47.3	49.0
15.0	53.0	57.0
20.0	62.5	62.5

### Minimum Inlet Pressure for 2.8 bar Outlet Pressure

Flow (l/m)	Inlet Pressure (bar) X CZ-PRB-100-COM	Inlet Pressure (bar) X CZ-100-PRBR
1.136	2.82	2.82
3.78	2.86	2.86
11.4	2.9	2.9
18.9	3.0	3.1
37.9	3.3	3.4
56.8	3.6	3.9
75.7	4.3	4.3



X CZ-100-PRBR



X CZ-100-PRB-COM

## High Flow Commercial Control Zone Kit with 2 Pressure Regulating, Basket Filters

- Highest flow Control Zone Kit on the market for large, commercial drip zones 15.0 to 40.0 gpm (56,8 to 151,4 l/m)
- Includes the reliable, proven 1 ½" PESB Valve which provides patented scrubbing action, making this kit ideal for commercial dirty water applications
- Includes 2 Pressure Regulating, Quick-Check Basket Filter that have a clear indicator which goes from green to red, telling you when to clean the filter. This reduces maintenance and takes the guesswork out of cleaning the filter. In addition, the threaded top makes it easy to remove and clean the stainless steel screen
- Basket Filter and Pressure Regulator have been combined for one smaller Pressure Regulating, Quick-Check Basket filter that is 22% smaller than the previous unit
- Comes partially assembled for convenience and ease of installation

### Operating Range

- Flow: 15.0 to 40.0 gpm (56,8 to 151,4 l/m)
- Inlet Pressure: 20 to 150 psi (1,4 to 10,3 bar)
- Regulating Pressure: 40 psi (2,7 bar)
- Filtration: 200 mesh (75 micron) stainless steel
- Temperature: Up to 150° F (66° C)

### Models

- XCZ-150-PRB-COM: 1 1/2" PESB Valve with two 1" Pressure Regulating (40 psi), Quick-Check Basket Filters

### Replacement Screen

- QKCHK100M (100 mesh stainless steel screen)
- QKCHK200M (200 mesh stainless steel screen)

### Replacement Cap

- QKCHKCAP (Complete cap with body o-ring)

Minimum Inlet Pressure for 40 psi Outlet Pressure	
Flow (gpm)	Inlet Pressure (psi) XCZ-150-PRB-COM
15.0	40.0
20.0	49.0
25.0	50.2
30.0	53.5
35.0	56.1
40.0	60.7

Minimum Inlet Pressure for 2.8 bar Outlet Pressure	
Flow (l/m)	Inlet Pressure (bar) XCZ-150-PRB-COM
56.8	2.8
75.7	3.4
94.7	3.5
113.6	3.7
132.5	3.9
151.4	4.2





## Low Flow Valves

Valves designed exclusively for the low flow rates of a drip irrigation system (0.2 - 10.0 gpm; 0.6 to 37.8 l/m)

### Features

- The only valves in the industry made specifically for drip irrigation systems, making these the only valves that can effectively handle particles at low flow rates – patented design
- These valves contain all of the features of reliable Rain Bird DV valves, coupled with a unique diaphragm design that allows particles to pass through at extremely low flow rates, thereby preventing weeping of the valve
- Allows the filter to be safely placed downstream of the valve since these valves handle all sizes of particles
- Unique “double-knife” diaphragm coupled with ½" diameter seat for flawless operation at low flow rates
- Low Flow Valve is available in ¾" In-line model
- Double-filtered pilot flow design for maximum reliability
- External bleed to manually flush the system of dirt and debris during installation and system start-up
- Internal bleed for spray-free manual operation.

### Operating Range

- Flow: 0.20 to 10.0 gpm (0.6 to 37.8 l/m)
- Pressure: 15 to 150 psi (1.0 to 10.3 bar)

### Electrical Specifications

- 24 VAC 50/60 Hz (cycles/sec) solenoid
- Inrush current: 0.30 (7.2 VA) at 60 Hz
- Holding current: 0.19 A (4.56 VA)

### Models

- LfV-075: ¾" Low Flow DV Valve
- LfV-100\*: 1" Low Flow DV Valve

*\*Available with BSP threads*

### Pressure Loss Characteristics

Flow gpm	LFV-075 psi	LFV-100 psi
0.2	3.0	3.0
1.0	3.2	3.2
2.0	3.3	3.3
4.0	3.6	3.6
6.0	4.2	4.2
8.0	5.1	5.1

### Pressure Loss Characteristics

Flow l/m	LFV-075 bar	LFV-100 bar	METRIC
0.6	0.21	0.21	
3.6	0.22	0.22	
7.8	0.23	0.23	
15.0	0.25	0.25	
22.8	0.28	0.28	
30.0	0.35	0.35	

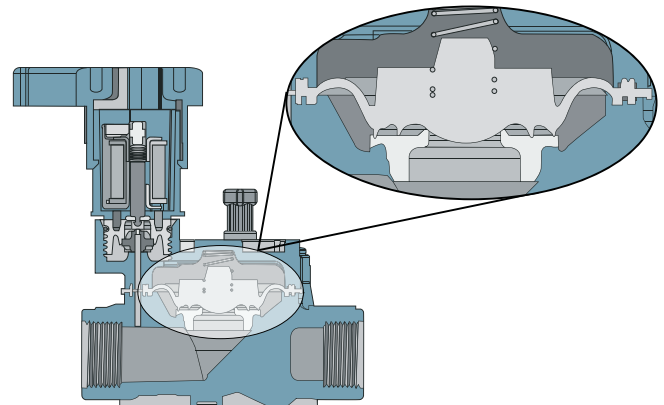

Unique Diaphragm Design



LFV-075

*Note: Also available as part of  
XCZLF-100-PRF (p. 147)*

### Inline RBY Filter

Static filter helps prevent plugging in a drip irrigation system

#### Features

- A simple and reliable filter for low-volume irrigation systems
- Simple to clean, as cap has a sealing O-ring and unthreads to provide access to the stainless steel filter element
- Strong and reliable due to its robust design and glass-filled polypropylene construction
- Male x Male threaded connections for direct connection to valves and pressure regulators
- Replacement stainless steel elements are available in 200 mesh (75 micron)

#### Operating Range

- Flow:
  - ¾" units: 0.20 to 12.0 gpm (0.8 to 45.4 l/m)
  - 1" units: 0.20 to 18.0 gpm (0.8 to 68.1 l/m)
- Pressure: 20 to 150 psi (1.4 to 10.3 bar)
- Filtration: 200 mesh (75 micron)

#### Models

- RBY075MPTX: ¾" Inline RBY Filter with 200 Mesh Screen
- RBY100MPTX: 1" Inline RBY Filter with 200 Mesh Screen\*

#### Replacement screen:

- RBY-200SSMX (200 mesh stainless steel screen)



RBY075MPTX

#### Pressure Loss Characteristics

Flow Rate		RBY075MPTX		RBY100MPTX	
gpm	l/m	psi	bar	psi	bar
1.00	0.8	0.1	0.00	0.1	0.00
3.00	3.8	0.4	0.01	0.3	0.01
5.0	11.4	1.1	0.03	0.5	0.02
7.0	18.9	1.6	0.08	0.8	0.03
9.0	26.5	2.7	0.11	1.4	0.06
12.0	34.1	4.5	0.19	2.2	0.10
14.0	45.4	--	0.31	3.0	0.15
16.0	53.0	--	--	3.8	0.21
18.0	60.6	--	--	4.7	0.26
	68.1	--	--	--	0.32

**Note:** Pressure loss for 200 mesh filter screen

### Pressure-Regulating Filter (RBY)

Unique, compact unit that works with all valves to create a simple, efficient control zone. Combines filtration and pressure regulation in one piece for protection of downstream components in a low-volume irrigation system

#### Features

- Reduces the number of components in a control zone, making it smaller and easier to install. More control zones can fit in one valve box!
- Combination unit comes with 200 mesh (75 micron) stainless steel reduces the number of connections, making installation easier and faster
- Static RBY filter regulates pressure to a nominal 30 or 40 psi (2.0 or 2.8 bar) -PR RBY Filter Cap has sealing O-ring and unthreads to provide access to the filter element for easy cleaning
- 30 or 40 psi pressure regulator is integrated into the filter body
- Robust body and cap are made of glass-filled polypropylene and provide 150 psi (10.3 bar) pressure rating

#### Operating Range

- Flow - ¾" units: 0.20 to 5.0 gpm (0.8 to 18.9 l/m)
  - 1" units: 3.0 to 15.0 gpm (11.4 to 56.8 l/m)
- Inlet pressure: 20 to 150 psi (1.4 to 10.3 bar)
- Regulated pressure: - ¾" units: 30 psi (2.1 bar)
  - 1" units: 40 psi (2.8 bar)

Components of Control Zone Kits Found on pg. 147-157

#### Models

- PRF-075-RBY: ¾" PR RBY Filter
- PRF-100-RBY: 1" PR RBY Filter

#### Replacement Screen

- RBY-200SSMX (200 mesh stainless steel screen)

Stainless Steel Screen



PRF-075-RBY and PRF-100-RBY

#### Pressure Loss Characteristics

Flow		PRF-075-RBY		PRF-100-RBY	
gpm	l/m	psi	bar	psi	bar
0.2	0.8	3.0	0.21	N/A	N/A
1.0	3.8	4.0	0.28	N/A	N/A
3.0	11.4	6.1	0.42	0.8	0.06
5.0	18.9	10.0	0.69	2.0	0.14
8.0	30.3	N/A	N/A	3.8	0.26
10.0	37.9	N/A	N/A	5.2	0.36
15.0	56.8	N/A	N/A	12.0	0.83

**Note:** Pressure loss for 200 mesh filter screen

## Quick-Check Basket Filter

The only commercial-grade filter with a clean/dirty indicator for low-volume irrigation zones

### Features

- Reduces maintenance and labor costs — the indicator tells you when to clean the filter, taking the guesswork out of cleaning the filter
- Provides increased reliability – “No-spill” feature ensures dirt does not fall back into the filter during cleanup operation
- Simplifies installation and maintenance - threaded top with O-ring makes it easy to remove and clean the screen
- Available in 1" model
- Comes pre-assembled with 200 mesh (75 micron) stainless steel screen (other screen sizes available)

### Operating Range

- Flow: 3.0 to 20.0 gpm (11.4 to 75.7 l/m)
- Pressure: 0-150 psi (0 to 10.3 bar)

### Models

- QKCHK-100\*: 1" Basket Filter with 200 mesh stainless steel screen  
*\* Available with BSP threads*

### Pressure Loss Characteristics - QKCHK-100

Flow Rate gpm	l/m	100 mesh screen		200 mesh screen	
		psi	bar	psi	bar
3	11.4	0.1	0.0	0.0	0.0
5	18.9	0.2	0.0	0.0	0.0
7	26.5	0.4	0.0	0.4	0.0
9	34.1	0.7	0.0	0.7	0.0
11	41.6	0.9	0.1	1.1	0.1
14	53.0	1.3	0.1	1.6	0.1
20	75.7	2.9	0.2	3.2	0.2

**Note:** Pressure loss for 200 mesh filter screen

### Replacement Filter Screens

- QKCHK-100M: 100 mesh screen, red
- QKCHK-200M: 200 mesh stainless steel screen, white

### Replacement Cap

- QKCHKAP (Complete cap with body o-ring)

QKCHK-100



## Inline Pressure Regulators

### Features

- Can be installed above or below grade
- Preset outlet pressure: 30 psi (2.0 bar) and 40 psi (2.8 bar)
- ¾" or 1" NPT female-threaded inlet and outlet

### Operating Range

- Flow
  - PSI-L30X-075: 0.20 to 5.0 gpm; 12 to 300 gph (0.8 to 18.9 l/m)
  - PSI-M30X-075, psi-M40X-075: 2.0 to 10.0 gpm; 120 to 600 gph (7.8 to 37.9 l/m)
  - PSI-M40X-100: 2.0 to 20 gpm; 120 to 900 gph (7.8 to 56.8 l/m)
- Inlet Pressure: 10-150 psi (0.7 to 10.3 bar)

### Models

- PSI-L30X-075: ¾" 30 psi (2.1 bar) regulator for low flow (red label)
- PSI-M30X-075: ¾" 30 psi (2.1 bar) regulator for medium flow (yellow label)
- PSI-M40X-075: ¾" 40 psi (2.8 bar) regulator for medium flow (yellow label)
- PSI-M40X-100: Regulator for medium flow



PSI-L30X-075,  
PSI-M40X-075,  
PSI-M40X-100  
PSI-M40-X100

## Retrofit Pressure Regulators

### Features

- Provides convenient 30 psi (2.1 bar) pressure regulation at the riser for any ½" FPT emission device or compression adapter
- Can be installed above or below grade
- Can be used with Xeri-bird™ 8 Multi-Outlet Emission Device (see page 115)

### Operating Range

- Flow: 0.50 to 4.00 gpm; 30 to 240 gph (1.9 to 15.1 l/m)
- Inlet Pressure: 15 to 70 psi (1.0 to 4.8 bar)

### Dimensions

- ½" female-threaded inlet
- Height: 4" (10 cm)

### Model

- PRS-050-30

PRS-050-30



## Pressure Regulating, and Quick-Check Pressure Regulating Basket Filters

The only commercial-grade filter with built in pressure regulator for low-volume irrigation zones. Also available with a clean/dirty indicator.

### Features

- Reduces maintenance and labor costs - 40% larger filter surface than standard filters means less frequent cleaning
- Provides increased reliability – “No Spill” feature ensures dirt does not fall back into the filter during cleanup operation
- Simplifies installation and maintenance – threaded top with O-ring makes it easy to remove and clean that stainless steel filter screen
- Efficient design – combines filtration and pressure regulation in one compact unit with fewer connections
- Available in 1" model
- Comes pre-assembled with 200 mesh (75 micron) stainless steel screen (other screen sizes available)
- Built-in 40 psi (2,7 bar) pressure regulator
- Also available in Light Commercial Control Zone Kits:
  - XCZ-100-PRBR (without Quick-Check feature)
  - XCZ-100-PRB-LC (without Quick-Check feature)
  - XCZ-PRB-100-COM (with Quick-Check)
  - XCZ-PRB-150-COM (with Quick-Check)

### Operating Range

- Flow: 5.0 to 20 gpm (18.9 to 75.7 l/m)
- Inlet Pressure: 15 to 150 psi (1,0 to 10,3 bar)
- Regulating Pressure: 40 psi (2,7 bar)
- Filtration: 200 mesh (75 micron) stainless steel
- Temperature: Up to 150 degree F (66 degree C)

Components  
of Control Zone  
Kits Found on  
pg. 147-157

### Models

- PRB-100: 1" Basket Filter with built-in Pressure Regulator (40 psi ) and 200 mesh (75 micron) stainless steel screen
- PRB-QKCHK-100: 1" Basket Filter with built-in Pressure Regulator (40 psi) and 200 mesh (75 micron) stainless steel screen

### Replacement Filter Screens

- QKCHK-100M: 100 mesh stainless steel screen, red
- QKCHK-200M: 200 mesh stainless steel screen, white

### Replacement Cap

- QKCHKCAP (Complete cap with body o-ring)

Minimum Inlet Pressure for 40 psi (2.8 bar) Outlet Pressure

Flow Rate	Inlet Pressure		Inlet Pressure		
	gpm	l/m	PRB-100 / PRB-QKCHK-100	PRB-QKCHK-200	
		psi	bar	psi	bar
3	11.4	41	2.8	43	2.9
5	18.9	42	2.9	48	3.3
10	37.9	48	3.3	52	3.6
15	56.8	52	3.6	54	3.7
20	75.7	64	4.4	66	4.5



PRB-100

Stainless  
Steel  
Screen



PRB-QKCHK-100



QKCHK-100M



QKCHK-200M

## Large-Capacity Filters

Large-Capacity high flow and low maintenance with a solid build

### Features

- Provides extra large filtration capacity for residential, commercial, and municipal applications
- Durable filters can be easily removed for cleaning, significantly reducing cleaning time
- Disc filters can decompress for easy cleaning
- Auxiliary connection with a threaded cap can be drilled to allow draining or depressurization

### Operating Range

- 1" Model: Maximum flow: Up to 26 gpm (6 m<sup>3</sup>/hr)
  - Filtering surface (disc): 28 in<sup>2</sup> (180 cm<sup>2</sup>)
- 1.5" Models: Maximum flow: Up to 62 gpm (14 m<sup>3</sup>/hr)
  - Filtering surface (disc): 48 in<sup>2</sup> (310 cm<sup>2</sup>)
  - Filtering surface (screen): 42 in<sup>2</sup> (270 cm<sup>2</sup>)
- 2" Models: Maximum flow: Up to 110 gpm (25 m<sup>3</sup>/hr)
  - Filtering surface (disc): 81 in<sup>2</sup> (525 cm<sup>2</sup>)
  - Filtering surface (screen): 75 in<sup>2</sup> (485 cm<sup>2</sup>)
- Maximum Pressure: 116 psi (8 bar)
- Maximum Temperature: Up to 140° F (60° C)

### Models

- LCRBY100D - 1" Large-Capacity Disc Filter
- LCRBY150S - 1.5" Large-Capacity Screen Filter
- LCRBY150D - 1.5" Large-Capacity Disc Filter
- LCRBY200S - 2" Large-Capacity Screen Filter
- LCRBY200D - 2" Large-Capacity Disc Filter

### Specifications

- Inlet / Outlet Size:
  - 1" Models: 1" NPT
  - 1.5" Models: 1.5" NPT
  - 2" Models: 2" NPT

### Filtration

- Stainless Steel Screen Filter: 120 Mesh (130 Micron)\*
- Plastic Filter Discs: 120 Mesh (130 Micron)

\* Screen not available in 1" model

NEW



LCRBY200D



Disc & Screen Filters

### Pressure Loss Characteristics - DISC FILTER

Flow Rate gpm / l/m	1" Filter		1.5" Filter		2" Filter		
	psi	bar	psi	bar	psi	bar	
5	18.93	0.60	0.04	0.08	0.01	0.10	0.01
11	41.67	1.16	0.08	0.18	0.01	0.10	0.01
22	83.33	2.61	0.18	0.40	0.03	0.10	0.01
33	125.0	4.35	0.30	0.73	0.05	0.24	0.02
44	166.67	—	—	1.05	0.07	0.40	0.03
55	208.33	—	—	1.50	0.10	0.60	0.04
66	250.00	—	—	2.18	0.15	0.82	0.06
77	291.67	—	—	3.10	0.21	1.10	0.08
88	333.33	—	—	3.95	0.27	1.60	0.11
99	375.00	—	—	—	—	2.03	0.14
110	416.67	—	—	—	—	2.47	0.17

### Pressure Loss Characteristics - SCREEN FILTER

Flow Rate gpm / l/m	1" Filter		1.5" Filter		2" Filter		
	psi	bar	psi	bar	psi	bar	
5	18.93	0.80	0.06	0.00	0.00	0.00	0.00
11	41.67	1.74	0.12	0.00	0.00	0.00	0.00
22	83.33	2.90	0.20	0.50	0.03	0.20	0.01
33	125.0	4.06	0.28	0.95	0.07	0.25	0.02
44	166.67	—	—	1.45	0.10	0.44	0.03
55	208.33	—	—	1.89	0.13	0.60	0.04
66	250.00	—	—	2.32	0.16	0.87	0.06
77	291.67	—	—	2.76	0.19	1.16	0.08
88	333.33	—	—	3.19	0.22	1.45	0.10
99	375.00	—	—	—	—	1.89	0.13
110	416.67	—	—	—	—	2.32	0.16

Note: Body dimensions are available on the Rain Bird website.

Note: Filter should be installed downstream of the valve, to prevent the filter from being under constant pressure.

### Spray-to-Drip Retrofit Kit

Simple kit that easily converts a conventional spray zone to a low-volume irrigation zone

#### Features

- Permits convenient conversion to drip tubing when used with barbed adapter
- Provides 30 psi (2,0 Bars) pressure regulation and a 200-mesh (75 micron) screen that is easily accessible
- Supports flow rates of 0.5 to 6 gpm
- Internal assembly drops into any 1804, 1806, or 1812 spray head body to easily retrofit existing system to Xerigation® products
- Comes with 1 low profile Barb Tee and 1 Elbow Fitting
- Includes (1) ½" FPT x Elbow Fitting and (1) ½" FPT x Tee Fitting for easy connection to drip tubing

#### Operating Range

- Flow: 0.5 to 6 gpm (0.11 to 1.36 l/m)
- Inlet pressure: 15 to 70 psi (1.0 to 4.8 bar)
- Regulated pressure: 30 psi (2.1 bar)
- Filtration: 200 mesh (75 micron)

#### Model

- 1800-RETRO

#### Dimensions

- ½" (15/21) female-threaded inlet
- ½" (15/21) male-threaded swivel outlet
- Width:
  - Cap: 2.25" (5.70 cm)
  - Body: 1.5" (3.80cm)

#### Replacement Screen

- RBY-200SSMX (200 mesh stainless steel screen)



**Model# 1800XC**  
Can be used to cap off unused Rain Bird 1800 Series spray bodies. (Sold separately)



**Model# XCHPS**  
Can be used to cap off unused Hunter Spray bodies. (Sold separately)



**Model# XCT570**  
Can be used to cap off unused Toro Spray bodies. (Sold separately)

#### Spray-to-Drip Conversion Steps



## Landscape Drip Application Guide

A Practical Guide for Designing and Installing Drip Irrigation Systems. This helpful 68 page guide contains a wealth of useful information to help irrigation professionals save water with efficient drip irrigation systems (English: D39634C, Spanish: D40903)



Landscape Drip Application Guide

## XF Series Dripline Design, Installation and Maintenance Guide

This guide covers the basics of design, installation, and maintenance for Rain Bird's XF Series Dripline including XFD, XFS Subsurface and XFCV with Heavy Duty Check Valve. Included are design steps, technical data, installation layouts and design details to assist in the design of the more common dripline applications (D40024B)



XF Series Dripline Design, Installation and Maintenance Guide

## Landscape Drip Conversion Guide

This guide shows you the easiest and fastest way to convert a traditional spray zone into a water-efficient low volume irrigation zone. Includes step by step instructions for installing spray-to-drip retrofit kits, along with typical applications for converting narrow planting beds near a structure (D40904)



Landscape Drip Conversion Guide

## Extra Durable Drip System Design Guide

Rain Bird's Extra Durable Drip System should be considered for high impact commercial sites where durability, longevity, ease of maintenance and minimal plant failure rate are the top priorities (D40887)



Extra Durable Drip System Design Guide

# Pumps & Filtration

Introduction

Spray Boilies

Spray Nozzles

Rotors

Valves

Controllers

Central Controls

Landscape Drip

Pumps & Filtration

Drainage Products

Resources



## Water Saving Water Saving Tips

- Newer high-efficiency motors are able to convert a higher percentage of their electric input to useful mechanical work resulting in energy and cost savings.
- Rain Bird Variable Frequency Drive (VFD) pump stations save energy while delivering the water pressure necessary to ensure maximum water use efficiency.
- Rain Bird designs pump stations specifically for the application, ensuring the pump runs at maximum efficiency. Delivering the right pressure as demanded by the system ensures your irrigation system is efficient and effective. For assistance call 520-806-5620 or email [pumps@rainbird.com](mailto:pumps@rainbird.com).



## CLP Series

NEW

Compact Low Profile 5HP VFD Pump Station  
5 HP Boost Model; Up to 53 psi boost; Up to 120 gpm  
5 HP Suction Lift Model; Up to 65 psi; Up to 140 gpm  
7.5HP and 10HP CLP Pump Stations available by custom order. For assistance call 520-806-5620 or email pumps@rainbird.com

Rain Bird's CLP Series pump station is designed for boost and flooded suction-lift applications. The CLP Series is a complete pump package that is simple to install and operate. It includes a professional-grade pump, a marine-grade aluminum enclosure, highest quality pump protection, and optional mounting for a Rain Bird controller. Home owner associations, small sports fields, schools, parks, and small agricultural projects are ideal applications. The CLP Series compact design, durable centrifugal boost pump, and ease of installation, make this a perfect solution for applications with flows up to 120 gpm with the Boost model, 140 gpm with the Suction Lift model. With this complete solution there is no need to deal with the hassle of stick building a pump station with non-compatible parts and a makeshift enclosure. Only Rain Bird provides a totally integrated irrigation solution with UL listed components and a one year warranty that dependably deliver healthy, beautiful landscapes, saving time and minimizing maintenance.

### At-A-Glance Description

- Variable Frequency Drive (VFD)
- Pump Start Relay included
- Aluminum Deck and Enclosure
- Stainless Steel Piping
- Isolation Valve for maintenance and priming
- Manual Switch provides user full control and override capabilities
- 2" – Discharge, 2" Intake NPT (Boost), 2 1/2" Suction Port NPT (Suction Lift)
- Mounting options for Rain Bird Controllers

### Features

- Plumbing Configurations
  - Inlet and discharge piping on opposite sides of the enclosure (as shown)
  - 3/4" and 2" Priming Ports Included
- Mechanical Features
  - Isolation valve
  - Liquid filled pressure gauge
  - Rugged centrifugal pump (Suction Lift model is self-priming)

### Enclosures / External Connections

- Marine grade aluminum enclosure and deck
- Stainless Steel piping
- Fused main power disconnect
- Pump Control
  - Runs based on signal from irrigation controller, or from optional Flow Start Switch (Boost model only)
  - 24VAC Pump start relay included. Other voltages available as an accessory.
  - 130 °F Temperature cutout switch

- Electrical Features
  - Incoming power: Single or three phase 208V, 220V, 230V AC
  - TEFC Motor (Boost Model), ODP Motor (Suction Lift Model)
  - UL listed components
- Energy efficient – Variable Frequency Drive (VFD) maintains constant pressure at varying flow demand.
  - Stainless steel pressure transducer
  - Red light for VFD alarms
  - Green pump running light
  - Pipe fill mode reducing pressure surge at pump start up
  - Programmable override pump speed
  - Loss of prime and pipe break alarm
  - Dead head shut down
  - Transducer loss shut down
- Back panel for mounting Rain Bird controllers
  - Pre-drilled for ESP-Me, ESP-LXMe, and ESP-LXD Series Controllers. (Rain Bird controller purchased separately)
- Separate independent power feed required to power controller.
  - Mounted inside or outside aluminum enclosure

### Accessories

- Surge Suppression Kit
  - Single Phase (208-230 VAC) p/n CLPSES1P
  - Three Phase (208-230 VAC) p/n CLPSES3P
- Pump Start Relay
  - 6VDC p/n CLPPSR06DC
  - 12VDC p/n CLPPSR12DC
- Boost Accessories (Boost Model Only)
  - Flow Start Kit p/n CLPBSTSW
- Suction Lift Accessories (Suction Lift Model only)
  - Foot valve – 4" Vertical Flanged p/n CLPFTVLV4VF

### Models

- CLP05VHASC1: CLP Pump Station – Suction-Lift
- CLP05VBASC1: CLP Pump Station – Boost

CLP Series  
(Suction Lift shown)



## Rain Bird® LC Series

¾ to 3 hp; Up to 60 psi (4.1 bar); Up to 115 gpm (26.1 m³/h)

### Features

- Revolutionary complete pump package that includes a professional-grade pump, the highest quality pump protection and simple to install and operate fixtures all housed in a unique enclosure designed specifically for a pump
- Heavy duty pump available in ¾, 1, 1½, 2, and 3 hp offers brass impellers, cast iron housing & stainless steel bolts & ports for pressure, temperature probe & priming
- PSRPT for Shut-down protection. Provides protection if pump experiences loss of pressure or high temperature situations. The PSRPT is housed in a powder coated steel enclosure
- Aesthetically pleasing powder coated enclosure. Provides safe and vandal proof encasement of pump and controls
- Clam shell powder coated steel enclosure. Offers full accessibility to pump and electrical controls
- Quick disconnecting coupling on discharge and suction provides simple on-off connections to speed the hook-up and winterization processes
- Cooling louvres provide ample air to prevent motor and pump from overheating
- 1.5" PVC adapter and pan drain, discharge line through bottom of enclosure insures against theft
- Discharge option through bottom of enclosure or side of enclosure
- Quick disconnecting piggy-tail power cord assures at-pump safety
- 230 volt main power plug
- Padlock ring for security

### Electrical Power Specification

- 60Hz, 1-phase power: 208V, 230V

### Applications

- Suction Lift or Boost
- Potable or Reclaimed Water Supply
- Residential, Light Commercial, Parks, or Recreational

### Models

- LC750: LC Series - 3/4 hp, 1 ph, pump
- LC1000: LC Series - 1 hp, 1 ph, pump
- LC1500: LC Series - 1.5 hp, 1 ph, pump
- LC2000: LC Series - 2 hp, 1 ph, pump
- LC3000: LC Series - 3 hp, 1 ph, pump

### Capacity US gpm based on 5ft. Suction Lift

HP	Discharge psi									
	20	25	30	35	40	45	50	55	60	
1	73	65	57	47	35	18	-	-	-	
1.5	75	70	68	60	48	35	-	-	-	
2	102	98	92	82	74	61	52	40	-	
3	115	114	112	105	100	88	72	56	30	

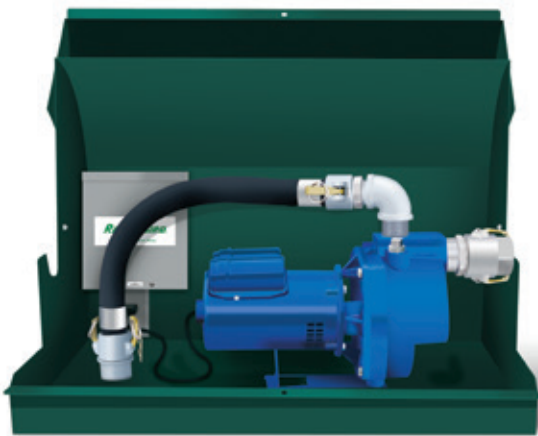

LC Series

### LC Series Pump Performance Curves

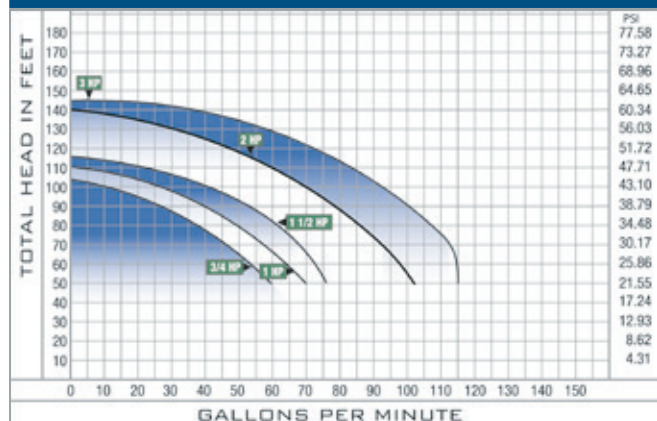

## Low Profile Pump Stations – LP Series

Rain Bird's LP Series Horizontal End Suction and Vertical multistage pump stations are designed for small to midsize boost, flooded suction and suction lift applications such as city parks and buildings, sports fields, commercial buildings, small home owner's associations and large residential sites. Its low profile design, durable centrifugal or vertical multistage pump configuration, and choice of options make it an ideal choice for Turf irrigation applications.

### Standard Features

- Cost effective – Standardized VFD driven pump system in enclosure delivers high performance with minimum investment
- Low Profile – Compact aluminum enclosure with powder coated skid and piping
- Energy efficient – Variable Frequency Drive (VFD) maintains constant pressure at varying flow demand
- Reliability – Simple, standard design, easy installation and maintenance
- Mechanical Features
  - Inlet Butterfly Isolation Valve
  - Discharge Butterfly Isolation Valve
  - Silent Check Valve
- Enclosures / External Connections
  - Marine Grade Aluminum Enclosure
  - Polyester Powder-Coated Steel Deck and Piping
  - Thermostat and Fan on Mechanical Enclosure
- Pump Control
  - Pump Start Relay
  - VFD - Variable Frequency Drive for Control of Pressure
- Display
  - Monochrome Touch Screen Display
  - Optional Color Touch Screen Display with Remote Communication Capability

### Optional Features and Accessories

Visit: [www.rainbird.com/landscape/products/pumps](http://www.rainbird.com/landscape/products/pumps)

### Models

- **Horizontal End Suction - LP Series**
  - 5 to 10 HP; Up to 100 psi (6.9 bar); Up to 200 gpm (12.6 lps, 45.4 m<sup>3</sup>/h)
- **Vertical Multistage - LP Series**
  - 1 to 7.5 HP; Up to 120 psi (8.3 bar); Up to 0 gpm (5.7 lps, 20.4 m<sup>3</sup>/h)

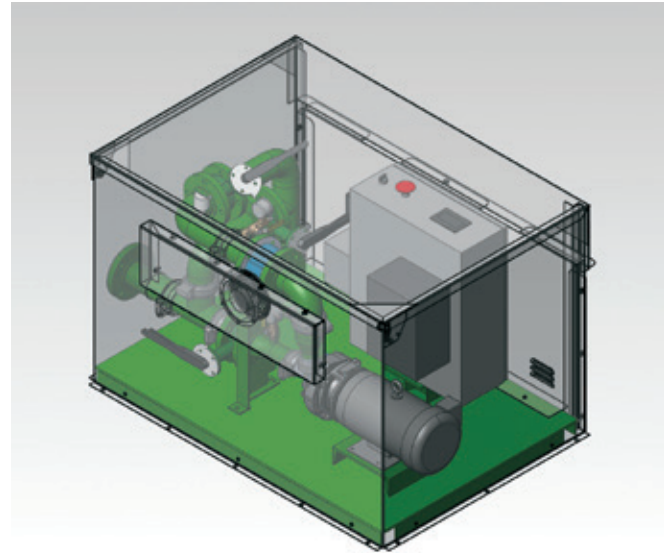

**Horizontal End Suction - LP Series Shown**  
5 to 10 HP; Up to 100 psi (6.9 bar);  
Up to 200 gpm (12.6 lps, 45.4 m<sup>3</sup>/h)

LP Series – Horizontal End Suction - 1 Pump – Aluminum Enclosure			
Motor Size	5 HP	7.5 HP	10 HP
Pump Type	Horizontal End Suction		
Power Requirement	480/60/3 V/HZ/PH		
	208-230/60/3 V/HZ/PH		
	208-230/60/1 V/HZ/PH		
Inlet Pressure Requirement	Suction Lift or Boost Applications		
Outlet Pressure	Up to 100 psi (6.9 bar) <sup>(1)</sup>		
Outlet Flow	Up to 200 gpm (12.6 lps, 45.4 m <sup>3</sup> /h) <sup>(1)</sup>		
Concrete Slab Dimensions (min)	65" x 49" (165 cm x 125 cm)		
Platform Skid Dimensions (min)	53" x 39.75" (135 cm x 101 cm)		
Inlet / Discharge Size	2" Flange Fitting (adapter)	3" Flange Fitting	4" Flange Fitting (adapter)
Cabinet Height (from slab)	35" (89 cm)		

LP Series – Vertical Multistage – 1 Pump – Aluminum Enclosure					
Motor Size	1 HP	1.5 HP	2 HP	5 HP	7.5 HP
Pump Type	Vertical Multistage				
Power Requirement	480/60/3 V/HZ/PH				
	208-230/60/3 V/HZ/PH				
	208-230/60/1 V/HZ/PH				
Inlet Pressure Requirement	Suction Lift or Boost Applications				
Outlet Pressure	Up to 120 psi (8.3 bar) <sup>(1)</sup>				
Outlet Flow	Up to 90 gpm (5.7 lps, 20.4 m <sup>3</sup> /h) <sup>(1)</sup>				
Concrete Slab Dimensions (min)	65" x 49" (165 cm x 125 cm)				
Platform Skid Dimensions (min)	53" x 39 3/4" (135 cm x 101 cm)				
Inlet / Discharge Size	2" flange fitting standard - 3" and 4" adapters available				
Cabinet Height (from slab)	35" (89 cm) or 47" (107 cm)				

(1) Refer to pump performance curves, provided upon request from [pumps@rainbird.com](mailto:pumps@rainbird.com)

### Low to Medium Flow Pump Stations – D-Series

Rain Bird's single pump, Vertical Multi-Stage and Horizontal End Suction stations in powder-coated green enclosures are designed for small to midsize boost, flooded suction and suction lift applications such as city parks and buildings, sports fields, commercial buildings, small home owner's associations and large residential sites. Its small footprint, durable centrifugal or multistage pump configuration, and choice of options make it an ideal choice for Turf irrigation applications.

#### Standard Features

- Reliability – Integrated Plug-n-Pump provide single source responsibility for the entire pumping system insuring trouble-free installation and operation
- Energy efficient – Variable Frequency Drive (VFD) maintains constant pressure at varying flow demand
- Inlet and discharge isolation valves for easier mechanical serviceability
- Easy Start-up – All stations are water-tested at the factory prior to shipment.
- Mechanical Features
  - Inlet Butterfly Isolation Valve
  - Discharge Butterfly Isolation Valve
  - Silent Check Valve
- Pressure / Flow
  - Stainless Steel Pressure Transducer
  - Flow Switch
- Enclosures / External Connections
  - Polyester Powder Coated Steel Enclosure
  - Polyester Powder-Coated Steel Deck and Piping
  - Re-Prime Piping (Suction Lift only)
  - Thermostat and Fan on Mechanical Enclosure
- Pump Control
  - Pump Start Relay
  - VFD - Variable Frequency Drive for Control of Pressure
- Display
  - Monochrome Touch Screen Display
  - Optional Color Touch Screen Display with Remote Communication Capability

#### Optional Features and Accessories

Visit: [www.rainbird.com/landscape/products/pumps](http://www.rainbird.com/landscape/products/pumps)

#### Models

- **Horizontal End Suction - 1 Pump - D Series**
  - 5 to 20 HP; Up to 130 psi (9.0 bar); Up to 180 gpm (11.4 lps, 40.9 m<sup>3</sup>/h)
- **Vertical Multistage – 1 Pump – D Series**
  - 3 to 15 HP; Up to 120 psi (8.3 bar); Up to 200 gpm (12.6 lps, 45.4 m<sup>3</sup>/h)

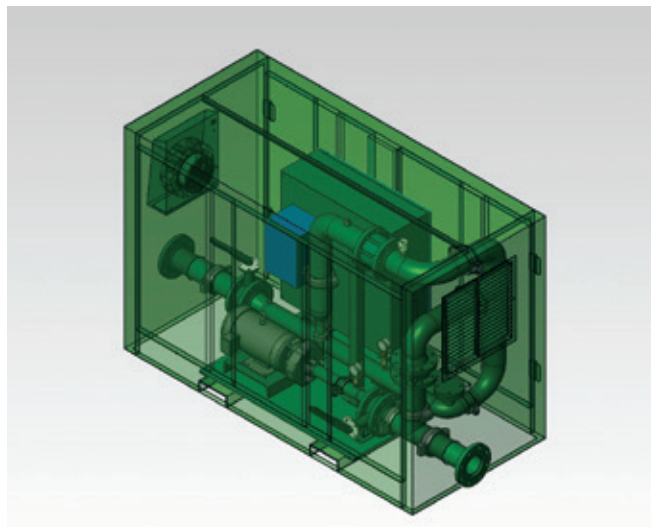

**Horizontal End Suction - 1 Pump - D Series shown**  
5 to 20 HP; Up to 130 psi (9.0 bar);  
Up to 350 gpm (22.1 lps, 79.5 m<sup>3</sup>/h)

#### D-Series – Horizontal End Suction – 1 Pump – Green Enclosure

Motor Size	5 HP	7 ½ HP	10 HP	15 HP	20 HP
Pump Type	Horizontal End Suction				
Power Requirement	480/60/3 V/HZ/PH				
	208-230/60/3 V/HZ/PH				
	230/60/1 V/HZ/PH		208/60/1 V/HZ/PH		
Inlet Pressure Requirement	Suction Lift (up to 3 ft. lift), or Boost Applications				
Outlet Pressure	Up to 130 psi (9.0 bar) <sup>(1)</sup>				
Outlet Flow	Up to 350 gpm (22.1 lps, 79.5 m <sup>3</sup> /h) <sup>(1)</sup>				
Concrete Slab Dimensions (min)	90" x 48" (229 cm x 122 cm)				
Platform Skid Dimensions (min)	78" x 36" (198 cm x 91 cm)				
Inlet / Discharge Size	4" standard - 2", 3" and 6" adapters are external accessories				
Cabinet Height (from slab)	52" (132 cm) or 64" (163 cm)				

#### D-Series – Vertical Multistage – 1 Pump – Green Enclosure

Motor Size	3 HP	5 HP	7 ½ HP	10 HP	15 HP
Pump Type	Vertical Multi-Stage				
Power Requirement	480/60/3 V/HZ/PH				
	208-230/60/3 V/HZ/PH				
	208-230/60/1 V/HZ/PH				
Inlet Pressure Requirement	Suction Lift or Boost Applications				
Outlet Pressure	Up to 120 psi (8.3 bar) <sup>(1)</sup>				
Outlet Flow	Up to 180 gpm (11.4 lps, 40.9 m <sup>3</sup> /h) <sup>(1)</sup>				
Concrete Slab Dimensions (min)	90" x 48" (229 cm x 122 cm)				
Platform Skid Dimensions (min)	78" x 36" (198 cm x 91 cm)				
Inlet / Discharge Size	4" Standard - 2", 3", and 6" adapters available				
Cabinet Height (from slab)	52" (132 cm) or 64" (163 cm)				

<sup>(1)</sup> Refer to pump performance curves, provided upon request from [pumps@rainbird.com](mailto:pumps@rainbird.com)

## Medium Flow Pump Station

Rain Bird's single pump, Vertical Multi-Stage Enhanced station in a compact enclosure is designed for medium-flow boost, flooded suction and suction lift applications, such as; parks, sports complexes, golf courses, turf farms and other agricultural projects. Its compact design, durable centrifugal pump configuration, choice of options and enclosures make it an ideal choice for Turf irrigation applications with flows up to 500 gpm (31.5 lps, 114 m<sup>3</sup>/h).

### Standard Features

- Entry Level through High Performance
- Control Package – With either a cost-effective monochrome touch-panel display or high resolution color touch-panel display for improved user interfaced and remote monitoring via VNC (Virtual Network Computing)
- Energy efficient – Variable Frequency Drive (VFD) maintains constant pressure at varying flow demand
- Enhanced Serviceability – Modern electrical design utilizing industrial breaker motor protection instead of fuses. Industrial circuit breakers are quickly reset and designed for an extended service life
- Inlet and discharge isolation valves for easier mechanical serviceability
- Plumbing Configurations
  - Inlet and Discharge Piping on same side of the enclosure (as shown)
- Mechanical Features
  - Inlet Butterfly Isolation Valve
  - Discharge Butterfly Isolation Valve
  - Pump Isolation Valve
  - Silent Check Valve
- Pressure / Flow
  - Stainless Steel Pressure Transducer
  - Flow Switch
- Enclosures / External Connections
  - Marine Grade Aluminum Enclosure
  - Polyester Powder-Coated Steel Deck and Piping
  - Thermostat and Fan on Mechanical Enclosure

### Optional Features

Visit: [www.rainbird.com/landscape/products/pumps](http://www.rainbird.com/landscape/products/pumps)

### Models

- **Vertical Multi-Stage – 1 Pump Enhanced – Aluminum Enclosure**
  - 5 to 50 HP; Up to 150 psi (10.3 bar); Up to 500 gpm (31.5 lps, 114 m<sup>3</sup>/h)

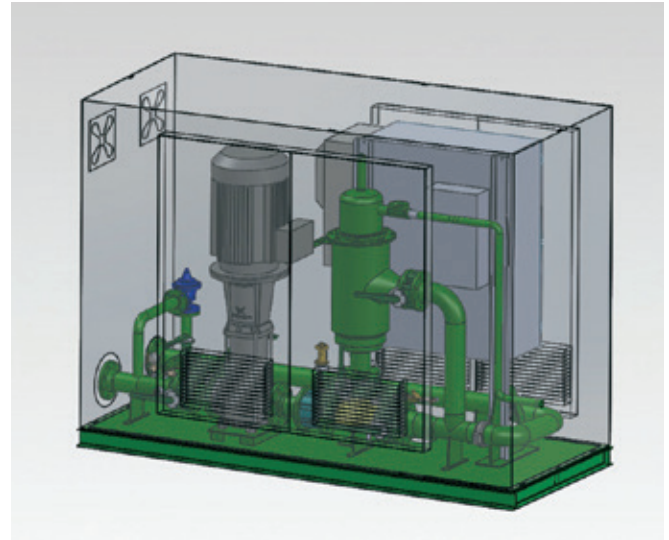

**Vertical Multi-Stage – 1 Pump Enhanced – Aluminum Enclosure shown**  
5 to 50 HP; Up to 150 psi (10.3 bar);  
Up to 500 gpm (31.5 lps, 114 m<sup>3</sup>/h)

Vertical Multi-Stage – 1 Pump Enhanced – Aluminum Enclosure										
Motor Size	5 HP	7.5 HP	10 HP	15 HP	20 HP	20 HP	25 HP	30 HP	40 HP	50 HP
Pump Type	Vertical Multi-Stage									
Power Requirement (Other power configurations available upon request)	208-230/1/60 V/PH/HZ									
	208-230/3/60 V/PH/HZ									
	480/3/60 V/PH/HZ									
	575/3/60 V/PH/HZ									
Inlet Pressure Requirement	Suction Lift or Boost Applications									
Outlet Pressure	Up to 150 psi (10.3 bar) <sup>(1)</sup>									
Outlet Flow	Up to 500 gpm (31.5 lps, 114 m <sup>3</sup> /h) <sup>(1)</sup>									
Concrete Slab Dimensions (min)	10' 3" x 4' 9" (312.4 cm x 145 cm)									
Platform Skid Dimensions (min)	9' 3" x 3' 9" (281 cm x 114.3 cm)									
Inlet / Discharge Size	4" Flanges Standard, 6" Inlet Flange (Suction Lift), 3", 4", 6", 8" Adapters Available									

(1) Refer to pump performance curves, provided upon request from [pumps@rainbird.com](mailto:pumps@rainbird.com)

### Main Irrigation Pump Stations

Flows Up to 5000 GPM

Reliable Variable Frequency Drive Pump Stations designed to serve as the main irrigation pump station for golf courses and large commercial sites. Rain Bird's Pump Station Platforms are designed for both new construction projects and renovation projects

#### Available in the following configurations:

- Vertical Turbine Pump Stations for Wet-well Applications
- Horizontal End Suction for Flooded Suction and Pressure Boosting Applications
- Vertical Multistage Pumps for Flooded Suction, Suction Lift, and Pressure Boosting Applications

#### Benefits:

- Enhanced Serviceability: Modern electrical design utilizing industrial breaker motor protection instead of time-wasting fuses. Industrial circuit breakers are quickly reset and designed for an extended service life
- Reduced Downtime: Industrial circuit breakers are good for thousands of trips
- Easy Operator Training: Multi-language color touch-screen that is easy to learn
- Superior Corrosion Resistance; Choice of Polyester Powder Coated or Marine Grade Aluminum deck for the highest level of corrosion resistance. Less corrosion equals longer pipe, skid, and manifold life, reducing cost
- No-Hassle Buying: Get everything you need for your irrigation system construction or renovation from the only manufacturer dedicated to irrigation for over seven decades
- Real-Time Communication: The pump station communications in real-time with the central, allowing the central to make immediate decisions to maximize the efficiency of the entire irrigations systems

#### Electrical Power Specifications:

- 60 Hz, 3-Phase Power: 208V - 230V (up to 60HP per pump), 460V, 575V
- 50 Hz, 3-Phase Power: 380V, 415V
- Other power configurations available upon request

#### Options:

- Air Conditioned Electrical Panel Cooling System
- Enclosures: Aluminum, Painted Steel (Government Specified Colors)
- Fertigation Systems
- Filtration: Backwashing Screen Filters and Suction Scan Filters (Hydraulic or Electric)
- Heater, Skid Mounted 5KW
- Intake Box Screen with 3 Stainless Steel Screens
- Intermediate Pump, 10-25HP
- Lake Level Control: Float Switch and Ultrasonic
- Magnetic Flow Meter
- Modem, Radio, Hard-wired or Cellular Gateway connection
- Power Zones: 3, 5, or 10KVA
- Premium Efficient Motors
- VFD per pump
- Wye Strainer with Auto Back-flush
- Z Discharge Pipe



### Pump Manager with SmartPump™

- Combine a Rain Bird Pump Station and central control software to fully integrate pump station operation with your central control. This combination allows the pump station and central control to respond to changes in the system and irrigation immediately, providing the highest level of efficiency
- Smart Pump™ matches the irrigation system operation with the real capacity of the pump station, shortening the water window by an average of 20 percent and decreasing energy consumption. In addition, Smart Pump alerts the superintendent in real time of irrigation and pump station problems via cell phone text messaging. When an issue occurs such as an irrigation pipe break, the system verifies the break, shuts down the system and notifies the superintendent. Other systems cannot respond in a timely manner and can lose an hour of irrigation time trying to recover from a system fault



#### Need Help Specifying a Pump?

- Email [pumps@rainbird.com](mailto:pumps@rainbird.com) or call 520-806-5620 for assistance with quotes and specifications

## Pump Start Relays

For Optimum Pump Performance and Protection

Rain Bird Pump Start Relays (PSRs) provide worry free performance for your irrigation system and are compatible with Rain Bird and other reliable irrigation controllers.

### Dual Voltage Pump Start Relay Features

- Works with a lawn controller's start/stop command to facilitate the electrical path from the breaker box to the pump motor
- Provides "pilot duty" operation for all types of electrically driven pump equipment with available coil voltages of 24, 110 and 220 VAC
- 40 AMP certified relay
- Quick connect terminals with wire nuts
- Grounding provision
- Compatible with 24 VAC timed lawn controllers
- Compatible with 110 or 220 VAC 3/4 HP thru 5 HP\* single phase pumps
- Grey "baked-on" powder coating, for long life in difficult environments
- UL Listed as "Enclosed Industrial Control Panels" and backed by a one-year warranty
- Housed in compact NEMA3R weather-tight enclosures
- Not recommended for use with 2-wire controller/decoder systems

### Model

- PSR110220

### 2-Wire Pump Start Relay Features

- Works with a lawn controller's start/stop command to facilitate the electrical path from the breaker box to the pump motor
- Provides "pilot duty" operation for all types of electrically driven pump equipment with available coil voltages of 24, 110 or 220 VAC
- 40 AMP certified relay
- Quick connect terminals with wire nuts
- Grounding provision
- Compatible with 24 VAC timed lawn controllers
- Compatible with 110 or 220 VAC 3/4 HP thru 5 HP\* single phase pumps
- Grey "baked-on" powder coating, for long life in difficult environments
- UL Listed as "Enclosed Industrial Control Panels" and backed by a one-year warranty
- Housed in compact NEMA3R weather-tight enclosures
- Includes an additional ice cube relay for 2-wire controller/decoder systems

### Models

- PSR1101C or PSR2201C

\* when thermal protection is present

Pump Start Relays Specifications			
Model	Line Voltage	Coil Voltage	hp
PSR1101C	110	24	3/4 through 2*
PSR2201C	220	24	3/4 through 5*
PSR110220	110 or 220	24	3/4 through 5*

\* National electrical code (nec) states all motors will be thermally protected from excessive "amperage draw." Most motors under 2 hp are supplied with thermal protection from the motor manufacturer. For motors over 2 hp, code-compliant PSRB pump protection is recommended.

NOTE: Circuit breakers are never classified as motor protection

NOTE: Check with your local health department for regulations and requirements for backflow prevention.



PSR110220



PSR1101C  
or  
PSR2201C

## G-Series Hydraulic Suction Scanning Screen Filter

Economy and Value with Lower Backwash Volumes

### Irrigation Uses

Self-cleaning line powered hydraulic water filters for turf, landscape, agriculture, greenhouse and nursery applications.

### Features

- Flow rates: 25 – 1750 gpm
- Max Temperature: 210° F
- PVC/Mesh screen standard
  - Sintered and wedgewire screens available upon request
- Standard screen opening: 120µ
  - Optional: 15µ – 5000µ
- Working pressure: 35-150 psi
  - Higher pressures optional
- Material of Construction: Powder coated Carbon Steel.
  - Stainless steel optional
- Backwashing initiated automatically by time or pressure differential via integrated Rain Bird controller
- Flanged inlet and outlet standard except on HS-G-02 model filter only configurations which are threaded.
  - Grooved inlet and outlet configuration optional
- Available as filter only or as filter including bypass manifold and valves.



G-Series  
(Shown with integrated  
bypass assembly)

### G-Series Suction Scanning Screen Filter Performance Data

	300				200				120				100				Micron					
	50	75	125	140	50	75	125	140	50	75	125	140	50	75	125	140	Mesh					
Line Size (in)	Carbon Steel Model Number	PVC/Mesh Std. Flow Rate (GPM)				PVC/Mesh Screen Area (in <sup>2</sup> )				Sintered Screen Std. Flow Rate (GPM)				Sintered Screen Area (in <sup>2</sup> )				Rinse Duration (Seconds)	Flush Volume (Gallons)	Rinse Valve Size (in)	Minimum Inlet Pressure During Rinse Cycle (PSI)	Access Type
2	HS-G-02-LE	110	110	85	65	64	110	110	110	95	96	8-10	4-5	1	30	Bolted						
3	HS-G-03-LE	175	175	155	120	120	175	175	175	175	180	12-16	6-8	1	30	Bolted						
4	HS-G-04-LS	280	215	155	120	120	350	325	235	175	180	12-16	6-8	1	30	Bolted						
4	HS-G-04-LE	350	350	350	350	466	350	350	350	350	700	12-16	14-18	1.5	30	Bolted						

Flow rates shown above are based on water quality of 25 PPM or better (good water quality).

For water with particulate load greater than 25 PPM please consult Rain Bird for appropriate flow de-rating.

Drawings of standard filter models listed above are available on [www.rainbird.com](http://www.rainbird.com)



## I+ Series Hydraulic Suction Scanning Screen Filter

NEW

### Irrigation Uses

Self-cleaning line powered hydraulic water filters for turf, landscape, agriculture, greenhouse, golf course and nursery applications.

### Features

- Flow Rate: 15 – 7,350 gpm
- Max Temperature: 210° F
- Single electric ball valve for flushing operations standard
- 316 L stainless steel sintered screens standard
- Standard screen opening: 120μ
  - Optional: 15μ – 5000μ
- Working pressure: 35-150 psi
  - Higher pressures optional
- Material of Construction: Stainless Steel
- Backwashing initiated automatically by time or pressure differential via integrated Rain Bird controller
- Available as filter only or as filter including bypass manifold and valves.



I+ Series  
Stainless Steel

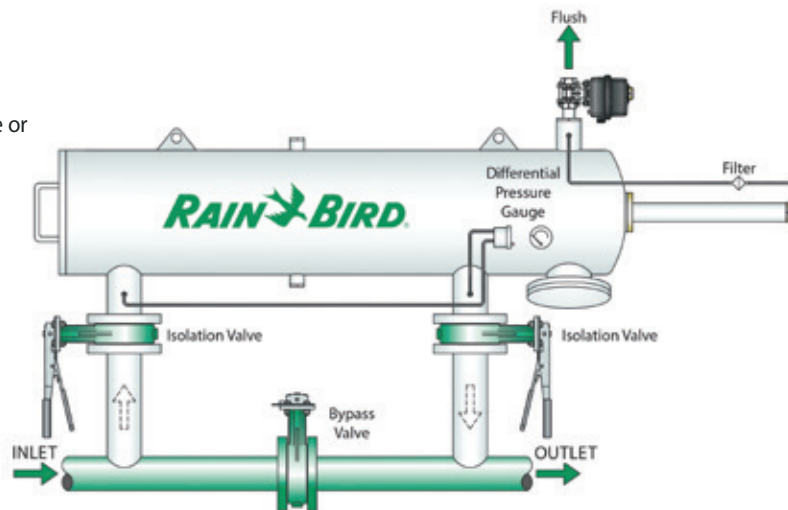

"I+ Series" Suction Scanning Screen Filter Performance Data

Line Size (in)	Stainless Steel Model Number	Std. Flow Rate (GPM)				Sintered Screen Area		Rinse Duration (Seconds)	Flush Volume (Gallons)	Flush Line Size (in)	Minimum Inlet Pressure During Rinse Cycle (PSI)
		300	200	120	100	Micron	Mesh				
4	HS-C-04-A-S	500	500	500	500	3.00	432	10 to 30	15 to 50	1.5	35
4	HS-I-04-B-S	500	500	500	500	5.25	756	10 to 30	15 to 50	1.5	35
4	HS-I-04-D-S	500	500	500	500	9.25	1332	10 to 30	35 to 110	2	35
6	HS-C-06-B-S	1000	1000	960	920	4.00	576	6 to 10	10 to 16	1.5	35
6	HS-I-06-B-S	1000	1000	1000	1000	5.25	756	10 to 30	15 to 50	1.5	35
6	HS-I-06-D-S	1000	1000	1000	1000	9.25	1332	10 to 30	35 to 110	2	35
8	HS-C-08-C-S	1000	1000	1000	1000	5.00	720	6 to 10	10 to 16	1.5	35
8	HS-I-08-B-S	1400	1260	1100	1050	5.25	756	10 to 30	15 to 50	1.5	35
8	HS-I-08-D-S	2000	2000	1943	1850	9.25	1332	10 to 30	35 to 110	2	35
10	HS-I-10-D-S	2000	2000	1943	1850	9.25	1332	10 to 30	35 to 110	2	35
12	HS-I-12-D-S	2000	2000	1943	1850	9.25	1332	10 to 30	35 to 110	2	35

Flow rates shown above are based on water quality of 25 PPM or better (good water quality).  
For water with particulate load greater than 25 PPM please consult Rain Bird for appropriate flow de-rating.  
Drawings of standard filter models listed above are available on [www.rainbird.com](http://www.rainbird.com)

## E+ Series and E0+ Series Electric Suction Scanning Screen Filter



• Available as a filter unit only, or as a filter assembly including bypass manifold and valves.

### Irrigation Uses

Rain Bird's E+ and E0+ Series automatic self-cleaning water filters utilize an electric motor to assist in cleaning during the backwash cycle in turf, landscape, agriculture, greenhouse, golf course, nursery applications and emerging green and blue industries like Aquaculture.

### Filter Characteristics:

- E+ Series filters are parallel flanged
- E0+ filters are straight flanged
- Flow Rate: 15 – 7,350 gpm
- Max Temperature: 210° F
- Single electric ball valve for flushing operations standard
- 316 L stainless steel sintered screens standard
- Standard screen opening: 120µ
  - Optional: 15µ – 5000µ
- Working pressure: 15 - 150 psi
- Materials of Construction: Stainless Steel
- Backwashing initiated automatically by time or pressure differential via integrated Rain Bird controller

E+ and E0+ Series  
Stainless Steel

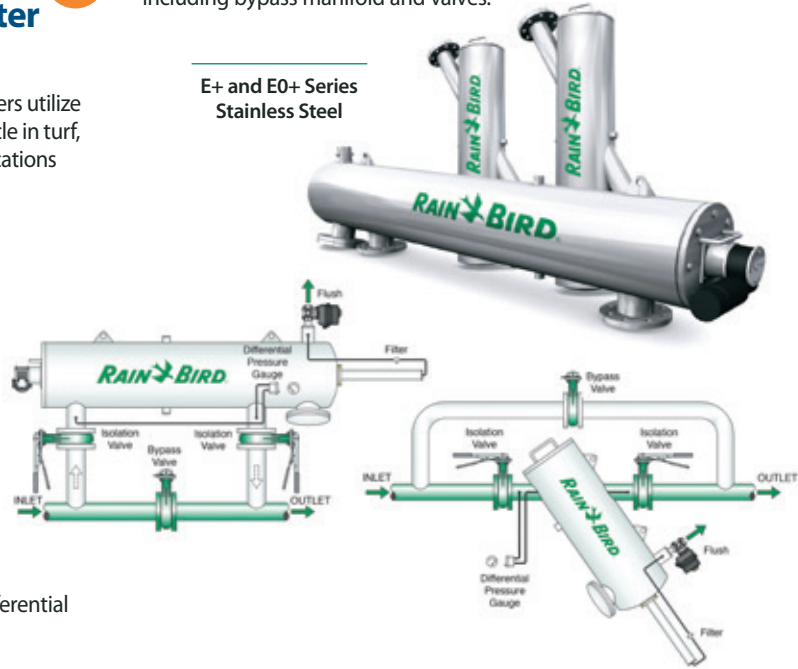

### "E+ Series" and "E0+ Series" Electric Suction Scanning Screen Filter Performance Data

E+ Series Models	E0+ Series Models	Line Size (in)	300	200	120	100	Micron	Sintered Screen Area (in <sup>2</sup> )	Flush Volume (Gallons)	Flush Line Size (in)
			50	80	125	140	Mesh			
Stainless Steel Model Number	Stainless Steel Model Number		Std. Flow Rate (gpm)	Std. Flow Rate (gpm)	Std. Flow Rate (gpm)	Std. Flow Rate (gpm)				
HS-E-02-A-S	HS-E0-02-A-S	2	200	200	200	200	2.65	382	15 to 50	1.5
HS-E-03-A-S	HS-E0-03-A-S	3	300	300	300	300	2.65	382	15 to 50	1.5
HS-E-04-A-S	HS-E0-04-A-S	4	500	500	500	500	2.65	382	15 to 50	1.5
HS-E-04-B-S	HS-E0-04-B-S	4	500	500	500	500	5.25	756	15 to 50	1.5
HS-E-04-C-S	HS-E0-04-C-S	4	500	500	500	500	7.00	1008	15 to 50	1.5
HS-E-04-D-S	HS-E0-04-D-S	4	500	500	500	500	9.25	1332	35 to 110	2
HS-E-06-A-S	HS-E0-06-A-S	6	650	630	555	530	2.65	382	15 to 50	1.5
HS-E-06-B-S	HS-E0-06-B-S	6	1000	1000	1000	1000	5.25	756	15 to 50	1.5
HS-E-06-C-S	HS-E0-06-C-S	6	1000	1000	1000	1000	7.00	1008	15 to 50	1.5
HS-E-06-D-S	HS-E0-06-D-S	6	1000	1000	1000	1000	9.25	1332	35 to 110	2
HS-E-08-B-S	HS-E0-08-B-S	8	1400	1260	1100	1050	5.25	756	15 to 50	1.5
HS-E-08-C-S	HS-E0-08-C-S	8	1700	1680	1470	1400	7.00	1008	15 to 50	1.5
HS-E-08-D-S	HS-E0-08-D-S	8	2000	2000	1943	1850	9.25	1332	35 to 110	2
HS-E-10-C-S	HS-E0-10-C-S	10	1900	1680	1470	1400	7.00	1008	15 to 50	1.5
HS-E-10-D-S	HS-E0-10-D-S	10	2000	2000	1943	1850	9.25	1332	35 to 110	2
HS-E-10-E-S	HS-E0-10-E-S	10	2700	2700	2573	2450	12.25	1764	35 to 110	2
HS-E-12-D-S	HS-E0-12-D-S	12	2000	2000	1943	1850	9.25	1332	35 to 110	2
HS-E-12-E-S	HS-E0-12-E-S	12	3100	2940	2573	2450	12.25	1764	35 to 110	2
HS-E-12-F-S	HS-E0-12-F-S	12	3800	3660	3200	3050	15.25	2196	35 to 110	2
HS-E-14-E-S	HS-E0-14-E-S	14	3100	2940	2573	2450	12.25	1764	35 to 110	2
HS-E-14-F-S	HS-E0-14-F-S	14	3800	3660	3200	3050	15.25	2196	35 to 110	2
HS-E-14-G-S	HS-E0-14-G-S	14	4500	4320	3780	3600	18.00	2592	35 to 110	2
HS-E-16-E-S	HS-E0-16-E-S	16	3100	2940	2573	2450	12.25	1764	35 to 110	2
HS-E-16-F-S	HS-E0-16-F-S	16	3800	3660	3200	3050	15.25	2196	35 to 110	2
HS-E-16-G-S	HS-E0-16-G-S	16	4500	4320	3780	3600	18.00	2592	35 to 110	2
HS-E-16-H-S	HS-E0-16-H-S	16	6125	5880	5145	4900	24.50	3528	35 to 110	2
HS-E-18-F-S	HS-E0-18-F-S	18	3800	3660	3200	3050	15.25	2196	35 to 110	2
HS-E-18-G-S	HS-E0-18-G-S	18	4500	4320	3780	3600	18.00	2592	35 to 110	2
HS-E-18-H-S	HS-E0-18-H-S	18	6125	5880	5145	4900	24.50	3528	35 to 110	2
HS-E-20-G-S	HS-E0-20-G-S	20	4500	4320	3780	3600	18.00	2592	35 to 110	2
HS-E-20-H-S	HS-E0-20-H-S	20	7350	5880	5145	4900	24.50	3528	35 to 110	2
HS-E-24-H-S	HS-E0-24-H-S	24	7350	5880	5145	4900	24.50	3528	35 to 110	2
HS-E-30-H-S	HS-E0-30-H-S	30	7350	5880	5145	4900	24.50	3528	35 to 110	2

\*\*The above calculated flow rates are based on good quality water. For fair, poor or bad water contact Rain Bird. Drawings of standard filter models are available at [www.rainbird.com](http://www.rainbird.com)  
Standard Rain Bird controllers: Auto-EC-2-E 110/220V (Series filters integrated with a Rain Bird Pump station are controlled by pump station PLC).

## PSS Series Self-Cleaning Pump Suction Screen

Keep Debris Out of Your Pump and Irrigation System

### Features

- Galvanized, Self-Cleaning Pump Suction Screen removes large trash and debris from water sources, saving time and money in energy, pumping efficiency and maintenance costs
- All water must pass through the pump suction screen attached to the end of the pump suction line before entering the pump intake pipe. A small, side-stream from the pump discharge plumbing drives two spray bars that continually rotate, jetting water at the screen and blasting debris away
- Heavy 12 mesh stainless steel screen increases your pump efficiency for many years to come

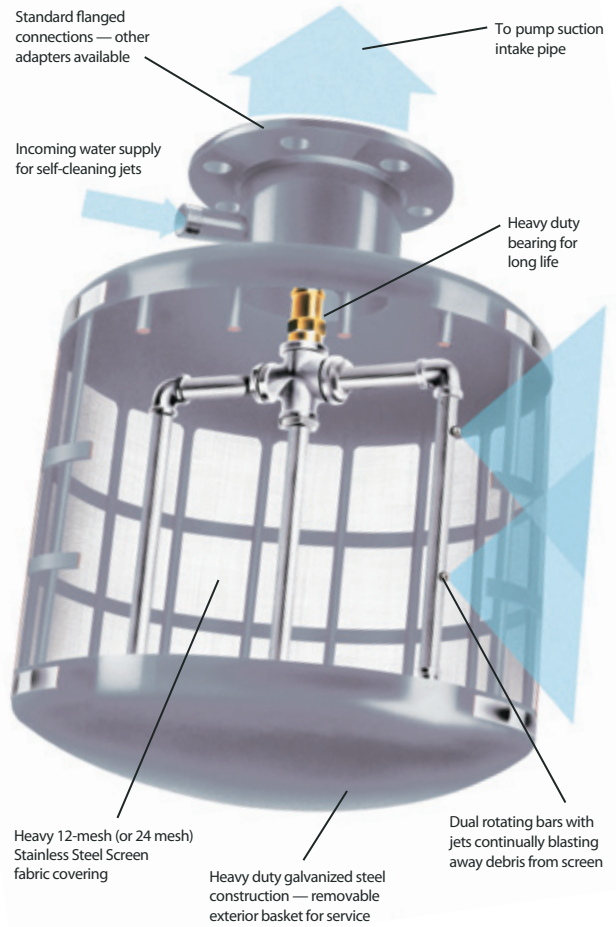

### 12 Mesh Self-Cleaning Pump Suction Screen Performance Data

Model Number	Flow US GPM	Flow m <sup>3</sup> /Hour	Screen Length (in)	Total Length (in)	Screen Diameter (in)	Flange Size (in)	Return Inlet Pipe Size (in)	Operating Pressure (min - max psi)	Weight Lbs.	Cleaning Spray (GPM)
<b>12 Mesh Filter</b>										
PSS200	325	73.8	11	25	16	4	1.5	35-100	38	20
PSS400	550	124.9	15	28.8	16	6	1.5	40-100	57	20
PSS600	750	170.3	16	32.5	24	8	1.5	40-100	101	20
PSS800	950	215.7	18	34.5	24	10	1.5	45-100	108	20
PSS1000	1350	306.5	23	39.5	24	10	1.5	50-100	116	24
PSS1400	1650	374.6	26	42.5	24	12	1.5	55-100	128	24
PSS1700	1950	442.7	28	44.5	26	12	1.5	55-100	148	24
PSS2000	2350	533.5	32	48.5	26	14	1.5	60-100	160	24
PSS2400	2600	590.2	35	52.5	30	16	1.5	65-100	223	28
PSS3000	3000	681.0	40	57.5	30	16	1.5	40-65	236	44
PSS3500	3500	794.5	40	59.5	36	18	1.5	40-65	283	44
PSS4000	4000	908.0	40	63.5	42	18	1.5	40-65	358	44

Contact Rain Bird for drawings or visit [www.rainbird.com](http://www.rainbird.com) to download.

## CS Series Centrifugal Sand Separator

Remove contaminants to minimize required maintenance and increase efficiency

### Features

- Capacities of 4 to 8300 gpm
- Simple installation (no electrical power required)
- Efficient pre-filter to reduce sand load on downstream components
- Rain Bird Centrifugal Sand Separators are designed to separate abrasive particles before they can enter the irrigation system, keeping equipment clean and clear of debris, which minimizes the amount of maintenance required and increases operational efficiency
- The separator removes sand and particles that are heavier than water (materials with a specific gravity of 2 or greater)
- Liquids and solids enter the unit and begin traveling in a circular flow. This centrifugal action throws heavier particulates towards the filter walls and eventually downward in a spiral motion to the separation chamber. The particulates collect in the separation chamber and are purged manually from the system. The filtered water is then drawn to the separator's vortex and through the outlet
- An optional automatic purge controller and valve can be used on all applications to automate the purge process, which eliminates the need for manual flushing. Small vertical design separators may be wall mounted or supported by the system piping



Centrifugal Sand Separator

### Centrifugal Sand Separators Performance Data

Model Number	Flow* US GPM	Flow m <sup>3</sup> /Hour	Inlet / Outlet Line Size (in)	(in)	Length (cm)	Weight Lbs.	Max. Particle Size (in)	Flush Valve Size (in)
<b>Vertical Separators</b>								
VCS-R5V	4 - 10	0.9 - 2.3	0.5	20	50.8	13	0.625	1
VCS-R7V	10 - 20	2.3 - 4.6	0.75	20	50.8	15	0.375	1
VCS-R10V	18 - 38	4 - 8.7	1	30.5	77.5	26	0.5	1
VCS-R12V	26 - 52	6 - 12	1.25	30.5	77.5	26	0.5	1
VCS-R15V	38 - 79	8.7 - 18	1.5	30.5	77.5	26	0.5	1
VCS-R20V	63 - 120	14.5 - 27.6	2	36	91.4	44	0.5	2
VCS-R25V	100 - 180	23 - 41.4	2.5	44	111.8	55	0.5	2
VCS-R30V	125 - 260	28.8 - 59.8	3	48	121.9	75	0.5	2
VCS-R40V	190 - 345	43.7 - 79.4	4	52	132.1	120	0.5	2
<b>Angled Separators</b>								
ACS-R40LA	200 - 525	46 - 120	4	80	221	280	1.5	2
ACS-R60LA	365 - 960	84 - 220	6	106.25	293.4	493	1.5	2
ACS-R80LA	800 - 1600	184 - 369	8	114	316.9	722	1.5	2
ACS-R100LA	1300 - 2300	299 - 529	10	123.5	342.9	840	1.5	2
ACS-R120LA	2025 - 3400	465 - 782	12	139	396.2	1400	1.5	2
ACS-R140LA	2975 - 5000	684 - 1150	14	148	424.2	1550	2	2
ACS-R160LA	4000 - 6200	920 - 1426	16	160	462.3	1850	2	2
ACS-R180LA	5100 - 8300	1173 - 1909	18	177	462.3	2400	2	3

## HDF Series Disc Filters

Automatic self-cleaning disc filtration equipment

### Features

- Automatic self-cleaning disc filtration equipment with 2" valves and high density polyethylene manifolds
- Ideal for surface and well water containing both organic (algae) and inorganic materials: rivers, reservoirs, canals, waste water, and well water containing light sand (<3PPM) and other contaminants
- The patented system's helical action provides efficient cleaning
- Manufactured from engineered plastics to resist rust and corrosion from chemicals and water
- All units are factory tested prior to shipment
- Disc elements provide depth filtration -not just surface filtration
- Unit is pre-assembled with HDPE (High -density polyethylene) manifold for easy installation
- DP, time or manual backflush cycle can be imitated from the controller
- Plastic backflush valves are lightweight and corrosion resistant.
- Low maintenance and performs reliable backflush
- Filtration disc versatility (filtration grades can be easily changed)
- Available with 100, 130, 200 or 400 micron discs (specify when ordering)

### Rain Bird HDF Series 1X2 filter backwash.

- **FILTRATION STAGE:** As water goes through the discs, particles are projected away due to the cyclone effect, reducing the backflushing frequency
- **BACKFLUSHING STAGE:** Water is projected through the discs, expelling the retained particles and evacuating them through the drainage manifold while the rest of the equipment is still in the filtration stage, supplying the remaining installation

### Rain Bird HDF Series-2 systems backwashes one station at a time while the remaining elements continue filtering.

- **FILTRATION STAGE:** As water goes through the discs, particles are projected away and kept in suspension due to the cyclone effect, reducing the backflushing frequency.
- **BACKFLUSHING STAGE:** Water is projected through the discs, expelling the retained particles and evacuating them through the drainage manifold. The rest of the filters battery continue filtering. The filtration process restarts when the discs recompress. The backflush process is controlled by the Rain Bird Control Unit.



HDF Series 1x2 Disc Filters



Rain Bird Filtron 110 Control Unit allows backwash activation by time or pressure differential.

Control Units are available in 12 VDC, 110 VAC and 220 VAC.

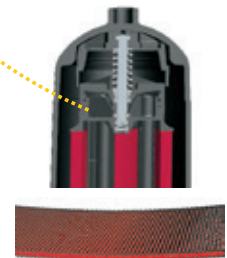

HDF Series-2 Disc Filters



HDF Series 4 Disc Filters

## HDF Series Disc Filters (cont.)

### Specifications

#### HDF Series 1x2 Disc Filters

- Suited for areas with or without electricity.
- Ideal where manual cleaning is troublesome.
- Compact design fits in tight spaces.
- Control Unit functions on pressure differential or time.
- Automatic self-cleaning 2" filter for low flow ranges.
- Maximum Flow: 106 gpm (24 m<sup>3</sup>/h)
- Maximum filtering surface (231 in<sup>2</sup>/1492 cm<sup>2</sup>).
- Maximum pressure: 145 psi (10 bar)
- Maximum temperature: 140° F (60° C)
- Standard 100 micron : Optional 130, 200 or 400 micron.

#### HDF Series 2 Disc Filters

- Suitable for surface and well waters containing both organic (algae) and inorganic materials.
  - Rivers, reservoirs, canals and waste water
- Well water containing light sand (<3 PPM) and other contaminants.
- Maximum flow: 845 gpm (192 m<sup>3</sup>/h)
- Maximum filtering surface: (231 in<sup>2</sup>/1492 cm<sup>2</sup>)
- Maximum pressure: 145 psi (10 bar)
- Maximum temperature: 140° F (60° C)
- Standard: 100 micron. Optional: 20, 50, 130, 200 or 400 micron.

### Control Units

- Rain Bird Filtron 110 allows backwash activation by time or pressure differential. Controllers are available in 12 VDC, 110 VAC and 220 VAC.

HDF Series 1x2 Disc Filters Specifications				
Model Number	Number of Filters	Manifold	Filtering Surface	
			(in)	(cm)
1X2/2G	1-2"	Inlet: 2" PVC Outlet: 2" NPT Drainage: 2: NPT	231	1492

HDF Series 2 Disc Filters Specifications				
Model Number	Number of Filters	Manifold	Filtering Surface	
			(in)	(cm)
2X2/3G	2	3"- GROOVED	463	2,984
3X2/4G	3	4"- GROOVED	694	4,476
4X2/6G	4	6"- GROOVED	925	5,968
5X2/6G	5	6"- GROOVED	1,156	7,460
6X2/6G	6	6"- GROOVED	1,388	8,952
7X2/6G	7	6"- GROOVED	1,619	10,444
8X2/8G	8	8"- GROOVED	1,850	11,936

Drainage manifolds included.

Dimensions of the models with flange connection. 2", 3", 4", 6" and 8" Dyrson grooved flanges are available.

Consult factory for other configurations.

Rain Bird reserves the right to change the characteristics of these products without prior notice.

**HDF Series 4 Disc Filtration systems for flows of 850 GPM and higher quoted upon request.**

## Rain Bird Filtration Controller



F2 AC/DC-P Specifications
<b>INPUT</b>
115 - 230VAC
12 - 15VDC
230VAC (optional)
<b>OUTPUT</b>
24VAC, 12VDC
<b>FEATURES</b>
Up to Two (2) stations plus master valve
Input voltage 115, 230 VAC (optional) 12VDC
Output selectable to operate 24VAC, 12VDC solenoids
Pressure differential (PD) gauge included
Fixed PD delay
Resettable backwash count
Resettable alarm
Plastic outdoor box
Periodic, manual, or pressure differential (PD) actuation
Accurate timing
Simple programming



***The newest name in drainage is the one you already trust.***

*For decades, we've been finding new ways to use water more intelligently. We're proud to introduce a few more: Rain Bird drainage products. Ruggedly constructed and designed to work together, these drainage grates, basins, adapters and accessories can help you efficiently manage water run-off for virtually any residential, commercial or municipal site. Put them in the ground. You'll see why they're the first drainage products worthy of the Rain Bird name.*

## Water Saving Water Saving Tips

- Installing a well-designed drainage system will result in the collection and capture of rain, runoff water and standing water from the site.
- The collected water can then be directed to an on-site storage tank, treated (if required) and pumped on an "as needed" basis to feed a Rain Bird water efficient irrigation system.
- Drainage systems can reduce damage to structures by directing water away from the foundation of the structure to a more desirable area on the site.
- A Rain Bird Drainage Pop-Up Valve (DPUV) can be installed at the lowest point of the piping network to allow for the collected water to slowly percolate into the soil and recharge the ground water supply.
- A properly installed drainage system can eliminate issues on the site caused by rushing or standing water which can result in soil erosion, plant disease and structural damage.
- Remember, water always runs downhill. Make sure that there is at least a 2% elevation difference between the high-end and the low-end of the drainage system.

### New Product Category. Same Toughness.

No shortcuts here. Our grates, basins and drainage accessories were engineered with the same exacting standards of a Rain Bird spray head, valve or controller.

#### Proven Reliability

We have a reputation to protect. Rain Bird drainage products are built using the highest quality materials and rigorously tested for durability.

#### Three-Year Warranty

You need products that will last long after the job's done. That's why we stand behind our drainage products with the longest warranty in the drainage product category.

**All Rain Bird drainage purchases qualify for valuable Rain Bird Rewards points.**

#### Round Catch Basin

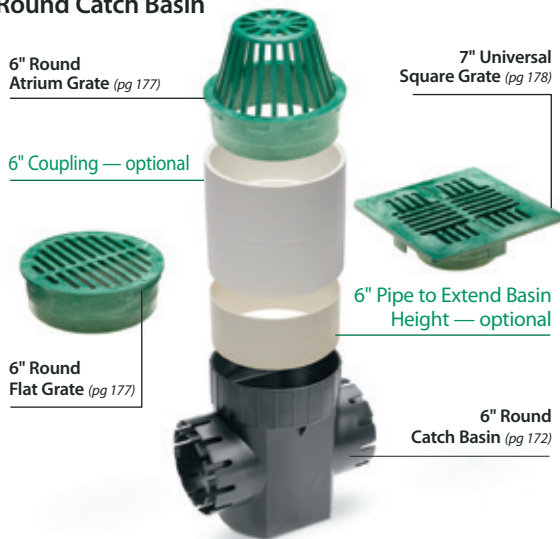

#### Compatible Drainage Pipe

(not manufactured by Rain Bird)



### Color, Size and Style are Optional. Loose Fits are Not.

No matter the job, you'll have the equipment you need to do it right. We offer grates and basins of varying dimensions, shapes and colors—all designed to fit together for tight, worry-free connections.

#### Recycled Plastics

All drainage models are constructed from 100% recycled plastic and therefore qualify for points on LEED projects.

#### Full Compatibility

Any way you put them together, our grates and basins will give you the best fit. For easy upgrades and quick replacements, our products are also compatible with components from most other drainage manufacturers.

#### Low-Profile Basin

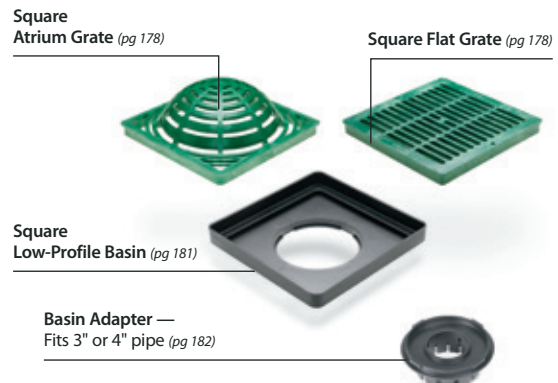

#### Square Catch Basin

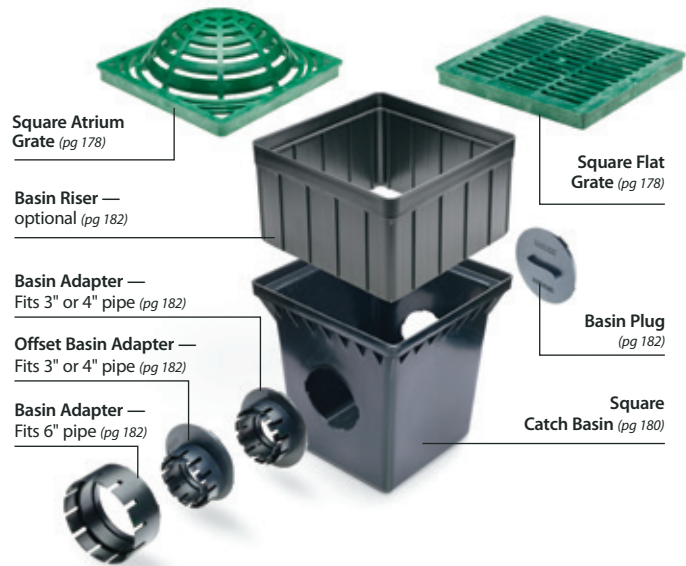



## Plastic Round Grates

### Features

- Manufactured from structurally foamed High-Density Polyethylene (HDPE)
- UV stabilized to protect from sun degradation
- Each grate has three stepped diameters to fit Sewer and Drain (S & D) Pipe and Fittings, Triple Wall Pipe and Corrugated Pipe
- Textured anti-skid surface<sup>1</sup>
- Load rated for pedestrian traffic<sup>1,2</sup>
- Load rated for autos and light trucks at speeds less than 20 mph<sup>1,2</sup>
- ADA compliant<sup>1</sup>

### Flat



3"  
DG3RFG



4"  
DG4RFG



6"  
DG6RFG

### Atrium



3"  
DG3RAG



4"  
DG4RAG



6"  
DG6RAG

Model Number	Color	Each Diameter Fits			Open Slot Width	Open Surface Area	Maximum Flow Rating	Maximum Load
		Small	Medium	Large				
<b>3" Round Flat</b>								
DG3RFG	Green	3" Triple Wall Pipe	3" S & D Pipe (ASTM D2729)	3" S & D Fittings (SDR 35)	3/16"	3 sq in	3 GPM	500 lbs
DG3RFB	Black		3" Corrugated Pipe					
<b>4" Round Flat</b>								
DG4RFG	Green	4" Triple Wall Pipe	4" S & D Pipe (ASTM D2729)	4" S & D Fittings (SDR 35)	1/4"	5 sq in	6 GPM	750 lbs
DG4RFB	Black		4" Corrugated Pipe					
<b>6" Round Flat</b>								
DG6RFG	Green	6" Sewer Pipe (ASTM D3034, SDR 35)	6" S & D Pipe (ASTM D2729)	6" S & D Fittings (SDR 35) 6" Round Catch Basins (DB6R1 & DB6R2)	5/16"	13 sq in	16 GPM	1,000 lbs
DG6RFB	Black		6" Corrugated Pipe					
<b>3" Round Atrium</b>								
DG3RAG	Green	3" Triple Wall Pipe	3" S & D Pipe (ASTM D2729)	3" S & D Fittings (SDR 35)	1/4"	9 sq in	12 GPM	NA
DG3RAB	Black		3" Corrugated Pipe					
<b>4" Round Atrium</b>								
DG4RAG	Green	4" Triple Wall Pipe	4" S & D Pipe (ASTM D2729)	4" S & D Fittings (SDR 35)	5/16"	16 sq in	20 GPM	NA
DG4RAB	Black		4" Corrugated Pipe					
<b>6" Round Atrium</b>								
DG6RAG	Green	6" Sewer Pipe (ASTM D3034, SDR 35)	6" S & D Pipe (ASTM D2729)	6" S & D Fittings (SDR 35) 6" Round Catch Basins (DB6R1 & DB6R2)	3/8"	28 sq in	36 GPM	NA
DG6RAB	Black		6" Corrugated Pipe					

<sup>1</sup>Flat grate only

<sup>2</sup>Maximum load rating based on basin encased in concrete and weight uniformly applied across entire grate surface

## Plastic Square Grates

### Features

- Manufactured from structurally foamed High-Density Polyethylene (HDPE)
- UV stabilized to protect from sun degradation
- Textured anti-skid surface<sup>1</sup>
- Load rated for autos and light trucks at speeds less than 20 mph<sup>1,2</sup>
- Includes two screw holes to secure to basin<sup>3</sup>
- ADA compliant<sup>1</sup>

### Flat

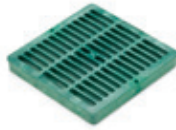

9"  
DG9SFG

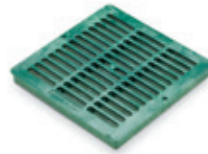

12"  
DG12SFG



18"  
DG18SFG

### Atrium



9"  
DG9SAG



12"  
DG12SAG

Model Number	Color	Fits	Open Slot Width	Open Surface Area	Maximum Flow Rating	Maximum Load
<b>9" Square Flat</b>						
DG9SFG	Green	9" Square Catch Basin (DB9S2)	3/8"	38 sq in	50 GPM	2,000 lbs
DG9SFB	Black	9" Low-Profile Basin (DB9SLP)				
<b>12" Square Flat</b>						
DG12SFG	Green	12" Square Catch Basins (DB12S2 & DB12S4)	7/16"	53 sq in	70 GPM	3,000 lbs
DG12SFB	Black	12" Low-Profile Basin (DB12SLP)				
<b>18" Square Flat</b>						
DG18SFG	Green	18" Square Catch Basins (DB18S2 & DB18S4)	15/32"	92 sq in	120 GPM	4,000 lbs
DG18SFB	Black					
<b>9" Square Atrium</b>						
DG9SAG	Green	9" Square Catch Basin (DB9S2)	3/8"	31 sq in	40 GPM	NA
DG9SAB	Black	9" Low-Profile Basin (DB9SLP)				
<b>12" Square Atrium</b>						
DG12SAG	Green	12" Square Catch Basins (DB12S2 & DB12S4)	7/16"	50 sq in	65 GPM	NA
DG12SAB	Black	12" Low-Profile Basin (DB12SLP)				

<sup>1</sup>Flat grate only      <sup>2</sup>Maximum load rating based on basin encased in concrete and weight uniformly applied across entire grate surface

<sup>3</sup>Use #6 1.5" long Phillips flat head stainless screws

## Universal Square Grates

### Features

- Manufactured from structurally foamed High-Density Polyethylene (HDPE)
- UV stabilized to protect from sun degradation
- Textured anti-skid surface
- Load rated for pedestrian traffic<sup>1</sup>
- ADA compliant



DG7USG

Model Number	Color	Fits	Open Slot Width	Open Surface Area	Maximum Flow Rating	Maximum Load
<b>7" Universal Square Flat</b>						
DG7USG	Green	<ul style="list-style-type: none"> <li>• 6" Round Catch Basin (DB6R1, DB6R2)</li> <li>• 3" or 4" S &amp; D Pipe (ASTM D2729)</li> <li>• 3" or 4" Corrugated Pipe</li> </ul>	1/4"	13 sq in	11 GPM	250 lbs
DG7USB	Black	<ul style="list-style-type: none"> <li>• 3" or 4" Triple Wall Pipe</li> <li>• 3", 4" or 6" S &amp; D Fittings (SDR 35)</li> </ul>				

<sup>1</sup>Maximum load rating based on basin encased in concrete and weight uniformly applied across entire grate surface

## Round Catch Basins

### Features

- Manufactured from High-Impact Polystyrene (HIPS)
- UV stabilized to protect from sun degradation
- Universal outlet(s) used to connect to 3" or 4" Sewer and Drain Pipe (ASTM D2729), 3" or 4" Corrugated Pipe and 3" or 4" Triple Wall Pipe
- Includes a sump to allow sediment to settle in basin to minimize clogging of pipes
- To extend height of basin, use 6" PVC Pipe (ASTM D2729 and ASTM D3034, SDR 35) as a riser



DB6R1

DB6R2

Model Number	Number of Outlets	Inlet (Top) Accepts	Outlet (Side) Fits	Capacity	Sump Capacity
<b>6" Round</b>					
DB6R1	1	<ul style="list-style-type: none"> <li>• 6" Round Flat and Atrium Grates</li> <li>• 7" Universal Square Grates</li> </ul>	<ul style="list-style-type: none"> <li>• 3" or 4" Corrugated Pipe</li> <li>• 3" or 4" Triple Wall Pipe</li> </ul>	0.80 gals	0.20 gals
DB6R2	2	<ul style="list-style-type: none"> <li>• 6" PVC Pipe (ASTM D2729, ASTM D3034, SDR 35)</li> </ul>	<ul style="list-style-type: none"> <li>• S &amp; D Pipe (ASTM D2729)</li> </ul>		

### Square Catch Basins

#### Features

- Manufactured from High-Density Polyethylene (HDPE)
- UV stabilized to protect from sun degradation
- Use a 3" and 4" Basin Adapter to connect basin to 3" or 4" Corrugated Pipe and 3" or 4" Triple Wall Pipe
- Use a 6" Basin Adapter to connect basin to 6" PVC Pipe (ASTM D2729 and ASTM D3034, SDR 35) and 6" Corrugated Pipe
- Use a Basin Plug to plug unused outlets
- Use 9" or 12" Square Basin Riser(s) to extend height of 9" and 12" Square Catch Basins by 6" in height, respectively
- Includes a sump to allow sediment to settle in basin to minimize clogging of pipes
- Includes four screw holes to enable grates to be secured to basin



Model Number	Number of Outlets	Inlet (Top) Accepts	Outlet (Side) Fits	Capacity	Sump Capacity
<b>9" Square, 2 Outlets</b>					
DB9S2	2	<ul style="list-style-type: none"> <li>• 9" Square Flat Grates</li> <li>• 9" Square Atrium Grates</li> <li>• 9" Square Basin Riser (DBRE9)</li> </ul>	<ul style="list-style-type: none"> <li>• Basin Plug (DBAAP)</li> <li>• 3" &amp; 4" Basin Adapter (DBAA34 or DBAAO34)</li> <li>• 6" Basin Adapter (DBAA6)</li> </ul>	2.20 gals	0.45 gals
<b>12" Square, 2 Outlets</b>					
DB12S2	2	<ul style="list-style-type: none"> <li>• 12" Square Flat Grates</li> <li>• 12" Square Atrium Grates</li> <li>• 12" Square Basin Riser (DBRE12)</li> </ul>	<ul style="list-style-type: none"> <li>• Basin Plug (DBAAP)</li> <li>• 3" &amp; 4" Basin Adapter (DBAA34 or DBAAO34)</li> <li>• 6" Basin Adapter (DBAA6)</li> </ul>	5.10 gals	1.25 gals
<b>18" Square, 2 Outlets</b>					
DB18S2	2	<ul style="list-style-type: none"> <li>• 18" Square Flat Grates</li> </ul>	<ul style="list-style-type: none"> <li>• Basin Plug (DBAAP)</li> <li>• 3" &amp; 4" Basin Adapter (DBAA34 or DBAAO34)</li> <li>• 6" Basin Adapter (DBAA6)</li> </ul>	16.70 gals	4.90 gals

## Square Low-Profile Basins

### Features

- Manufactured from High-Impact Polystyrene (HIPS)
- UV stabilized to protect from sun degradation
- One bottom outlet designed to accept all Basin Adapters
- Use a 3" and 4" Basin Adapter to connect to 3" or 4" Corrugated Pipe and 3" or 4" Triple Wall Pipe
- Use a 6" Basin Adapter to connect to 6" PVC Pipe (ASTM D2729 and ASTM D3034, SDR 35) and 6" Corrugated Pipe
- Accepts 9" and 12" Square Flat Grates
- Accepts 9" and 12" Square Atrium Grates
- Includes two screw holes to enable grates to be secured to Low-Profile Basin
- Made in the USA

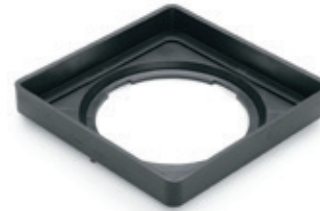

DB9SLP

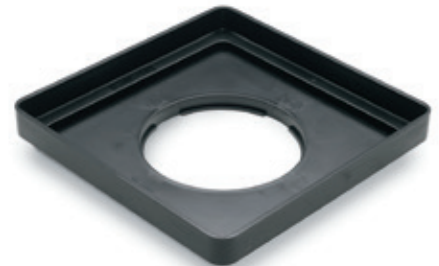

DB12SLP

Model Number	Inlet (Top) Accepts	Outlet (Side) Fits
<b>9" Square</b>		
DB9SLP	<ul style="list-style-type: none"> <li>• 9" Square Flat Grates</li> <li>• 9" Square Atrium Grates</li> <li>• 9" Square Basin Riser (DBRE9)</li> </ul>	<ul style="list-style-type: none"> <li>• 3" &amp; 4" Basin Adapter (DBAA34 or DBAA034)</li> <li>• 6" Basin Adapter (DBAA6)</li> </ul>
<b>12" Square</b>		
DB12SLP	<ul style="list-style-type: none"> <li>• 12" Square Flat Grates</li> <li>• 12" Square Atrium Grates</li> <li>• 12" Square Basin Riser (DBRE12)</li> </ul>	<ul style="list-style-type: none"> <li>• 3" &amp; 4" Basin Adapter (DBAA34 or DBAA034)</li> <li>• 6" Basin Adapter (DBAA6)</li> </ul>

## Square Basin Kits

For your convenience, Basin Kits are available with the most popular basin, grate and adapter components required on most jobs.

Model Number	Each Kit Includes	
<b>9" Square Basin Kit</b>		
DB9KITG	<ul style="list-style-type: none"> <li>• 9" Square Basin with two outlets (DB9S2)</li> <li>• Two 3" and 4" Adapters (DBAA34)</li> </ul>	<ul style="list-style-type: none"> <li>• Basin Plug (DBAAP)</li> <li>• 9" Square Flat Grate, GREEN (DG9SFG)</li> </ul>
DB9KITB	<ul style="list-style-type: none"> <li>• 9" Square Basin with two outlets (DB9S2)</li> <li>• Two 3" and 4" Adapters (DBAA34)</li> </ul>	<ul style="list-style-type: none"> <li>• Basin Plug (DBAAP)</li> <li>• 9" Square Flat Grate, BLACK (DG9SFB)</li> </ul>
<b>12" Square Basin Kit (not shown)</b>		
DB12KITG	<ul style="list-style-type: none"> <li>• 12" Square Basin with two outlets (DB12S2)</li> <li>• Two 3" and 4" Adapters (DBAA34)</li> </ul>	<ul style="list-style-type: none"> <li>• Basin Plug (DBAAP)</li> <li>• 12" Square Flat Grate, GREEN (DG12SFG)</li> </ul>
DB12KITB	<ul style="list-style-type: none"> <li>• 12" Square Basin with two outlets (DB12S2)</li> <li>• Two 3" and 4" Adapters (DBAA34)</li> </ul>	<ul style="list-style-type: none"> <li>• Basin Plug (DBAAP)</li> <li>• 12" Square Flat Grate, BLACK (DG12SFB)</li> </ul>



DB9KITG

## Drainage Pop-Up Valves

### Features

- Available in four configurations
- Pop-up valve body manufactured from structurally foamed High-Density Polyethylene (HDPE)
- Elbow (where applicable) manufactured from PVC
- Adapter (where applicable) manufactured from High Impact Polystyrene (HIPS)
- UV stabilized to protect from sun degradation
- Spring-loaded cover rises ½" to discharge excess water in system
- Spring automatically retracts cover to closed position after excess water is discharged
- Can be used in both vertical and horizontal position
- Stainless steel spring to prevent rusting
- PVC elbows (where applicable) include a ¼" drain hole to eliminate standing water
- Made in the USA



Model Number	Color	Description	Connects To
DPUV3E	Green	Drainage Pop-Up Valve with 3" PVC Elbow	<ul style="list-style-type: none"> <li>• 3" S &amp; D Pipe (ASTM D2729)</li> <li>• 3" Triple Wall Pipe</li> </ul>
DPUV4EHUB	Green	Drainage Pop-Up Valve with 4" PVC Elbow and Adapter (DPAFHA34)	<ul style="list-style-type: none"> <li>• 3" or 4" Corrugated Pipe</li> <li>• 3" or 4" Triple Wall Pipe</li> <li>• 3" or 4" S &amp; D Pipe (ASTM D2729)</li> </ul>

## Basin Adapters and Accessories



Model Number	Description	Use
DBAAP	Basin Plug	<ul style="list-style-type: none"> <li>• Blocks 9", 12" &amp; 18" Square Basin side outlets</li> </ul>
DBAA34	3" and 4" Basin Adapter	<ul style="list-style-type: none"> <li>• Adapts 9", 12" and 18" Square Basin side outlets and 9" &amp; 12" Low-Profile Basin outlets to 3" or 4" PVC and Corrugated Pipe</li> </ul>
DBAAO34	3" and 4" Offset Basin Adapter	<ul style="list-style-type: none"> <li>• Adapts 9", 12" &amp; 18" Square Basin side outlets and 9" &amp; 12" Low-Profile Basin outlets to 3" or 4" PVC and Corrugated Pipe</li> </ul>
DBAA6	6" Basin Adapter	<ul style="list-style-type: none"> <li>• Adapts 9", 12" &amp; 18" Square Basin side outlets and 9" &amp; 12" Low-Profile Basin outlets to 6" PVC and Corrugated Pipe</li> </ul>
DPAFH34	Fitting Adapter	<ul style="list-style-type: none"> <li>• Adapts 3" or 4" Triple Wall Pipe to 3" or 4" PVC and Corrugated Pipe</li> </ul>
DBRE9	9" Square Basin Riser	<ul style="list-style-type: none"> <li>• Extends height of 9" Square Basin or 9" Low-Profile Basin by 6"</li> </ul>
DBRE12	12" Square Basin Riser	<ul style="list-style-type: none"> <li>• Extends height of 12" Square Basin or 12" Low-Profile Basin by 6"</li> </ul>

## Your 24/7 Information Resource

The Rain Bird website is your one-stop source for the latest product information and news updates from Rain Bird. Stop by anytime, day or night, and download exactly what you need to be more effective on the job. Learn about the newest Rain Bird products, look up performance charts, download CAD detail drawings and much more.

**Visit [www.rainbird.com](http://www.rainbird.com) today and explore this state-of-the-art resource.**



## Rain Bird Online Resources and Contacts List

Programs and Marketing Resources	Contacts/Information
Design and Specification Resources	<a href="http://www.rainbird.com/landscape">www.rainbird.com/landscape</a> (Select from product list in left menu)
Distributor Portal Website	<a href="http://ww2.rainbird.com/turfdistributor">ww2.rainbird.com/turfdistributor</a>
Public and Non-Profit Agencies Portal	<a href="http://www.rainbird.com/agency">www.rainbird.com/agency</a>
Facebook	<a href="http://www.facebook.com/RainBirdCorp">www.facebook.com/RainBirdCorp</a>
Intelligent Use of Water™	<a href="http://www.rainbird.com/IUOW">www.rainbird.com/IUOW</a>
LEED Library	<a href="http://www.rainbird.com/LEED">www.rainbird.com/LEED</a>
Photos and Logos	<a href="http://www.rainbird.com/library">www.rainbird.com/library</a>
Product Catalog	<a href="http://www.rainbird.com/catalog">www.rainbird.com/catalog</a>
Product Demos and Interactive Guides	<a href="http://www.rainbird.com/landscape">www.rainbird.com/landscape</a> (Select from product list in left menu)
Product Literature and Tech Specs	<a href="http://www.rainbird.com/landscape/support">www.rainbird.com/landscape/support</a>
Rain Bird Agency Rewards (non-profits and government agencies)	<a href="http://www.rainbird.com/agency">www.rainbird.com/agency</a> • E-mail: <a href="mailto:rewards@rainbird.com">rewards@rainbird.com</a>
Rain Bird Rewards	<a href="http://ww2.rainbird.com/Rewards">ww2.rainbird.com/Rewards</a> • E-mail: <a href="mailto:rewards@rainbird.com">rewards@rainbird.com</a>
Rain Bird Training Services	<a href="http://www.rainbirdservices.com">www.rainbirdservices.com</a>
Rain Bird Virtual Museum	<a href="http://www.rainbird.com/museum">www.rainbird.com/museum</a>
Twitter	<a href="http://www.twitter.com/rainbirdcorp">www.twitter.com/rainbirdcorp</a>
Water Efficiency Calculators	<a href="http://www.rainbird.com/calculators">www.rainbird.com/calculators</a>
Webinars	<a href="http://www.rainbird.com/webinars">www.rainbird.com/webinars</a>
YouTube	<a href="http://www.youtube.com/rainbirdcorp">www.youtube.com/rainbirdcorp</a>



## Rain Bird Training Services

Dedicated to the Development of Irrigation Professionals

### Three Programs to Meet Your Needs

- Instructors are credentialed and experienced irrigation professionals
- Classes are pre-approved for Irrigation Association (IA) CEUs
- Classes are open to all green industry professionals



### Rain Bird Academy

#### General Irrigation Skills Training

- Top quality training on many manufactures' products
- Prepare for Irrigation Association (IA) exams
- The Rain Bird Academy Boot Camp delivers the basics of irrigation in one week.
  - Boot Camp classes are part of the IA Select Program



### Rain Bird Factory Trained

#### Comprehensive Training on Rain Bird Products

- Training is exclusive to Rain Bird Products
- Be an expert on installing, managing and maintaining Rain Bird irrigation systems.
- Get the designation that proves to your customers that you are the best choice to do the job!



### Rain Bird Customized Training

#### Customized and Private Classes

- Training is customized based on your organizations unique needs
- We come to your facility with everything needed to hold training
- From basic irrigation troubleshooting to central control, your staff will get the skills they need

For pricing and course registration, please visit: [www.rainbirdsolutions.com](http://www.rainbirdsolutions.com)



## Rain Bird Rewards

Supporting Your Business Success and Growth

You're working hard to build a successful business and Rain Bird Rewards is here to reward you. We have the benefits and tools you can use to attract new customers, train your employees and reduce costs. Reinvesting in your company and its future success has never been so easy.

Join today — and get the benefits you need to take your business to the next level.

### Help Your Business Succeed

- **Tools to grow your business.**

Use Rain Bird marketing materials to align your business with the industry leader.

- **Rewards you deserve.**

Points can be redeemed to reward your hard work and help you build a successful business.

- **Training discounts.**

Receive 20% off professional-level training from Rain Bird Training Services.

**Enroll today at [ww2.rainbird.com/rewards](http://ww2.rainbird.com/rewards).**



### Reward for Your Hard Work

Let Rain Bird reward your growing business now and in the future.

## Customer Service

At Rain Bird, we believe that when you purchase our products, you should also receive the support you need to ensure that they perform as designed. Like our products, Rain Bird customer service is designed to exceed expectations. When you call with questions about orders or new products, you get the support you need from the top water management professionals in the industry backed by our vast global network of distributor-partners.

## Worry-Free Warranties

Our comprehensive product warranties make it even easier to choose Rain Bird and relax. Most Rain Bird Landscape Irrigation products are warranted to the trade for a period of either three or five years from the date of original purchase. A Rain Bird warranty is hassle-free support that enables maximum peak performance by irrigation system professionals. For you, it's the added peace of mind of knowing Rain Bird is there when you need it.

### Rain Bird's Professional Customer Satisfaction Policy

Rain Bird will repair or replace at no charge any Rain Bird professional product that fails in normal use within the warranty period stated below. You must return it to the dealer or distributor where you bought it. Product failures due to acts of God including without limitation, lightning and flooding, are not covered by this warranty. This commitment to repair or replace is our sole and total warranty.

### Implied Warranties of Merchantability and Fitness, if Applicable, are Limited to One Year from the Date of Sale.

We will not, under any circumstances be liable for incidental or consequential damages, no matter how they occur.

#### I. Landscape Irrigation and Drainage Products

1800 Series Pop-Up Spray Heads, U-Series Nozzles, PA-8S and PA-8S-PRS Shrub Adapters, 1300 and 1400 Bubblers, 5000 Series Rotors, 5500 Series Rotors, 8005 Series Rotors, Falcon® 6504 Series Rotors, PEB/PESB/PESB-R Plastic Valves, DV/DVF and ASVF Plastic Valves, VB Series Valve Boxes and XF Series Dripline\* – 5 years

C2 Power Unit – 2 years

Pump Start Relays – 1 year for controls/electronics, 2 years for enclosure

All other Landscape Irrigation and Drainage products – 3 years

#### II. Golf Products, Agricultural Products, and Pump Stations

For complete information and details please visit:

<http://www.rainbird.com/corporate/CustomerSatisfactionPolicy.htm>

#### III. All Other Products - 1 year

*\*XF Series Dripline - 7 Years on Environmental Stress Cracking (ESCR)*

**For more information, see your Rain Bird Distributor. To find the nearest authorized distributor in your area, visit [www.rainbird.com](http://www.rainbird.com) or call 1-800-RAINBIRD**

## How to Use This Catalog

### Precipitation Rates

Rain Bird has calculated for you the precipitation rates for our comprehensive lines of impacts, sprays, and rotors. These rates are an indication of the approximate rate at which water is being applied. The equations used to calculate the precipitation rates are as follows:

Square Spacing		Triangular Spacing	
U.S.:	Metric:	U.S.:	Metric:
PR=96.3 x gpm	PR=1000 x m <sup>3</sup> /h	PR=96.3 x gpm	PR=1000 x m <sup>3</sup> /h
S x S	S x S	S x L	S x L

- 96.3 = Constant (inches/square foot/hour)
- 1000 = Constant (millimeter/square meter/hour)
- gpm = Gallons per minute (applied to area by sprinklers)
- m<sup>3</sup>/h = Cubic meters per hour (applied to area by sprinklers)
- S = Spacing between sprinklers
- L = Spacing between rows (S x 0.866)

### Specification Information

The information in this catalog was accurate at the time of printing and may be used for proper specification of each product. For the most up-to-date information, go to the Rain Bird web site at [www.rainbird.com](http://www.rainbird.com).

### ASABE Test Certification Statement

Rain Bird Corporation certifies that pressure, flow rate, and radius data for its products were determined and listed in accordance with ASABE Standard S398.1, Procedure for Sprinkler Testing and Performance Reporting, and are representative of performance of production sprinklers at the time of publication. Actual product performance may differ from the published specifications due to normal manufacturing variations and sample selection. All other specifications are solely the recommendations of Rain Bird Corporation.

### Reference Charts

Information contained in this catalog is based upon generally accepted formulas, computations, and trade practices. Rain Bird Corporation, and its subsidiaries and affiliates, shall not be responsible or liable therefore if any problems, difficulties, or injuries should arise from or in connection with the use or application of this information, or if there is any error herein, typographical or otherwise.

## Technical Support

Rain Bird Technical Support has the answers to your specific product and water-management questions. Call our toll-free Technical Service or Spec Hotline numbers, or for maximum convenience, access the Rain Bird web site. You'll get expert advice and the right solutions.

Technical Service	Spec Hotline	Internet Address
1-800-RAINBIRD (1-800-724-6247)	1-800-458-3005	<a href="http://www.rainbird.com">www.rainbird.com</a>

## Pressure Loss Through Water Meters

Flow gpm	5/8"	3/4"	1"	1 1/2"	2"	3"	4"
1	0.2	0.1					
2	0.3	0.2					
3	0.4	0.3					
4	0.6	0.5	0.1				
5	0.9	0.6	0.2				
6	1.3	0.7	0.3				
7	1.8	0.8	0.4				
8	2.3	1.0	0.5				
9	3.0	1.3	0.6				
10	3.7	1.6	0.7				
11	4.4	1.9	0.8				
12	5.1	2.2	0.9				
13	6.1	2.6	1.0				
14	7.2	3.1	1.1				
15	8.3	3.6	1.2				
16	9.4	4.1	1.4	0.4			
17	10.7	4.6	1.6	0.5			
18	12.0	5.2	1.8	0.6			
19	13.4	5.8	2.0	0.7			
20	15.0	6.5	2.2	0.8			
22		7.9	2.8	1.0			
24		9.5	3.4	1.2			
26		11.2	4.0	1.4			
28		13.0	4.6	1.6			
30		15.0	5.3	1.8			
32			6.0	2.1	0.8		
34			6.9	2.4	0.9		
36			7.8	2.7	1.0		
38			8.7	3.0	1.2		
40			9.6	3.3	1.3		
42			10.6	3.6	1.4		
44			11.7	3.9	1.5		
46			12.8	4.2	1.6		
48			13.9	4.5	1.7		
50			15.0	4.9	1.9	0.7	
52				5.3	2.1		
54				5.7	2.2		
56				6.2	2.3		
58				6.7	2.5		
60				7.2	2.7		
65				8.3	3.2	1.1	
70				9.8	3.7	1.3	
75				11.2	4.3	1.5	
80				12.8	4.9	1.6	0.7
90				16.1	6.2	2.0	0.8
100				20.0	7.8	2.5	0.9
110					9.5	2.9	1.0
120					11.3	3.4	1.2
130					13.0	3.9	1.4
140					15.1	4.5	1.6
150					17.3	5.1	1.8
160					20.0	5.8	2.1
170						6.5	2.4
180						7.2	2.7
190						8.0	3.0
200						9.0	3.2
220						11.0	3.9
240						13.0	4.7
260						15.0	5.5
280						17.3	6.3
300						20.0	7.2
350							10.0
400							13.0
450							16.2
500							20.0



PVC Class 200 IPS Plastic Pipe

(1120, 1220) SDR 21 C=150

psi Loss per 100 Feet of Pipe (psi/100 ft.)

Sizes 3/4" through 6" Flow 1 through 600 gpm

Nominal Size	3/4"	1"	1 1/4"	1 1/2"	2"	2 1/2"	3"	4"	6"	
Pipe OD	1.050	1.315	1.660	1.900	2.375	2.875	3.500	4.500	6.625	
Avg. ID	0.91	1.169	1.482	1.7	2.129	2.581	3.146	4.046	5.955	
Avg. Wall	0.070	0.073	0.089	0.100	0.123	0.147	0.177	0.227	0.335	
Tolerance	0.020	0.020	0.020	0.020	0.020	0.020	0.020	0.026	0.038	
Min. Wall	0.060	0.063	0.079	0.090	0.113	0.137	0.167	0.214	0.316	
Flow (gpm)	Velocity (ft/s)	Loss (psi)	Velocity (ft/s)	Loss (psi)	Velocity (ft/s)	Loss (psi)	Velocity (ft/s)	Loss (psi)	Velocity (ft/s)	Loss (psi)
1	0.49	0.07	0.30	0.02	0.19	0.01	0.14	0.00	0.09	0.00
2	0.99	0.24	0.60	0.07	0.37	0.02	0.28	0.01	0.18	0.00
3	1.48	0.52	0.90	0.15	0.56	0.05	0.42	0.02	0.27	0.01
4	1.97	0.88	1.19	0.26	0.74	0.08	0.56	0.04	0.36	0.01
5	2.46	1.33	1.49	0.39	0.93	0.12	0.71	0.06	0.45	0.02
6	2.96	1.86	1.79	0.55	1.11	0.17	0.85	0.09	0.54	0.03
7	3.45	2.47	2.09	0.73	1.30	0.23	0.99	0.12	0.63	0.04
8	3.94	3.17	2.39	0.94	1.49	0.30	1.13	0.15	0.72	0.05
9	4.43	3.94	2.69	1.17	1.67	0.37	1.27	0.19	0.81	0.06
10	4.93	4.79	2.99	1.42	1.86	0.45	1.41	0.23	0.90	0.08
11	5.42	5.72	3.28	1.69	2.04	0.53	1.55	0.27	0.99	0.09
12	5.91	6.71	3.58	1.98	2.23	0.63	1.69	0.32	1.08	0.11
14	6.90	8.93	4.18	2.64	2.60	0.83	1.98	0.43	1.26	0.14
16	7.88	11.44	4.78	3.38	2.97	1.07	2.26	0.55	1.44	0.18
18	8.87	14.23	5.37	4.21	3.34	1.33	2.54	0.68	1.62	0.23
20	9.85	17.29	5.97	5.11	3.72	1.61	2.82	0.83	1.80	0.28
22	10.84	20.63	6.57	6.10	4.09	1.92	3.11	0.99	1.98	0.33
24	11.82	24.24	7.17	7.17	4.46	2.26	3.39	1.16	2.16	0.39
26	12.81	28.11	7.76	8.31	4.83	2.62	3.67	1.34	2.34	0.45
28	13.80	32.25	8.36	9.53	5.20	3.01	3.95	1.54	2.52	0.52
30	14.78	36.64	8.96	10.83	5.57	3.41	4.24	1.75	2.70	0.59
35			10.45	14.41	6.50	4.54	4.94	2.33	3.15	0.78
40			11.94	18.45	7.43	5.82	5.65	2.98	3.60	1.00
45			13.44	22.95	8.36	7.24	6.35	3.71	4.05	1.24
50			14.93	27.90	9.29	8.79	7.06	4.51	4.50	1.51
55					10.22	10.49	7.76	5.38	4.95	1.80
60					11.15	12.33	8.47	6.32	5.40	2.11
65					12.07	14.30	9.18	7.33	5.85	2.45
70					13.00	16.40	9.88	8.41	6.30	2.81
75					13.93	18.63	10.59	9.56	6.75	3.20
80					14.86	21.00	11.29	10.77	7.20	3.60
85							12.00	12.05	7.65	4.03
90							12.71	13.40	8.10	4.48
95							13.41	14.81	8.55	4.95
100							14.12	16.28	9.00	5.45
110							9.90	6.50	6.74	2.55
120							10.80	7.63	7.35	2.99
130							11.70	8.85	7.96	3.47
140							12.60	10.16	8.57	3.98
150							13.50	11.54	9.19	4.52
160							14.40	13.01	9.80	5.10
170							10.41	5.70	7.01	2.18
180							11.02	6.34	7.42	2.42
190							11.64	7.01	7.83	2.67
200							12.25	7.71	8.24	2.94
225							13.78	9.58	9.28	3.66
250							15.31	11.65	10.31	4.45
275									11.34	5.30
300									12.37	6.23
325									13.40	7.23
350									14.43	8.29
375									9.35	2.77
400									9.97	3.12
425									10.59	3.49
450									11.22	3.88
475									11.84	4.29
500									12.46	4.72
550									13.71	5.63
600									14.95	6.61

Note: Dark shaded area of chart indicates velocities over 5' per second. Use with caution

The velocity values were derived using the following equation  $V = \frac{0.408 \times Q_{gpm}}{d^2}$

Table are based upon the following Hazen-Williams equation:  $H_f = 0.2083 \times \left(\frac{100}{C}\right)^{1.852} \times \frac{Q^{1.852}}{D^{4.8655}}$  for change in psi per foot of elevation. Pressure loss for uphill elevation and pressure gain for downhill elevation changes.

**PVC Class 315 IPS Plastic Pipe**  
 (1120, 1220) SDR 13.5 C=150

psi Loss per 100 Feet of Pipe (psi/100 ft.)

Sizes 1/2" through 6" Flow 1 through 600 gpm

Nominal Size	1/2"	3/4"	1"	1 1/4"	1 1/2"	2"	2 1/2"	3"	4"	6"		
Pipe OD	0.840	1.050	1.315	1.660	1.900	2.375	2.875	3.500	4.500	6.625		
Avg. ID	0.6960	0.8740	1.1010	1.3940	1.5980	2.0030	2.4230	2.9510	3.7940	5.5840		
Avg. Wall	0.072	0.088	0.107	0.133	0.151	0.186	0.226	0.275	0.353	0.521		
Tolerance	0.020	0.020	0.020	0.020	0.020	0.020	0.026	0.031	0.040	0.059		
Min. Wall	0.062	0.078	0.097	0.123	0.141	0.176	0.213	0.259	0.333	0.491		
Flow (gpm)	Velocity (ft/s)	Loss (psi)	Velocity (ft/s)	Loss (psi)	Velocity (ft/s)	Loss (psi)	Velocity (ft/s)	Loss (psi)	Velocity (ft/s)	Loss (psi)	Velocity (ft/s)	Loss (psi)
1	0.84	0.25	0.53	0.08	0.34	0.03	0.21	0.01	0.16	0.00	0.10	0.00
2	1.68	0.90	1.07	0.30	0.67	0.10	0.42	0.03	0.32	0.02	0.20	0.01
3	2.53	1.90	1.60	0.63	1.01	0.20	0.63	0.06	0.48	0.03	0.31	0.01
4	3.37	3.24	2.14	1.07	1.35	0.35	0.84	0.11	0.64	0.06	0.41	0.02
5	4.21	4.89	2.67	1.61	1.68	0.53	1.05	0.17	0.80	0.09	0.51	0.03
6	5.05	6.86	3.20	2.26	2.02	0.74	1.26	0.23	0.96	0.12	0.61	0.04
7	5.90	9.12	3.74	3.01	2.36	0.98	1.47	0.31	1.12	0.16	0.71	0.05
8	6.74	11.68	4.27	3.86	2.69	1.25	1.68	0.40	1.28	0.20	0.81	0.07
9	7.58	14.53	4.81	4.80	3.03	1.56	1.89	0.49	1.44	0.25	0.92	0.08
10	8.42	17.66	5.34	5.83	3.37	1.90	2.10	0.60	1.60	0.31	1.02	0.10
11	9.26	21.07	5.88	6.96	3.70	2.26	2.31	0.72	1.76	0.37	1.12	0.12
12	10.11	24.75	6.41	8.17	4.04	2.66	2.52	0.84	1.92	0.43	1.22	0.14
14	11.79	32.93	7.48	10.87	4.71	3.53	2.94	1.12	2.24	0.58	1.42	0.19
16	13.48	42.16	8.55	13.92	5.39	4.53	3.36	1.44	2.56	0.74	1.63	0.25
18	15.16	52.44	9.61	17.32	6.06	5.63	3.78	1.79	2.88	0.92	1.83	0.31
20			10.68	21.05	6.73	6.84	4.20	2.17	3.20	1.12	2.03	0.37
22			11.75	25.11	7.40	8.16	4.62	2.59	3.52	1.33	2.24	0.44
24			12.82	29.50	8.08	9.59	5.04	3.04	3.83	1.57	2.44	0.52
26			13.89	34.21	8.75	11.12	5.46	3.53	4.15	1.82	2.64	0.60
28			14.96	39.25	9.42	12.76	5.88	4.05	4.47	2.08	2.85	0.69
30			16.02	44.60	10.10	14.50	6.30	4.60	4.79	2.37	3.05	0.79
35					11.78	19.29	7.35	6.12	5.59	3.15	3.56	1.05
40					13.46	24.70	8.40	7.84	6.39	4.03	4.07	1.34
45					15.15	30.72	9.45	9.75	7.19	5.01	4.58	1.67
50					16.83	37.34	10.50	11.85	7.99	6.09	5.08	2.03
55							11.55	14.13	8.79	7.27	5.59	2.42
60							12.60	16.60	9.59	8.54	6.10	2.85
65							13.65	19.26	10.39	9.91	6.61	3.30
70							14.70	22.09	11.18	11.37	7.12	3.79
75							15.75	25.10	11.98	12.91	7.63	4.30
80							16.80	28.29	12.78	14.55	8.14	4.85
85									13.58	16.28	8.64	5.42
90									14.38	18.10	9.15	6.03
95									15.18	20.01	9.66	6.67
100									15.98	22.00	10.17	7.33
110											11.19	8.74
120											12.20	10.27
130											13.22	11.92
140											14.24	13.67
150											15.25	15.53
160											16.27	17.50
170											11.81	7.76
180											12.51	8.62
190											13.20	9.53
200											13.90	10.48
225											15.64	13.03
250											17.37	15.84
275											11.71	6.07
300											12.88	7.24
325											14.06	8.51
350											15.23	9.87
375											16.40	11.32
400											17.57	12.86
425											11.34	4.27
450											12.05	4.77
475											12.75	5.31
500											13.46	5.87
550											14.17	6.45
600											15.59	7.70

Note: Dark shaded area of chart indicates velocities over 5' per second. Use with caution

The velocity values were derived using the following equation  $V = \frac{0.408 \times Q_{gpm}}{d^2}$

Table are based upon the following Hazen-Williams equation:  $H_f = 0.2083 \times \left(\frac{100}{C}\right)^{1.852} \times \frac{Q^{1.852}}{D^{4.8655}}$  for change in psi per foot of elevation. Pressure loss for uphill elevation and pressure gain for downhill elevation changes.

Resources



PVC Schedule 80 IPS Plastic Pipe

(1120, 1220) C=150

psi Loss per 100 Feet of Pipe (psi/100 ft.)

Sizes 1/2" through 6" Flow 1 through 600 gpm

Table with columns for Nominal Size, Pipe OD, Avg. ID, Avg. Wall, Tolerance, Min. Wall, Flow (gpm), Velocity (ft/s), Loss (psi) for pipe sizes 1/2" through 6".

Note: Dark shaded area of chart indicates velocities over 5' per second. Use with caution

The velocity values were derived using the following equation V = (0.408 \* Q\_gpm) / d^2

Table are based upon the following Hazen-Williams equation: H\_f = 2.0283 \* (100/C)^1.852 \* (Q/1.485)^1.852 for change in psi per foot of elevation. Pressure loss for uphill elevation and pressure gain for downhill elevation changes.





Schedule 40 Standard Steel Pipe

C=100

psi Loss per 100 Feet of Pipe (psi/100 ft.)

Sizes 1/2" through 6" Flow 1 through 600 gpm

Nominal Size	1/2"	3/4"	1"	1 1/4"	1 1/2"	2"	2 1/2"	3"	4"	6"
Pipe OD	0.840	1.050	1.315	1.660	1.900	2.375	2.875	3.500	4.500	6.625
Avg. ID	0.622	0.824	1.049	1.380	1.610	2.067	2.469	3.068	4.026	6.065
Avg. Wall	0.109	0.113	0.133	0.140	0.145	0.154	0.203	0.216	0.237	0.280
Flow (gpm)	Velocity (ft/s)	Loss (psi)	Velocity (ft/s)	Loss (psi)	Velocity (ft/s)	Loss (psi)	Velocity (ft/s)	Loss (psi)	Velocity (ft/s)	Loss (psi)
1	1.05	0.91	0.60	0.23	0.37	0.07	0.21	0.02	0.16	0.01
2	2.11	3.28	1.20	0.84	0.74	0.26	0.43	0.07	0.31	0.03
3	3.16	6.95	1.80	1.77	1.11	0.55	0.64	0.14	0.47	0.07
4	4.22	11.85	2.40	3.02	1.48	0.93	0.86	0.25	0.63	0.12
5	5.27	17.91	3.00	4.56	1.85	1.41	1.07	0.37	0.79	0.18
6	6.33	25.10	3.61	6.39	2.22	1.97	1.29	0.52	0.94	0.25
7	7.38	33.40	4.21	8.50	2.60	2.63	1.50	0.69	1.10	0.33
8	8.44	42.77	4.81	10.88	2.97	3.36	1.71	0.89	1.26	0.42
9	9.49	53.19	5.41	13.54	3.34	4.18	1.93	1.10	1.42	0.52
10	10.55	64.65	6.01	16.45	3.71	5.08	2.14	1.34	1.57	0.63
11	11.60	77.14	6.61	19.63	4.08	6.06	2.36	1.60	1.73	0.75
12	12.65	90.62	7.21	23.06	4.45	7.12	2.57	1.88	1.89	0.89
14			8.41	30.68	5.19	9.48	3.00	2.50	2.20	1.18
16			9.61	39.29	5.93	12.14	3.43	3.20	2.52	1.51
18			10.82	48.87	6.67	15.10	3.86	3.97	2.83	1.88
20			12.02	59.40	7.42	18.35	4.28	4.83	3.15	2.28
22			13.22	70.87	8.16	21.89	4.71	5.76	3.46	2.72
24					8.90	25.72	5.14	6.77	3.78	3.20
26					9.64	29.83	5.57	7.85	4.09	3.71
28					10.38	34.22	6.00	9.01	4.41	4.25
30					11.12	38.88	6.43	10.24	4.72	4.83
35					12.98	51.72	7.50	13.62	5.51	6.43
40							8.57	17.44	6.30	8.24
45							9.64	21.69	7.08	10.25
50							10.71	26.36	7.87	12.45
55							11.78	31.45	8.66	14.86
60							12.85	36.95	9.44	17.45
65							13.93	42.86	10.23	20.24
70									6.21	6.00
75									6.68	6.88
80									7.16	7.82
85									7.64	8.82
90									8.12	9.86
95									8.59	10.96
100									9.07	12.12
110									9.55	13.33
120									10.50	15.90
130									11.46	18.68
140									12.41	21.66
150									13.37	24.85
160									10.04	11.89
170									10.71	13.40
180									11.38	15.00
190									12.05	16.67
200									12.72	18.43
225									13.39	20.26
250									9.75	8.76
275									10.84	10.64
300									11.92	12.70
325									13.00	14.92
350									7.55	3.98
375									8.18	4.61
400									8.81	5.29
425									9.44	6.01
450									10.07	6.77
475									10.70	7.58
500									11.33	8.43
550									11.96	9.31
600									12.59	10.24
										6.10
										1.95

Note: Dark shaded area of chart indicates velocities over 7' per second. Use with caution

The velocity values were derived using the following equation  $V = \frac{0.408 \times Q_{gpm}}{d^2}$

Table are based upon the following Hazen-Williams equation:  $H_f = 0.2083 \times \left(\frac{100}{C}\right)^{1.852} \times \frac{Q^{1.852}}{D^{4.8655}}$  for change in psi per foot of elevation. Pressure loss for uphill elevation and pressure gain for downhill elevation changes.

Type K Copper Water Tube

C=140

psi Loss per 100 Feet of Tube (psi/100 ft.)

Sizes 1/2" through 3" Flow 1 through 600 gpm

Nominal Size	1/2"	5/8"	3/4"	1"	1 1/4"	1 1/2"	2"	2 1/2"	3"	
Pipe OD	0.625	0.750	0.875	1.125	1.375	1.625	2.125	2.625	3.125	
Avg. ID	0.5270	0.652	0.745	0.995	1.245	1.481	1.959	2.435	2.907	
Avg. Wall	0.049	0.049	0.065	0.065	0.065	0.072	0.083	0.095	0.109	
Flow (gpm)	Velocity (ft/s)	Loss (psi)	Velocity (ft/s)	Loss (psi)	Velocity (ft/s)	Loss (psi)	Velocity (ft/s)	Loss (psi)	Velocity (ft/s)	Loss (psi)
1	1.47	1.09	0.96	0.39	0.74	0.20	0.41	0.05	0.26	0.02
2	2.94	3.94	1.92	1.40	1.47	0.73	0.82	0.18	0.53	0.06
3	4.41	8.35	2.88	2.97	2.21	1.55	1.24	0.38	0.79	0.13
4	5.88	14.23	3.84	5.05	2.94	2.64	1.65	0.65	1.05	0.22
5	7.35	21.51	4.80	7.64	3.68	3.99	2.06	0.98	1.32	0.33
6	8.81	30.15	5.76	10.70	4.41	5.59	2.47	1.37	1.58	0.46
7	10.28	40.12	6.72	14.24	5.15	7.44	2.88	1.82	1.84	0.61
8	11.75	51.37	7.68	18.24	5.88	9.53	3.30	2.33	2.11	0.78
9	13.22	63.90	8.64	22.68	6.62	11.85	3.71	2.90	2.37	0.97
10	14.69	77.66	9.60	27.57	7.35	14.41	4.12	3.52	2.63	1.18
11			10.56	32.89	8.09	17.19	4.53	4.21	2.90	1.41
12			11.52	38.64	8.82	20.20	4.95	4.94	3.16	1.66
14			13.44	51.41	10.29	26.87	5.77	6.57	3.69	2.21
16			15.36	65.83	11.76	34.41	6.59	8.42	4.21	2.83
18			17.28	81.88	13.23	42.80	7.42	10.47	4.74	3.52
20					14.70	52.02	8.24	12.72	5.26	4.28
22					16.17	62.06	9.07	15.18	5.79	5.10
24					17.64	72.91	9.89	17.84	6.32	5.99
26							10.71	20.69	6.84	6.95
28							11.54	23.73	7.37	7.97
30							12.36	26.96	7.90	9.06
35							14.42	35.87	9.21	12.05
40							16.48	45.94	10.53	15.43
45									11.84	19.20
50									13.16	23.33
55									14.48	27.84
60									15.79	32.70
65									17.11	37.93
70									18.43	43.51
75									13.95	21.24
80									14.88	23.94
85									15.81	26.79
90									16.74	29.78
95									17.67	32.91
100									18.60	36.19
110									11.69	11.07
120									12.76	13.01
130									13.82	15.08
140									14.88	17.30
150									15.95	19.66
160									17.01	22.16
170									18.07	24.79
180									12.39	9.56
190									13.07	10.57
200									13.76	11.62
225									15.48	14.46
250									17.20	17.57
275									18.92	20.96
300										14.48
325										15.69
350										16.90
375										18.11
400										19.31
425										
450										
475										
500										
550										

Note: Dark shaded area of chart indicates velocities over 7' per second. Use with caution

The velocity values were derived using the following equation  $V = \frac{0.408 \times Q_{gpm}}{d^2}$

Table are based upon the following Hazen-Williams equation:  $H_f = 0.2083 \times \left(\frac{100}{C}\right)^{1.852} \times \frac{Q^{1.852}}{D^{4.8655}}$  for change in psi per foot of elevation. Pressure loss for uphill elevation and pressure gain for downhill elevation changes.

Index

¼" Barb Transfer Fittings . . . . .	144	RD1800™ Series Spray Heads . . . . .	9
¼" Landscape Dripline . . . . .	143	Retrofit Pressure Regulators . . . . .	155
¼" Self-Piercing Barb Connector . . . . .	114	Riser Stake-Threaded . . . . .	124
¼" Tubing Stake with Cap . . . . .	123	ROTOR TOOL . . . . .	42
½" FPT x Barb Grey Transfer Fitting . . . . .	114	Round Catch Basins . . . . .	179
6 Outlet Manifold - EMT-6Xeri . . . . .	114	RSD-BEx / RSD-CEx . . . . .	96
10-32 Thread Adapter . . . . .	124	R-VAN Nozzles . . . . .	16
12" PolyFlex Riser . . . . .	124	RWS (Root Watering System) . . . . .	125
300-BPES Brass Valves . . . . .	70	SA Series . . . . .	12
1300A-F . . . . .	35	SB Series Spiral Barb Fittings . . . . .	13
1400 Series . . . . .	35	SH Series . . . . .	74
1800°-EXT . . . . .	10	SiteControl . . . . .	110
1800° NP Cover . . . . .	10	SiteControl Hardware . . . . .	104
1800 PCS . . . . .	10	SMRT-Y Soil Moisture Sensor Kit . . . . .	98
1800°-SAM, 1800°-PRS, 1800°-SAM-PRS, 1800°-SAM-P45 Series . . . . .	8	Spray-to-Drip Retrofit Kit . . . . .	158
1800° Series . . . . .	7	Spread Spectrum Radio . . . . .	108
1800 Xeri-Bubbler Adapter . . . . .	124	SPX Series Swing Pipe . . . . .	13
2045A Maxi-Paw™ and 2045-PJ Maxi-Bird™ . . . . .	55	SQ Series, Square Pattern Nozzles . . . . .	34
3500 Series . . . . .	37	Square Basin Kits . . . . .	181
5000 Series . . . . .	39	Square Catch Basins . . . . .	180
5000 Series MPR Nozzles . . . . .	45	Square Low-Profile Basins . . . . .	181
8005 Series . . . . .	51	Subterranean Emitter Box . . . . .	144
Air/Vacuum Relief Valve Kit . . . . .	140	TBOS-II™ . . . . .	91
Anemometer Wind Sensor . . . . .	108	Technical Support . . . . .	186
ASVF Series . . . . .	61	TSJ/TSJ-PRS Series . . . . .	57
Basin Adapters and Accessories . . . . .	182	Tubing Cutter . . . . .	144
Centrifugal Sand Separator . . . . .	172	Tubing Goof Plug . . . . .	144
CLP Series . . . . .	161	Twist Lock Fittings . . . . .	137
Commercial Valve Wire Sizing Procedure . . . . .	77	UNI-Spray™ Series . . . . .	6
Controller Pedestals . . . . .	89	Universal ¼" Tubing Stake . . . . .	123
Control Zone Kits . . . . .	146	Universal Square Grates . . . . .	179
Control Zone Kit Selection Guide . . . . .	145	U-Series Nozzles . . . . .	23
CS Series . . . . .	172	Valve Keys . . . . .	74
DB Series Wire Connector . . . . .	71	VAN Series Nozzles . . . . .	26
Diffuser Bug Cap . . . . .	123	VB Series Valve Boxes . . . . .	76
Disc Filters . . . . .	173	Wide Flow Commercial Control Zone Kit with Pressure Regulating, Basket Filter . . . . .	150
DPU-210 Decoder Programming Unit . . . . .	90	Wide Flow Commercial Control Zone Kit with Scrubber Valve & Pressure Regulating, Basket Filter . . . . .	151
Drainage Pop-Up Valves . . . . .	182	Worry-Free Warranties . . . . .	185
Drip System Operation Indicator . . . . .	140	WR2 Series Wireless Rain + Freeze Sensors . . . . .	97
DV / DVF Series . . . . .	59	WS-PRO Weather Stations . . . . .	107
Easy Fit Compression Fitting System . . . . .	139	XBS - Black Stripe Tubing . . . . .	142
EFB-CP Series Brass Valves . . . . .	69	Xeri-Bird™ 8-Outlet Emission Device . . . . .	115
E+ Series and E0+ Series Electric Suction Scanning Screen Filter . . . . .	170	Xeri-Bubblers™ . . . . .	121
ESP-LX Basic Controller . . . . .	85	Xeri-Bug™ Emitters . . . . .	112
ESP-LXD Decoder Controller . . . . .	87	Xeriman™ Tool . . . . .	112
ESP-LXME/F Controllers . . . . .	86	Xeri-Pop™ Micro-Spray . . . . .	120
ESP-Me Series Controllers . . . . .	83	Xeri-Sprays™ and Misters . . . . .	122
ESP-SMTe Smart Modular Control System . . . . .	84	Xeri-Spray™ 360° True Spray . . . . .	122
ESP-TM2 Series Controller . . . . .	82	XFCV Dripline with Check Valve . . . . .	130
Extra Durable Drip System Design Guide . . . . .	159	XFD On-Surface Dripline . . . . .	128
Falcon® 6504 Series . . . . .	47	XF Dripline Insert Fittings . . . . .	138
FD-TURF Two-Wire Decoders . . . . .	89	XF Insertion Tool . . . . .	140
Flow Sensors and Transmitters . . . . .	95	XFS-CV Dripline with Heavy-Duty Check Valve . . . . .	134
FMD Series Landscape Water Meters . . . . .	94	XF Series Blank Tubing . . . . .	141
Full-Circle Rotary Nozzles . . . . .	19	XF Series Dripline Design, Installation and Maintenance Guide . . . . .	159
Galvanized Tie-Down Stake . . . . .	144	XFS Sub-Surface Dripline with Copper Shield™ Technology . . . . .	132
G-Series Hydraulic Suction Scanning Screen Filter . . . . .	168	XQ ¼" Distribution Tubing . . . . .	143
HDF Series . . . . .	173	XT-700 Distribution Tubing . . . . .	141
HE-VAN Series Nozzles . . . . .	20		
High Flow Commercial Control Zone Kit with 2 Pressure Regulating, Basket Filters . . . . .	152		
Holdup Tool with Bubble Level . . . . .	42		
How to Use This Catalog . . . . .	186		
HV Series . . . . .	62		
Inline Pressure Regulators . . . . .	155		
Inline RBY Filter . . . . .	154		
Internet Connected Water Meters (ICWM) . . . . .	92		
IQ NCC Network Communication Cartridge . . . . .	102		
IQ™ v3.0 Central Control Software . . . . .	101		
I+ Series Hydraulic Suction Scanning Screen Filter . . . . .	169		
Landscape Drip Application Guide . . . . .	159		
Landscape Drip Conversion Guide . . . . .	159		
Landscape Drip System Overview . . . . .	110		
Large-Capacity Filters . . . . .	157		
LNK WiFi Module . . . . .	81		
Locking Cover Key . . . . .	74		
Low Flow Control Zone Kits with Anti-Siphon Valve and PR Filter . . . . .	148		
Low Flow Control Zone Kits with PR Filter . . . . .	147		
Low Flow Valves . . . . .	153		
Low Profile Pump Stations – LP Series . . . . .	163		
Low to Medium Flow Pump Stations – D-Series . . . . .	164		
Main Irrigation Pump Stations . . . . .	166		
Maxicom™ Hardware . . . . .	106		
Medium Flow Control Zone Kits with Anti-Siphon Valve and PR Filter . . . . .	148		
Medium Flow Control Zone Kits with PR Filter . . . . .	149		
Medium Flow Pump Station . . . . .	165		
MPR Spray Nozzles . . . . .	30		
Multi-Outlet Xeri-Bug™ . . . . .	114		
Online Control Zone Kit Selection Guide . . . . .	145		
PA . . . . .	10		
PA-8S-PRS . . . . .	10		
PA-80 . . . . .	10		
PBCLXD Programming Backup Cartridge for ESP-LXD . . . . .	88		
PC Diffuser Caps . . . . .	117, 123		
PEB / PESB Series . . . . .	65		
PESB-R Series Valves . . . . .	67		
PGA Series . . . . .	63		
Pigtail . . . . .	88		
Plastic Round Grates . . . . .	177		
Plastic Square Grates . . . . .	178		
PolyFlex Riser and Adapter Assemblies . . . . .	124		
PolyFlex Riser and Stake Assembly . . . . .	124		
Pressure-Compensating Modules . . . . .	35, 116		
Pressure Loss Reference Charts . . . . .	186		
Pressure Regulating, and Quick-Check Pressure Regulating Basket Filters . . . . .	156		
Pressure-Regulating Filter (RBY) . . . . .	154		
PRS-Dial . . . . .	72		
PSS Series Self-Cleaning Pump Suction Screen . . . . .	171		
Pump Manager with SmartPump™ . . . . .	166		
Pump Start Relays . . . . .	167		
Purple Valve Handle Assembly . . . . .	74		
PVB Professional Series Valve Boxes . . . . .	75		
QF Dripline Header . . . . .	136		
Quick-Check Basket Filter . . . . .	155		
Quick-Coupling Valves . . . . .	73		
Rain Bird Filtration Controller . . . . .	174		
Rain Bird® LC Series . . . . .	162		
Rain Bird Online Resources and Contacts List . . . . .	183		
Rain Bird Rewards . . . . .	185		
Rain Bird Training Services . . . . .	184		
Rain Curtain™ Nozzle Cross Reference Guide . . . . .	54		

## The Intelligent Use of Water.™

LEADERSHIP • EDUCATION • PARTNERSHIPS • PRODUCTS

---

At Rain Bird, we believe it is our responsibility to develop products and technologies that use water efficiently. Our commitment also extends to education, training and services for our industry and our communities.

The need to conserve water has never been greater. We want to do even more, and with your help, we can. Visit [www.rainbird.com](http://www.rainbird.com) for more information about The Intelligent Use of Water.™



**Rain Bird Corporation**  
6991 E. Southpoint Road  
Tucson, AZ 85756  
Phone: (520) 741-6100  
Fax: (520) 741-6522

**Rain Bird Technical Services**  
(800) RAINBIRD (1-800-724-6247)  
(U.S. and Canada)

**Rain Bird Corporation**  
970 West Sierra Madre Avenue  
Azusa, CA 91702  
Phone: (626) 812-3400  
Fax: (626) 812-3411

[www.rainbird.com](http://www.rainbird.com)

**Rain Bird International, Inc.**  
1000 West Sierra Madre  
Azusa, CA 91702  
Phone: (626) 963-9311  
Fax: (626) 852-7343