

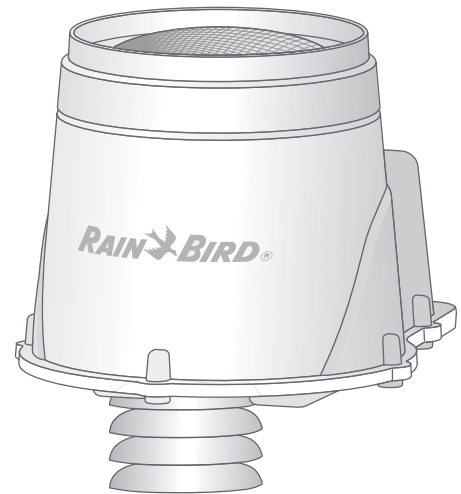

# ***ESP-SMTe Smart Modular Controller Quick-Start Installation & Setup Guide***

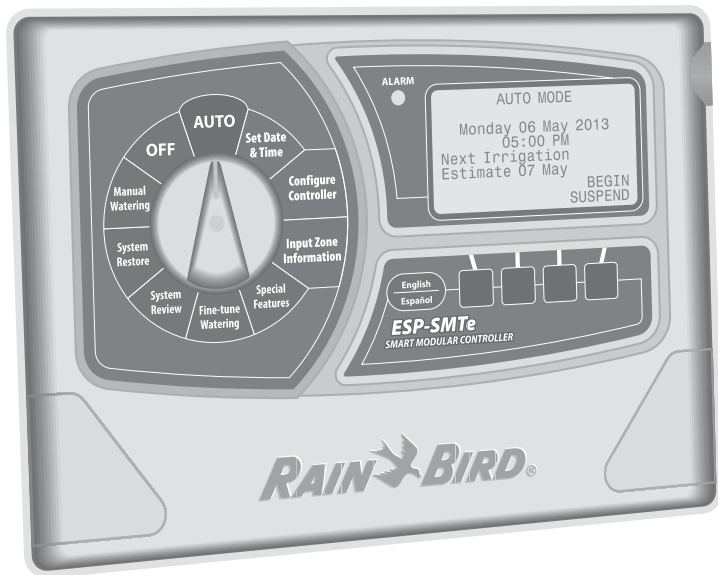

# Welcome To The Rain Bird ESP-SMTe Smart Control System

The Rain Bird ESP-SMTe “Smart” Modular Control System has many advanced features based on scientific agronomic principles. It is designed for you to easily and conveniently keep your client’s landscape healthy and vibrant by optimizing the irrigation schedule to match the plant water needs associated with changing weather conditions.

You are about to install a control system that many of our field test participants commented was just what they need to irrigate efficiently and save water. They also stated that this controller is much easier and faster to program than any other controller they have used.

To leverage the water savings potential of the ESP-SMTe control system, it is important that you become familiar with both the basic as well as advanced capabilities of the controller. If you would like to better understand Plant-Soil-Water relationship principles or learn more about how to maximize the water savings and your profits with the ESP-SMTe Smart Control System, we offer a free, comprehensive on-line tutorial program. To learn more, visit the Rain Bird website... [www.rainbird.com](http://www.rainbird.com)

**Thank you for doing your part to conserve our most precious natural resource... WATER!**

## Box Contents and Installation Tools

### Check Box Contents

1. ESP-SMTe Modular Controller
2. Door Keys (Outdoor model only)
3. Grounded Power Supply (Indoor model only)
4. Controller Mounting Hardware (Four #8 screws and wire nuts)
5. Mounting Template
6. ESP-SMTe Homeowner’s Guide
7. Site Profile Chart
8. Installation & Quick Setup Poster
9. SMTe Weather Sensor
10. Weather Sensor Debris Screen
11. Weather Sensor Mounting Bracket
12. Mounting Bracket Hardware (Four Phillips head screws + finger screw for mounting sensor to bracket)
13. Sensor Wire - 25 feet of 20-2 UV rated wire (not rated for direct burial)

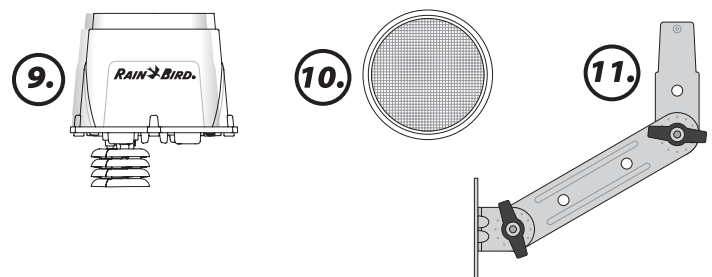
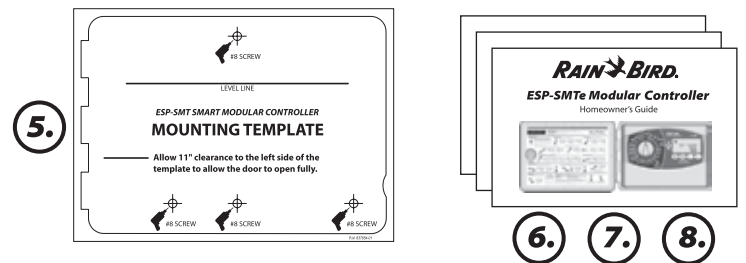
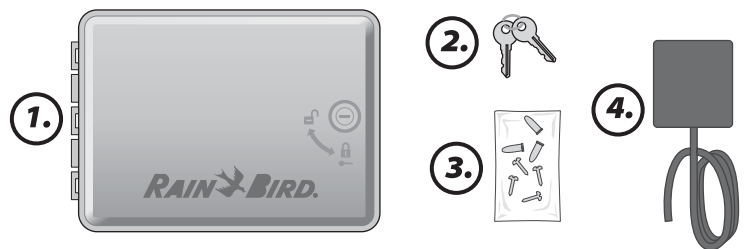

### Installation Tools (not provided)

- Marking Pencil
- Flathead screwdriver
- Level
- Wire Stripper
- Drill and drill bit
- Hammer
- Philips screwdriver (#1, #2, #3 tip)

# Controller Installation

## Mount Controller

1. Open the door of the controller and swing it to the left. If desired, remove it from the hinges by applying pressure upward and outward until the door unsnaps from the hinges.
2. Pull open the front panel, swing it to the left and disconnect the ribbon cable by gently pulling the connector out of the socket.

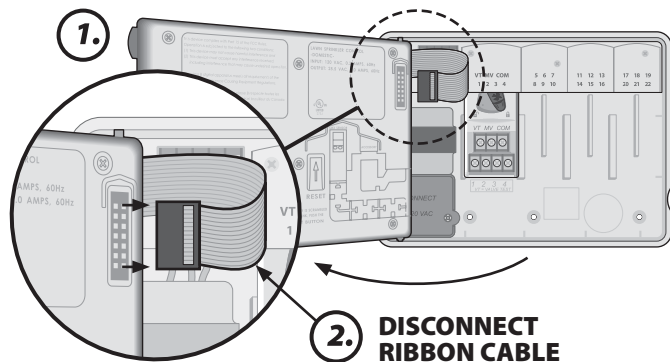

3. Remove the front panel by gently pulling the panel upward and sliding the bottom corner pin out of the lower pin-hole.

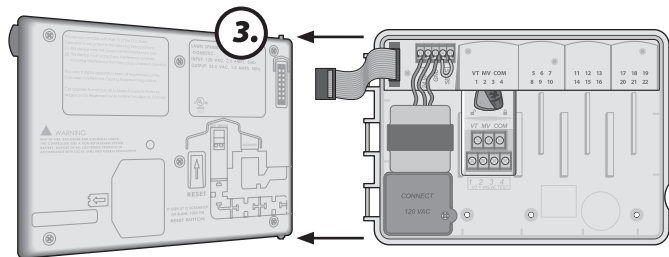

4. If a knockout needs to be removed, place the blade of the screwdriver into the groove around the knockout and tap it with a hammer.

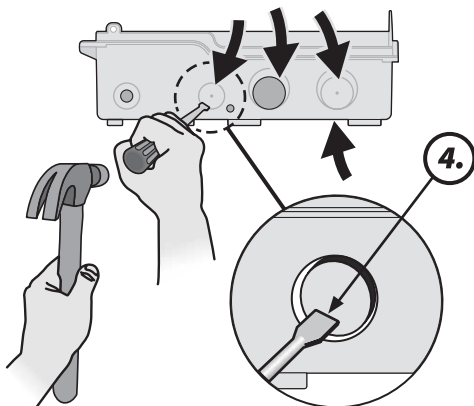

5. Mark the four screw locations on the mounting surface with a marking pencil.
6. Drill holes in the mounting surface, installing wall anchors if necessary.
7. Drive a mounting screw for the top anchor into the wall. Leave an 1/8 inch gap between the screw head and the wall surface.
8. Locate the keyhole slot on back of the controller unit and hang the unit securely on the mounting screw.

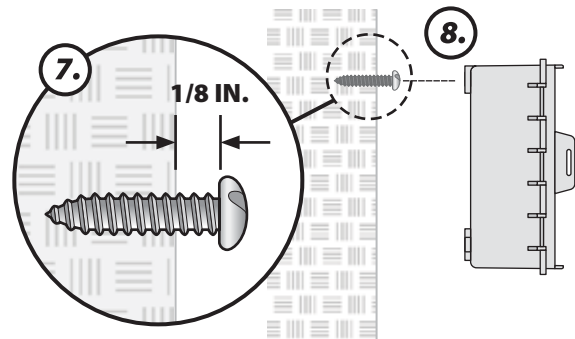

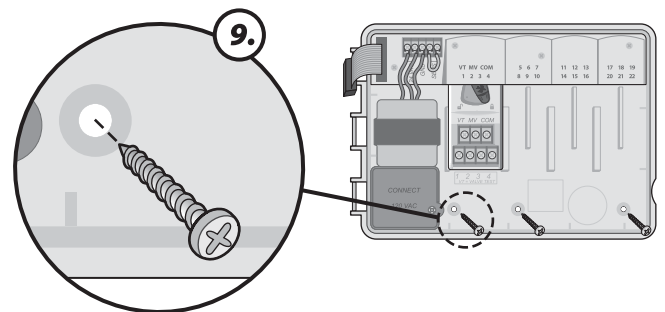

9. Drive three additional mounting screws through the open holes inside the controller and into the wall. Verify that the unit is fastened securely to the wall.



# Connect Power

## Indoor Model:

 **WARNING:** DO NOT plug in the transformer until you have completed and checked all wiring connections.

 **WARNING:** All electrical connections and wiring runs must comply with local building codes.

1. Route the transformer power cord through the conduit opening at the bottom left of the unit. Knot the cable/cord inside the controller cabinet to prevent it from being pulled out.

 **CAUTION:** Do not route the power cord through the field wire opening at the bottom right of the unit.

2. Connect the two power wires on the cord to the two 24VAC terminal connections on the controller.

3. Connect the ground wire on the cord to the GND terminal.

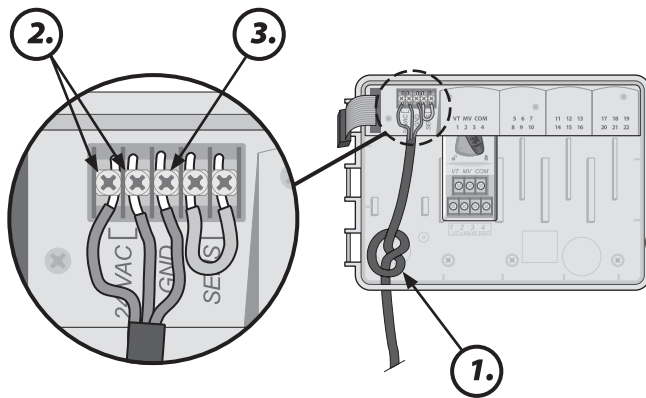



4. Plug the transformer into the electrical outlet.

## Outdoor Model:

The ESP-SMTe outdoor controller has an internal transformer that reduces supply voltage from 120 VAC to 24 VAC. You will need to connect power supply wires to the transformer's three wires. (Line, Neutral, Ground).

 **WARNING:** Electric shock can cause severe injury or death. Make sure power supply is turned OFF before connecting power wires.

 **WARNING:** DO NOT connect power until you have completed and checked all wiring connections.

 **WARNING:** All electrical connections and wiring runs must comply with local building codes. Some building codes require that only a licensed or certified electrician can make the power connections. Please check with your local building code for guidance.

1. Locate the transformer wiring compartment in the lower left corner of the controller unit. Use a screwdriver to remove the cover and expose the transformer connection wires.

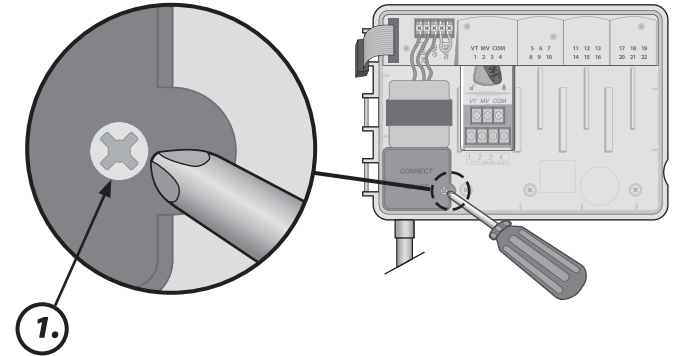

2. Route the three external power source wires through the conduit opening at the bottom of the unit and into the wiring compartment.

 **NOTE:** Attach a 1/2 inch conduit to the unit below the transformer if desired.

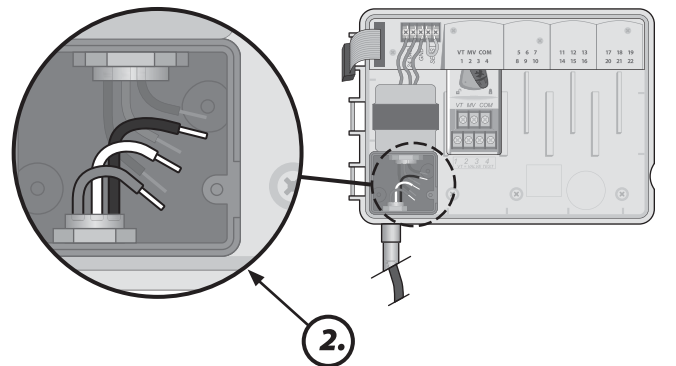

### Power Wiring Connections, 120 VAC (US)

Black supply wire (hot) to the black transformer wire

White supply wire (neutral) to the white transformer wire

Green supply wire (ground) to the green transformer wire

3. Using the provided wire nuts, connect the external power source wires (two power and one ground) to the transformer connection wires inside the wiring compartment.

 **WARNING:** Ground wire must be connected to provide electrical surge protection.

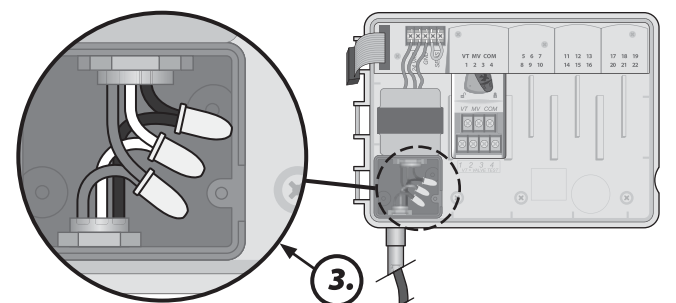

- Verify that all wiring connections are secure, then replace the wiring compartment cover and secure it with the screw.

**WARNING:** DO NOT turn on power until you have completed and checked all wiring connections and replaced the cover.

### Connect Field Wiring to Controller

- Route the valve wires through a knock-out opening at the bottom or back of the unit.

**WARNING:** Do not route the valve wires through the same opening as the power wiring.

- Connect the common wire from each valve to the COMMON (COM) terminal on the base module.
- Connect the control (or valve) wire from each valve to the terminal on the base module or Station Module that corresponds to the desired station number (1-22).

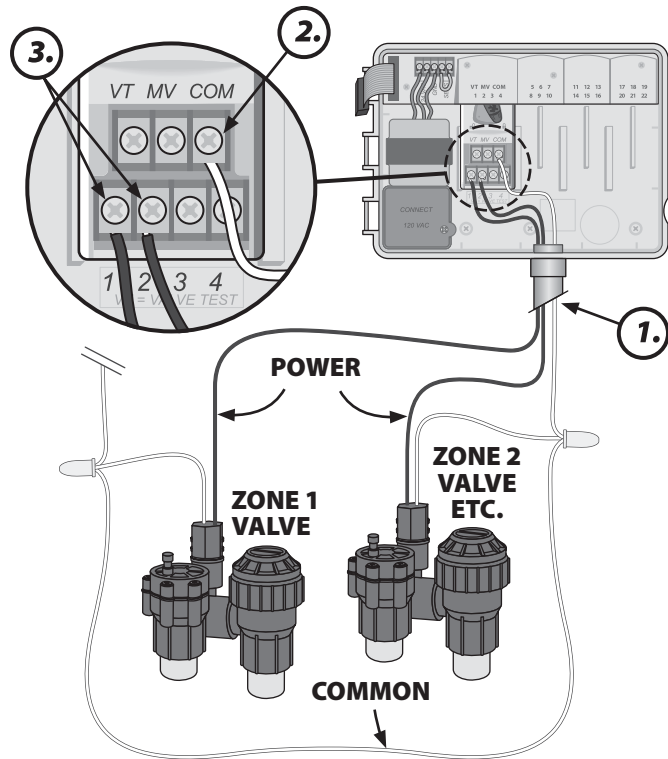

### Connect Weather Sensor Wire to Controller

Begin by running 18-2 AWG, UV rated wire from sensor to controller (200 ft. max.)

**NOTE:** 25 feet of 18-2 AWG, UV rated wire is provided.

- Strip wire insulation approx 3/8" and insert leads into connector located on back of front panel (polarity not important).
- Route the two wires through the provided channel and out through one of the knockouts, located in the bottom of the controller cabinet.

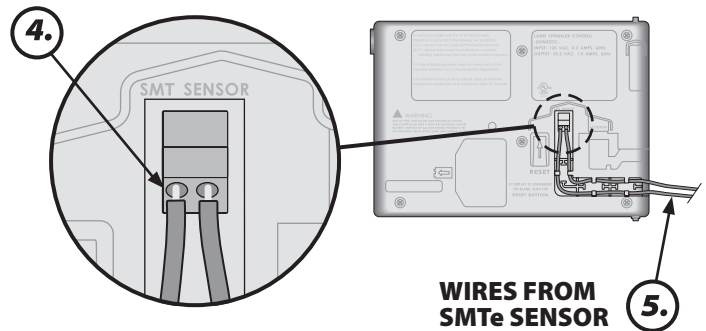

### Complete Installation

Reinstall the front panel and reconnect the ribbon cable. Then reinstall the outer door if necessary.

# SMTe Weather Sensor Mounting Options

## Do's

- Mount the weather sensor at least six feet above grade.
- Ensure that sensor is free from obstructions to allow for collection and accurate measurement of rainfall.
- Sensor does not require direct sun to work correctly provided any shade or other obstruction does not block rainfall.

## Don't's

- Do NOT install sensor in a location where spray from a sprinkler will collect in the sensor.
- Do NOT install the sensor where rainfall will be reduced or blocked from entering the sensor funnel.
- Do NOT install the sensor where it will be impractical to service – the rain sensor may require cleaning depending on the amount of leaves, dust, etc that may collect in the debris screen, funnel, or tipping bucket rain sensor.

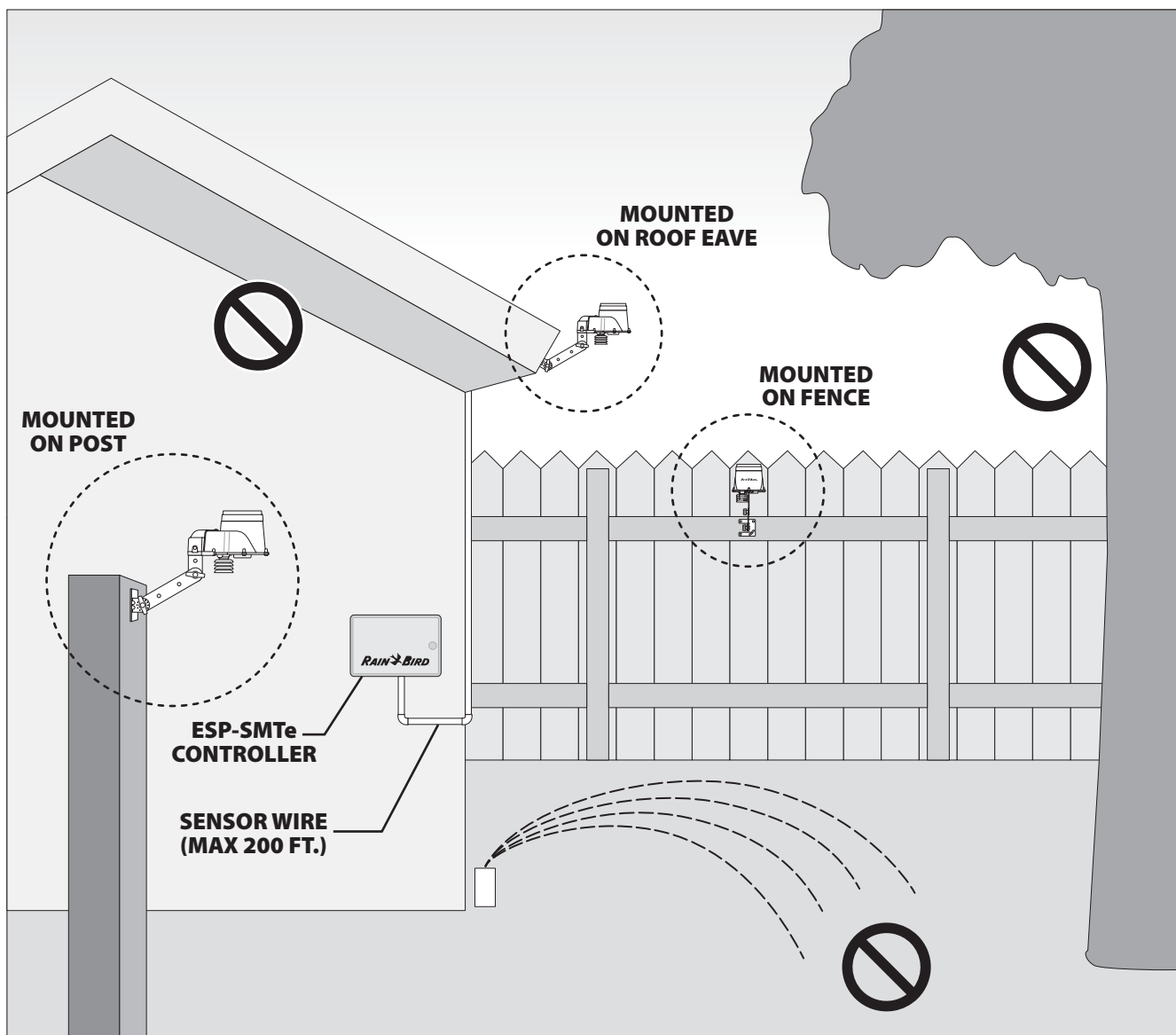

# Weather Sensor Installation

**Begin by running the communication wire to the location where the sensor will be mounted.**

1. Place the mounting bracket base assembly against a mounting surface that permits the top of the mounting bracket to be adjusted to vertical. Drive a screw into the upper left hole of the base (do not tighten completely).
2. Drive a second screw into the middle area of the adjustment slot, located on the lower right corner of the mounting base.
3. Level the mounting base and hold it in place, then tighten the screw in the adjustment slot.
4. Tighten the upper left screw, then drive the two remaining screws into the mounting base, securing it to the mounting surface.
5. Feed the communication wire(s) through the three holes in the mounting arm, providing "strain-relief" for the wires. Leave enough extra wire at the top end so the sensor pod can easily be installed and removed.
6. Loosen the captured-screw of the wiring compartment cover to expose the sensor housing and green wiring connector within.
7. Strip the two wire leads 1/4" and insert into the connectors (polarity is not important).
8. If AC power is available, the green LED will blink. Once communication is established between the sensor and controller, the LED will light solid.
9. Re-attach the wiring compartment cover and route the wire through the two openings. Then re-tighten the captured screw to secure the cover.
10. Mount the sensor housing assembly to the top of the mounting arm. Align the mounting hole on the bracket with the arm and tighten using the provided thumb-screw
11. Adjust each of the mounting arms to assure that the top of the sensor is secured and level.
12. Press the sensor debris cover onto the top of the sensor.

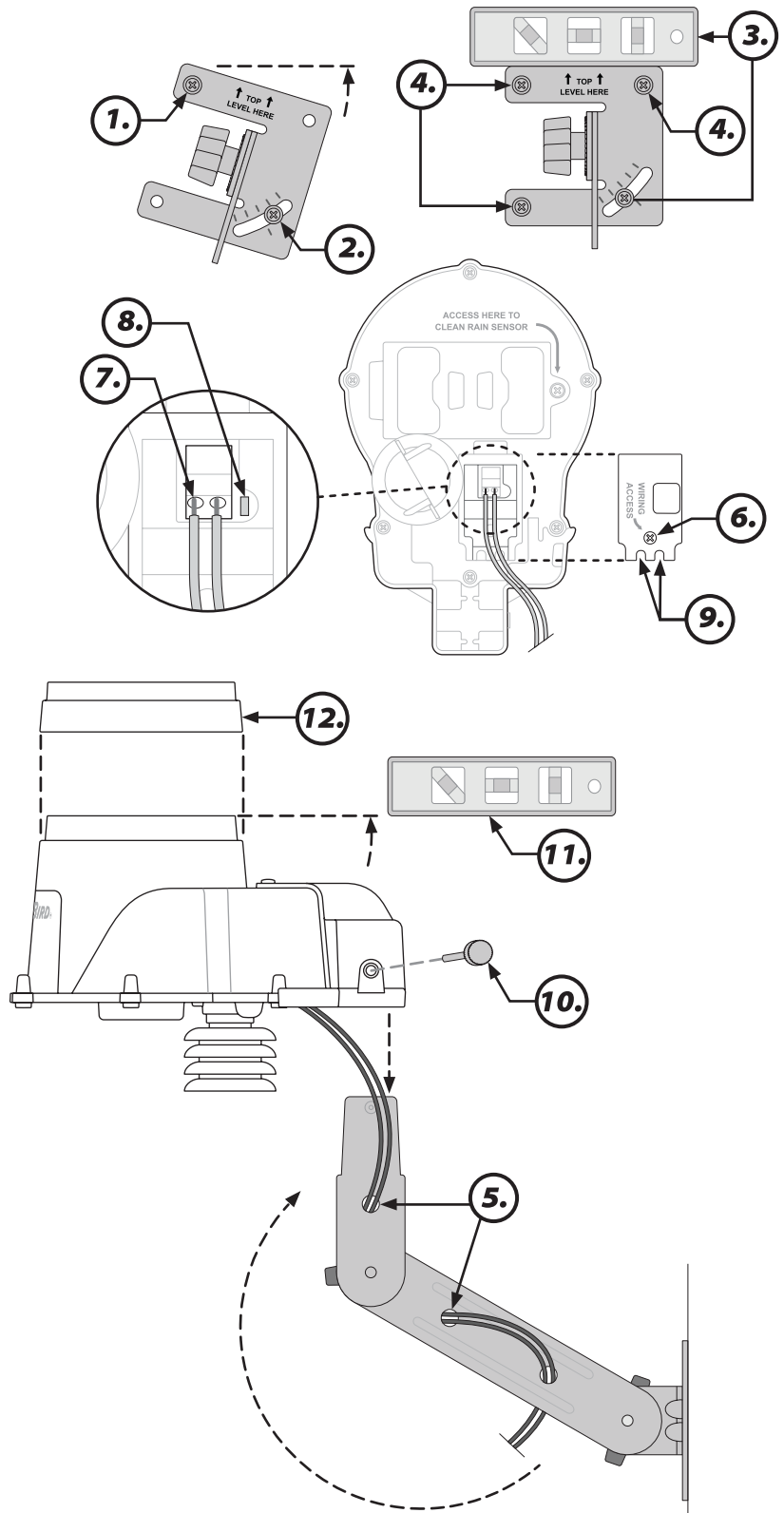

# Initial Controller Setup

## Controls and Indicators

### Key Operational Features of the ESP-SMTe Controller:

#### Controller Features

##### AUTO

Watering occurs automatically

##### OFF

Cancels all irrigation after 3 seconds

##### Manual Watering

Permits user to start watering immediately

##### System Restore

Set initial soil moisture, restore contractor defaults, or restore factory defaults

##### System Review

View system settings, weather information, estimated schedules 3 weeks in advance, and event logs

#### Programming Dial

#### Initial Controller & Zone Set-Up Dial Positions

#### Alarm Light Illuminates

When conditions prevent watering

#### Large Back-Lit Dot-Matrix Display

#### Programming Buttons

Press and Hold to accelerate settings

#### English/Spanish Button

For easy switching of display language

#### Remotely Programmable

Using 9V battery

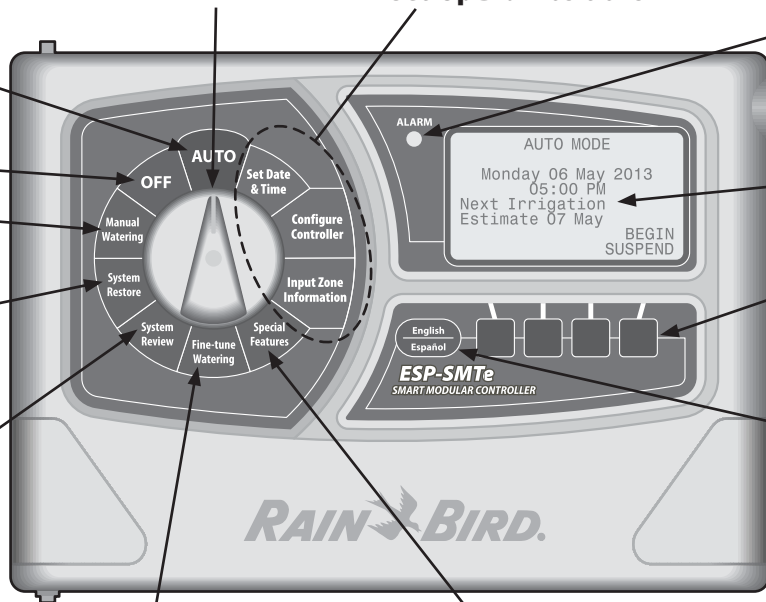

#### Fine-Tune Watering

Adjust run times by zone for weather based zones

#### Special Features

Select advanced irrigation features and controller setup options, such as block irrigation on days of special events

### ESP-SMTe Controller Front Panel

#### Remote Programming

The front panel can be removed from the controller and programmed remotely using a 9 volt battery.

1. Remove the front panel and install a 9V battery in the battery compartment.



**NOTE:** Program information is stored in nonvolatile memory so it is never lost if the front panel loses power.



**NOTE:** A battery is not needed for normal operation.

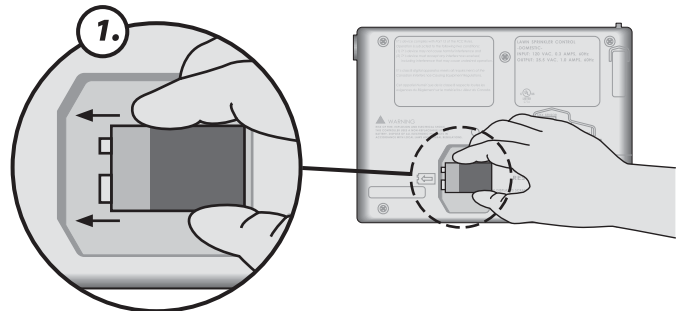

## Technical Support

For assistance, please contact Rain Bird at **1-800-247-3782**. For additional copies of the user documentation, including Spanish and French language support, please visit our website at [www.rainbird.com/esp-smte](http://www.rainbird.com/esp-smte)



# Set Date & Time

Turn the dial to



**Set the current calendar Date and Time of day.**

1. Turn the dial to Set Date & Time.
2. Press – or + to set the MONTH; then press NEXT.
3. Press – or + to set the DAY; then press NEXT.
4. Press – or + to set the YEAR; then press NEXT.
5. Press – or + to set the HOUR (ensure that the AM/ PM setting is correct); then press NEXT.
6. Press – or + to set the MINUTES.

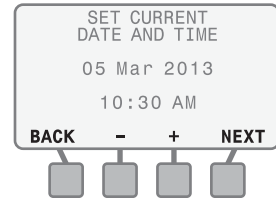

# Configure Controller

Turn the dial to



**Enter site location data and setup irrigation schedules.**

1. Select

ENTER SITE ZIP CODE

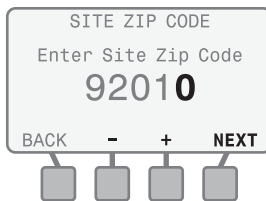

2. Select ALLOWED WATER DAYS

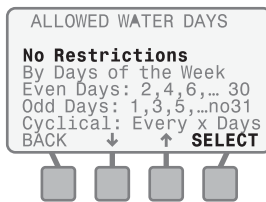

3. Select BLOCK WATER DAY (if desired)

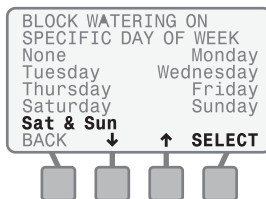

4. Enter

1st Watering Time

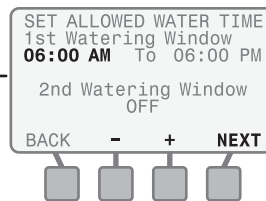

5. Enter

2nd Watering Time

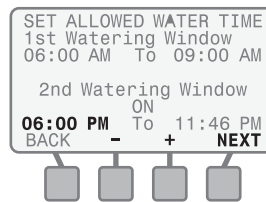

6. Enter

Daily Watering Window



7. Enter

RAIN SHUTOFF

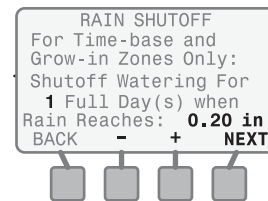

8. Review Info (Press BACK or MORE)

# Input Zone Information

Turn the dial to

Enter site information for each zone.

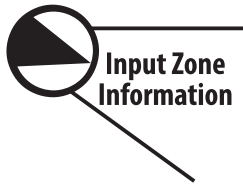

1. Select ZONE SETUP WIZARD method



2. Select ZONE #

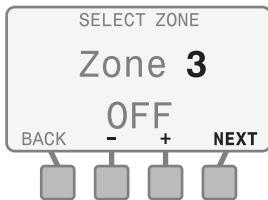

3. ENABLE zone

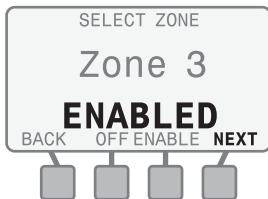

4. Select SOIL TYPE

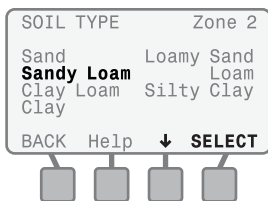

5. Select ZONE TYPE

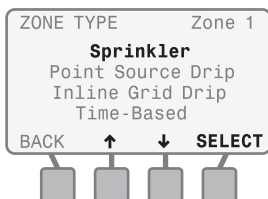

6. Select WATER WINDOW

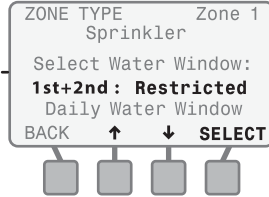

7. Select SPRINKLER TYPE

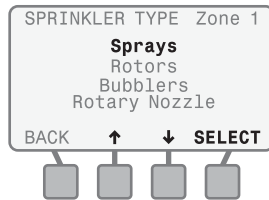

8. Enter NET APPLICATION RATE

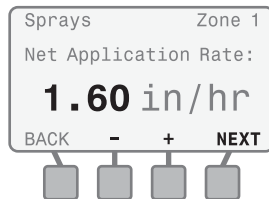

9. Enter CYCLE/SOAK

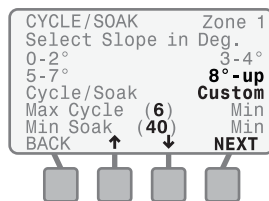

10. Select PLANT TYPE

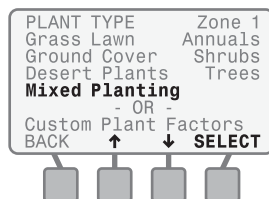

11. Enter PLANT WATER NEED (non grass)

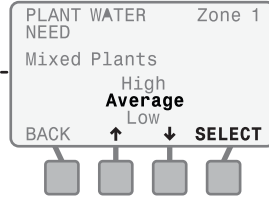

12. Enter ROOT DEPTH

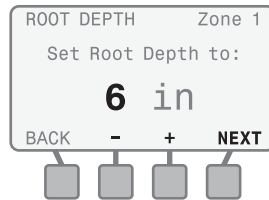

13. Enter PLANT DENSITY (non grass)

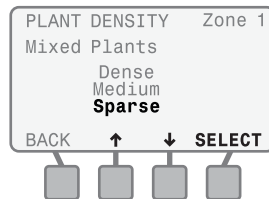

14. Select SHADE FACTOR (all plants)

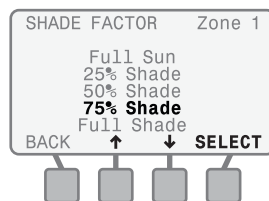

15. Enter RE-FILL POINT (if needed)

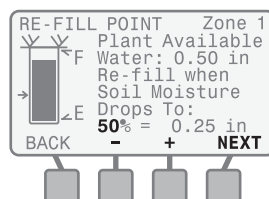

16. Enter PLANT MATURITY (all plants)

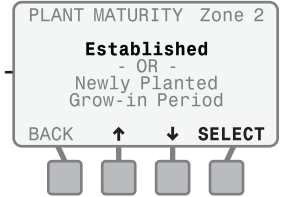

17. Enter NEWLY PLANTED schedule (if needed)

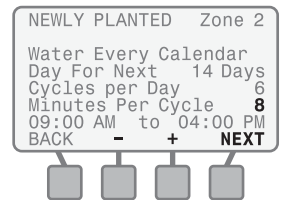

18. Review Info and select NEXT ACTION

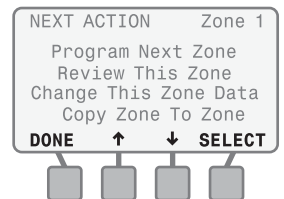

Repeat process for all desired Zones

P/N: 638584-01  
18FE13