



## ESP-LXD 2-Wire Decoder System Design Guide





# Contents

<b>Decoder Overview</b> .....	<b>3</b>	FD-102: One address – controlling two valves simultaneously .....	13
<b>Advantages of a Decoder System</b> .....	<b>4</b>	FD-202: Two addresses – each controlling two valves simultaneously .....	14
Aesthetics .....	4	FD-401: Four addresses – each controlling one valve .....	15
Designed for Protection from the Elements .....	4	FD-601 – Six addresses – each controlling one valve .....	16
Vandal Resistant .....	4	Field Decoders – Grey vs. Black .....	17
Flexible Installation and Simple Expansion .....	4	Sensor Decoder – SD-211 (TURF) .....	17
<b>Layout</b> .....	<b>5</b>	Lightning Surge Protector – LSP-1 (Yellow) .....	18
Two-Wire Path Layout .....	5	<b>Wires &amp; Splices</b> .....	<b>18</b>
Star Configuration .....	6	MAXI Wire .....	18
Loop Configuration .....	7	Wire Splices .....	18
Decoder to Solenoid Layout .....	8	<b>Grounding &amp; Surge Protection Specifications</b> .....	<b>19</b>
<b>Valve Types</b> .....	<b>8</b>	ESP-LXD Decoder Controller .....	19
<b>ESP-LXD Decoder Controller Specifications</b> .....	<b>9</b>	ESPLXD-M50 Decoder Control Module .....	19
ESP-LXD Decoder Controller .....	9	LSP-1 Lightning Surge Protector .....	20
ESPLXD-M50 Decoder Module .....	9	SD-211 Sensor Decoder .....	20
ESPLXD-SM75 Expansion Module .....	9	FD-401 and FD-601 Field Decoder .....	20
Built-in Flow Management .....	9	<b>Appendix</b> .....	<b>21</b>
FS-Series Flow Sensors .....	9	Flow Management .....	21
SimulStations™ .....	9	Flow Sensor Sizing .....	23
Weather Sensor(s) .....	10	Flow Sensor Installation .....	24
PBC-LXD Programming Backup Cartridge .....	10	Low Flow Bypass Design .....	24
ETC-LX ET Manager™ Cartridge .....	10	Pump Start Relay .....	25
IQ Compatible .....	10	SimulStations™ .....	25
Metal Cabinet & Pedestal .....	11	<b>Rain Bird ESP-LXD Decoder Controller Specification Checklist</b> .....	<b>26</b>
<b>Decoder Types &amp; Specifications</b> .....	<b>12</b>		
Field Decoders (TURF or GOLF) .....	12		
FD-101: One address – controlling one valve .....	13		

---

## Rain Bird Spec Hotline

Please call the Rain Bird Spec Hotline number at 800-458-3005 (U.S. and Canada) for assistance with the information contained in this guide. You may also send an email with questions to: SpecHotline@rainbird.com.

## Details and Specifications

CAD Details for controller components for the Rain Bird ESPLXD Decoder System are located at <http://www.rainbird.com/landscape/resources/CAD/CAD-Controllers.htm>

Details for the Decoders and components, including flow sensors, can be found at <http://www.rainbird.com/landscape/resources/CAD/CAD-Decoders.htm>. Written Specifications for the products can be found at [http://www.rainbird.com/documents/turf/RainBirdSpecifications\\_Controllers.doc](http://www.rainbird.com/documents/turf/RainBirdSpecifications_Controllers.doc)

Copyright © 2012 Rain Bird Services Corporation. All rights reserved. No part of these materials may be reproduced by any means, nor translated into machine language, without written permission of the publisher.

# Decoder Overview

A Rain Bird ESP-LXD Decoder Controller controls large irrigation systems comparable to the traditionally wired irrigation controller. The difference is decoders directly power the solenoids from the 2-wire path.

A Rain Bird ESP-LXD Decoder Controller is programmed similar to a traditional wired controller. The difference is decoder addresses must be programmed into the controller. The decoder address represents a control valve for an irrigation zone, flow or weather sensor, master valve or pump start relay. As irrigation programs execute, commands are communicated to the decoders in the field. This communication is carried through a low-voltage two-wire communication path to the numerous decoders located throughout the site. The decoders respond to a three, four or five-digit address. The decoders will directly activate the solenoids on the valves.

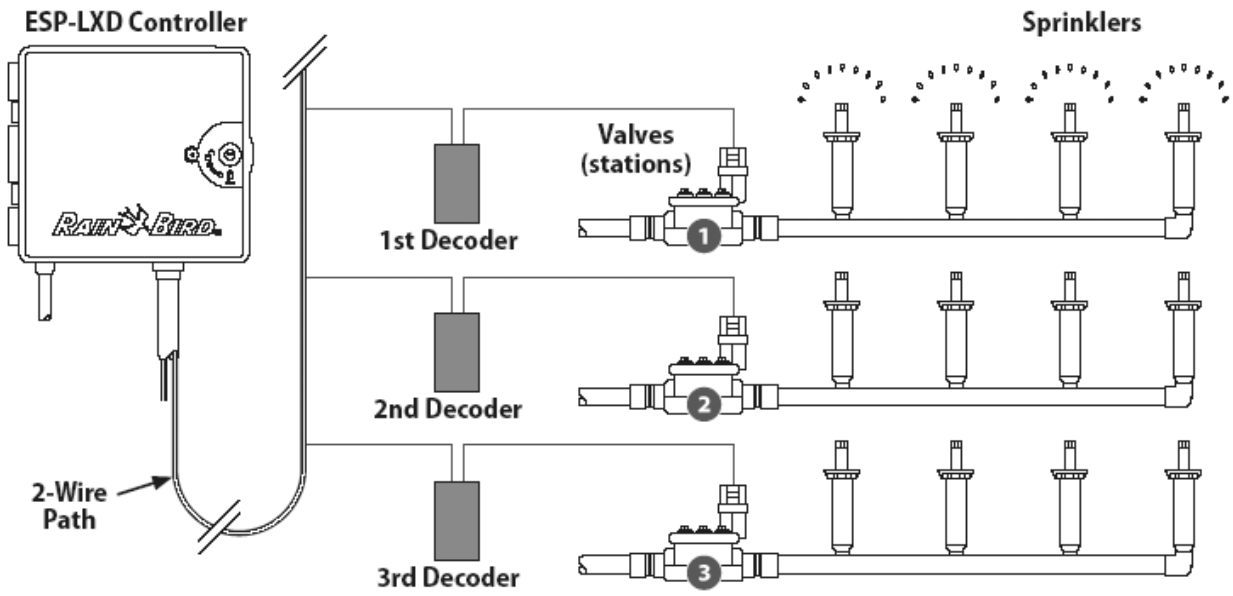

Typical Decoder and Valve Operation

## Advantages of a Decoder System

---

### **Aesthetics**

A Rain Bird ESP-LXD Decoder Controller provides transparent automatic control of the irrigation system. There are fewer above ground obstructions, making a decoder system ideal for an application in which the environmental elegance of the site is to remain undisturbed. Automatic irrigation control can be installed on a site with fewer above ground enclosures. Additionally, the high number of stations capable with a Rain Bird Decoder Controller minimizes the requirement of installing four or five traditionally wired controllers, where one Rain Bird Decoder Controller could be installed.

### **Designed for Protection from the Elements**

The field components of a Rain Bird Decoder System are designed for underground burial, so they are all completely weatherproof. This makes a decoder system a perfect application for a site that can be affected by flooding. Anywhere that an automatic control system can be damaged by the elements of nature a decoder system can be buried without fear of damage.

### **Vandal Resistant**

Since all the decoders are underground, a decoder system is the solution to the problem of vandal damage on an irrigation system. On a site where vandalism is a concern, a decoder system allows all of the field components to be put underground and out of sight in potentially lockable valve boxes, therefore, out of the reach of vandals.

### **Flexible Installation and Simple Expansion**

A Rain Bird ESP-LXD Decoder Controller System controls the field decoders with only a two-wire path running between all the decoders and the ESP-LXD Decoder Controller. This two-wire path carries all the communication for the decoders as well as powering the solenoids of the control valves. Decoders can be added to the field in any type of layout desired. This flexible installation simplifies the installation process, and also allows the installation to be done in multiple phases. The decoder system can be installed in phases initially. When additional areas are being prepared for irrigation, they can be connected to the rest of the system simply by splicing into the two-wire path on the existing layout. If a valve needs to be added or if sprinklers need to be added, simply wire the new valve to a decoder and connect the new decoder to the existing two-wire path and program the address for this decoder into the controller. This allows for installation of a Rain Bird Decoder System in multiple steps and also for simple expansion of the decoder system in the future.

## Layout

---

The design of a Rain Bird ESP-LXD Decoder Controller system requires careful consideration to the layout of the decoders on the 2-Wire path. Since a decoder system powers the electric solenoids through the 2-Wire path, the 2-Wire path must be able to provide enough voltage to power the solenoids. There are design specifications limiting the length of the two-wire Critical Path, the number of decoder addresses on a given two-wire path, and the number of simultaneous, active solenoids on a given two-wire path. Refer to page eight of this guide for design specifications.

### Two-Wire Path Layout

There are two types of configurations that can be used for the layout of the 2-Wire paths. The 2-Wire path can be installed as a STAR configuration, or as a LOOP configuration. The ESP-LXD Decoder Controller will supply up to four separate two-wire paths, of the STAR configuration and up to two separate 2-Wire paths, of the LOOP configuration for decoders. Depending upon the design of the site, it is typically preferable to separate the 2-Wire paths into multiple wire runs rather than install a single two-wire path throughout the site. These wire paths can be configured in either the STAR or LOOP layouts or a combination of the two types. For ease of troubleshooting, the STAR configuration is the recommended layout for the 2-Wire path.

### Notes:

---

## Star Configuration

For normal installations with wire runs that are not excessively long, the recommended layout for the 2-Wire path is the STAR configuration. This is to facilitate ease of troubleshooting the system should it experience a wire fault or short. The distance of the farthest decoder from the ESP-LXD Decoder Controller, measured along the two-wire path, is considered the Critical Path of the two-wire run for a STAR configuration. The maximum distance for the Critical Path is 1.65 miles for 14 AWG cable, and 2.63 miles for 12 AWG cable. For metric cable the maximum distance for the Critical Path is 3.0 Kilometers for 2.5 mm<sup>2</sup> cable.

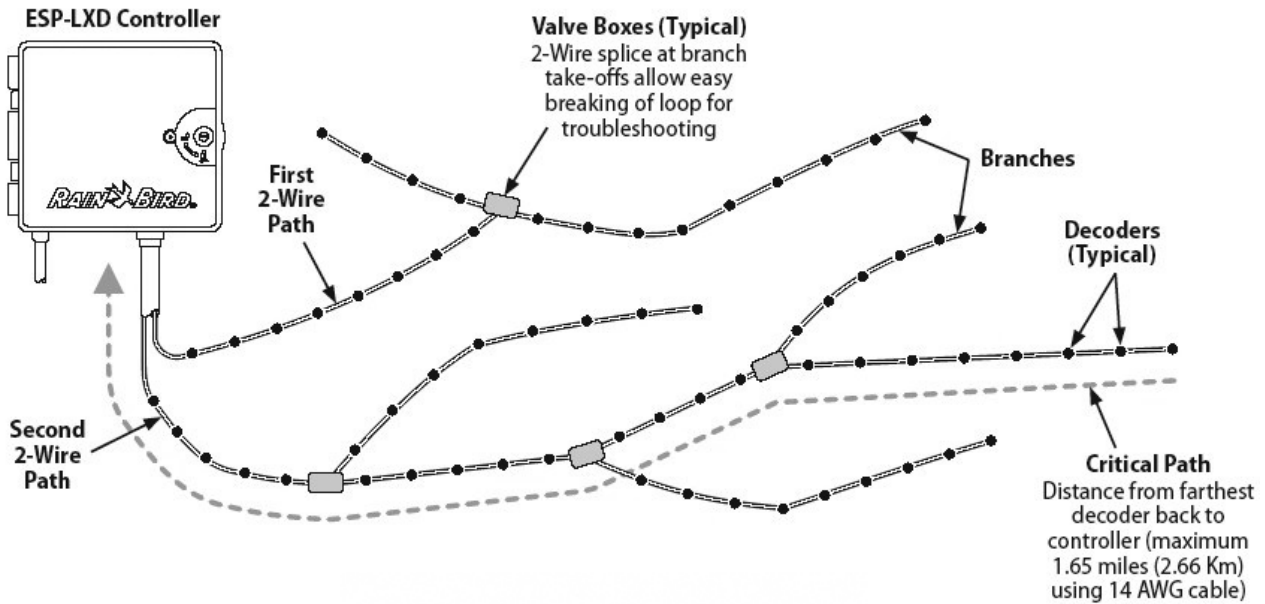

**2-Wire Path Star Pattern Design**

## Notes:

.....

## Loop Configuration

If the installation requires longer wire runs, than are possible with the STAR configuration, then a LOOP configuration may be used. A LOOP configuration requires looping back the 2-Wire path from the farthest decoder back to the ESP-LXD Decoder Controller. The main 2-Wire path can be looped, and any branch paths from the main 2-Wire path can also be looped, from the main path back to the main path. In a LOOP configuration, the Critical Path is the distance measured by following the 2-Wire path around the loop out to the farthest decoder and back to the ESP-LXD Decoder Controller. The maximum distance for the Critical Path, for a LOOP configuration is 6.61 miles for 14 AWG cable, and 10.52 miles for 12 AWG cable. For metric cable the maximum distance for the Critical Path is 12.0 Kilometers for 2.5 mm<sup>2</sup> cable. A diagram of the LOOP configuration layout is presented below.

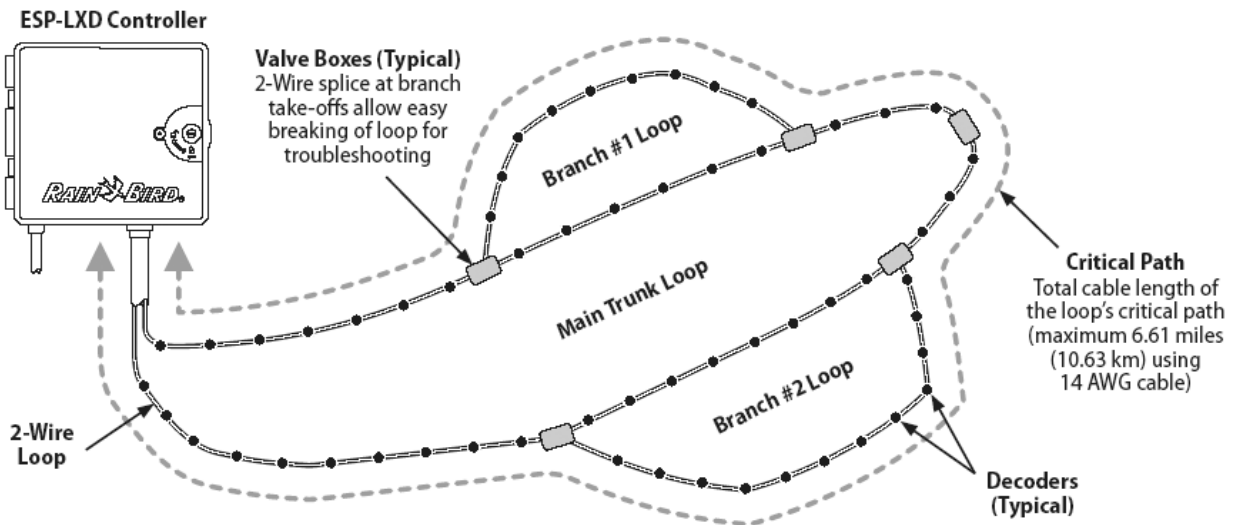

**2-Wire Path Loop Pattern Design**

Maximum Critical Path Lengths for 2-Wire Paths					
Nominal Wire Size	Ohms per 1000' or Ohms per Km (per conductor) Miles	Max. Length For Critical Path			
		Star		Loop	
		Km	Miles	Km	Miles
2.5 mm <sup>2</sup>	7.5 Ohms/Km	3.00	1.86	12.00	7.46
14 AWG	2.58 Ohms/1000'	2.66	1.65	10.63	6.61
12 AWG	1.62 Ohms/1000'	4.23	2.63	16.93	10.52

## Decoder to Solenoid Layout

All valves must be connected to field decoders for irrigation management by the controller. Decoders must be wired both to a valve and by splicing to the 2-Wire path. Splices and field decoders should always be placed in valve boxes (except when valve-in-head sprinklers are used, which can be directly buried).

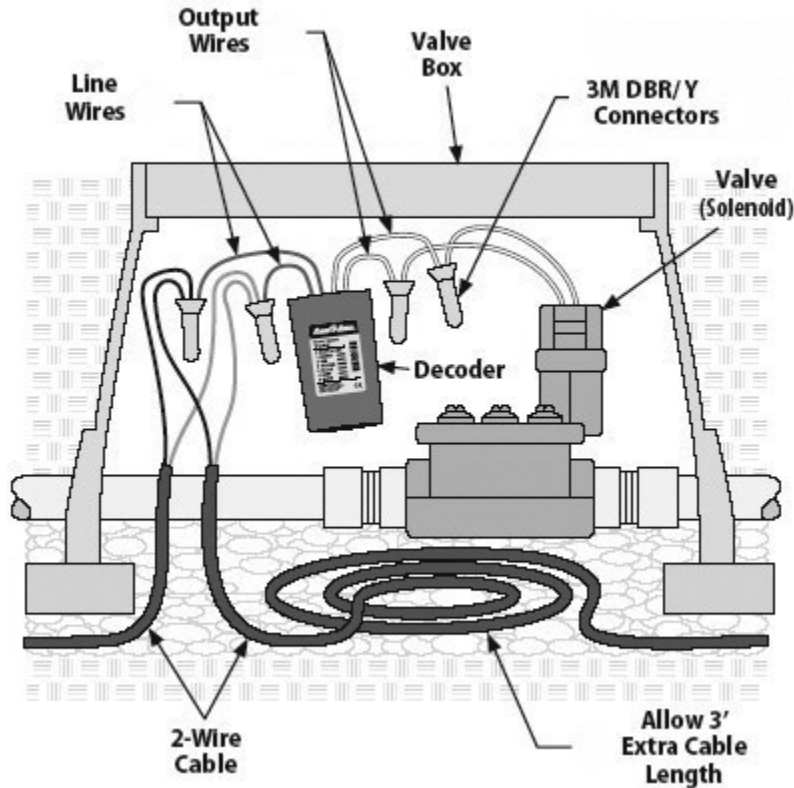

**NOTE:** For secondary wire run, the distance between the field decoder and the solenoid (valve) can not exceed 450 feet (137 meters) using 14 gauge wire.

## Valve Types

The ESP-LXD Decoder Controller will work with the following Rain Bird valves:

- PGA
- BPEB
- PEB
- BPES
- PESB
- VIH Rotors
- GB
- Pump Start Relay
- EFBCP

**NOTE:** The ESP-LXD Decoder Controller will not work with the Rain Bird DV Valve.



# ESP-LXD Decoder Controller Specifications

---

## ESP-LXD Decoder Controller

- The ESP-LXD offers the ability to expand from 50 stations to up to 200 stations in 75 station module increments.

## ESPLXD-M50 Decoder Module

Included with every ESP-LXD is the ESPLXD-M50 Decoder Module, a “double-wide” module which snaps onto two adjacent mounts on the controller backplane. The ESPLXD-M50 module includes the lugs for attachment of the two-wire path cables.

- Incorporates Flow Smart Module™ which features Learn Flow utility and flow usage totalizer.

## ESPLXD-SM75 Expansion Module

Adds an additional 75 stations in the ESP-LXD and snaps onto the controller backplane near the 50 station module. Up to two additional modules can be added to the controller.

## Built-in Flow Management

- FloManager™ - Ensures you don't overtax your water supply.
- FloWatch™ quickly identifies and isolates high or low flow situations, such as mainline breaks.
- Manages up to five (5) Points of Connection each through separate or combined Master Valves and FloZones – See Appendix for various configurations.

## FS-Series Flow Sensors

- Manages the input of five (5) flow sensors installed on the 2-Wire path – Sensor Decoder required for each sensor.

## SimulStations™

- The SimulStations™ feature allows the ESP-LXD to operate multiple stations at the same time to decrease the time required to irrigate the site – See Appendix for detailed information.

## Notes:

---

## Weather Sensor(s)

- Manages the input of 3 weather sensors installed on the 2-Wire path – SD-211 Sensor Decoder required for each sensor.
- Manages the input of 1 weather sensor installed at the Decoder Controller – no Sensor Decoder required.

### Notes:

1. **Operates only with Normally Closed Weather Sensors.**
2. **Does not have the capability to measure rainfall with a Tipping Rain Sensor.**
3. **Operates with Wind Speed Sensor that is installed with a Rain Bird PT – 3002 Pulse Transmitter.**

## PBC-LXD Programming Backup Cartridge

- **Backup and Restore.** The PBC allows eight full backups of all programming on up to eight ESP-LXD Decoder Controllers.
- **Decoder Address Entry.** Attach a barcode scanning pen (sold separately) and scan the peel-off barcode labels from the Programming Chart included with the controller. Your decoder addresses are entered for you automatically within minutes.

## ETC-LX ET Manager™ Cartridge

The Rain Bird ET Manager Cartridge easily upgrades the ESP-LXD Controller to an ET/Weather-based irrigation smart controller. Available in most parts of North America only, and requires a signal provider for your geographic area.

## IQ Compatible

Through the incorporation of an IQ-NCC Network Communication Cartridge, the ESP-LXD Decoder Controller can be controlled from the Rain Bird IQ™ Central Control System.

## Notes:

.....

## Metal Cabinet & Pedestal

The ESP-LXD Decoder Controller has an optional LXMM Metal Wall-Mount Enclosure and LXMM-PED Metal Pedestal. The ESP-LXD Decoder Controller standard plastic case field installs into the LXMM and can be wall-mounted or attached to the LXMMPED for free-standing controller applications.

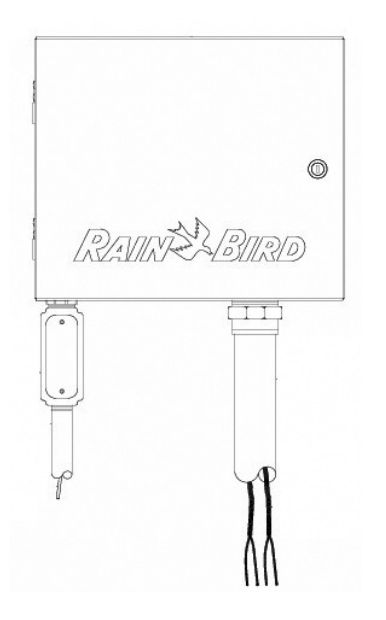

**ESP-LXD Two-Wire Decoder Controller in optional LXMM Metal Cabinet**

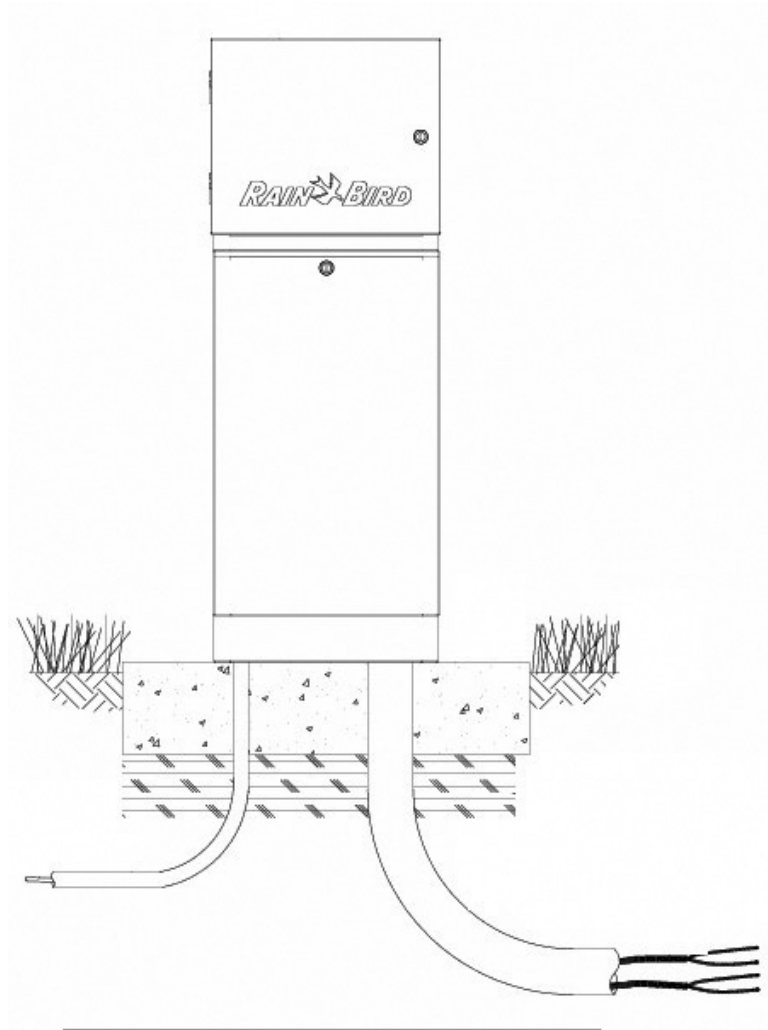

**ESP-LXD Two-Wire Decoder Controller in optional LXMM Metal Cabinet with LXMM-PED Metal Pedestal**

## Decoder Types & Specifications

---

### Field Decoders (Grey or Black)

Used to open and close valves for irrigation, these are the most commonly used decoders. Each model number is interpreted as the first number representing the number of addresses (or stations) and the last number representing how many solenoids can be activated per address. Each decoder is pre-programmed with a unique three, four or five digit address that is utilized to associate with a valve or station. These are the types of decoders used with the ESP-LXD Decoder Controller:

Rain Bird Field Decoder Models			
Decoder Model	Number of Addresses Per Decoder	Maximum Number Of Solenoids Per Address	Maximum Addresses Operating At Once
FD-101	1	1	1
FD-102	1	2	1
FD-202	2	2	2
FD-401	4	1	4
FD-601	6	1	4

**Note:** When activating valves and pump start relays that are not manufactured by Rain Bird, there may be exceptions to the maximum number solenoids per address that can be energized. Contact Rain Bird for more details.

### Notes:

---



# FD-101 One address – controlling one valve

---

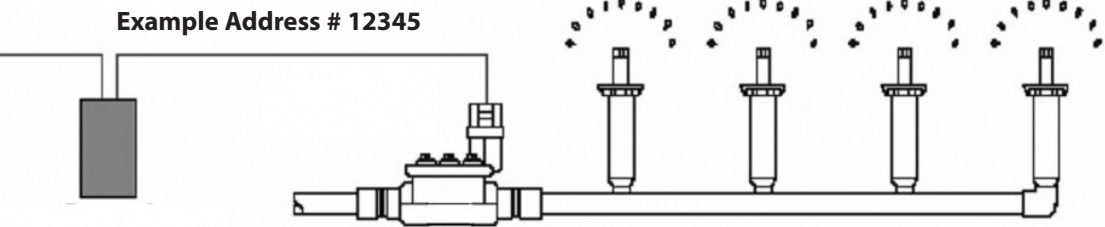

# FD-102 One address – controlling two valves simultaneously

---

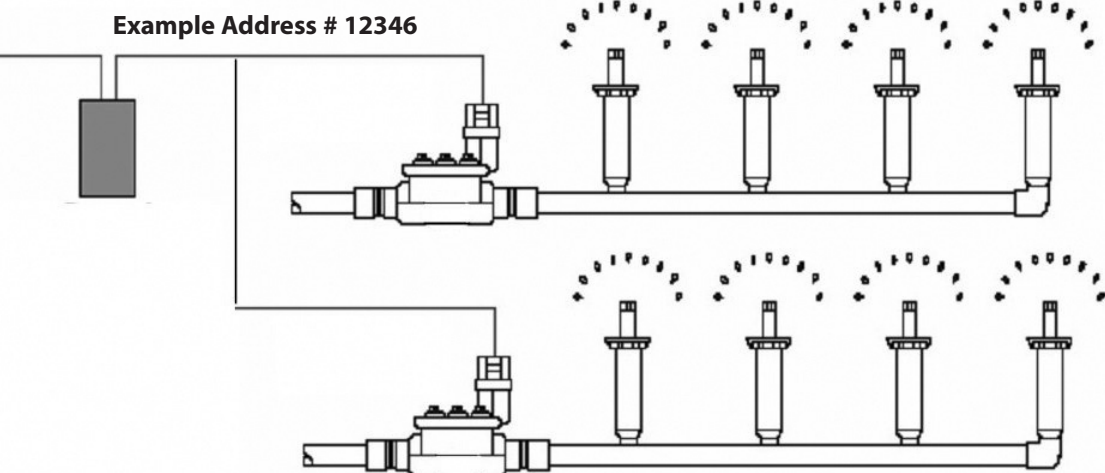

Notes:

---

# FD-202 Two addresses – each controlling two valves simultaneously

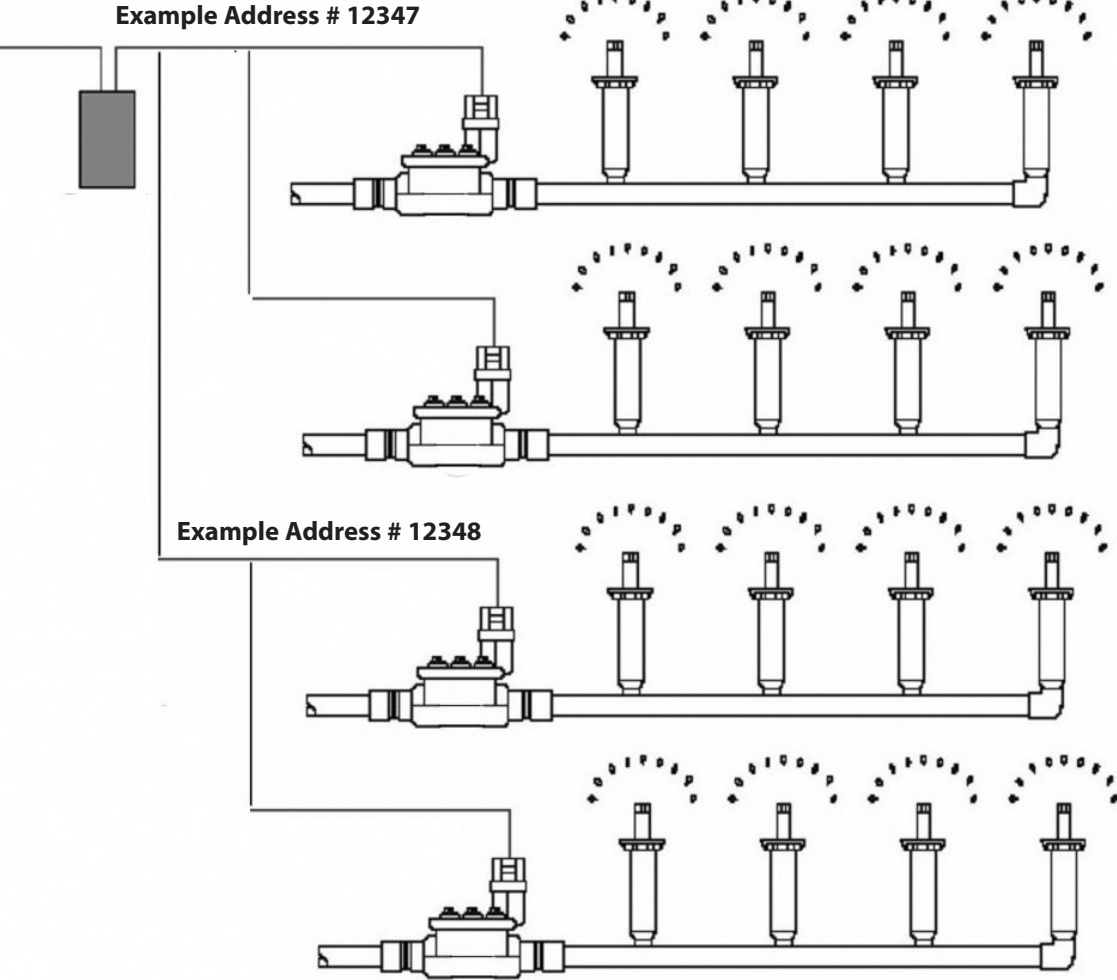

## Notes:

# FD-401 Four addresses – each controlling one valve

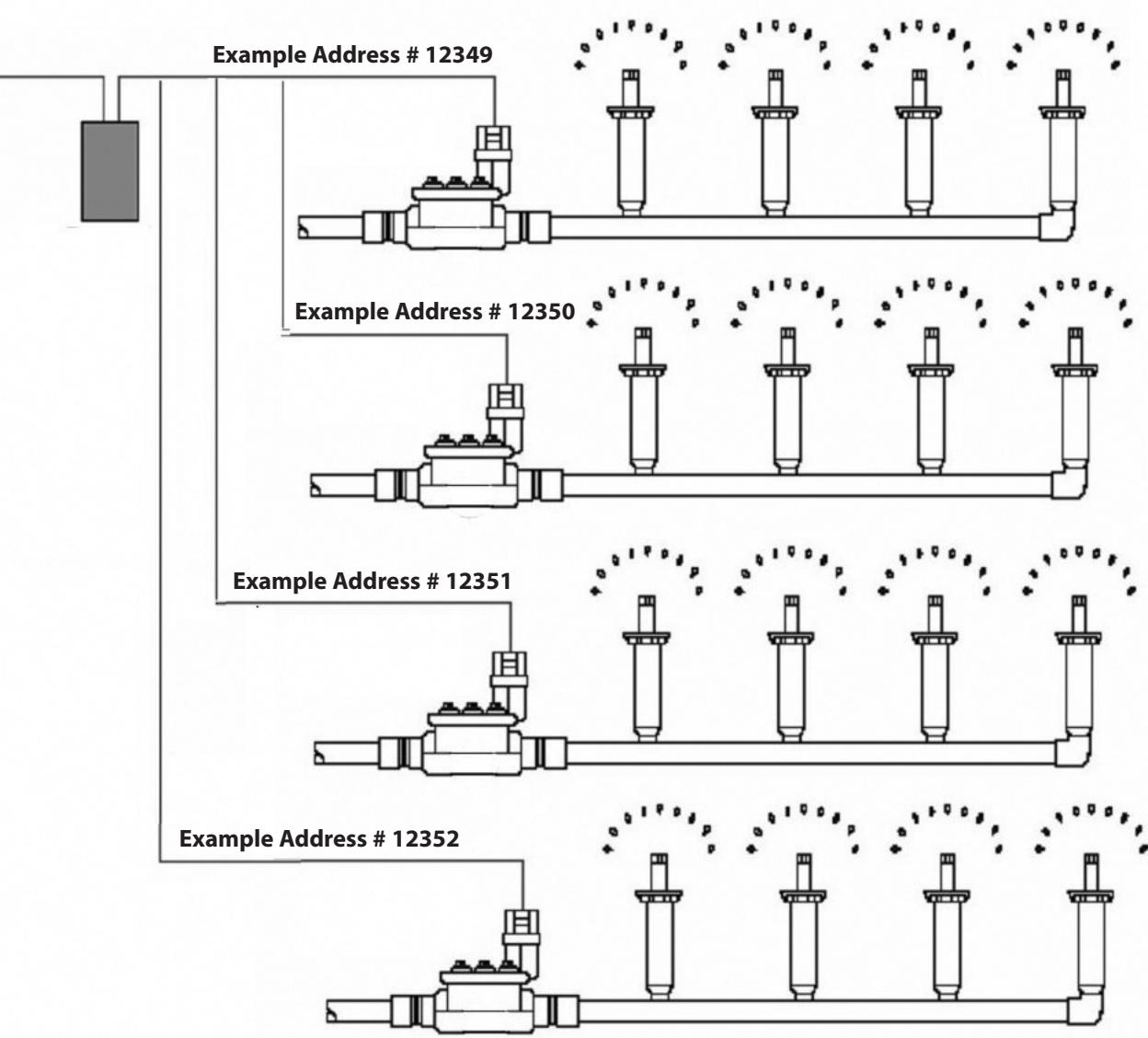

Notes:

# FD-601 – Six addresses – each controlling one valve

---

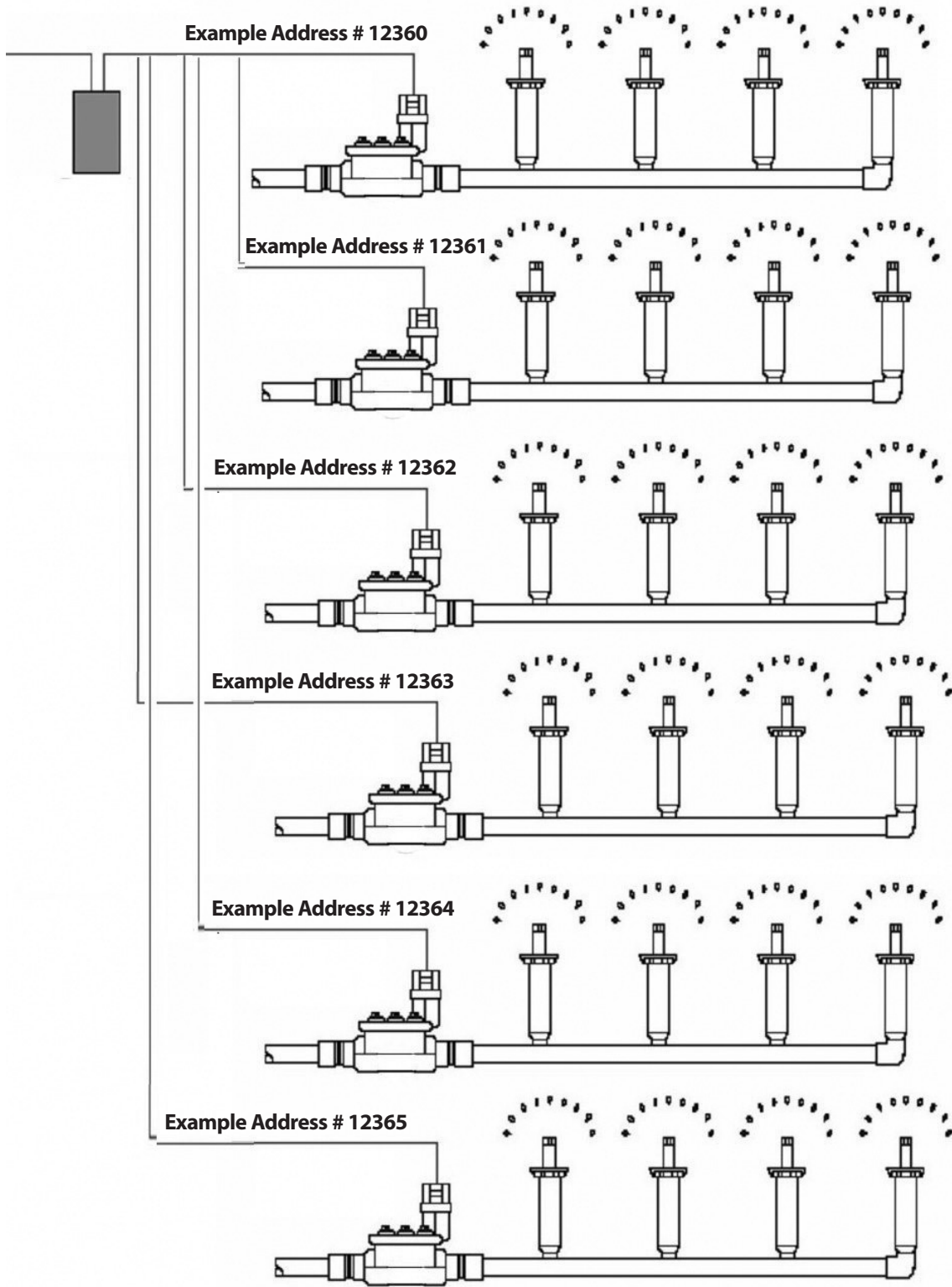



**Field Decoders – Grey vs. Black** The Rain Bird ESP-LXD Decoder Controller has the capability to operate 2-Wire Decoder based irrigation systems globally. It has been designed to automatically detect (based upon incoming voltage frequency) and configure itself to operate Grey or Black Field Decoders.

It is for this reason that only Grey Field Decoders are specified exclusively for US and Canadian installations and only Black Field Decoders are specified exclusively for all installations in the rest of the world.

**Examples:**

1. *The ESP-LXD Decoder Controller has been installed at a site in the US where the incoming power is 120 VAC @ 60 Hz. Upon being energized, the Decoder Controller will be configured to operate **Grey** Field Decoders.*
2. *The ESP-LXD Decoder Controller has been installed at a site in Europe where the incoming power is 230 VAC @ 50 Hz. Upon being energized, the Decoder Controller will be configured to operate **Black** Field Decoders.*

**Sensor Decoder – SD-211TURF**

The Rain Bird Decoder Controller integrates the use of select flow and weather sensors. The Sensor Decoder is pre-programmed with a unique five digit address that is utilized to associate with a flow or weather sensor.

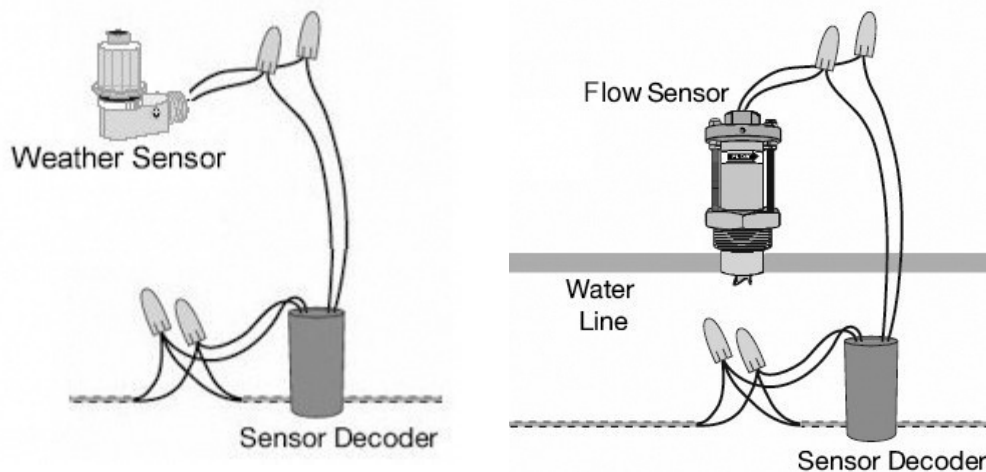

**Note: A Sensor Decoder must be used if the weather sensor is installed at any location along the 2-Wire path away from the ESP-LXD Decoder Controller.**

## Lightning Surge Protector – LSP-1 (Yellow)

The ESP-LXD controller and the 2-Wire path must be properly surge protected and grounded. Doing so can help prevent damage to the controller and irrigation system and also significantly reduce troubleshooting, repair time and expense. Failure to do so could result in failure of your controller and voiding the warranty.

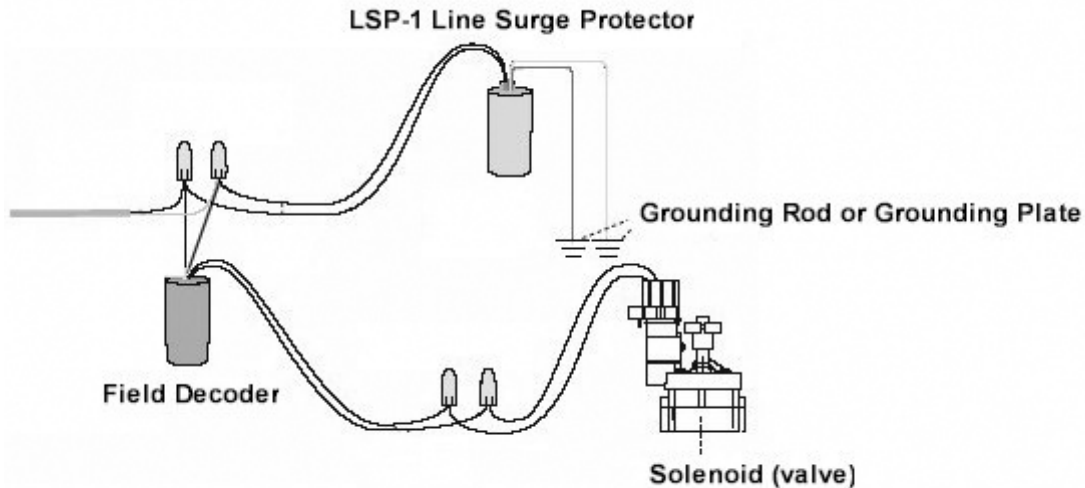

Refer to page 20 of this guide for recommended location and quantity of LSP-1 Lightning Surge Protectors.

## Wires & Splices

---

### MAXI Wire

Use only Maxi Wire for all 2-Wire path applications based upon the following factors:

1. Wire Size: 2.5mm<sup>2</sup>, 12 or 14 AWG
2. Dual conductor - solid core
3. Double isolation



Construction: Special irrigation control wire

Conductor: Tin coated, soft drawn bare copper (ASTM Spec. 33)  
Two (2) conductors Solid (14awg and 12 awg)

Insulation: Polyvinyl Chloride (PVC)

Outer Jacket: Polyethylene (PE)

Temperature: 60°C

Voltage: 600 volts

## Wire Splices

Use only 3M DBR/Y splice kits for all electrical wiring connections to the 2-Wire path. Improper wiring can cause serious damage to your controller or irrigation system.

## Grounding & Surge Protection Specifications

---

The ESP-LXD Decoder Controller and the 2-Wire path must be properly surge protected and grounded. Doing so can help prevent damage to the controller and irrigation system and also significantly reduce troubleshooting, repair time and expense. Failure to do so could result in failure of your controller and voiding the warranty.

To comply with proper installation specifications, the following components should be grounded:

- ESP-LX Decoder Controller
- ESPLXD-M50 Decoder Control Module
- LSP-1 Lightning Surge Protector
- FD-401 Field Decoder
- FD-601 Field Decoder

### Notes:

1. ***Each installed grounding system shall maintain a maximum ground resistance of 10 ohms, or less.***
2. ***Refer to the Rain Bird Grounding Recommendations document for proper specifications on Grounding System Installation and Grounding System Design.***

### ESP-LXD Decoder Controller

The ESP-LXD Decoder Controller is protected against electrical surges through the ground provided by the primary ground of the incoming power to the controller.

### ESPLXD-M50 Decoder Control Module

The ESPLXD-M50 Decoder Control Module provides a copper lug on the front of the module that accepts a #6 AWG Bare Copper Wire that is connected to a grounding grid.

### Notes:

---

## LSP-1 Lightning Surge Protector

The LSP-1 Lightning Surge Protector provides surge protection for the ESP-LXD controller and the 2-Wire path and should be spliced into the 2-Wire path in three distinct areas:

1. **ESP-LXD Decoder Controller** – The LSP-1 Lightning Surge Protector provides surge protection for the ESP-LXD Controller against electrical surges originating from each 2-Wire Path utilized. The LSP-1 Lightning Surge Protector shall be spliced into each 2-Wire Path immediately where the LSP-1 can be taken to ground to the ESP-LXD Decoder Controller.
2. **2-Wire Path** – The LSP-1 Lightning Surge Protector provides surge protection for the following Field Decoders installed on the 2-Wire Path:
  - FD-101
  - FD-102
  - FD-202
  - SD-211

**Note:** *The 2-Wire path shall be surge protected and grounded with one LSP every 500 feet or every 8 decoders, whichever is smaller.*

3. **Termination of 2-Wire Path** – An LSP-1 Lightning Surge Protector shall be installed at the end of the 2-Wire path in a STAR configuration.

## FD-401 and FD-601 Field Decoder

The FD-401 and FD-601 Field Decoders provides surge protection for the following Field Decoders installed on the 2-Wire Path:

- FD-101
- FD-102
- FD-202
- SD-211

**Note:** *Because the FD-401, FD-601 have surge protection already incorporated into the decoder, the 2-Wire path surge protection requirement could be stated in the following manner: The 2-Wire path shall be surge protected and grounded with one LSP-1, FD-401, or FD-601 every 500 feet or every 8 decoders, whichever is smaller.*



# Appendix

---

## Flow Management

The ESP-LXD Decoder Controller can manage up to five (5) Points of Connection, five (5) Master Valves and five (5) FloZones through a variety of hydraulic configurations using the following concepts and/or features:

- Master Valve – An automatic valve, which is installed at the point where the irrigation system connects to the water supply down stream of the backflow device (if applicable) and before the flow sensor.
- Flow Sensor – Used to monitor irrigation systems for proper flow rates within defined limits. They allow the system to read real-time water flow, which can be displayed to the operator, be used for control purposes, or to provide alerts and alarms.
- FloZone – A group of stations downstream of a master valve and flow sensor. In a shared main line, stations may be downstream of more than one master valve and flow sensor.

The following example designs represent the capabilities of the ESP-LXD to manage the flow of its irrigation system:

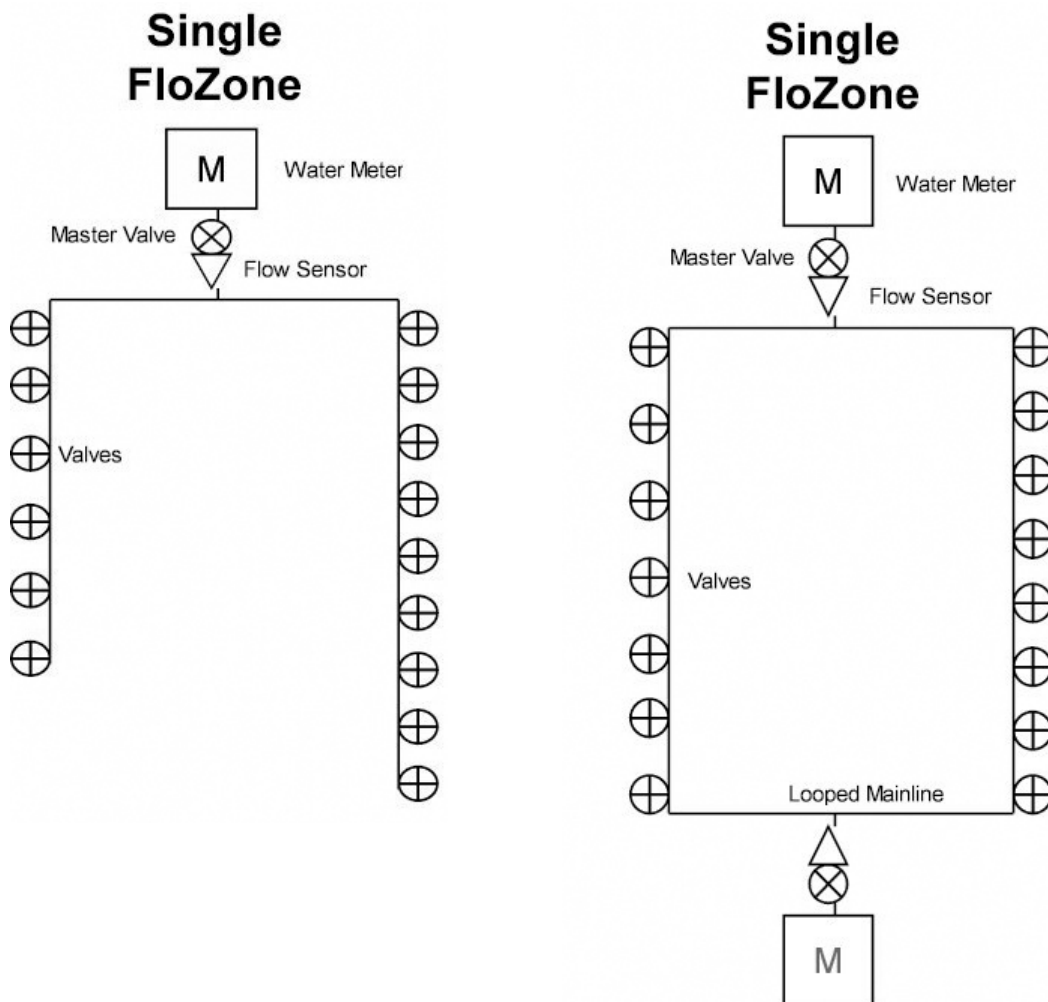

## Multiple FloZones

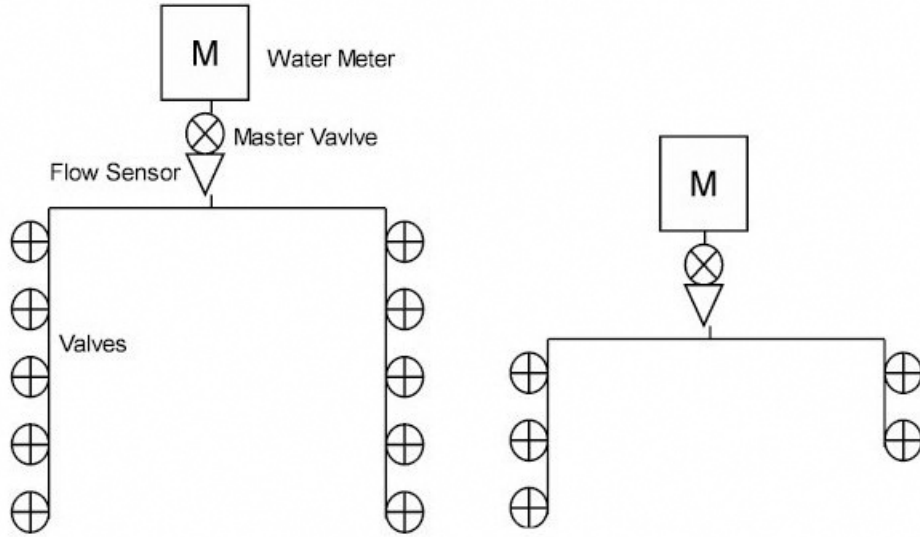

### Notes:

---

## Flow Sensor Sizing

- FS050P, FS075P, & FS100P flow sensors have an operating range 2 to 20 ft/sec (water velocity in pipe).
- FS150P, FS200P, FS300P, FS400P, & FS350 flow sensors have an operating range 1/2 to 30 ft/sec (water velocity in pipe).
- Select a pipe/meter size based on 50% of the lowest flow rate zone in the irrigation system.
- If the size required is too restrictive for the highest system flow rate (exceeds the upper flow limit of the sensor selected), a dual bypass meter system is recommended.

Model	Suggested Operating Range (Gallons / Minute)	Suggested Operating Range (Liters / Minute)	Suggested Operating Range (Cubic Meters / Hour)
FS050P	1.9 - 18.9	7.2 - 71.7	0.43 - 4.3
FS075P	3.3 - 33.2	12.6 - 125.8	0.75 - 7.5
FS100P	5.4 - 53.9	20.4 - 204	1.2 - 12.2
FS150P	5 - 100	18 - 378	1.1 - 22.7
FS200P	10 - 200	36 - 756	2.3 - 45.4
FS300P	20 - 300	78 - 1134	4.5 - 68.1
FS400P	40 - 500	150 - 1890	9.1 - 113.6
FS100B	2 - 40	6 - 150	0.5 - 9
FS150B	2 - 82.6	6.3 - 313	0.4 - 18.7
FS200B	4.9 - 294	18.5 - 1112	1.1 - 66.7
FS350B	12 - 45000*	48 - 168000*	2.7 - 10200*
FS350SS	12 - 45000*	48 - 168000*	2.7 - 10200*

\* Depends on pipe size and material

## Notes:

.....

## Flow Sensor Installation

- Sensor to be placed in straight run (sensor run) of pipe.
- A sensor run of no less than 10 times the pipe diameter\* on the sensor inlet is required.
- A sensor run of no less than 5 times the pipe diameter\* on the sensor outlet is required.
- The associated master valve would typically be installed on the upstream side before the sensor run.

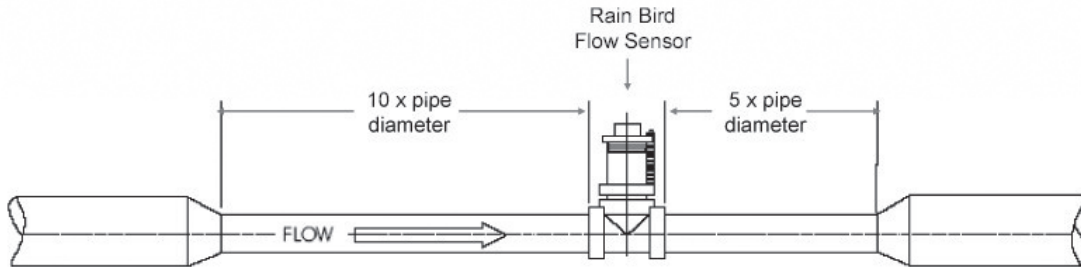

## Low Flow Bypass Design

A Low Flow Bypass design is where two (2) flow sensors are utilized to accurately measure both low & high flow rates on a single water source.

- The larger master valve's pressure regulator is set three (3) to five (5) lbs. lower than the pressure regulator on the smaller master valve.
- Low flows will automatically flow through the small master valve and flow sensor until the flow rate increases to the point where the three (3) to five (5) PSI differential is overcome and flow will automatically flow through both master valves and flow sensors.
- Program both master valves and both flow sensors on the same FloZone.

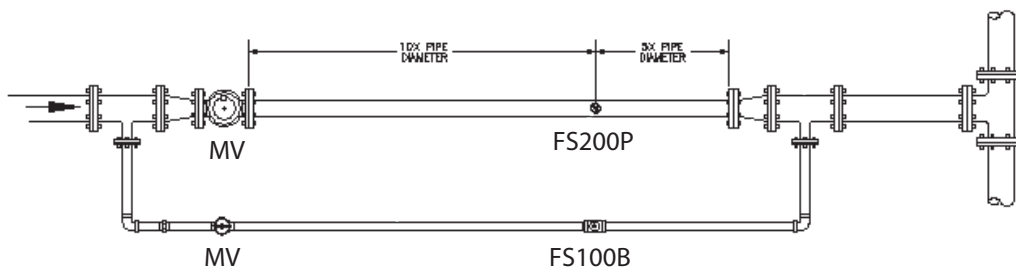

\* Standard or Metric sizes

## Pump Start Relay

Pump Stations less than 5 horsepower: Utilize FD102 Decoder connected directly to the pump start relay.

See installation detail below for connecting the ESP-LXD Decoder Controller to the Pump Start on the Pump Station Panel.

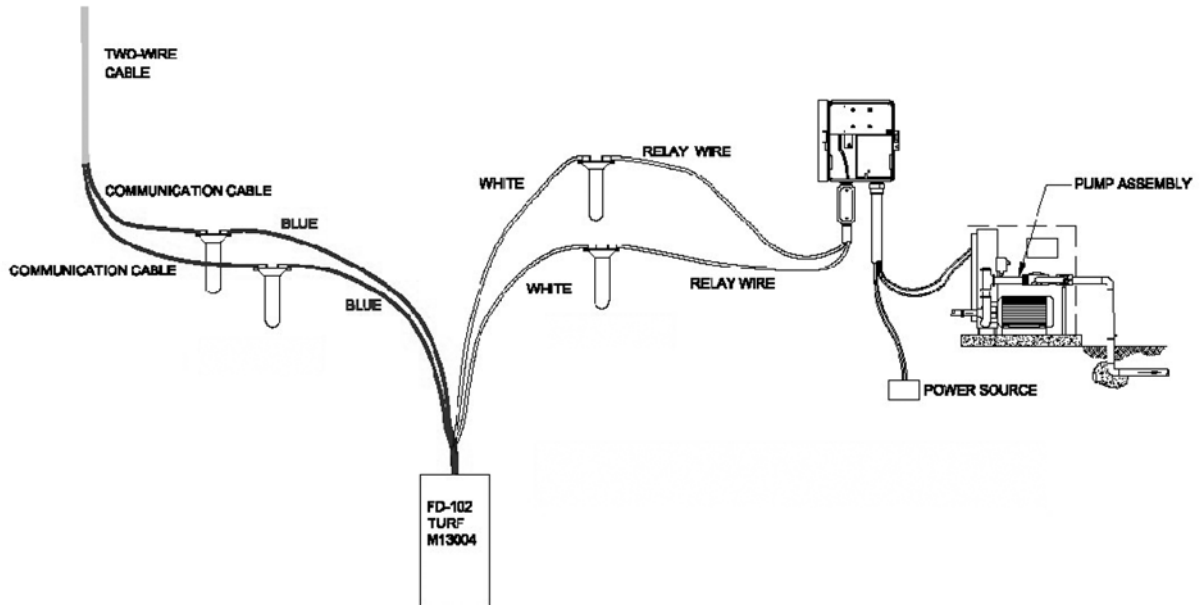

## SimulStations™

The ESP-LXD can operate multiple programs and stations concurrently. The controller ensures sufficient power is available to operate a maximum of eight (8) devices simultaneously.

- The range of SimulStations available per Program is one (1) through eight (8)
- The range of SimulStations available for the ESP-LXD is one (1) through (8) for irrigation and non-irrigation stations.

**Note: When SimulStations are set to the maximum of eight (8), and a Normally Closed Master Valve has to be held open for irrigation to occur, it will consume a SimulStation.**

# Rain Bird ESP-LXD Decoder Controller Specification Checklist

## I. Layout

Note: refer to page 7 of ESP-LXD 2-Wire Decoder System Design Guide for more wire size information

1. Star

Note: 4 AWG max. length 1.65 miles

Loop

Note: 4 AWG max. length 1.65 miles

## II. Wire

2. Maxi Wire – Quantity \_\_\_\_\_ ft/km

Note: Rain Bird recommends Paige Electric model # P7072D pictured to the right.



## III. Wire Splice

Note: For a proper wire connection manually twist the wires with lineman's pliers

3. 3M DBY/R – Quantity \_\_\_\_\_

(Two 3M DBR/Y Splices are required per decoder (FD-Series, SD-211, LSP-1) to connect to the 2-Wire Path. Two 3M DBY/R Splices are also required for each FD-Series Decoder connections to valve solenoids.)

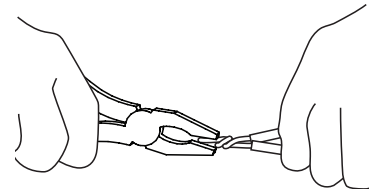

IV. Station Quantity  50\*  125  200

4. ESPLXD-SM75 Expansion Module  1  2

\* 50 Stations are provided with the ESP-LXD Decoder Controller

5. Master Valves  1  2  3  4  5

Notes: 1) Each Master Valve counts as a station.

2) Quantity of Master Valves and Flow Sensors should be the same.

3) Rain Bird residential valves (DV, HV, and JTV series) are not compatible with ESP-LXD decoders.

## V. Sensors

6. Flow Sensors \*\*  1  2  3  4  5

Types FS050 FS075 FS100 FS150 FS200 FS300 FS350 FS400

7. Weather Sensors  1  2  3 Remote\*\*  Local

Types  RSD  Rain Check  WR-2  WSS (with PT-3002)

8. \*\* SD-211 (TURF) Quantity \_\_\_\_\_

Note: SD-211 accepts input from flow sensors or remote weather sensors

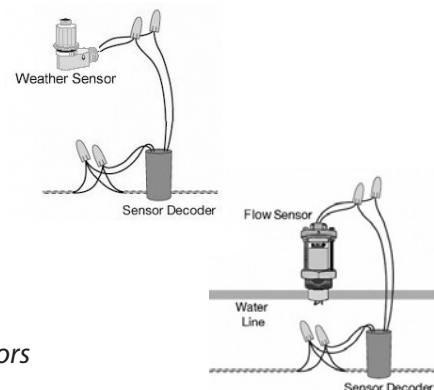



.....

---

**VI. Field Decoders**  **TURF** (to be used in U.S. and Canada)  **GOLF** (all other countries) *Use FD-102 when using a Pump Start Relay*

- 9. FD-101      Quantity \_\_\_\_\_
- 10. FD-102    Quantity \_\_\_\_\_
- 11. FD-102    Quantity \_\_\_\_\_
- 12. FD-401    Quantity \_\_\_\_\_
- 13. FD-601    Quantity \_\_\_\_\_

Rain Bird Field Decoder Models			
Decoder Model	Number of Addresses Per Decoder	Maximum Number Of Solenoids Per Address	Maximum Addresses Operating At Once
FD-101	1	1	1
FD-102	1	2	1
FD-202	2	2	2
FD-401	4	1	4
FD-601	6	1	4

---

**VII. Grounding & Surge Protection**

- 14. Grounding Rod      Quantity \_\_\_\_\_
- 15. Grounding Plate    Quantity \_\_\_\_\_
- 16. LSP-1 (Yellow)    Quantity \_\_\_\_\_

*Notes: 1) One LSP-1 per Wire Path from Controller / Every 500 Feet on Wire Path / Termination of each Wire Path.*

*2) Each installed grounding system shall maintain a maximum ground resistance of 10 Ohms, or less.*

---

**VIII. Programming Backup Cartridge (PBCLXD)**

---

**IX. ETC-LX ET Manager™ Cartridge w/ Antenna**

---

**X. NCC Cartridges**

---

**XI. LXMM Metal Wall-Mount Enclosure**

---

**XII. LXMM-PED Metal Pedestal**

---

**XIII. Registration - 6 months free Global Service Plan**

- 17. Register @ [http://rainbirdesplxd.prodsr.com/service\\_registration\\_form.php](http://rainbirdesplxd.prodsr.com/service_registration_form.php)  
GSP hotline 866-477-9778

---

**XIV. Troubleshooting**

- 18. Recommended troubleshooting tools: milliamp current clamp meter, multi-meter, and wire tracing and fault finding equipment.

## The Intelligent Use of Water.™

LEADERSHIP • EDUCATION • PARTNERSHIPS • PRODUCTS

---

At Rain Bird, we believe it is our responsibility to develop products and technologies that use water efficiently. Our commitment also extends to education, training and services for our industry and our communities.

The need to conserve water has never been greater. We want to do even more, and with your help, we can. Visit [www.rainbird.com](http://www.rainbird.com) for more information about The Intelligent Use of Water.™



---

**For questions regarding the products in this guide contact:**

**Rain Bird Corporation**  
6991 East Southpoint Road  
Tucson, AZ 85756  
Phone: (520) 741-6100  
Fax: (520) 741-6522

[www.rainbird.com](http://www.rainbird.com)

---

**For training on the products in this guide contact:**

**Rain Bird Services Corporation**  
6991 E. Southpoint Rd.  
Tucson, AZ 85756  
Toll Free: (800) 498-1942  
Fax: (520) 741-6168

[www.rainbirdservicescorporation.com](http://www.rainbirdservicescorporation.com)

**Specification Hotline**  
800-458-3005 (U.S. and Canada)