



Production & Service Center
2016 Board Exchange and Services Catalog



Table of Contents

Board Exchange Program

Board Exchange Tech Spec	2
Terms and Conditions	3
Commercial Circuit Boards	4
Golf Circuit Boards	10

Wireless Components

Golf & Commercial	17
-------------------------	----

Wireless Accessories

LINK900 Accessories & Antennas.....	19
Cellular Modem Antennas	21
WiFi Antennas	21
Antenna Cables	21
Antenna Mounting Clamps.....	21
LINK900 Multiplexer Accessories	22

Integrated Sensor System Accessories

ISS Antenna Kits	24
ISS Antenna Cables	24
ISS Antenna Coupler	24

Miscellaneous Parts & Cables

Short Haul Modems	26
FP-2PC Interface Cable	26
MAXI Cable Jacket Stripper	26
Clamp Meter	26
MIM 32-Volt Transformer	26
Station/Wire Marking Tags	26
Pedestal Key Sets	26
Null Modem Serial Cable	26
MIM Adapter	26

Miscellaneous Parts & Cables cont.

UHF Surge Suppressor	27
ESP WM Cabinet	27
CCU WM Cabinet	27
Commercial SS Pedestal	27
Serial Cable	27
MIM Cable	27
Antenna Cables	28
Antenna Cable Adapters & Attenuators	28

Central Control Services & Kits

Board Repair	30
Freedom Repeater Repair	30
Computer Repair	30
Computer Tune-Up Service	30
Next Business Day Programmed Decoder Replacement Service	30
ESP Pedestal Service Kit	31
ESP Cabinet Service Kit	31
Central Control Services	31

Rentals & Rental Kits

Site Survey Kits	33
Rotor Distribution Uniformity Kit	33
30 Day Loaners	34

Central Control Computer Replacement Parts

Replacement Computer	36
Computer Motherboard	36
Computer Power Supply	36
Edgeport	36
Modem	36

BOARD EXCHANGE



The Rain Bird® Board Exchange Program meets the needs of irrigation professionals with fast, dependable service for electronic circuit boards. As part of Rain Bird's commitment to quality, all boards are individually inspected, factory recertified, and backed with a one year warranty.

Board Exchange Program

The Rain Bird Board Exchange program is designed to meet your needs for a fast and reliable supply of electronic circuit boards when a “downtime” situation demands action. The program provides quick, easy, and dependable replacement of a damaged circuit board with genuine new or Rain Bird factory reconditioned boards. A simple phone call to your local Rain Bird Distributor will have the replacement board on site, or to your Distributor, the next business day to ensure your irrigation system is operating properly, as soon as possible.



Program Features:

- **Fast overnight delivery included.**
- **1 year warranty on all replacement boards.**
- **Rain Bird Factory recertified using OEM quality service and components.**
- **Latest firmware and engineering improvements for reliability and backwards compatibility.**
- **Guaranteed stock on all current production boards/components.**
- **20% discount for GSP Members**

Fast Service/Easy Installation:

When speed is essential to prevent damage to your turf or to your reputation, you can depend on Rain Bird. We stock an extensive supply of replacement boards for Rain Bird Golf and Commercial products, and we ship overnight to nearly any area of the United States. The replacement board can be shipped directly to your site or to your local Rain Bird Distributor. Simply contact your local Rain Bird Distributor to place your order, and have your replacement boards quickly on the way. Your Rain Bird Distributor can also arrange a service call to install the parts, if you choose not to install the parts yourself.

Pricing:

Pricing is fixed so you know the cost of the parts in advance. Pricing includes overnight shipping, and a prepaid return shipping label to recover the damaged board or component. If you are a current Global Service Plan Member, you will receive an additional 20% discount on all of your Board Exchange Program orders.

Quality:

Turning to the original manufacturer ensures you are using the highest quality replacement boards available. Use of OEM boards ensures full backwards compatibility and the reliability you have grown to know and trust with Rain Bird. All boards are new or factory reconditioned using only quality OEM Rain Bird components, which include all engineering improvements and the latest firmware. All Rain Bird circuit boards are backed by a 2 year warranty to provide you peace of mind.

Support:

We are product experts for your Rain Bird System and will make every effort to meet your needs, and provide you with the support necessary to keep your site's irrigation system operating like new. With the finest Distributor network in the irrigation industry, the combined support

of Rain Bird's Production & Service Center team, and the Global Service Plan Technical Engineering team, we are prepared to provide you with the best service available.

Service:

We offer a wide range of other services to fulfill your Golf and Commercial needs:

- **Board repair and refurbishment for all Rain Bird Circuit boards, including those no longer available.**
- **Sourcing of obsolete, discontinued, or hard to find circuit boards and components.**
- **Central Control computer repair and parts**
- **Site Survey Rental Kits**
- **Firmware chips and upgrades**
- **Repair and refurbishment (exchange) of all LINK radios**
- **900 MHz equipment, components, peripherals, and repair.**

Contact us today at:

Rain Bird Corporation
Production and Service Center
6991 E. Southpoint Rd
Tucson, AZ 85756
Toll Free: (866) 477-9778
Fax: (866) 429-5708

Email: GSPLabRequests@rainbird.com

Board Exchange Program

Board Exchange Program Terms and Conditions:

- All boards/components must be ordered and purchased through your local Rain Bird Golf or Commercial Distributor.
- Each Board Exchange order includes overnight shipping, whenever possible, within the US and Canada. Saturday delivery may be available for an extra charge. Return shipping labels are included.
- Damaged boards/components must be back in transit to the Production & Service Center within 48 hours or additional charges will apply.
- All board/components include firmware, displays, and cabling where applicable. All returned boards/components must be complete, with no components, circuitry, or covers/casing missing. A charge of \$75.00 will be incurred for returning incomplete assemblies. Full list price will be charged for items that are not returned altogether.
- Orders should be received at Rain Bird's Production and Service Center from the Rain Bird Distributor no later than 2:30PM (Mountain Standard Time) to ensure same-day shipment.
- Prices are subject to change without notice. Taxes are not included.
- The Rain Bird Production and Service Center will repair or replace, at no charge, any Board Exchange item/component that fails in normal use within the 1 year warranty period. This commitment to repair or replace is our sole and total warranty. The Rain Bird Production and Service Center will not, under any circumstances, be liable for incidental or consequential damages, no matter how they occur.
- The Board Exchange warranty does not warranty against damage to equipment or exchange boards/components caused by acts of God (lightning, electrical surges, flooding, fire damage, etc.).
- The 1 year warranty period begins upon the shipment of the board/component, as referenced on the warranty date label on each board/component.
- No failed exchange board/component will be considered for warranty replacement if it has been altered or repaired, or if any labels have been removed, altered, or defaced.
- No credit will be issued for any unused or incorrectly ordered exchange board/component.

*Free Exchanges for GSP Members

Standard Golf GSP Members and Classic and Plus Commercial GSP Members qualify for free exchanges. Only the items marked with an "*" in the Board Exchange Program section are eligible. Phone Only GSP Members do not qualify for this exchange program.

Visit <http://www.rainbird.com/gsp> to learn more about the benefits of our Global Service Plans.

Board Exchange Program

Free Exchanges for GSP Members*

Commercial Circuit Boards

Assembly Number	Controller / Interface	Name	Description /Picture
635110-01	ESP-MC/SAT	8 Station Output Board	
635110-02	ESP-MC /SAT	12 Station Output Board	
635110-03	ESP-MC/SAT	16 Station Output Board	
635110-13	ESP-MC/SAT	28 Station Output Board	
635110-05	ESP-MC/SAT	32 Station Output Board	
635110-14	ESP-MC/SAT	36 Station Output Board	
635110-06	ESP-MC/SAT	40 Station Output Board	
GSP700444	ESP-MC/SAT	8 Station Front Panel Assembly	
GSP700440	ESP-MC/SAT	12 Station Front Panel Assembly	
GSP700446	ESP-MC/SAT	16 Station Front Panel Assembly	
GSP700443	ESP-MC/SAT	28 Station Front Panel Assembly	
GSP700448	ESP-MC/SAT	32 Station Front Panel Assembly	
GSP700447	ESP-MC/SAT	36 Station Front Panel Assembly	
GSP700442	ESP-MC/SAT	40 Station Front Panel Assembly	

Surge-Enhanced output boards for ESP-MC and ESP Satellites and Site Sats



ESP-MC/SAT front panels







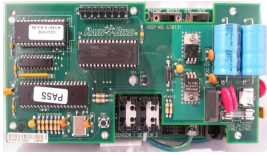
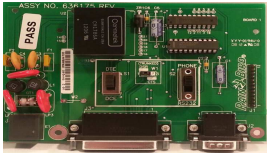
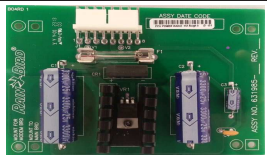

Board Exchange Program

Free Exchanges for GSP Members*

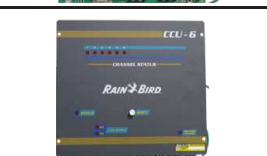
Commercial Circuit Boards

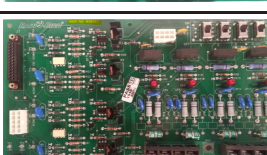

Assembly Number	Controller / Interface	Name	Description	Picture
633165-01	ESP	ESPXFRMR	ESP Transformer (LINK)	
*635622	ESP	ESP RC	Ribbon Cable	
633076-01	ESP	ESP LINK™ MIB	LINK Maxi Interface Board	
633079-01	ESP	ESP 2-WIRE MIB	2-Wire Maxi Interface Board	
635624-01	ESP	ESP SC	Sensor Cable	
635862	ESP	ESP IFC1	15-Inch Interface Cable	
633132	ESP	ESP IFC2	Interface Cable	
633148-01	ESP	ESP XFRMR	ESP Transformer - 2 Wire	
634356	ESP	ESP Modem Cable	ESP Modem Cable	

Board Exchange Program				Free Exchanges for GSP Members*
Commercial Circuit Boards				
Assembly Number	Controller / Interface	Name	Description	Picture
634405-03s (636131 & 633134)	ESP Site	Pre 2004 ESP Site Sat Replacement Kit	Site-Sat Upgrade Board Set	
*633561-01	CCU	CCU MODEM	Modem board for Cluster Control Units	
*631985-01	CCU	CCU PWB ASSY	PWB ASSY Power Supply	
*632496-01	CCU	CCU XFRMR	CCU Transformer	
*633145-01	CCU	CCU - 28 FP	CCU - 28 Face Plate Assembly	
*633145-02	CCU	CCU - 6 FP	CCU - 6 Face Plate Assembly	
*630461-02	TWI	2- GROUP OUTPUT	TWI 2 Group Output Board	
*630461-03	TWI	4 - GROUP OUTPUT	TWI 4 Group Output Board	
634433	All Controllers except COM	LINK MODEM	Modem Board for all LINK Controllers except COM	

Board Exchange Program

Free Exchanges for GSP Members*

Commercial Circuit Boards

Assembly Number	Controller / Interface	Name	Description	Picture
COM LINK RADIO	All LINK Controllers & Interfaces	NARROWBAND UHF RADIO	Narrowband LINK Radio (450-470 MHz)	
GOVT COM LINK RADIO	All LINK Controllers & Interfaces	GOVT NARROWBAND RADIO	Gov't Commercial Narrowband LINK Radio (400-420 MHz)	
COM RMK	All LINK Controllers & Interfaces	RADIO MODEM KIT	Commercial Narrowband Radio Modem Kit (450-470 MHz)	
GOVT COM RMK	All LINK Controllers & Interfaces	GOVT RADIO MODEM KIT	Gov't Commercial Narrowband Radio Modem Kit (400-420 MHz)	
GSPCAM	All LINK Controllers & Interfaces	CAM	Cluster Adapter Module (M50900)	
COM LINK MK	All LINK Controllers & Interfaces	MODEM KIT	Commercial LINK modem kit (no Radio)	



Board Exchange Program Free Exchanges for GSP Members*





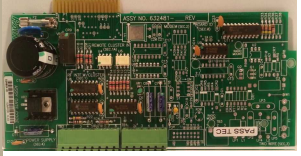
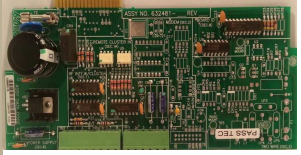
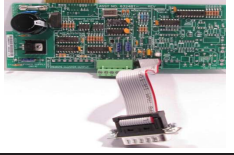
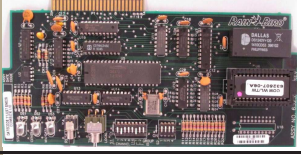
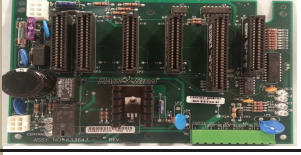
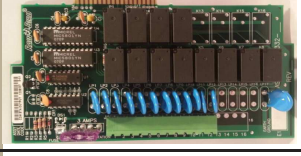
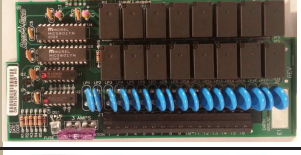
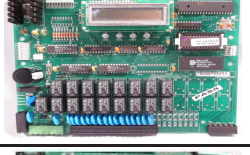

Commercial Circuit Boards

Assembly Number	Controller / Interface	Name	Description	Picture
GSPLXFP	ESP-LXME	SRESPLXMEFP	Service Replacement LXME Face Panel	
GSPLXDFP	ESP-LXD	SRLXDFP	Service Replacement LXD Face Panel	
GSPLXDMOD	ESP-LXD	SRM50	Service Replacement Two-Wire Decoder Module	
GSPLXDMOD2	ESP-LXD	SRS75	Service Replacement 75 Station Module	
GSPLX3G	ESP-LXME/ESP-LXD	SRIQNCC3G	Service Replacement NCC Cartridge - Cellular	
GSPLXWF	ESP-LXME/ESP-LXD	SRIQNCCWF	Service Replacement NCC Cartridge - Wi-Fi	
GSPLXEN	ESP-LXME/ESP-LXD	SRIQNCCEN	Service Replacement NCC Cartridge - Ethernet	
GSPLXRS	ESP-LXME/ESP-LXD	SRIQNCCRS	Service Replacement NCC Cartridge - RS-232	
GSPLXPH	ESP-LXME/ESP-LXD	SRIQNCCPH	Service Replacement NCC Cartridge - Phone	

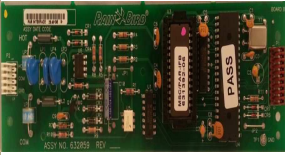
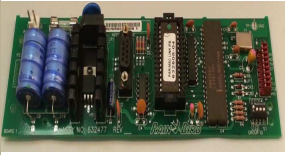
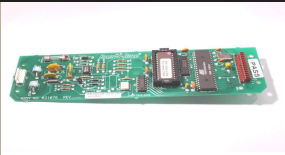
Board Exchange Program Free Exchanges for GSP Members*

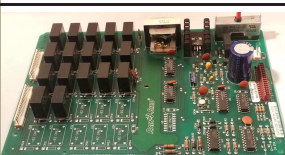
Golf Circuit Boards

Assembly Number	Controller / Interface	Name	Description	Picture
632481-01	COM Controller	2-WIRE IFB	COM 2-Wire Interface Board	
632481-02	COM Controller	CLUSTER	COM LINK™ Communication Cluster Board	
632481-04	COM Controller	LINK IFB	COM LINK Interface Board	
632329	COM Controller	CPU	COM CPU Board	
633643-01	COM Controller	MOTHERBOARD	COM Motherboard	
632332-01	COM Controller	12-STA. SOC	COM 12 Station Output Card	
632332-02	COM Controller	16-STA. SOC	COM 16 Station Output Card	
632056-01	PAR Controller	MLB-16 STA.	PAR 16 Station Main Logic Board	
632056-02	PAR Controller	MLB-24 STA.	PAR 24 Station Main Logic Board	









Board Exchange Program				Free Exchanges for GSP Members*
Golf Circuit Boards				
Assembly Number	Controller / Interface	Name	Description	Picture
632059	PAR Controller	2-WIRE IFB	PAR 2-Wire Interface Board	
632477	PAR Controller	LINK™ IFB	PAR LINK Interface Board	
631076	MSC Controller	2-WIRE IFB	MSC 2-Wire Interface Board	
631070	MSC Controller	MLB	MSC Main Logic Board	
631073-01	MSC Controller	16 STA. RELAY	MSC 16 Station Relay Board	
631073-02	MSC Controller	24 STA. RELAY	MSC 24 Station Relay Board	
632546	MSC Controller	LINK IFB	MSC LINK Interface Board	
633234-02	PAR+ Controller	MLB-OLD	PAR+ Main Logic Board - Old Style, for use with ROMs	
634955-02	PAR+ Controller	MLB-NEW	PAR+ Main Logic Board - New Style with no LED Cable, for use with OSMs	Replaced with 634955-04





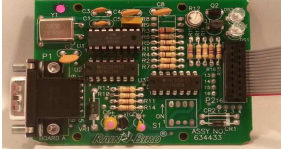

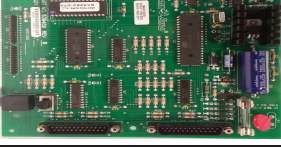

Board Exchange Program				Free Exchanges for GSP Members*
Golf Circuit Boards				
Assembly Number	Controller / Interface	Name	Description	Picture
634955-04	PAR+ Controller	MLB-NEW W/CABLE	PAR+ Main Logic Board - New Style with LED Cable, for use with OSMs	
633213	PAR+ Controller	OVERLAY	PAR+ Faceplate Overlay Membrane	
651569	PAR+ Controller	LATCH	Door Latch & Keeper (1st Generation Large Plastic Pedestal)	
633237-02	PAR+ Controller	PIB - OLD	PAR+ Power Interconnect Board - Old Style	Replaced with 635513-02
635513-02	PAR+ Controller	PIB - NEW	PAR+ Power Interconnect Board - New Style	
633214	MSC+ Controller	OVERLAY	MSC+ Faceplate Overlay Membrane	
633234-01	MSC+ Controller	MLB - OLD	MSC+ Main Logic Board - Old Style, for use with ROMs	
634955-01	MSC+ Controller	MLB - NEW	MSC + Main Logic Board - New Style with no LED Cable, for use with OSMs	Replaced with 634955-03
634955-03	MSC+ Controller	MLB - NEW W/CABLE	MSC + Main Logic Board - New Style with LED Cable, for use with OSMs	



Board Exchange Program Free Exchanges for GSP Members*

Golf Circuit Boards

Assembly Number	Controller / Interface	Name	Description	Picture
633304-01	MSC+ Controller	PIB - OLD	MSC+ Power Interconnect Board - Old Style	Replaced with 634474-01
634474-01	MSC+ Controller	PIB - NEW	MSC+ Power Interconnect Board - New Style	
633653	PAR+/ES/MSC+ Controller	ROM	Relay Output Module Board	
634677-01	PAR+/ES/MSC+ Controller	OSM	Output Station Module Board without Switches	
636709	PAR+/ES/MSC+ Controller	LOCK ASSEMBLY	Lock Assembly (Large Plastic Pedestal)	
634875	PAR+/ES/MSC+ Controller	RIBBON CABLE	Interface Board to Power Interconnect Board ribbon cable (10-pin F / 10-pin F)	
635118	PAR+ES/MSC+ Controller	LIGHT STRIP	Front Panel LED Light Strip	
635308	PAR+/ES/MSC+ Controller	BACKLIGHT	LED Backlight Assembly	
634677-02	PAR+/ES/MSC+ Controller	OSM-S	Output Station Module Board with Switches	

Board Exchange Program				Free Exchanges for GSP Members*
Golf Circuit Boards				
Assembly Number	Controller / Interface	Name	Description	Picture
633243	PAR+/ES/MS+ controller	2-WIRE IFB	2-Wire Interface Board	
633280	PAR+/ES/MS+ Controller	LINK™ IFB	LINK Interface Board	
635513-01	PAR+ES Controller	PIB	PAR+ES Power Interconnect Board	
634955-05	PAR+ES Controller	MLB	PAR+ES Main Logic Board - For use with OSMs with LED Cable	
635706	PAR+/ES/MS+ Controller	OVERLAY	PAR+ES Faceplate Overlay Membrane	
634433	All Controllers except COM	MODEM	Modem Board for all LINK Controllers except COM (Replaced with 634433)	
*630815	MIM™ Interface	DISPLAY	MIM Display Board - New Mechanical Switch Style (To replace old style with LCD Switches, order MIM Channel Switch Kit, part number 634817-02)	
*632671-2W	MIM/TWI Interface	CPU	MIM/TWI 2-Wire CPU Board	
*632671-LINK	MIM/TWI Interface	CPU	MIM/TWI LINK CPU Board	

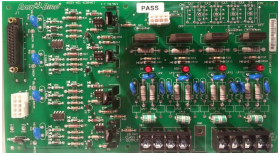
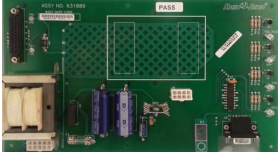
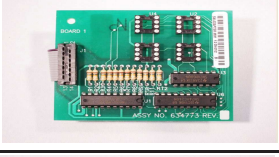
Board Exchange Program				Free Exchanges for GSP Members*
Golf Circuit Boards				
Assembly Number	Controller / Interface	Name	Description	Picture
*630461-02	TWI	OUTPUT BOARD	2-Wire Group Output Board	
*630461-03	TWI	OUTPUT BOARD	4-Wire Group Output Board	
GOLF LINK RADIO	LINK RADIO	NARROWBAND RADIO	Narrowband LINK Radio (450-470 MHz)	
GOVT LINK RADIO	LINK RADIO	GOVT NARROWBAND RADIO	Gov't Narrowband LINK radio (400-420 MHz)	
LINK RMK	LINK RADIO	RADIO MODEM KIT	Narrowband LINK Radio Modem Kit (450-470 MHz)	
GOVT LINK RMK	LINK RADIO	GOVT RADIO MODEM KIT	Gov't Narrowband LINK Radio Modem Kit (400-420 MHz)	
GSPCAM	LINK RADIO	CAM	Cluster Adapter Module (H60300)	
636104	PAR-ES DECODER	DIB	Decoder Interconnect Board	
*213045	ICI	ICI CPU	ICI CPU Board	

Board Exchange Program				Free Exchanges for GSP Members*
Golf Circuit Boards				
Assembly Number	Controller / Interface	Name	Description	Picture
*213046	ICI	ICI CPU	ICI Driver Board (2 WP, 1500 Stations)	
*630461	MIM/TWI Interface	2-WIRE OUTPUT	MIM/TWI 2-Wire Output Board	
*631889	MIM/TWI Interface	LINK OUTPUT	MIM/TWI LINK Output Board	
*634773	MIM	SWITCH ADAPTER	Switch Adapter Board for MIM Display Board	
631655-02	2 - Wire Pulse Decoder	PULSE DECODER	2 - Wire Pulse Decoder Board	
631655-03	2 - Wire Sensor Decoder	SENSOR DECODER	2 - Wire Sensor Decoder Board	

WIRELESS COMPONENTS



Don't waste time searching elsewhere for Rain Bird wireless components, GSP Services has all of your wireless component needs covered.

Wireless Componets			
Golf and Commercial Wireless Components			
Service Part Number	Component	Description	Item Image
GSP-GLF900RADIO	LINK900 RADIO	Replacement 900 MHz radio module for Golf LINK900	
GSP-GLF900IFB	LINK900 RADIO	Replacement 900 MHz interface board for Golf LINK900	
GSP-SC900RADIO	LINK900 RADIO	Replacement 900 MHz radio module for Site Control LINK900	
GSP-SC900IFB	LINK900 RADIO	Replacement 900 MHz interface board for Site Control LINK900	
GSP-MAXI900Radio	LINK900 RADIO	Replacement 900 MHz radio module for Maxicom LINK900	
GSP-MAXI900IFB	LINK900 RADIO	Replacement 900 MHz interface board for Maxicom LINK900	
VERIZMDM	CELLULAR MODEM	Cellular Data Modem - Verizon (formerly M88105)	
SPRINTMDM	CELLULAR MODEM	Cellular Data Modem - Sprint (formerly M88104)	
GPRSMDM	CELLULAR MODEM	Cellular Data Modem - GPRS (formerly M88106)	

WIRELESS ACCESORIES (LINK900, Cellular, WiFi)



Need accessories to install and maintain your Rain Bird wireless system? GSP Services has all your LINK900, Cellular, and WiFi accessory needs covered.

Wireless Accessories

900 MHz (LINK900) Accessories

Assembly Number	Controller / Interface	Description	Picture
GSP-CCUPLATE	LINK900	CCU Mounting Plate LINK900 radio; includes ribbon cable	
GSP-TW-LPNPBHJ	LINK900	N-Type (M/F) Antenna Surge Protector	
GSP-TNCMXNF	LINK900	TNC-M x N-F adapter	
GSP-TNCFXNM	LINK900	TNC-F x N-M adapter	
GSP-YCABLE	LINK900	DB9 Y-Cable Splitter (F x 2M)	
GSP-DSP-1	COMMERICAL CENTRAL CONTROL	Ethernet Surge protector	
GSP-MDS-PRGCBL	LINK900	Programming cable for MDS radios	
GSP-TRA9023N	LINK900	3" omni antenna - 3dBd, NMO mount with 3 ft cable TNC-M	



Wireless Accessories

900 MHz (LINK900) Antennas

Assembly Number	Controller / Interface	Description	Picture
GSP-TRA9023NP	LINK900	3" omni antenna - 3dBd, N mount with 3 ft cable TNC-M	
GSP-4P906NMO	LINK900	Low profile disk antenna - 0 gain, NMO mount with 3 ft cable TNC-M	
GSP-RD1	LINK900	3" Rubber duck - 1dBd SMA male	
GSP-YAGI-6	LINK900	6 dBd Yagi antenna N-Female	
GSP-YAGI-10	LINK900	10 dBd Yagi antenna N-Female	
GSP-ODA-96	LINK900	96" omni antenna - 7dBd N-Male	
GSP-ODA-48	LINK900	48" omni antenna - 5dBd N-Male	
GSP-ODA-23	LINK900	23" Omni antenna - 3dBd N Female	

Wireless Accessories



Cellular Modem Antennas

Assembly Number	Controller / Interface	Description	Picture
GSP-PSKN	CELLULAR MODEM	Rubber duck - 3dBi gain w/SMA male connector	
GSP-RM3	CELLULAR MODEM	3" omni antenna - 3dBi gain with 1 ft cable & SMA-Male connector	

WiFi Antennas

GSP-TRA24003NP	WIFI	WiFi Antenna: 3" omni antenna (N-F connector) with 3 ft cable with N-Male and SMA-M	
----------------	------	---	--

Antenna Cables

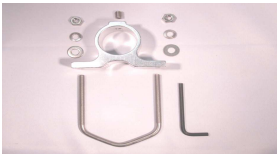

GSP-xx FT-LMR400	ALL WIRELES CONTROLLERS & INTERFACES	LMR400 cable with N or TNC connectors M & F. (Please specify custom length in Part Number, i.e., xx) Over 75 ft is not recommended	
GSP-xxFT-LMR195	ALL WIRELESS CONTROLLERS & INTERFACES	LMR195 cable with N or TNC connectors M & F. (Please specify customer length in Part Number, i.e. xx) Over 75 ft is not recommended	

Antenna Mounting Clamps

GSP-FM2	LINK900	Double clamp for 8' omni	
GSP-MMK9	LINK900	Single clamp for 4' & 23" omni	

Wireless Accessories

900 MHz (LINK900) Multiplexer Accessories

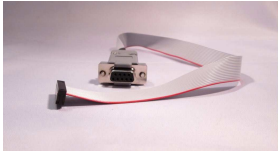



Assembly Number	Controller / Interface	Description	Picture
GSP-MPX-INV	LINK900	Inverter module to connect UHF radio to MPX	
GSP-MPX-PWR	LINK900	Power supply for MPX	
GSP-MPX-CBL	LINK900	Ribbon serial cable to connect LINK900 radio to MPX	

INTEGRATED SENSOR SYSTEM ACCESSORIES



GSP Services has the components you need to install the Intergrated Sensor System to Rain Bird's specifications. From adapters to OEM antenna kits, we have you covered.

Integrated Sensor Systems Accessories







Assembly Number	Controller/Interface	Name	Description	Assembly Number Location
GSP700510	Integrated Sensor System	ISS ANTENNA KIT	ISS Antenna Kit 1 - Omni directional antenna Polyphaser, 10 ft Gateway antenna cable assembly, 10 ft coax cable assembly	
GSP700520	Integrated Sensor System	ISS ANTENNA KIT	ISS Antenna Kit 2 - Omni directional antenna, Polyphaser, 10 ft Gateway antenna cable assembly, 20 ft coax cable assembly	
GSP700530	Integrated Sensor System	ISS ANTENNA KIT	ISS Antenna Kit 3 - Omni directional antenna, Polyphaser, 10 ft Gateway antenna cable assembly, 30 ft coax cable assembly	
GSP700540	Integrated Sensor System	ISS ANTENNA KIT	ISS Antenna Kit 4 - Omni directional antenna, Polyphaser, 10 ft Gateway antenna cable assembly, 40 ft coax cable assembly	
GSP700551	Integrated Sensor System	ANTENNA CABLE	10 ft. ISS Extension Cable - N-Male to N-Male 400 series coax cable assembly	
GSP700552	Integrated Sensor System	ANTENNA CABLE	20 ft. ISS Extension Cable - N-Male to N-Male 400 series coax cable assembly	
GSP700553	Integrated Sensor System	ANTENNA CABLE	30 ft. ISS Extension Cable - N-Male to N-Male 400 series coax cable assembly	
GSP700554	Integrated Sensor System	ANTENNA CABLE	40 ft. ISS Extension Cable - N-Male to N-Male 400 series coax cable assembly	
GSP700555	Integrated Sensor System	ANTENNA COUPLER	Coaxial coupler - N-Female/N-Female	

MISCELLANEOUS PARTS & CABLES



The GSP Services list of cables, adapters, and tools offers a fast solution for irrigation professionals who need to build troubleshooting tool kits or replace hard to find components of Rain Bird® central control systems.

Miscellaneous Parts & Cables			
Service Part Name	Service Part Number	Description	Item Image
Short Haul Modems	GSP700439	Short haul modems used for direct connection to weather stations or pump stations.	
FP-2PC Interface Cable	GSP700436	Connects The FREEDOM System repeater to the central control PC .	
MAXI® Cable Jacket Stripper	GSP700404	Safely and quickly removes the outer jacket from Maxi cable without damaging the inner insulation. Minimum order quantity of 5.	
Decoder System Digital Clamp Meter	GSP700405	Effectively read current on decoder system installations and troubleshoot issues without taking splices apart.	
MIM™ 32-Volt Output Transformer	GSP631060	Used to replace the 26.5 volt output transformer in a MIM when the MIM is used with older SBM controllers.	
Station/Wire Marking Tags	GSP700402	Sold in a quantity of 50 tags.	
Pedestal Key Sets	GSPCH751 GSPR200	Available for all golf and commercial type pedestals. GSPCH751 is for commercial and GSPR200 is for golf. Sold in pairs.	
Null Modem Serial Cable	GSP700435	6ft. - DB-9 (F) to DB-9 (F) null cable for use with MDI and MDC	
MIM Adapter	GSP651030	MIM bear claw adapter (DB-9 to RJ12)	

Miscellaneous Parts & Cables			
Service Part Name	Service Part Number	Description	Item Image
UHF Surge Suppressor	GSP700455	Surge suppressor for FREEDOM System Antenna (Polyphazer)	
ESP WM Cabinet	GSPESPCAB	Service replacement ESP MC/SAT/SITE wall mount cabinet with transformer	
CCU WM Cabinet	GSPCCUCAB	Service replacement CCU wall mount cabinet with transformer	
Commercial SS Pedestal	GSPSSPED	Service replacement stainless steel pedestal (componets also available)	
Serial Cable	GSP700433	6 ft. - DB-9 (F) to DB-9 (M) serial cable for use with LDI and SDI	
MIM Cable	GSP700438	MIM cable (25 ft.)	

Miscellaneous Parts & Cables

Service Part Name	Service Part Number	Description
Antenna Cables For Rain Bird Freedom Systems, LINK, and MLRK applications.	GSP700411	10 ft. - N (M) to N (M) - (WBC-400 Cable) 50 Ohm RF cable
	GSP700412	20 ft. - N (M) to N (M) - (WBC-400 Cable) 50 Ohm RF cable
	GSP700413	30 ft. - N (M) to N (M) - (WBC-400 Cable) 50 Ohm RF cable
	GSP700414	40 ft. - N (M) to N (M) - (WBC-400 Cable) 50 Ohm RF cable
	GSP700415	50 ft. - N (M) to N (M) - (WBC-400 Cable) 50 Ohm RF cable
	GSP700416	3 ft. - BNC (M) to N (M) - (RG-58 Cable) 50 Ohm RG cable
Antenna Cable Adapters & Attenuators	GSP700418	3 dB - BNC (M) to BNC (F) RF Attenuator to reduce signal strength
	GSP700419	6 dB - BNC (M) to BNC (F) RF Attenuator to reduce signal strength
	GSP700420	10 dB - BNC (M) to BNC (F) RF Attenuator to reduce signal strength
	GSP700421	20 db - BNC (M) to BNC (F) RF Attenuator to reduce signal strength
	GSP700422	30 db - BNC (M) to BNC (F) RF Attenuator to reduce signal strength
	GSP700424	N - Female / N-Female Adapter
	GSP700425	UHF - Female / UHF - Female Adapter
	GSP700426	N - Male / UHF - Female Adapter
	GSP700427	UHF - Male / N- Female Adapter
	GSP700428	N - Female / BNC - Male Adapter
GSP700429	BNC - Female / BNC - Female Adapter	

Additional items may be available upon request. Contact the GSP Services Production & Service Center at (866) GSP-XPRT for inquiries.

CENTRAL CONTROL SERVICES & KITS



From circuit board repair to replacement field decoders, programmed to match on-site specifications, our services and service kits provide industry professionals with new options for system maintenance and support.

Central Control Services

Service Part Name	Service Part Number	Description
Board Repair	GSPREPAIR	Expedited repair service on any Rain Bird Controller or field interface circuit board (excludes ICI)
Freedom Repeater Repair	GSP700319	Rain Bird Golf FREEDOM System repeater repair service (includes pick-up, repair, and return)
Computer Repair	GSP700337	Full service repair of Rain Bird central control computer hardware and operating software (including virus removal & file recovery)
Computer Tune -Up Service	GSP700301	GSP will arrange for the end user's computer to be shipped to Rain Bird's Production & Service Center where a certified service technician will perform a 21-point hardware check and a 13 point software inspection to ensure system functionality, health, and virus protection.

Next Business Day Programmed Decoder Replacement Service

Next Business Day Programmed Decoder Replacement Service: FD101GOLF	GSP700302
Next Business Day Programmed Decoder Replacement Service: FD102GOLF	GSP700303
Next Business Day Programmed Decoder Replacement Service: FD202GOLF	GSP700304
Next Business Day Programmed Decoder Replacement Service: FD401GOLF	GSP700305
Next Business Day Programmed Decoder Replacement Service: FD601GOLF	GSP700306
Next Business Day Programmed Decoder Replacement Service: SD210	GSP700307
Next Business Day Programmed Decoder Replacement Service: FD101TURF	GSP700331
Next Business Day Programmed Decoder Replacement Service: FD102TURF	GSP700332
Next Business Day Programmed Decoder Replacement Service: FD202TURF	GSP700333
Next Business Day Programmed Decoder Replacement Service: FD401TURF	GSP700334
Next Business Day Programmed Decoder Replacement Service: FD601TURF	GSP700335



Keep your current database addresses and "as-builts" matched up to decoder addresses in the field. Decoders are programmed to match replacement addresses at the time of order.



Service Kits

Service Part Name	Service Part Number	Description
ESP Pedestal Service Kit	GSP700417	Stainless Steel Pedestal Service Kit - allows for the installation of the current ESP-MC/SAT water resistant front panel in older Rain Bird stainless steel pedestals.
ESP Cabinet Service Kit	GSP700450	Wall Mount Cabinet Service Kit - allows for the installation of the current ESP-MC/SAT water resistant front panel in pre-2003 wall mounted cabinets.

Central Control Services

MIM™/TWI 2-Wire EPROM Chip (2-Wire/LINK) with carrier	GSP700445C	Replacement EPROM Chip for MIM/TWI CPU board (2-Wire or LINK) with chip carrier
MIM/TWI 2-Wire EPROM Chip (2-Wire/LINK) without carrier	GSP700445NC	Replacement EPROM chip for MIM/TWI CPU Board (2-Wire or LINK) without chip carrier
Custom Order EPROM Chips	GSP700449	Special programmed (firmware) EPROM chips for most Golf and Commercial central control field interfaces and satellites.

RENTALS & RENTAL KITS

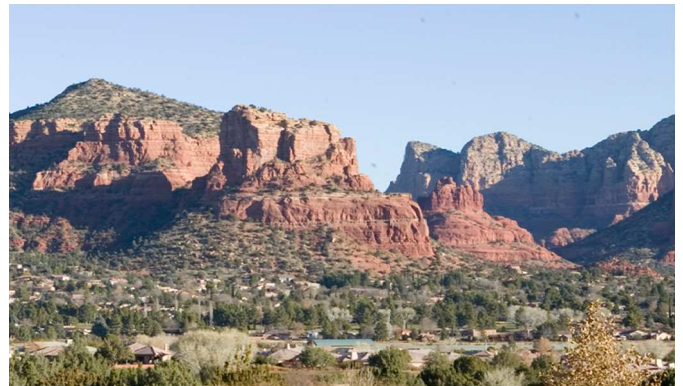

Rain Bird® GSP Services' rental units provide end users with low cost options to prevent or reduce downtime situations. Our rental kits allow service providers to certify the installation of Rain Bird central control systems and components in order to meet Rain Bird's specification standards and ensure optimal performance.

SITE SURVEY KITS

LINK™ SITE SURVEY KIT

Part Number: GSP700106

This kit includes everything necessary to conduct a thorough site survey to determine if a proposed location/site can implement a LINK communications infrastructure. The kit includes instructions for use. It is recommended that the user has taken the Wireless Technican class available through the Rain Bird Training Department.



MRLK SITE SURVEY KIT

Part Number: GSP700107

This kit includes everything necessary to conduct a thorough site survey to determine if a proposed location/site can implement a MRLK radio system. The kit includes instructions for use. It is recommended that the user has taken the Wireless Technican class available through the Rain Bird Training Department.



LINK 900 SITE SURVEY KIT

Part Number: GSP700110

This kit includes everything necessary to conduct a thorough site survey to determine if a proposed location/site can implement a LINK900 communications infrastructure. The kit includes instructions for use. It is recommended that the user has taken the Wireless Technican class available through the Rain Bird Training Department.



ISS SITE SURVEY KIT

Part Number: GSP700108

This kit includes everything necessary to conduct a thorough site survey to determine if a proposed location/site can implement an Integrated Sensor System. The kit includes instructions for use. It is recommended that the user has taken the Wireless Technican class available through the Rain Bird Training Department.





ROTOR DISTRIBUTION UNIFORMITY KIT

Part Number: GSP700108

This kit includes everything necessary to conduct a rotor distribution uniformity audit, as required for CGIA and CLIA certification. It is recommended that the user has taken the CGIA or CLIA certification class available through the Rain Bird Training Department.



Central Control Equipment			
Service Part Name	Service Part Number		Description
30-Day Loaner MIM™ or MIM-LINK™	GSP700100		Loaner will be sent via next day air service to requested site. This service is included free of charge for customers with a current Standard or Classic/PLUS Global Service Plan.
30-Day Loaner LDI/SDI/MDI™	GSP700101		
30-Day Loaner Computer Tower	GSP700102		

CENTRAL CONTROL COMPUTER REPLACEMENT PARTS



When an out-of-warranty situation exists, save time and avoid hassle with a quick call to Rain Bird® GSP Services for central control computer components. All replacement components are OEM certified for guaranteed compatibility. Courtesy overnight shipping ensures that your central control computer is quickly operational again.

Repair and Replacement Items

Service Part Name	Service Part Number	Description
Replacement Computer	GSP700330	For Golf Systems, Site Control or Maxicom
Computer Motherboard	GSP700320	Replacement mother board for Rain Bird central control computer (Golf & Commercial)
Computer Power Supply	GSP700315	Replacement power supply for Rain Bird central control computer (Golf & Commercial)
Edgeport	GSP700327	USB to serial adapter
Modem	GSPMODEM	USB or serial

The Intelligent Use of Water™

LEADERSHIP EDUCATION PARTNERSHIPS PRODUCTS

At Rain Bird, we believe it is our responsibility to develop products and technologies that use water efficiently. Our commitment also extends to education, training and services for our industry and our communities.

The need to conserve water has never been greater. We want to do even more, and with your help, we can. Visit www.rainbird.com for more information about The Intelligent Use of Water.™



Rain Bird Corporation
6991 E. Southpoint Road
Tucson, AZ 85756
Phone: (520) 741-6100
Fax: (520) 741-6522

www.rainbird.com

Rain Bird Corporation
970 West Sierra Madre Avenue
Azusa, CA 91702
Phone: (626) 812-3400
Fax: (626) 812-3411

Rain Bird Corporation
GSP Services
6991 E. Southpoint Road
Tucson, AZ 85756
Phone: (866) GSP-XPRT
Fax: (866) 429-5708
Email: gsp@rainbird.com
Email: gspservicerequests@rainbird.com
www.rainbird.com/gsp