

GROUNDING FOR 2-WIRE SYSTEMS



Step 1

Ground the Controller

Step 2

Connect the **2-Wire
Module** to a
Grounding System

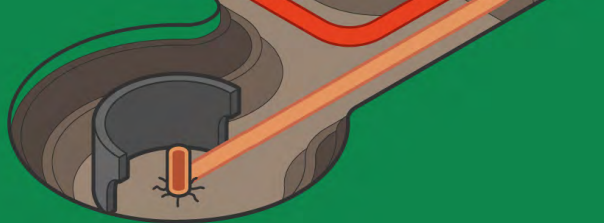

Step 3

Connect the **end of
each Star Path** to a
Grounding System

Step 4

Connect the **2-wire
Path** to a Grounding
System

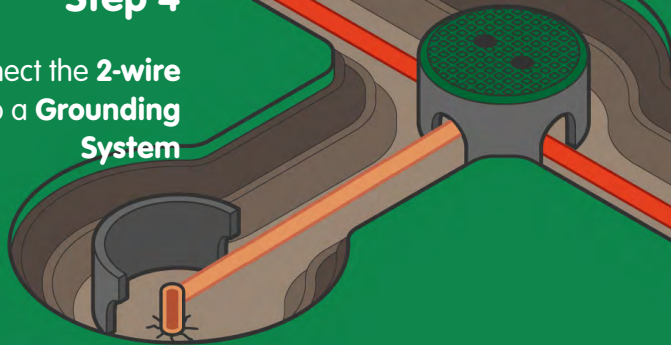

RAIN BIRD

Introduction

The Importance of Grounding

Ground Resistance: Understanding the Basics

Grounding Overview

Connecting a 2-wire System to ground

Grounding System Design

Additional Grounding Techniques

Maintenance

The Importance of Grounding

A grounding system discharges lightning-induced electrical current into the earth rather than allow the surge to pass through power wires or field wires to your equipment's electronic components.

Proper surge protection and grounding can help prevent damage to the controller and irrigation system and also significantly reduce troubleshooting, repair time and expense.

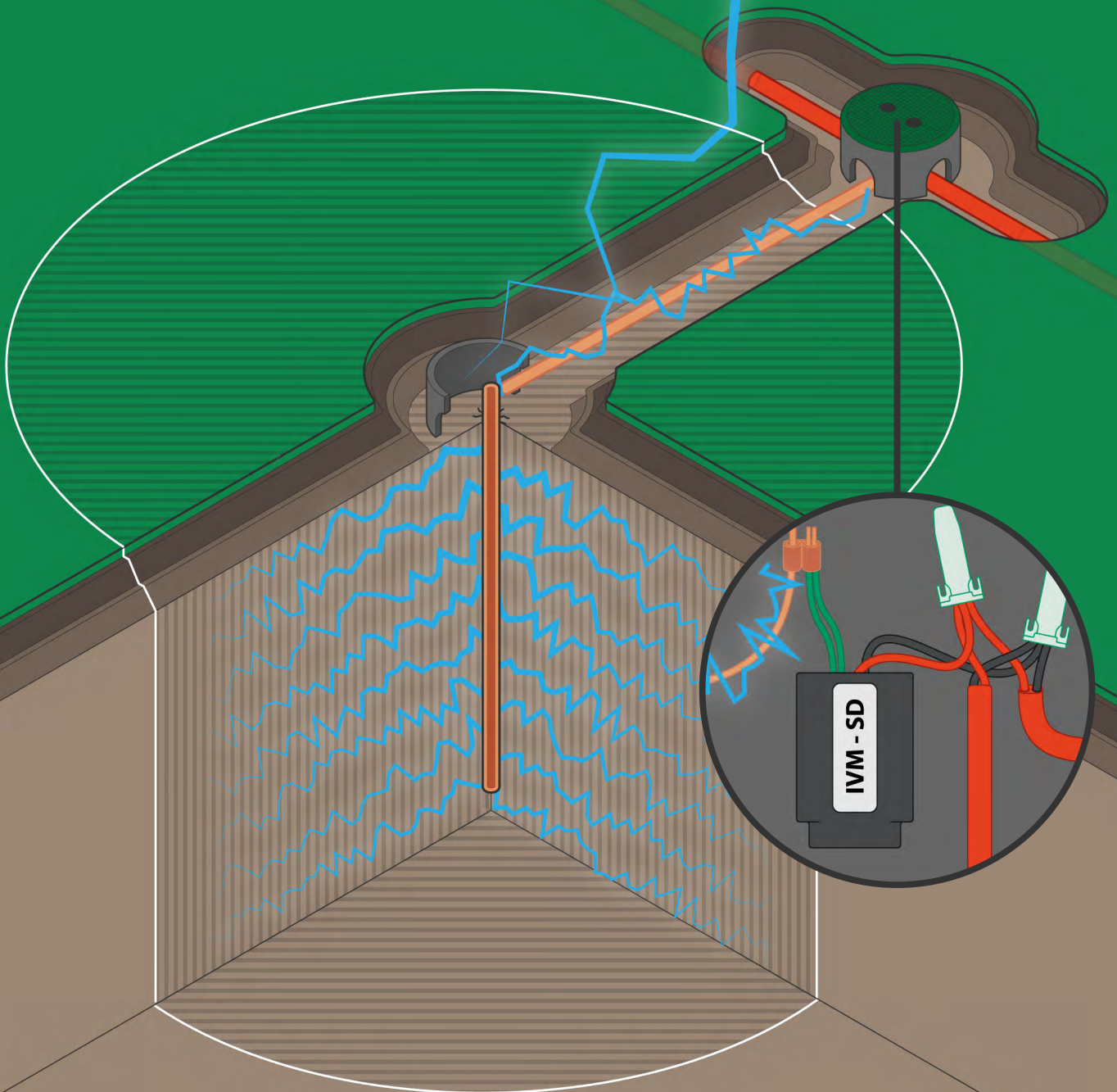

⚠ WARNING

Failure to properly ground your 2-wire system could result in failure of the controller and voiding the warranty. Ensure that all grounding devices are compliant with local electrical codes.

Ground Resistance: Understanding the Basics

Ground resistance occurs when grounding system components, or the soil itself, oppose the flow of electricity into the earth. Ground resistance is measured in units called “ohms” (Ω).

The higher the ground resistance (higher ohm readings), the less chance the surge will be shunted to ground rather than to the equipment’s electronic components.

Ground resistance can be measured using a ground resistance tester like the Megger DET3TC.

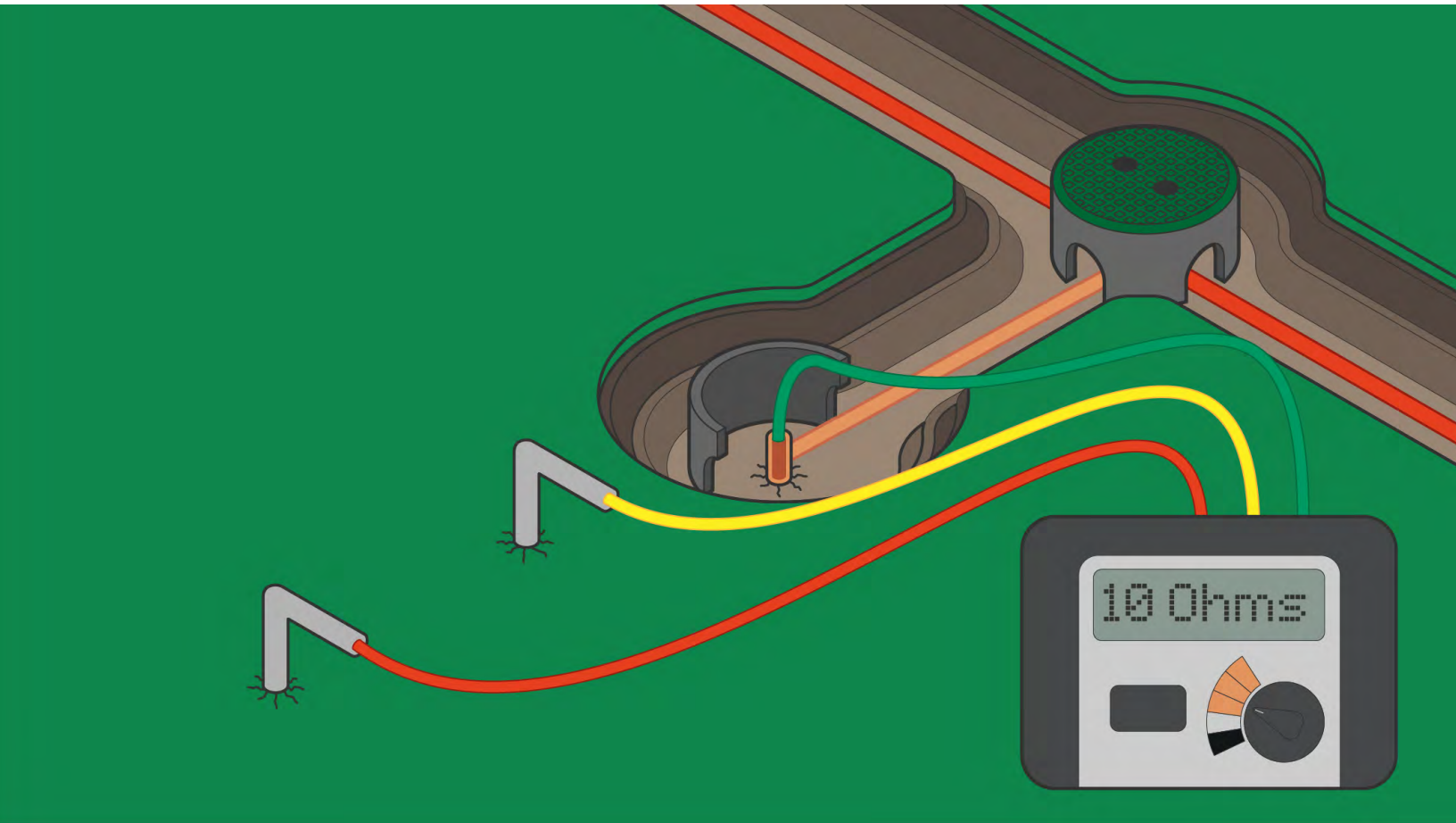

IMPORTANT

A properly installed grounding system should maintain a **ground resistance of 10 ohms or less.**

Introduction

Grounding Overview

LX-IVM Components

ESP-LXD Components

Grounding Rods

Grounding Plates

Restricted Spaces

Connecting to Ground

Grounding System Design

Additional Grounding Techniques

Maintenance



LXIVM Components

Require Grounding

Controller ESP-LX-IVM

The ESP-LX-IVM Controller is protected against electrical surges through the ground provided by the primary ground of the incoming power to the controller.

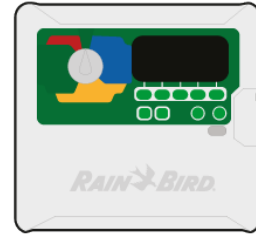

Field Devices - IVM-SOL, IVM-OUT, IVM-SEN

Field Devices are installed along the 2-Wire path to interface with valves and other hardware. The two wire path must be connected to a grounding system using an IVM-SD every 15 field devices or 500ft.

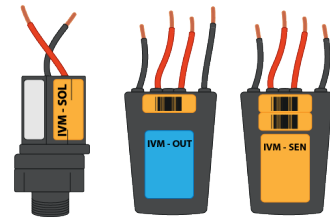

Connects to a Grounding System

Interface Module

The IVM 2-Wire Interface Module is connected to a grounding system, and to the grounding lug in the IVM cabinet.

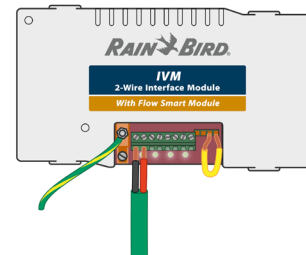

Surge Device - IVM-SD

The IVM-SD Surge Device is used to connect the 2-wire path to a grounding system.



ESP-LXD Components

Require Grounding

Controller ESP-LXD

The ESP-LXD Controller is protected against electrical surges through the ground provided by the primary ground of the incoming power to the controller.

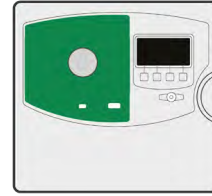

Decoders SD-211, FD-101, FD-202, FD-102

Decoders are installed along the 2-Wire path to interface with valves and other hardware. The two wire path must be connected to a grounding device using a surge device every 8 field devices or 500ft.

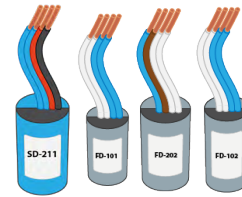

Connects to a Grounding System

Interface Module - ESP-LXD-M50

As well as connecting the ESP-LXD controller to the 2-Wire path, the M50 2-Wire Interface Module is connected to a grounding system and to the grounding lug in the ESP-LXD cabinet.

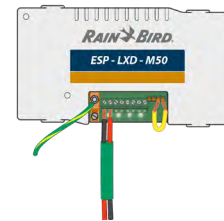

Decoders with integrated surge protection - FD-401, FD-601

The FD-401 and FD-601 have integrated surge protection meaning they can connect hardware to the 2-wire path as well as to a grounding system.

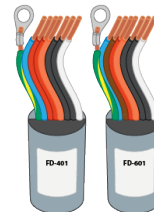

Surge Device - LSP-1

The LSP-1 Surge Device is used to connect the 2-wire path to a grounding system.



Grounding Rods

Grounding rods should be at least **5/8" x 8'**, **copper clad** with **welded insulated conductor**, such as the 182000IC6 from Paige. Rods should be installed at a distance equal to or greater than their length from the 2-wire path or any electrical equipment.

For example: an 8ft rod must be installed at least 8ft from equipment.

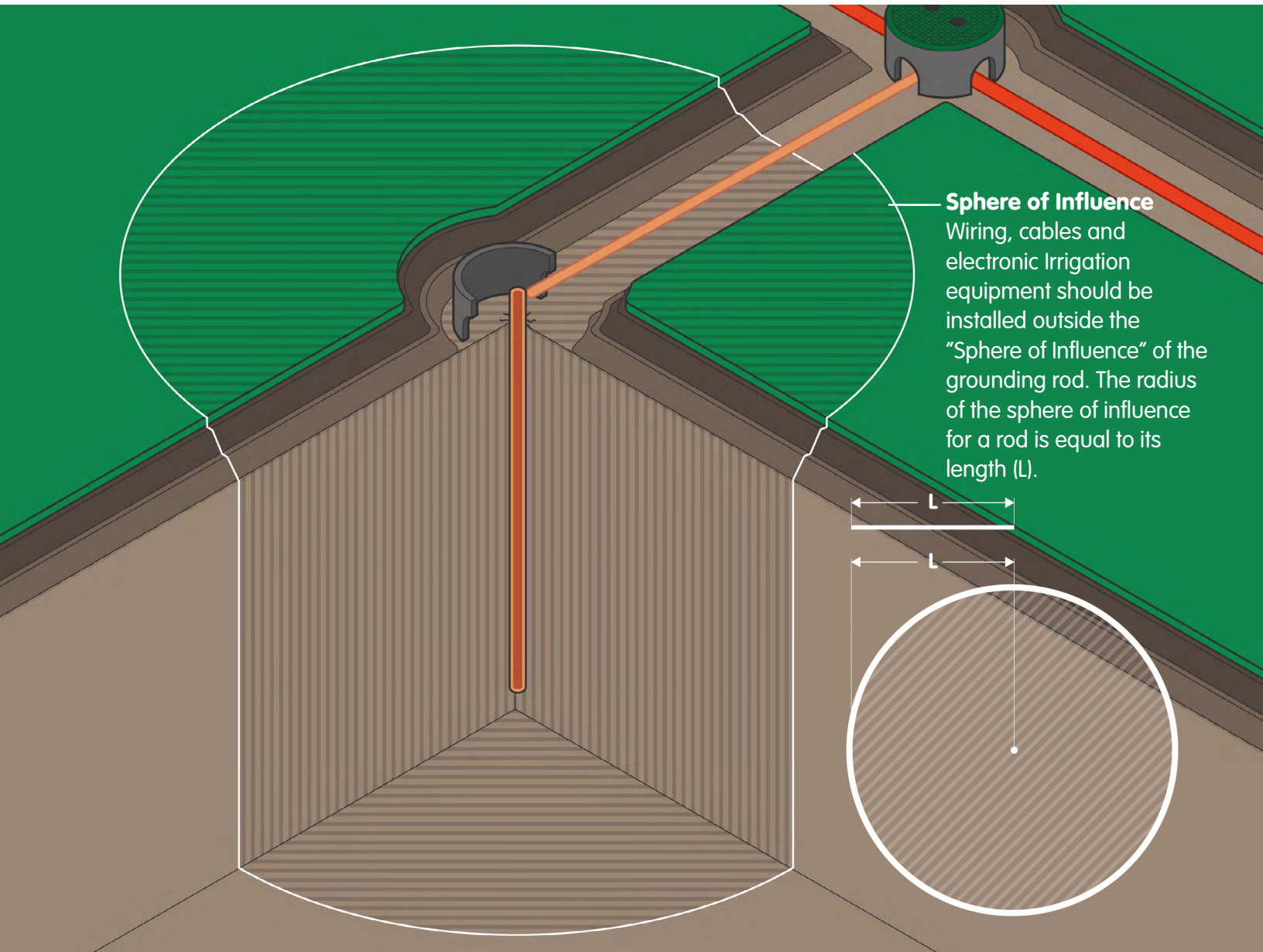

- 1** Install the connecting wire in as straight a line as possible. If you must make a turn or bend in the wire, make the turn in a sweeping curve with a minimum radius of eight inches and a minimum included angle of 90°.
- 2** To minimize resistance, the copper wire must be pre-welded to the grounding rods, or welded to the rods using an exothermic welding process at the site.

Grounding Plates

Grounding plates should be **copper clad** and **96" x 4"** with a **welded insulated conductor** such as the 182199IC from Paige.

The Sphere of Influence

Wiring, cables and electronic Irrigation equipment should be installed outside the "Sphere of Influence" of the grounding plate.

The Sphere of influence for a plate is equal to 3 times its length by 3 times its width.

e.g. a 96" x 4" plate would have a sphere of influence 288" x 12"

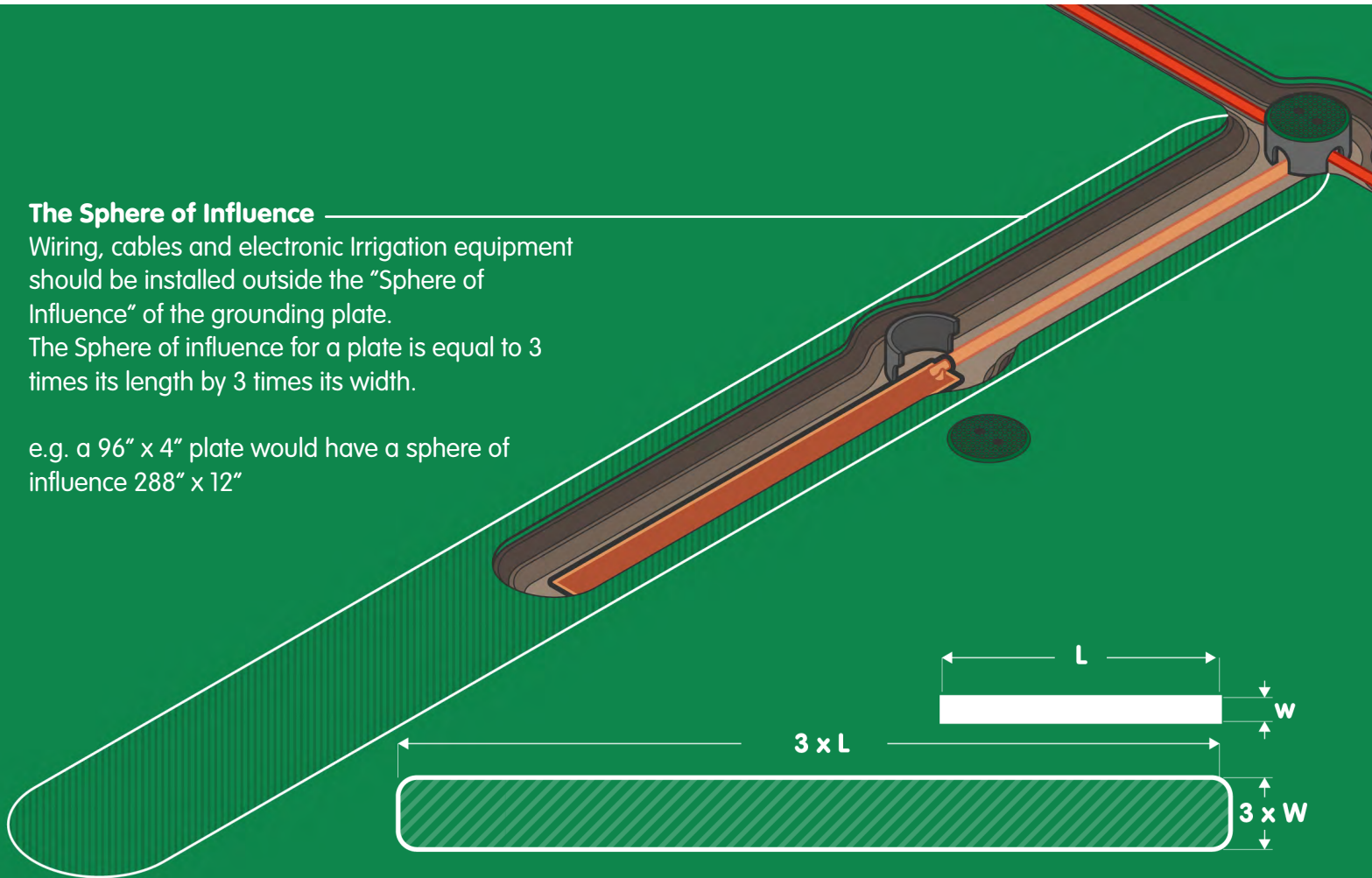

- 1 Install the connecting wire in as straight a line as possible. If you must make a turn or bend in the wire, make the turn in a sweeping curve with a minimum radius of eight inches and a minimum included angle of 90°.
- 2 To minimize resistance, the copper wire must be pre-welded to the grounding plates, or welded to the plates using an exothermic welding process at the site.

Restricted Spaces

Some grounding is better than no grounding. Rain Bird highly recommends some form of grounding is still installed even if there is a lack of space or obstacles (such as a road).

Below grounding plates are shown installed parallel to the 2-wire path, so that any overlap between the sphere of influence and electrical equipment is minimized. The lower image shows a plate installed on its side.

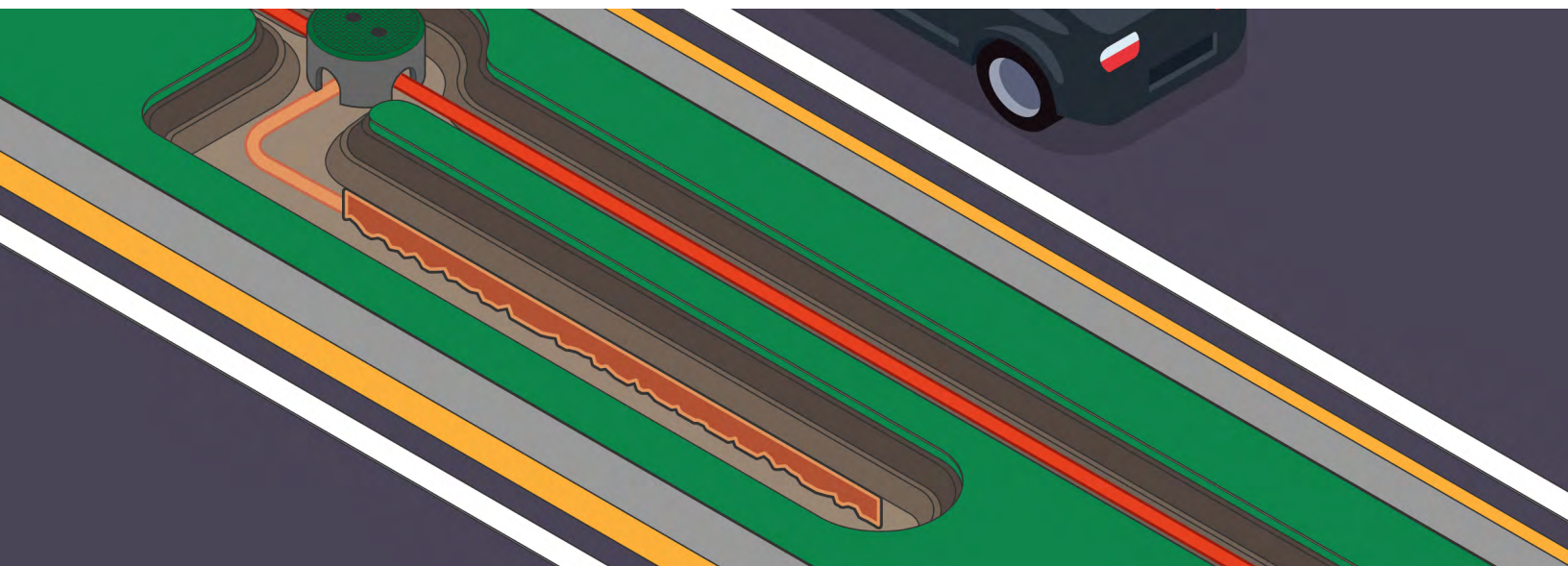
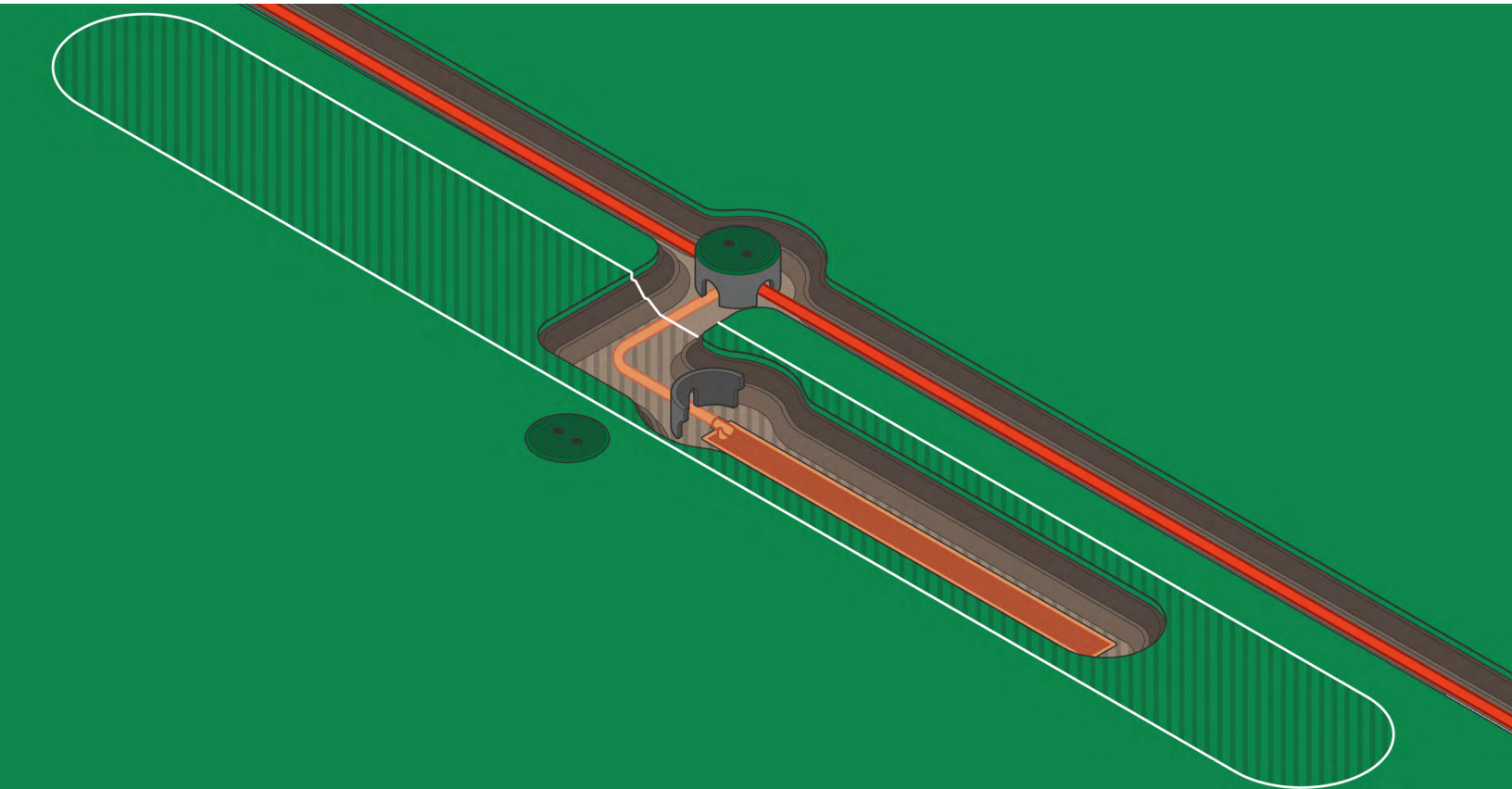

Introduction

Grounding Overview

Connecting to Ground

Step 1 Grounding the Controller

Step 2 Grounding the 2-Wire Module

Step 3 Connect the end of each Star Path

Step 4 Connect the 2-wire Path

Grounding System Designs

Additional Grounding Techniques

Maintenance



Step 1

Ground the Controller

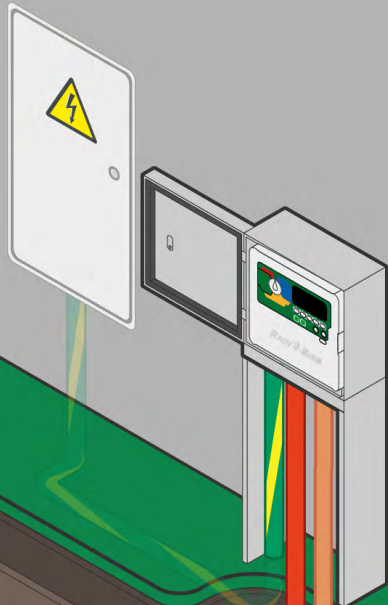

Step 2

Connect the **2-Wire Module** to a **Grounding System**

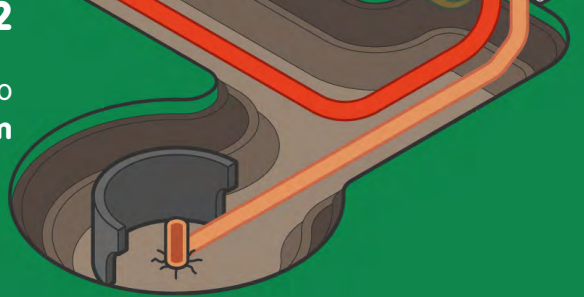

Step 3

Connect the **end of each Star Path** to a **Grounding System**

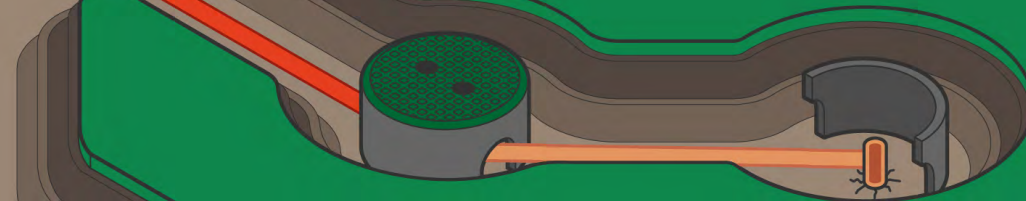

Step 4

Connect the **2-wire Path** to a **Grounding System**

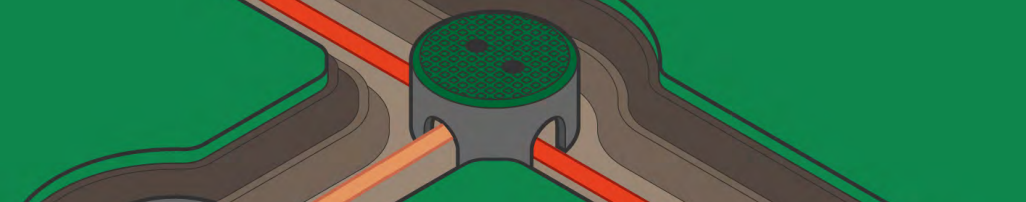

Step 1 - **Grounding the Controller**

The LX-IVM or ESP-LXD Decoder Controllers are protected against electrical surges through the ground provided by the primary ground of the incoming power to the controller.

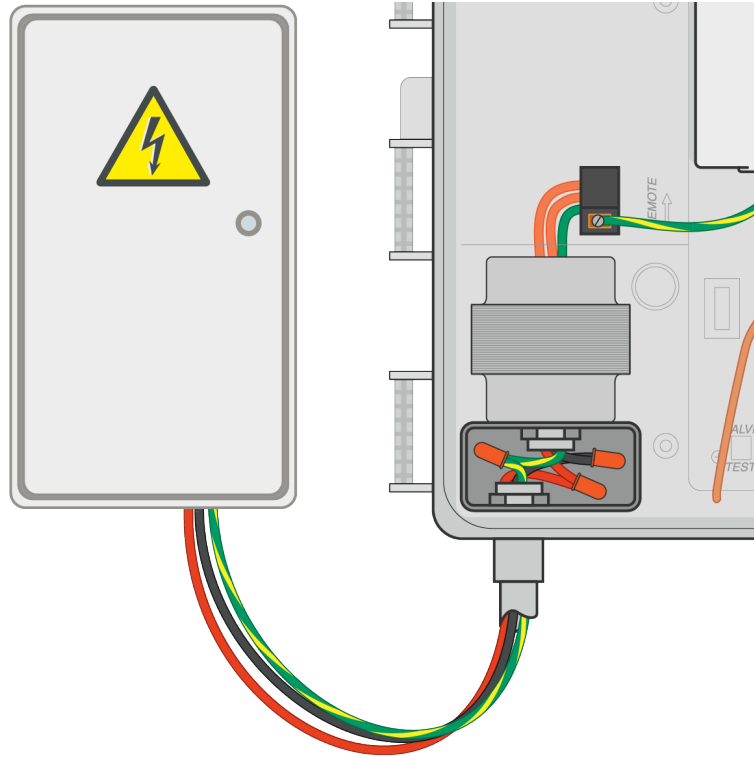

NOTE

If the primary power ground does not provide 10 Ohms resistance or less to ground, the transformer ground wire should be connected to a local ground rod or clamp that provides the 10 Ohms resistance or less to ground

Step 2- **Grounding the 2-Wire Module**

- 1 Connect #6AWG copper wire to the M50 (ESP-LXD), or IVM 2-Wire (LX-IVM) Interface Module ground lug.
- 2 Connect the other end of the ground wire to a grounding system with a resistance to ground of 10 ohms or less.

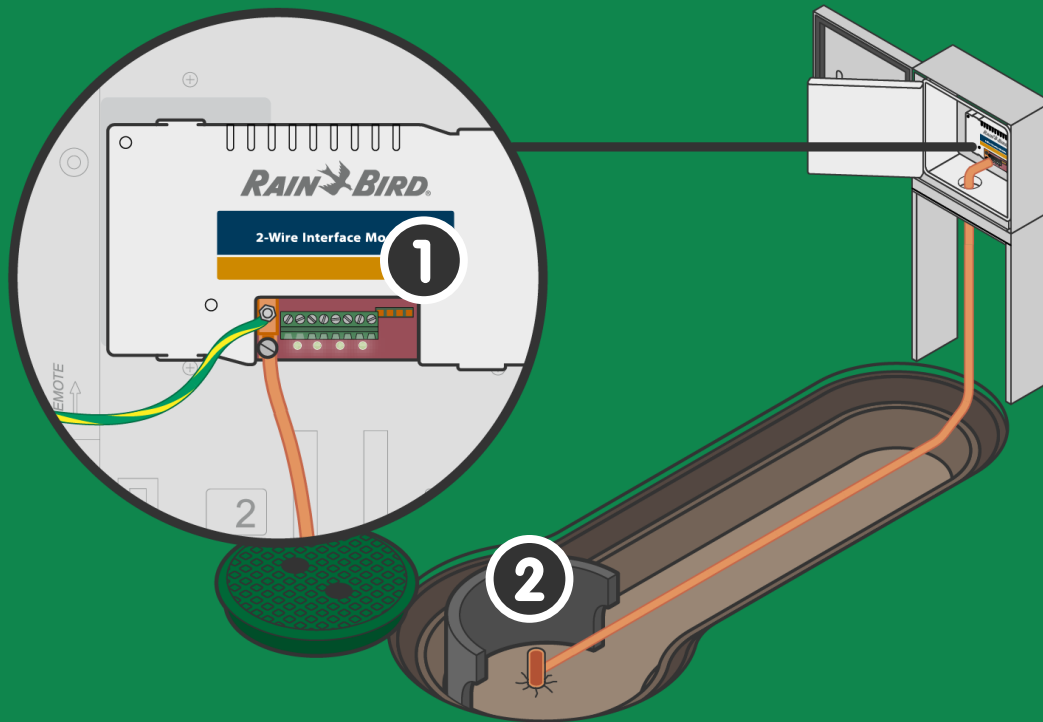

Step 3 - **Ground each Star Path**

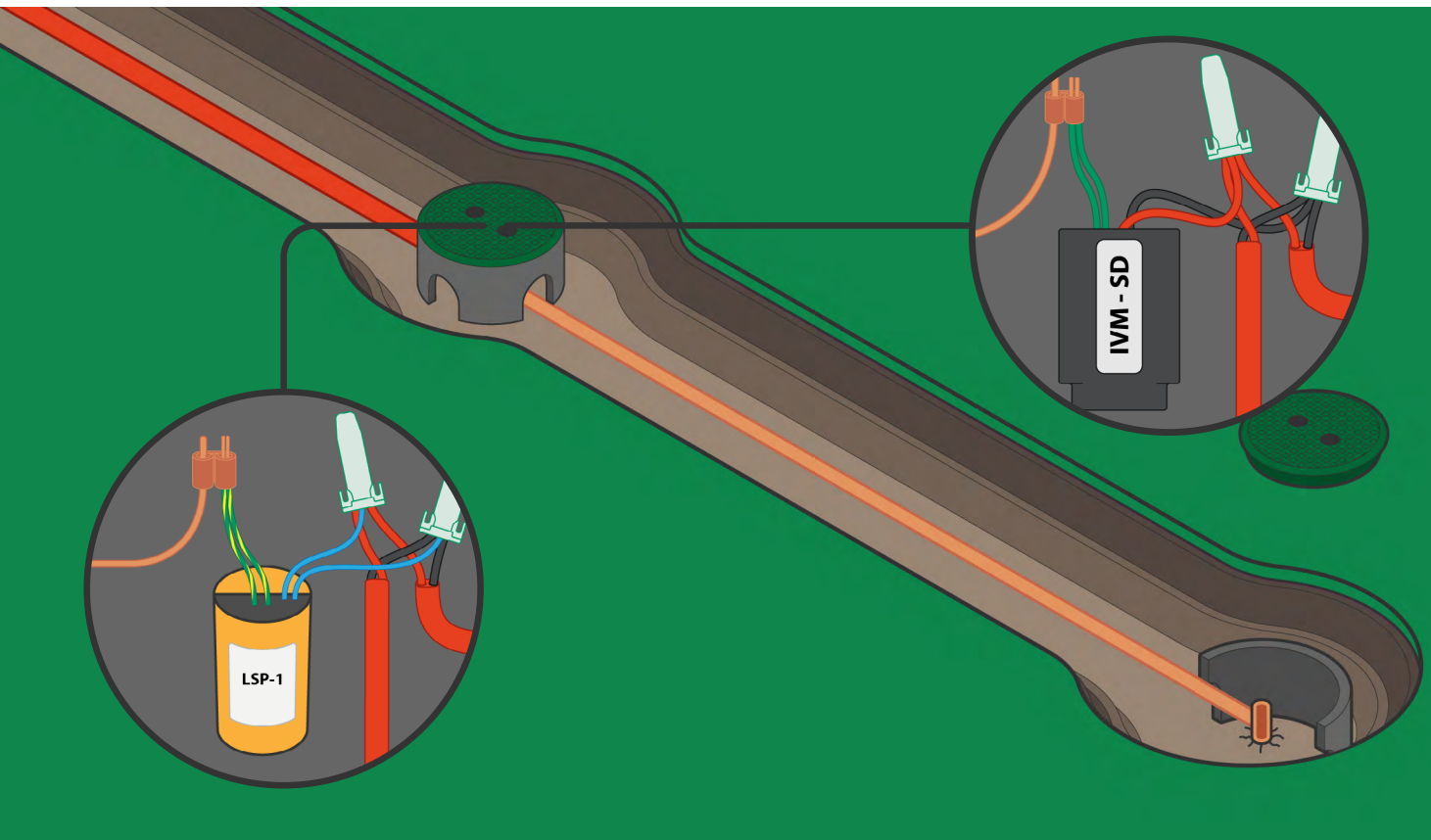

For 2-Wire paths in a “Star” configuration, each path must be terminated with a surge device (LX-IVM: IVM-SD, ESP-LXD: LSP-1, FD-401 or FD601) connected to a grounding system.

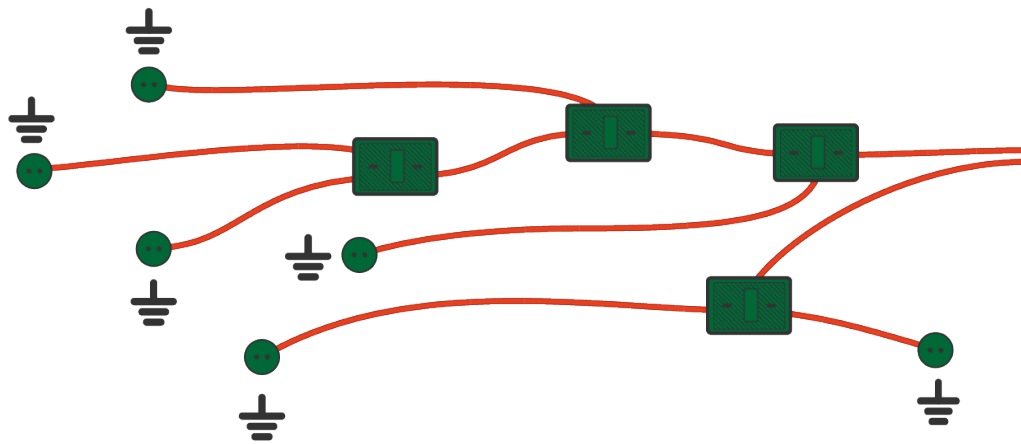

⏏ = Grounding System

Step 4 - Ground the 2-Wire Path

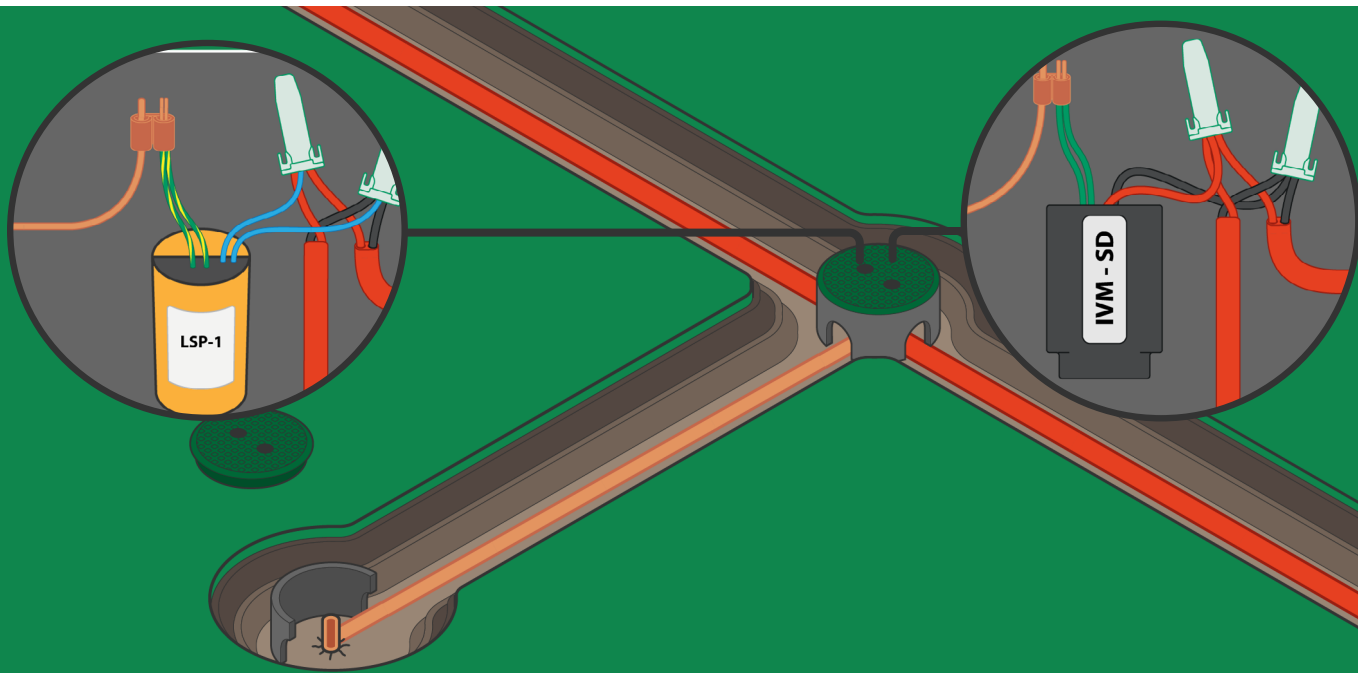

The 2-Wire path must be **surge protected with** a surge device (LX-IVM: IVM-SD, ESP-LXD: LSP-1, FD-401 or FD601) and connected to a grounding system every **500 feet** or every **15 field devices (LX-IVM)/ 8 field devices (ESP-LXD)**, whichever comes first.

LX-IVM & ESP-LXD

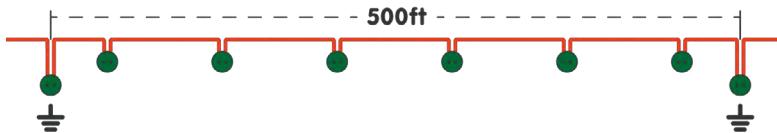

LX-IVM

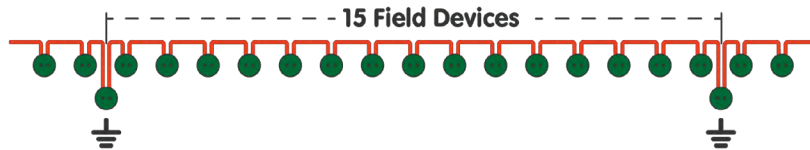

ESP-LXD

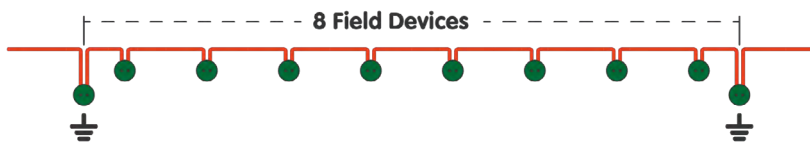

Introduction

Grounding Overview

Connecting to Ground

Grounding System Designs

Single Grounding Rod

Single Grounding Plate

“Y” Grid

Additional Grounding Techniques

Maintenance



Grounding System Design 1: **Single Grounding Rod**

Grounding rods should be at least 5/8" x 8' copper clad with welded insulated conductor, such as the 182000IC6 from Paige. Rods should be installed at a distance equal to or greater than their length from the 2-wire path or any electrical equipment.

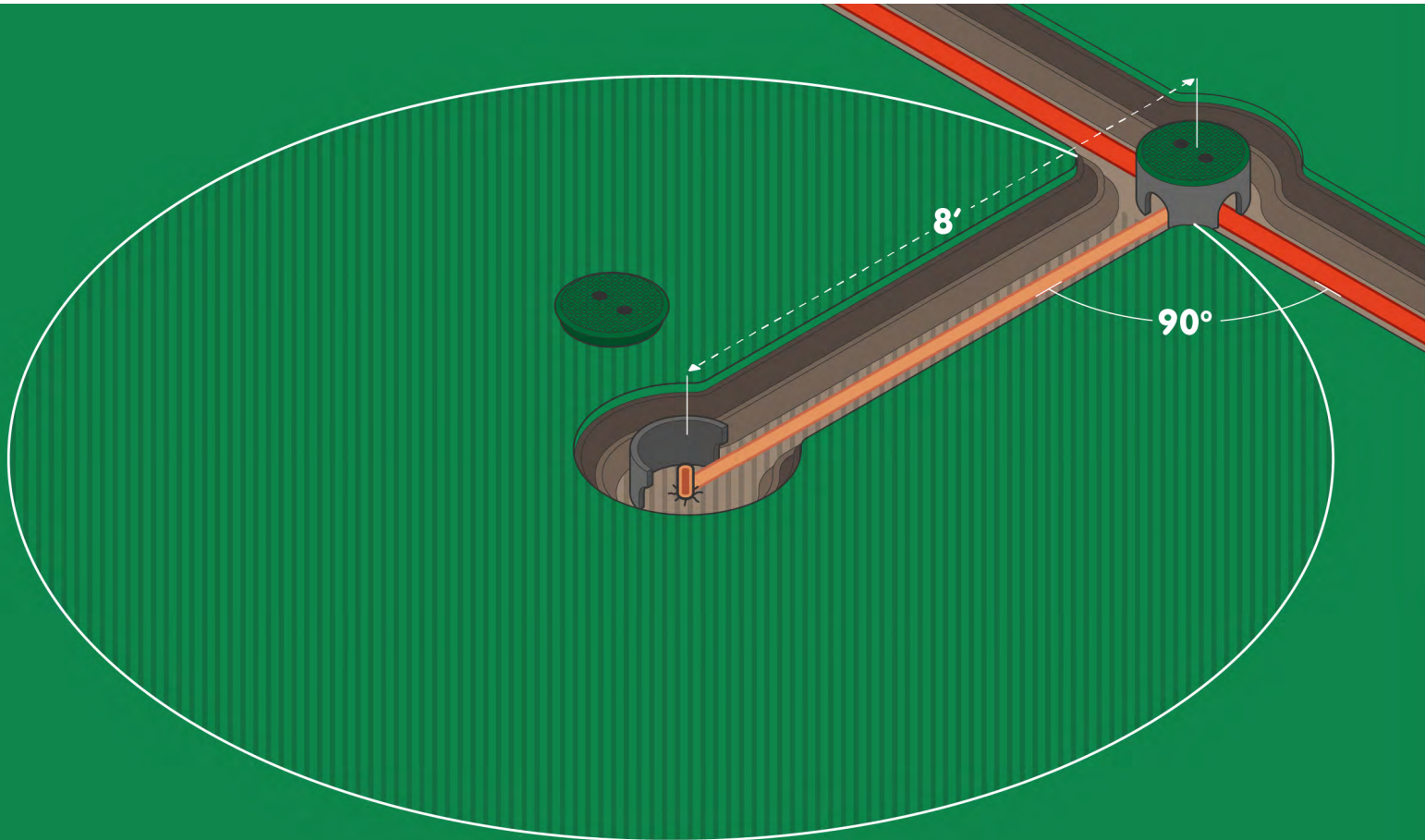

IMPORTANT

A properly installed grounding system should maintain a **ground resistance of 10 ohms or less.**

If you need to reduce the ground resistance further you can try:

- 1 Ground Rod Stacking
- 2 Ground Enhancement
- 3 "Y" Grid Design

Grounding System Design 2: **Single Grounding Plate**

If there is risk of hitting underground pipes or wires when driving ground rods, a copper clad 8 foot x 5/8 inch grounding plate can be used instead provided it maintains 10 ohms or less of resistance. Grounding plates should be installed 30" below grade.

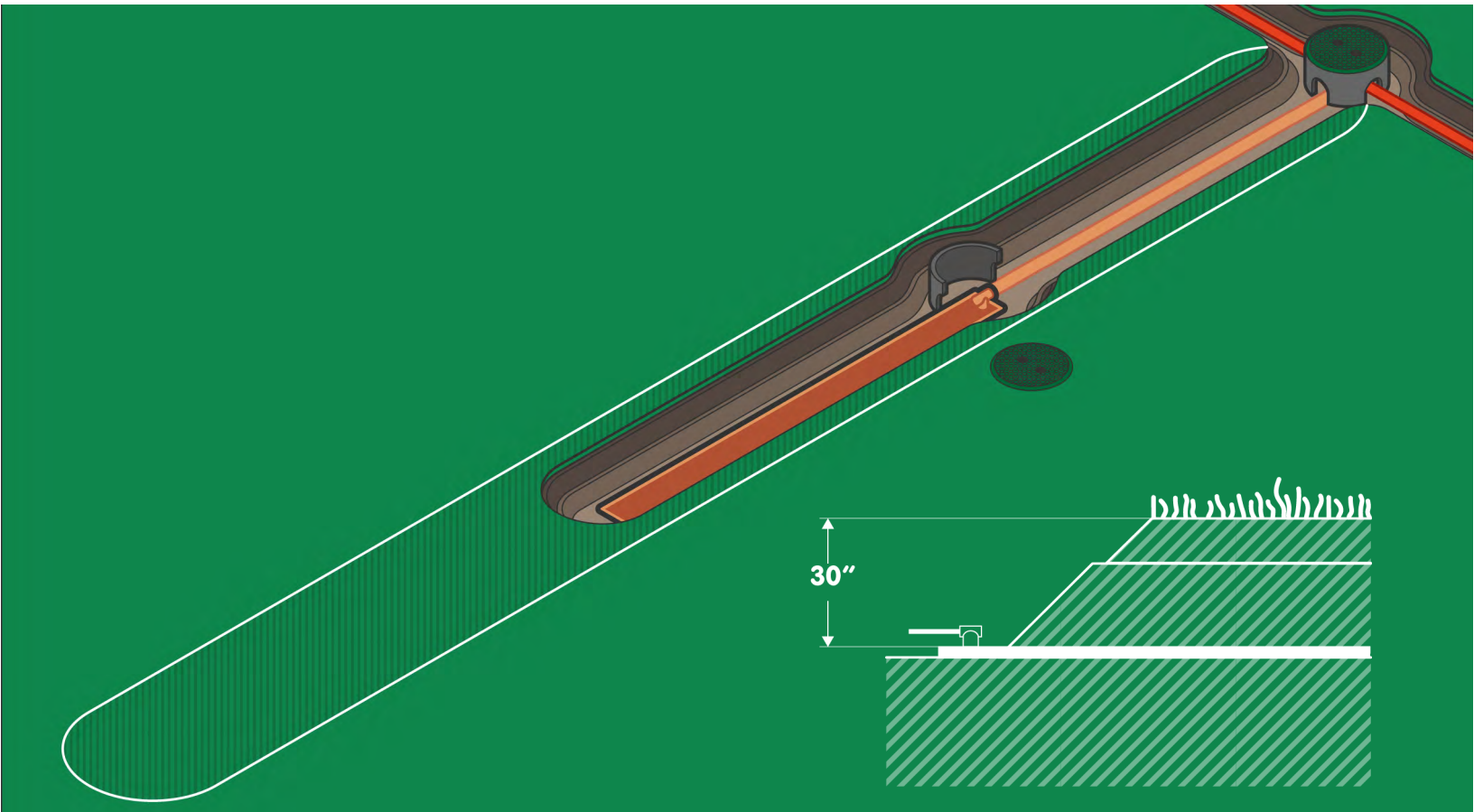

IMPORTANT

A properly installed grounding system should maintain a **ground resistance of 10 ohms or less.**

If you need to reduce the ground resistance further you can try:

- 1 Ground enhancement material
- 2 Add additional plates

Grounding System Design 3: "Y" Grid

This grounding grid uses three, 5/8"-diameter x 8-foot-long grounding rods installed in a radial 120° "Y-shaped" configuration.

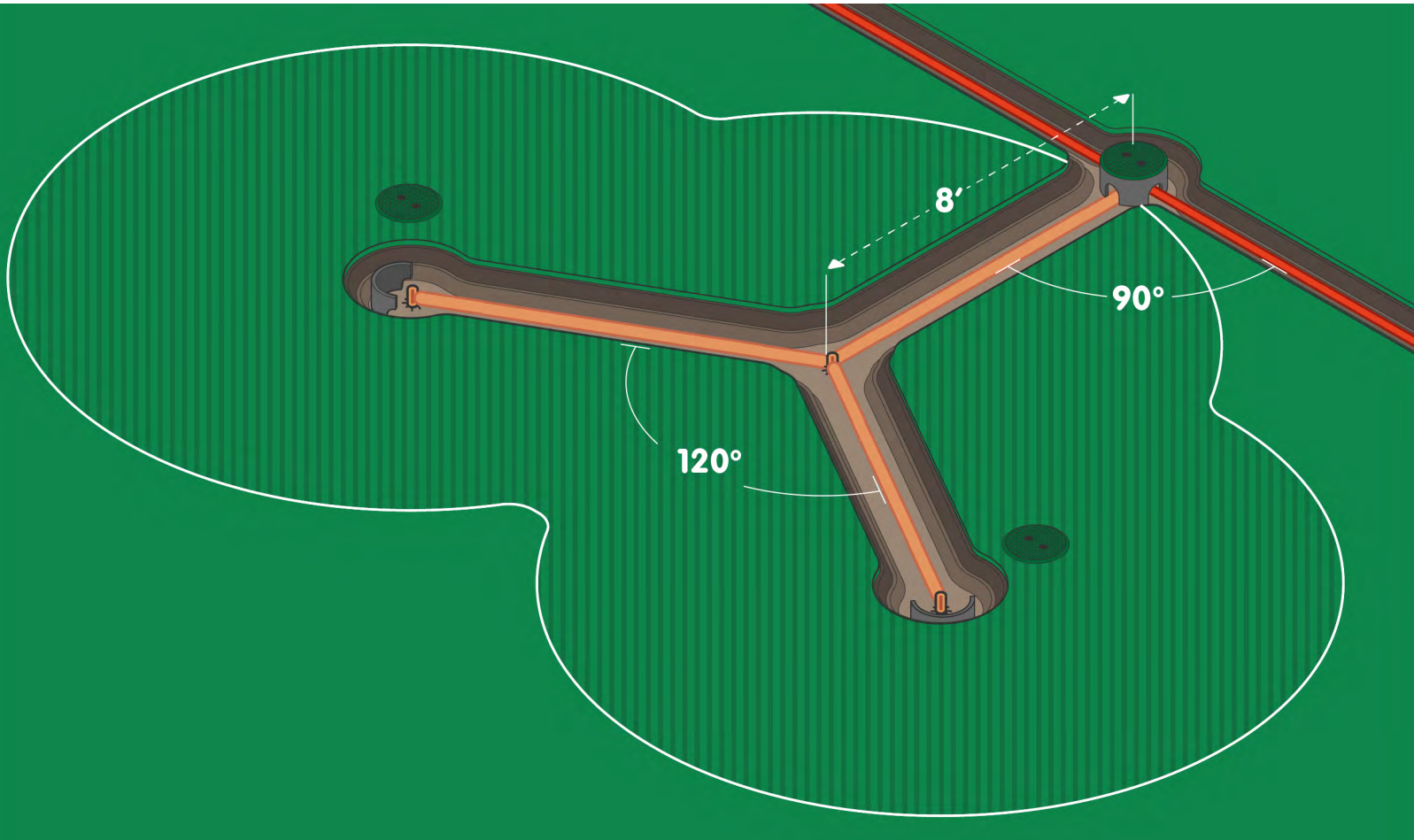

Install the rods in a radial 120° star ("Y") configuration. Each rod must be installed in a true vertical position, at a distance equal to or greater than their length from the 2-wire path or any electrical equipment. Connections between the rods should be made with 6AWG copper cable welded with a exothermic connectors like a Cadweld.

IMPORTANT

A properly installed grounding system should maintain a **ground resistance of 10 ohms or less.**

If you need to reduce the ground resistance further you can try:

- 1 Ground rod stacking
- 2 Ground enhancement material

Introduction

Grounding Overview

Connecting to Ground

Grounding System Designs

Additional Grounding Techniques

Maintenance

ADDITIONAL TECHNIQUES TO LOWER GROUND RESISTANCE

Ground Enhancement Material for Rocky or Sandy Soil

If you are unable to reach a resistance of 10 ohms or less, you can decrease resistance by surrounding the grounding rods or plates with ground enhancement material, such as POWER SET from Paige Electric Corporation (P/N 1820058), or GEM from ERICO (P/N GEM-25A).

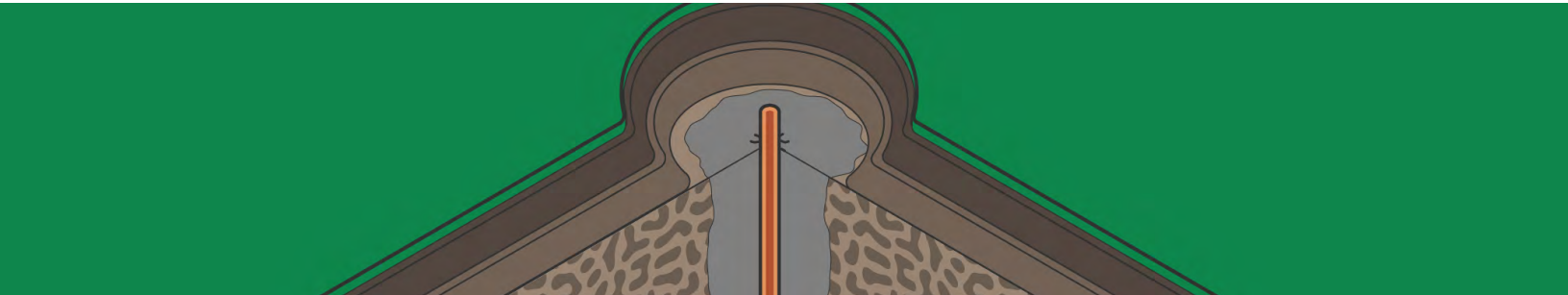

Dry Soil

Moist soil provides lower resistance than dry soil. To decrease ground resistance, Rain Bird recommends irrigating the soil around the grounding system. Each grounding system should have a dedicated irrigation zone with sprinkler heads and its own watering program to maintain soil moisture around the grounding system.

Install the ground rod or plate in an irrigated area if possible. Adding emitters or bubblers to wet the soil around the rod or plate in non-irrigated areas may be required.

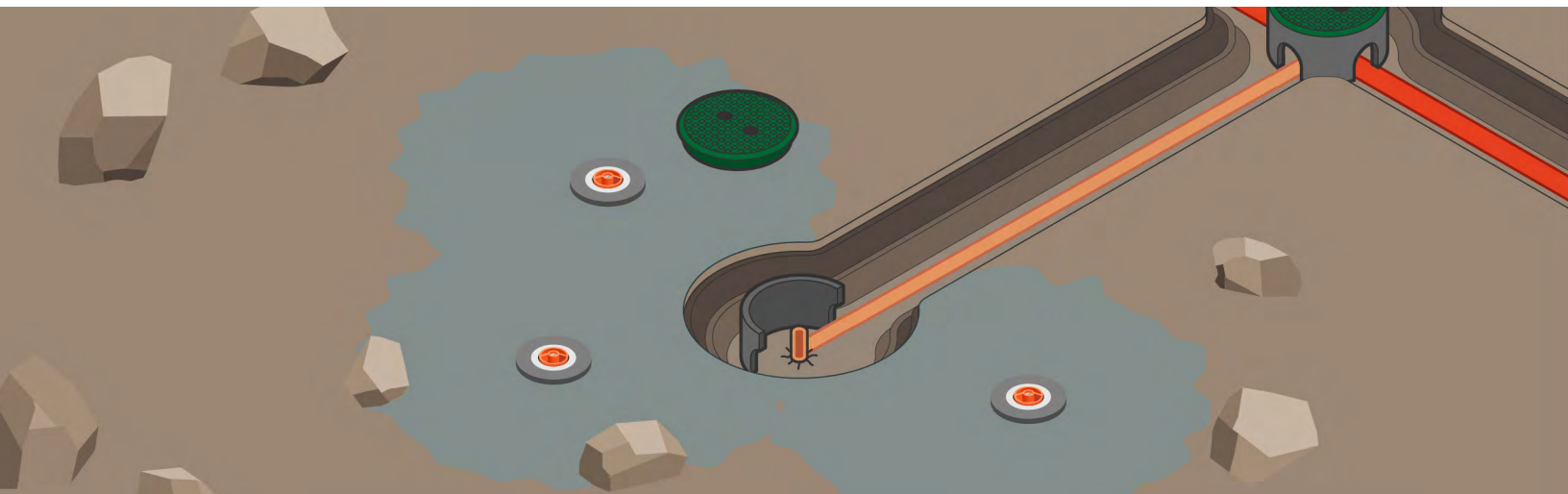

Ground Rod Stacking

Ground Rod Stacking threaded couplers are ground rod splices.



If a single grounding rod fails to produce 10-ohm or less ground resistance, threaded couplers can be used to “stack” grounding rods.

Stacking ground rods increases the total effective rod length, decreasing ground resistance.

Joining the rods together with threaded couplers forms a secure connection so the grounding rods can be assembled quickly and easily.

IMPORTANT

Use threaded couplers made of the same material as your grounding rods.

Introduction

Grounding Overview

Connecting a 2-wire System to ground

Grounding System Designs

Additional Grounding Techniques

Maintenance

MAINTENANCE

Measure the ground resistance around the grounding system after installation, and once every year after. Grounding connectors should be accessible via valve box for yearly testing with a ground resistance tester like the Megger DET3TC.

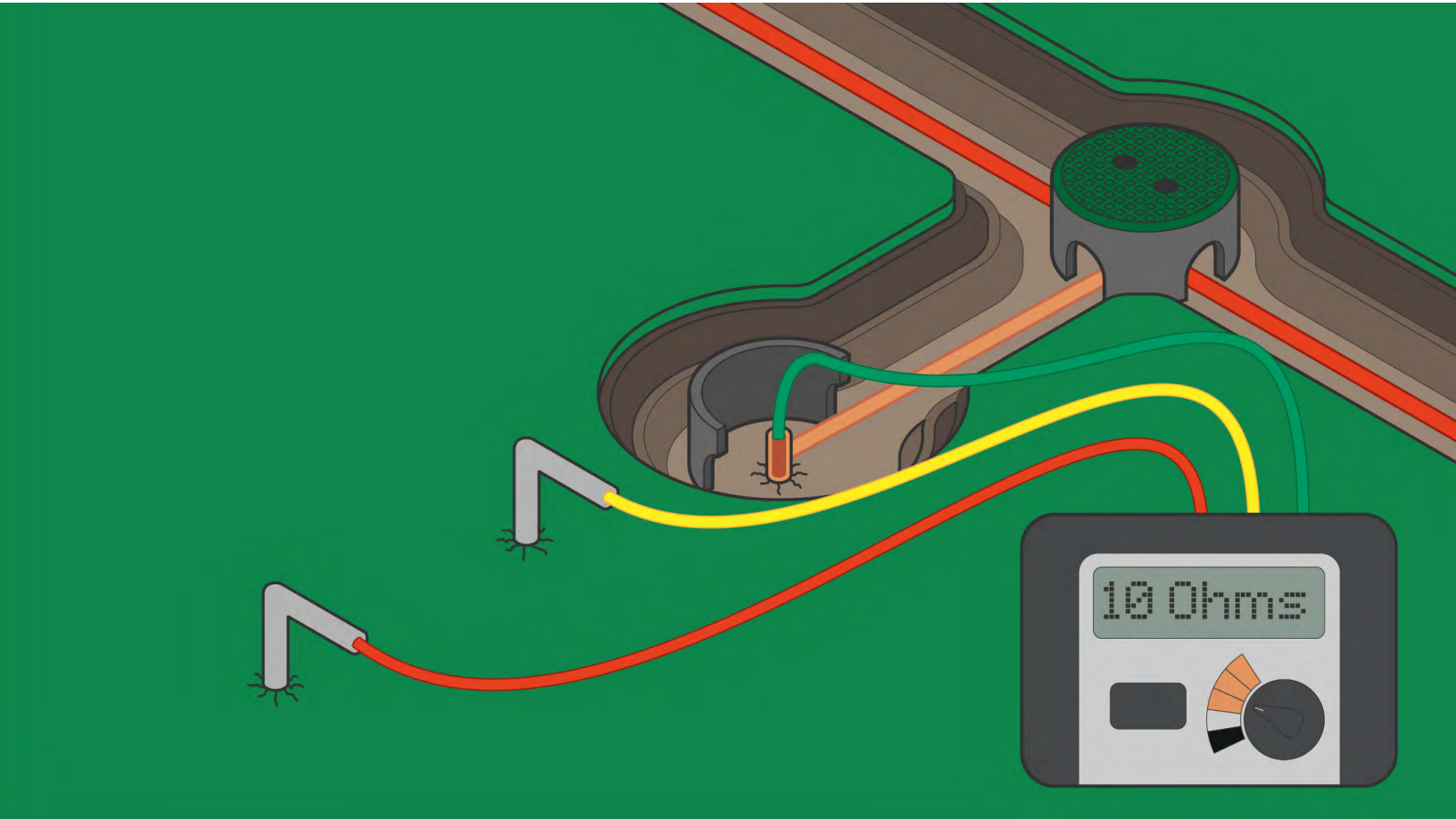

Inspect the grounding system's clamped connections to the equipment (not the welded grounding system connections) once a year to make sure they are secure and corrosion-free.