

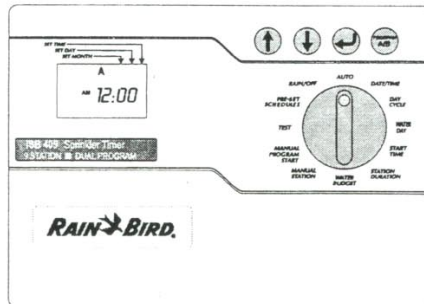

## ISB 409 Sprinkler Timer

### Installation, Programming, and Operation Guide



RAIN BIRD SALES, INC. — Consumer Products Division  
7590 Britannia Court, San Diego, California 92173, U.S.A.  
(800) 724-6247

Technical Services: 800-247-3782 • <http://www.rainbird.com>

P/N 634167

# Special Upgrade Offer

Save an extra 15% off new sprinkler timers and irrigation controllers at the Rain Bird Online Store.\*

Still struggling with your old sprinkler timer? Having a hard time complying with local watering restrictions? Upgrading to a new Rain Bird sprinkler timer is easier than you might think.

New timers are easier to program than ever before, with powerful features to help save you time and water while keeping your yard healthy and vibrant.

There are lots of models to meet your needs, including indoor and outdoor versions, flexible modular timers and even smart controllers that automatically adjust themselves based on the weather.

Shop Now at [store.rainbird.com](http://store.rainbird.com) and enjoy exclusive upgrade savings!



Enter discount code:

**UPGRADE15**

at checkout to save an extra 15% off\*

*\* Additional discount not valid on clearance items, bundles or store specials. Discount applies to controller products only. Cannot be combined with other store discount codes. Valid at the Rain Bird Online Store only. Subject to change without notice.*

**RAIN  BIRD®**

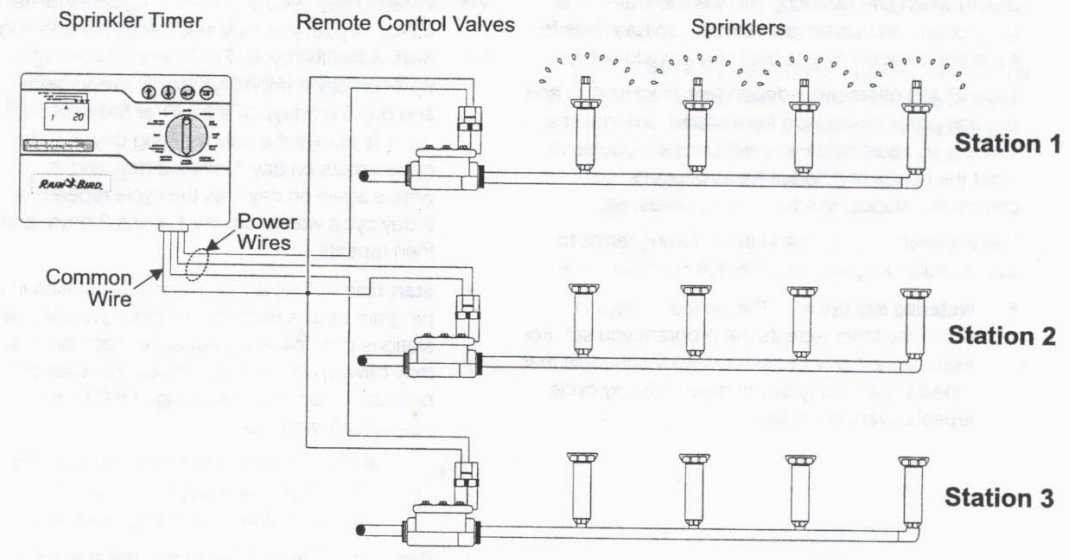

---

## What Is a Program?

Programming is the process of telling the timer exactly when and how long you want to water. The timer opens and closes the remote control valves for each station according to the program you set.

The ISB 409 offers two independent programs; A and B. Each program controls from one to nine stations, and lets you customize your watering schedules to meet the needs of different types of plants, soil conditions, slopes, shady or sunny areas, etc.

You will need to understand the following terms to successfully program your ISB 409 sprinkler timer.

- **Watering day cycle** — The period of days in which the timer repeats the program you set. For example, a 7-day cycle is a weekly schedule that repeats once every seven days. A 2-day cycle repeats every other day.
- **Watering days** — The specific days within the watering day cycle when watering takes place. In a 7-day cycle, you may select multiple watering days within the cycle. For example, you might water on day 1 (Monday), day 3 (Wednesday), and day 5 (Friday). In a 2-, 3-, or 5-day cycle, day 1 is always the only watering day. A 2-day cycle waters on day 1, skips a day, and then waters again on day 1 as the cycle repeats. A 3-day cycle waters on day 1, skips 2 days, and then repeats.
- **Start time** — This is the time the first station in a program begins watering. All other programmed stations then follow in sequence. Each program may have up to three start times. For example, a program could begin watering at 6:00 a.m., 12:00 noon, and 6:00 p.m.



**NOTE:** The term "start time" refers to the time the *program* begins — not the time each individual station begins to run.

- **Run time** — The number of minutes that each station runs.

## **SPRINKLER TIMER BASICS**

### **Programming Under Battery Power**

If you wish, you can program the timer under battery power. This feature can be useful if the timer is installed in an area that is not readily accessible. This feature also allows you to enter program information before installing the timer.

To program the ISB 409 sprinkler timer under battery power, you must first install the battery.



**NOTE:** To save battery power, the ISB 409 goes into "sleep" mode after 40 seconds of inactivity on the programming dial or buttons. Press any button once to reactivate the timer.

---

## Installing the Battery

The battery back-up feature retains time, date, and programming information during power outages. The battery also lets you program the timer under battery power before it is connected to an AC power supply.

For best results, use a long-life, 9-Volt alkaline battery. A new battery will normally provide power for up to one year. Replace the battery yearly to ensure an uninterrupted power supply.



**NOTE:** Make sure the timer is connected to an AC power supply when replacing the battery, or you will lose all programming information including date and time.

To install the battery:

1. Remove the timer's lower access cover to expose the battery compartment.
2. Snap the two-wire battery clip onto the terminals of the new battery. If you are replacing an old battery, dispose of the old battery properly.
3. Insert the new battery snugly into the battery compartment.
4. Replace the lower access cover.

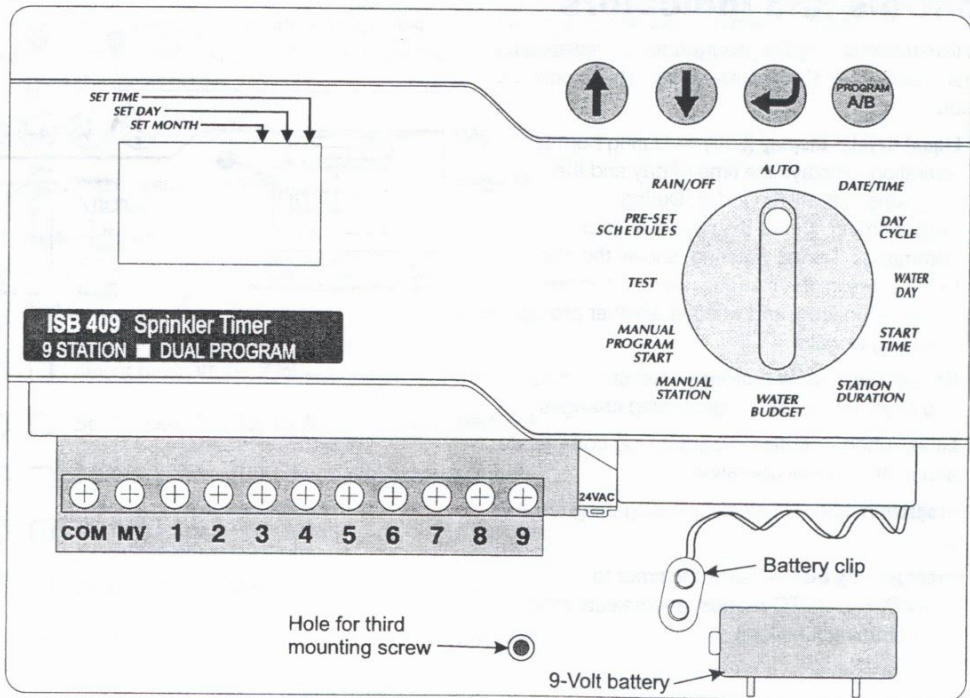

## Controls and Indicators

This illustration shows the programming controls on the face of the ISB 409 sprinkler timer. These controls include:

1. **Liquid Crystal Display (LCD)** — During normal operation, displays the time of day and the programs that will run today. During programming, shows the results of your commands. During watering, shows the station that is running, the minutes remaining in the station's run time, and whether another program is waiting to water.
2. **Up and Down arrow buttons** — Set start times and days, and make programming changes.
3. **Enter button** — Enters programming commands, and starts manual operation.
4. **Program button** — Selects watering program A or B.
5. **Programming Dial** — Turns the timer to RAIN/OFF or AUTO modes, and selects other programming functions.

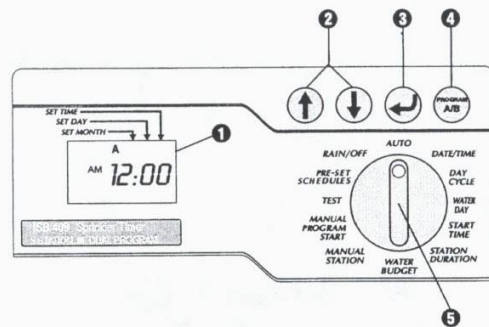



---

## Programming Checklist

To program your ISB 409 sprinkler timer for the first time, we recommend that you complete the following steps in the order listed below.

For your convenience, a check-off box () is provided for each step.

- Fill out the Programming Chart ..... page 10
- Set the current year/month/day/time ..... page 15

For each program:

A B

- Select pre-set schedules ..... page 18
- Select program (A or B) ..... page 19
- Set the watering day cycle ..... page 20
- Set the watering days ..... page 21
- Set the program start time(s) ..... page 23
- Set the station duration(s) ..... page 25
- Set the timer to automatic operation ..... page 27

## Sprinkler Timer Programming Chart

Before programming your ISB 409, fill out the Programming Chart included with your timer. Then program the timer in the order shown on the Programming Checklist.

1. Select the watering day cycle you wish to use, and circle the watering days within the cycle. In the example shown for program A, the operator has chosen a 7-day watering cycle and circled M, W, and F as watering days. This means that program A will water every Monday, Wednesday, and Friday.



**NOTE:** If you plan to use only one program for your watering needs, select program A.

2. For program B, the operator selected a 3-day watering cycle. With these selections, program B will water once, skip two days, and then water again on the first day of a new three day cycle.
3. You may also choose three special watering day cycles that do not require you to select watering days. These cycles are:

- **Ev** = Waters only on even-numbered days of the month.

- **Od** = Waters only on odd-numbered days of the month.
  - **Od31** = Waters only on odd-numbered days of the month, but not on the 31st of any month or on February 29. (This watering day cycle complies with special ordinances in some water-restricted areas).
4. In the Start Times box for program A, write the time you want the program to begin watering. You may assign up to three start times to each program. If you want the program to water only once each watering day, enter only one start time. Enter other start times only if you want to repeat the entire program more than once each watering day.
  5. Enter the start time(s) for program B (if any). In the example, Program A begins watering at 7 a.m. Program B begins watering twice each watering day, once at 5 a.m. and again at 3 p.m.



**PROGRAMMING CHART**  
For ISB Controllers

Technical Assistance: 800-247-3782

1 **Watering Days**

2

Program A	Program B
<input checked="" type="checkbox"/> M <input type="checkbox"/> T <input type="checkbox"/> W <input type="checkbox"/> T <input type="checkbox"/> F <input type="checkbox"/> S <input type="checkbox"/> S <input checked="" type="radio"/> 7-day cycle <input type="radio"/> even <input type="radio"/> odd <input type="radio"/> odd, no 31st	<input type="checkbox"/> M <input type="checkbox"/> T <input type="checkbox"/> W <input type="checkbox"/> T <input type="checkbox"/> F <input type="checkbox"/> S <input type="checkbox"/> S <input type="radio"/> 3-day cycle <input type="radio"/> even <input type="radio"/> odd <input type="radio"/> odd, no 31st
<b>3</b> 1 7:00 (am/pm) 2 am/pm 3 am/pm	<b>4</b> 1 5:00 (am/pm) 2 3:00 (am/pm) 3 am/pm
<b>5</b> Water Budget  _____ Applies to all programs	

Station	Description	Run Time	Run Time
1	Front lawn, north side	20 min.	
2	Front lawn, south side	20 min.	
3	Side lawn, north	15 min.	
4	Side lawn, south	15 min.	
5	Front shrub beds		15 min.
6	Rear shrub beds		15 min.
7			
8			
9			

Notes:

P/N 634184



**NOTE:** If the total run time for one program overlaps the start time for a second program, the timer will automatically "stack" the programs and delay the start time of the second program until the first program finishes watering.

6. Next to each station number, enter a brief description of the area covered by each timer station. Remember, a "station" is a set of sprinklers operated by one remote control valve.

This example shows six currently assigned stations, but your ISB 409 can control up to nine stations.

7. In the Run Time column for each program, enter the number of minutes you want each station to run.

Notice that stations 1 through 4 are assigned to program A, while stations 5 and 6 are assigned to program B.

The ISB 409 allows you to use the same station in multiple programs for special watering needs. However, for most applications, choosing not to repeat a station makes programming simpler.



**NOTE:** Any Water Budget setting applies to both programs (A and B).



**PROGRAMMING CHART**  
For ISB Controllers



Program A							Program B								
<input checked="" type="checkbox"/>	<input type="checkbox"/>	<input type="checkbox"/>	<input type="checkbox"/>	<input type="checkbox"/>	<input type="checkbox"/>	<input type="checkbox"/>	<input type="checkbox"/>	<input type="checkbox"/>	<input type="checkbox"/>	<input type="checkbox"/>	<input type="checkbox"/>	<input type="checkbox"/>	<input type="checkbox"/>	<input type="checkbox"/>	<input type="checkbox"/>
<input checked="" type="checkbox"/> 7-day cycle <input type="checkbox"/> even <input type="checkbox"/> odd <input type="checkbox"/> odd, no 31st							<input type="checkbox"/> 3-day cycle <input type="checkbox"/> even <input type="checkbox"/> odd <input type="checkbox"/> odd, no 31st								
1	7:00	am/pm					1	5:00	am/pm						
2		am/pm					2	3:00	am/pm						
3		am/pm					3		am/pm						
Water Budget  _____ Applies to all programs															

6

7

Technical Assistance: 800-247-3782

Water Budget

Station	Description	Run Time	Run Time
1	Front lawn, north side	20 min.	
2	Front lawn, south side	20 min.	
3	Side lawn, north	15 min.	
4	Side lawn, south	15 min.	
5	Front shrub beds		15 min.
6	Rear shrub beds		15 min.
7			
8			
9			

Notes:

P/N 634184

## **PROGRAMMING THE SPRINKLER TIMER**

### **Erase Any Existing Programming**

Use the following procedure any time you want to erase all programming in the timer's memory and "start from scratch."

1. Unplug the transformer from the wall.
2. Disconnect the battery clip from the battery.
3. Wait 10 seconds.
4. Reconnect the battery clip to the battery.
5. Plug the transformer back into the wall.

"AM 12:00" will appear in the display. All previous programming is now erased, and you may turn the Programming Dial to the **DATE/TIME** position and begin setting the Year, Month, Day, and Time.

## Set Year

1. Turn the Programming Dial to the **DATE/TIME** position.
2. The figure "1998" appears in the display window.
3. Press the **Up** or **Down** arrow buttons to set the current year (between 1998 and 2098).
4. Press **Enter**.



**NOTE:** The ISB 409 is year-2000 compliant and will maintain the proper calendar through the year 2098.

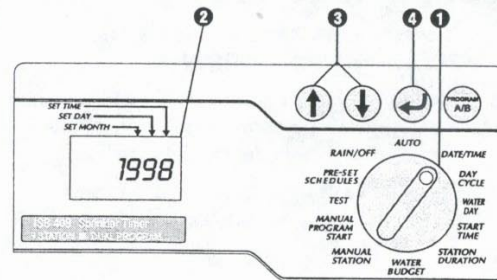

## Set Month and Day

1. After setting the correct year, leave the Programming Dial on **DATE/TIME**.
2. The month and day appear as "01 01," with the first "01" flashing (representing the month). A cursor will appear under the Set Month icon.
3. Press the **Up** or **Down** arrow buttons to set the current month (1 through 12).
4. Press **Enter**.
5. The second "01" begins flashing (representing the day of the month). A cursor will appear under the Set Day icon.
6. Press the **Up** or **Down** arrow buttons to set the current day (1 through 31).
7. Press **Enter**.

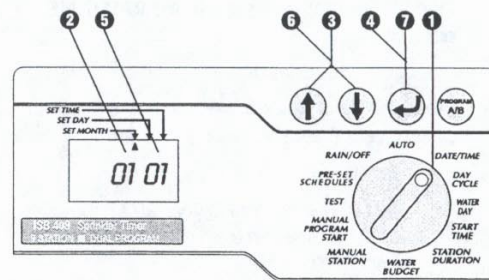



## Set Time

1. After setting the correct month and date, leave the Programming Dial on **DATE/TIME**.
2. The time of day appears in the display. The display will also show AM or PM (for example, 12:01 AM).  
A cursor will appear under the Set Time icon.
3. Press the **Up** or **Down** arrow buttons to set the current hour (1 through 12 AM or PM).
4. Press **Enter**.
5. The minute digits begin flashing.
6. Press the **Up** or **Down** arrow buttons to set the current minute (1 through 59).
7. Press **Enter**.
8. Turn the Programming Dial back to the **AUTO** position.

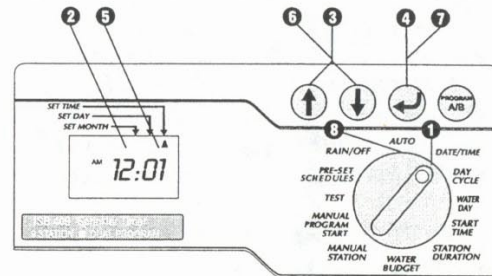

## Select Pre-Set Schedules

Use this procedure if you want to select a pre-set schedule. If you want to set your own custom watering schedule, go directly to Select Program (A or B) on page 19.

For your convenience, the ISB 409 has THREE PRE-SET watering schedules you can select on either program (A or B). These schedules are already programmed into the timer, and are shown below.

- **Pre-set schedule 1 (5 Pr E1)** — Waters all stations for five minutes three times every day at 6 a.m., 10 a.m., and 2 p.m.
- **Pre-set schedule 2 (10 Pr E2)** — Waters all stations for ten minutes every other day at 6 a.m.
- **Pre-set schedule 3 (10 Pr E3)** — Waters all stations for ten minutes every third day at 6 a.m.

1. Turn the Programming Dial to **PRE-SET SCHEDULES**.
2. The first pre-set schedule (5 Pr E1) appears in the display.
3. To select one of the other pre-set schedules, press the **Up** or **Down** arrow buttons until the desired schedule appears in the display.

4. Press the **Program** button until the desired program letter (A or B) appears in the display with the pre-set schedule.
5. Then press **Enter**. The program letter flashes to confirm your selection.

After selecting a pre-set schedule, you can modify the program settings (watering day, start time, etc.) by using the programming steps given on the following pages. If you modify a pre-set schedule, you will not see "Blank" or "Default" settings as described throughout the manual.

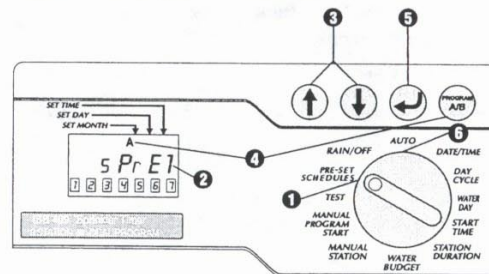

6. Turn the Programming Dial back to the **AUTO** position.

## Select Program (A or B)

1. Turn the Programming Dial to **DAY CYCLE**.
2. The letter of the currently selected program (A or B) appears in the display.
3. Press the **Program** button until the desired program (A or B) appears in the display. Remember, if you plan to use only one program, use program A.



**NOTE:** It is easier to select one program (A or B) and program it completely before moving on to the next program. Switching from program to program can be confusing.

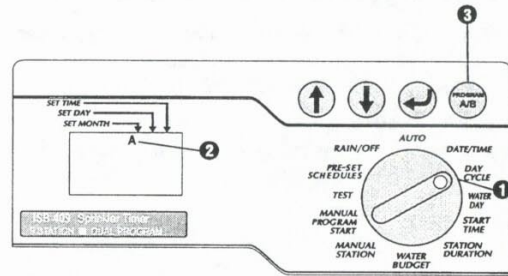

## Set Watering Day Cycle

Use the procedure below if you want to set your own custom watering schedule. Make sure the Programming Dial is on **DAY CYCLE**.



**NOTE:** If you have selected a pre-set schedule (page 18), skip this page. Go directly to "Set Program Start Time(s)" on page 23.

1. Press the **Up** or **Down** arrow buttons until the watering day cycle you want to use appears in the display along with the selected program (A or B). Available watering day cycles include:
  - **7-day** (Custom) — Waters on a weekly cycle; any day of the week can be a watering day.
  - **Ev** — Waters only on even-numbered days.
  - **Od** — Waters only on odd-numbered days.
  - **Od31** — Waters only on odd-numbered days, except the 31st of any month and February 29th. (This watering day cycle complies with special ordinances in some water-restricted areas).
  - **2-, 3-, or 5-day** — Waters only on the first day of a repeating 2-, 3-, or 5-day cycle.

3. If you select a 7-day, or a 2-, 3-, or 5-day watering cycle, go to "Set Watering Days" on page 21.



**NOTE:** If you select **Ev**, **Od**, or **Od31** as your watering day cycle, you do not have to set watering days. Go directly to "Set Program Start Time(s)" on page 23.

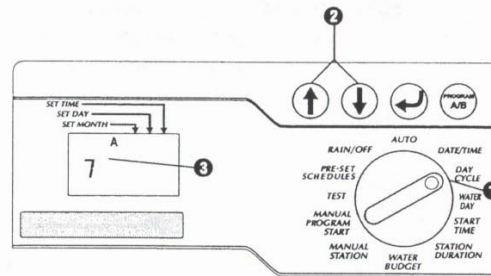

## Set Watering Days

Use the procedure below to set watering days for a 7-day custom watering cycle.

### 7-Day Watering Cycle

1. Turn the Programming Dial to **WATER DAY**.
2. If you selected a 7-day watering cycle, the seven weekdays appear as a row of numbers and the number "1" in the day cycle flashes (day 1 is Monday, day 2 is Tuesday, etc.)
3. The display shows the program's letter (A or B).
4. A number appears, indicating the "today" number (the day on which you are programming the timer). The day's abbreviation also appears in the display.
5. Press the **Up** or **Down** arrow buttons to turn a particular watering day ON or OFF. An ON day has a box around it. An OFF day has no box around it.
6. Press **Enter** to move to the next day.
7. Repeat steps 5 through 7 for each day.

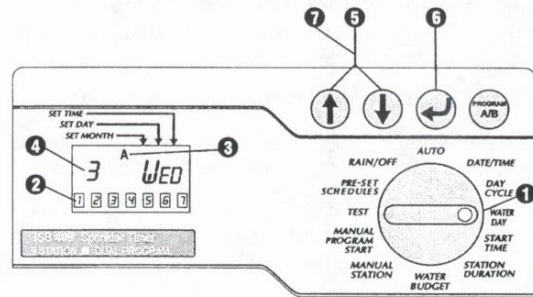

## 2-, 3-, or 5-Day Watering Cycle

Use the procedure below if you selected a 2-, 3-, or 5-day watering cycle.

1. Turn the Programming Dial to **WATER DAY**.
2. If you selected a 2-, 3-, or 5-day watering cycle, the row of days in that cycle appears in the display with a box around day 1.



**NOTE:** The only watering day in a 2-, 3-, or 5-day cycle is day 1.

3. The display shows the program's letter (A or B).
4. A flashing number appears in the display, indicating where "today" is in the watering cycle.
5. Press the **Up** or **Down** arrow buttons to move today's position in the watering cycle.

You may now set program start times as shown on page 23.

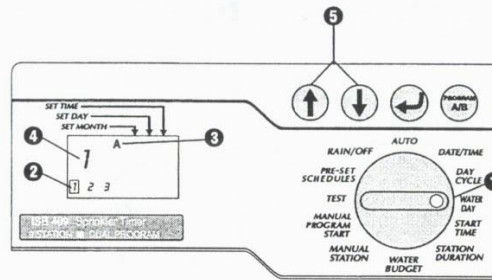

## Set Program Start Time(s)

The start time for your program is the time that the first programmed station begins to run. Each subsequent station will then run in sequence.

1. Turn the Programming Dial to **START TIME**.
2. The program letter (A or B), the number "1" (indicating the earliest start time), and a row of four dashes "--" appear in the display.
3. Press the **Up** or **Down** arrow buttons to set the program start time. A program can begin watering on the hour, quarter-hour, half-hour or three-quarter hour (i.e., 6:00, 6:15, 6:30, 6:45, etc.) If you want all the stations on the program to run only once each watering day, enter only one start time for the program.
4. To enter another start time, press **Enter**. The next start time number (2 or 3) and the row of four dashes appear in the display. Repeat steps 3 and 4 to set up to three separate start times for each program, if needed.



**NOTE:** If you selected one of the pre-set schedules, you will see the default start time(s) for that schedule.

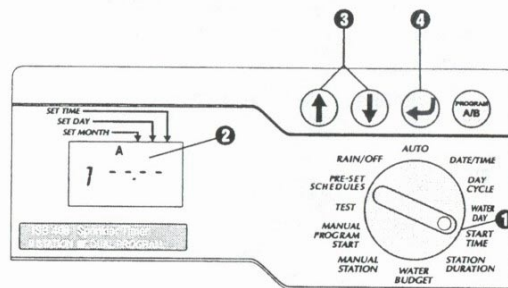

## Delete Program Start Time(s)

1. If you want to delete an unwanted start time from a program, turn the Programming Dial to **START TIME**.
2. Press **Enter** to select the start time number (1, 2, or 3) you want to delete.



**NOTE:** Start times appear in chronological order. The earliest start time is number 1, the next later start time is number 2, and so on. If you delete a start time, all later start times are automatically advanced by one start time number. This re-numbering only occurs after you move the Programming Dial from the **START TIME** position to another function.

3. The start time number to be deleted appears in the display.
4. Press the **Up** or **Down** arrow buttons until the blank position (four dashes, "---") appears in the display. The blank position is located between 11:45 p.m. and 12:00 a.m.
5. Turn the Programming Dial back to the **AUTO** position. The unwanted start time is now deleted.

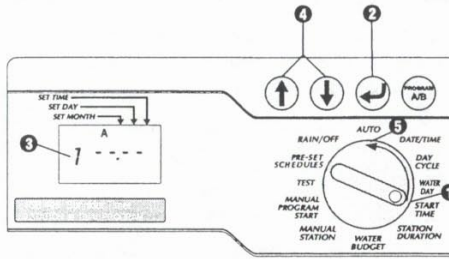



## Set Station Duration Times

1. Turn the Programming Dial to **STATION DURATION**.
2. The program letter (A or B), the number "1" (indicating the station number), and "0 00" appear in the display.
3. Press the **Up** or **Down** arrow buttons to set the run time for station number 1. You can set a station to run from 0 minutes up to 120 minutes (two hours), in one-minute increments. All run times display in minutes (for example, a two hour run time will appear as 120 minutes).



**NOTE:** If you do not want to include a particular station in the selected program, set that station's run time to zero (0 00).

4. Press **Enter** to display additional stations. Repeat steps 3 and 4 to set a run time for each station.

You have now completed all programming steps for one program. If you are finished programming, turn the Programming Dial to the **AUTO** position to run all programs automatically. If you want to enter settings for another program, repeat the programming instructions, beginning with "Select Program (A or B)" on page 19.

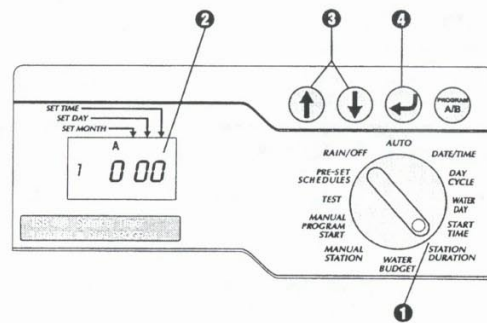

## OPERATING THE SPRINKLER TIMER

After programming the timer, you will normally set it to **AUTO** mode to operate all programs automatically. You can also manually run one or more programs, or manually run a single station or several stations.

In addition, you can adjust the Water Budget feature to increase or decrease the run time of all programs by a selected percentage (in 20% increments). You may also wish to run a test program to make sure all sprinklers in the system operate properly.

### Rain/Off Mode

1. To turn the timer off and suspend all watering, turn the Programming Dial to **RAIN/OFF**.
2. In the RAIN/OFF position, the LCD displays OFF. The timer remembers the current time and date and retains all programming, but no watering occurs. You may wish to turn the timer OFF during a rainy period, or for any day(s) when you do not want watering programs to run as scheduled.

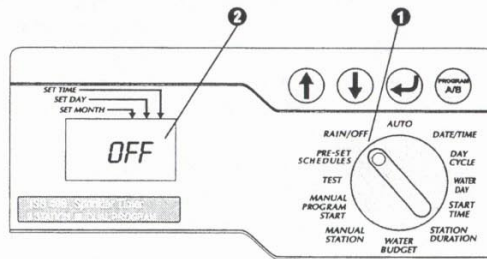

## Auto Mode

- To return the timer to automatic operation, turn the Programming Dial to **AUTO**.
- When the timer IS NOT watering, it displays:
  - Any program (A or B, or none) scheduled to water today
  - The current time
  - %A %B, if there is a Water Budget setting other than 100%

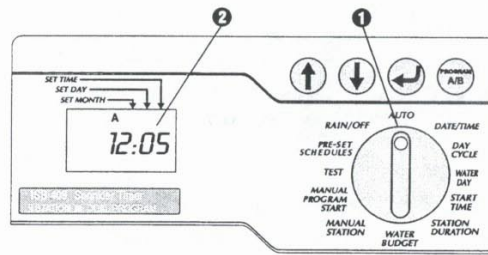

- When the timer IS watering, it displays:
  - The program (A or B) that is running
  - The station number currently running
  - The watering time remaining for that station
  - %A %B, if there is a Water Budget setting other than 100%

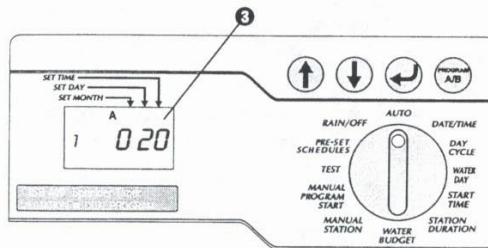

## Adjust Water Budget

Adjusting the Water Budget feature is the easiest way to increase or decrease the run times of all stations on a program. You can use Water Budget to decrease watering during cool winter months, or to increase watering during hot, dry periods.

You can set the Water Budget percentage from 20% to 200% (all station run times doubled), in increments of 20%. Changing the Water Budget percentage affects all stations on both programs (A and B).

Water Budget percentages are calculated on the normal programmed run time for each station. For example, if a station is programmed to run for 10 minutes, and you set the Water Budget to 80%, the station will only run for 8 minutes (80% of 10 minutes). If you set the Water Budget to 120%, that same station will run for 12 minutes (120% of 10 minutes).



**NOTES:** Water Budget will not split a minute. One whole minute is the lowest run time allowed.

All run times for every programmed station will be increased or decreased when you use the Water Budget feature.

1. Turn the Programming Dial to **WATER BUDGET**.

2. The number "100" appears in the display. This indicates that all stations are running at 100% of their programmed watering time.
3. Press the **Up** arrow button to increase the Water Budget percentage, or press the **Down** arrow to decrease the Water Budget percentage.

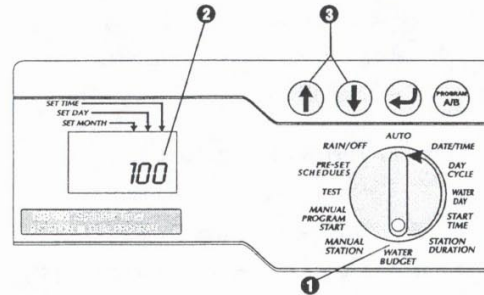

4. When the Water Budget percentage is set to any figure other than 100, both programs (A and B) display a percent sign (%) in front of the program letter. The percent sign appears on both programs (A and B) even if they are not selected.
5. After setting the desired Water Budget percentage, turn the Programming Dial back to **AUTO**. All station run times will be increased or decreased by the selected Water Budget percentage.

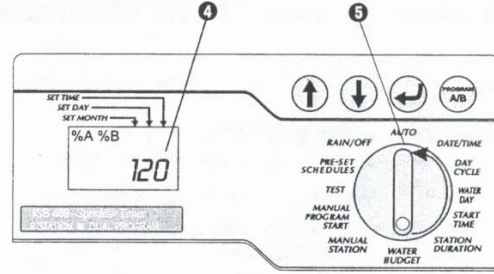

## Manually Run Stations and Programs

You can run individual stations or an entire program if you think a particular area needs additional watering.

### Manually Run a Station(s)

1. Turn the Programming Dial to **MANUAL STATION**.
2. The number "1" followed by "0 00" appears in the display. This means that station number 1 is set for zero manual run time.
3. If you want to manually run a station other than number 1, press **Enter** until the desired station number appears in the display.
4. If you want to manually run the displayed station, press the **Up** or **Down** arrow buttons to set the station's manual run time (from one minute to 120 minutes).
5. Press **Enter** to begin watering.



**NOTE:** You can "stack" higher numbered stations to operate manually by pressing **Enter** after setting the run time for each station. Stacked stations will run in consecutive order, even if they are stacked in a different order (i.e., a lower numbered station will not run if it is stacked after a higher numbered station).

6. After setting the manual run time for all stations desired, turn the Programming Dial back to **AUTO**. The number of the first manually operated station appears in the display, along with its remaining run time. You can press **Enter** to manually advance to the next station.

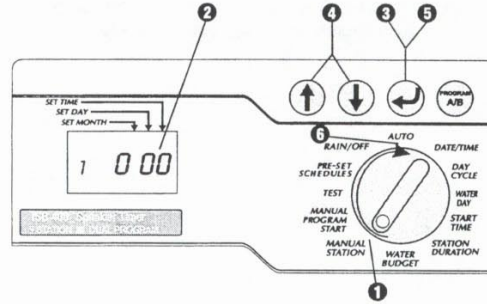

When manual operation finishes, the timer returns to **AUTO** mode and awaits the next scheduled program start time.

## Manually Run a Program

1. Turn the Programming Dial to **MANUAL PROGRAM START**.
2. Program "A" appears in the display.
3. To choose another program, press the **Program** button until the desired program letter appears in the display.
4. Press **Enter** to start the selected program.



**NOTES:** You can "stack" both programs (A and B) to operate manually by pressing **Enter** after selecting each program. Program A will run first, followed by Program B.

5. Turn the Programming Dial back to **AUTO**. The letter of the manually operating program (A or B) appears in the display. Any "stacked" program letter flashes until its turn to run.



**NOTE:** Water budgeting does not apply to manually operated programs.

After the last manual program runs, the timer returns to **AUTO** mode and awaits the next scheduled program start time.

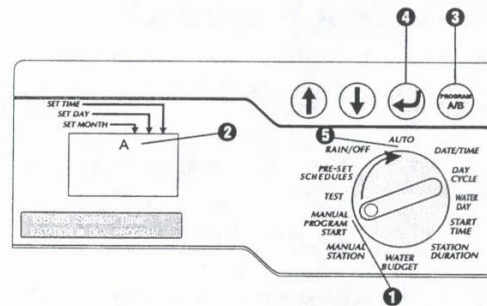

**NOTES:** Manually operating a station does not affect the station's run time(s) in the automatic programs (A or B).

Manual operation cancels the operation of any automatic program in progress. Also, Water Budgeting does not affect manually operated stations.

## Run a Test Program

The ISB 409's built-in test program will run each station that has a non-zero watering time. When you run the test program, the timer operates each station in numerical sequence, from lowest to highest. You can use this feature to check the operation of all sprinklers in the system.

1. To test all timer stations, turn the Programming Dial to **TEST**.



**NOTE:** If you want to test only one (or more) stations, follow the procedure in "Manually Run a Station(s)" on page 30.

2. The number "2" appears in the display, representing a two-minute test run per station.



**NOTE:** The default two-minute test run time cannot be set higher or lower.

3. Press **Enter** to start the all-stations test.
4. Then turn the Programming Dial back to the **AUTO** position.

During the test, the number of each operating station appears in the display, along with the station's remaining run time. Any station set for a zero run time in the automatic programs (A or B) will be skipped in the all-stations test.



**NOTE:** At any time during the all-stations test, you can press **Enter** to manually advance to the next station.

When the all-stations test is complete, the timer returns to **AUTO** mode and awaits the next scheduled program start time.

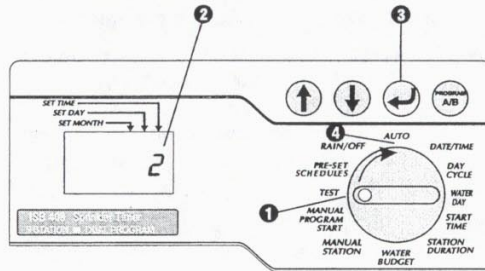



## INSTALLING THE SPRINKLER TIMER

Although this manual provides directions for connecting the wiring to the timer, local electrical codes may vary in their requirements for proper and safe installation.



**NOTES:** This timer must be installed in full compliance with local electrical codes.

The ISB 409 sprinkler timer must be installed indoors only.

---

### Choose a Proper Location

Choose a secure location where you can easily reach the timer. We recommend mounting the timer at eye level in a utility room (garage, laundry room, etc.)

1. The mounting location must be within 5 feet (1,5m) of an electrical wall outlet.



**NOTE:** To minimize electrical interference, select a location at least 15 feet (4,6 m) away from high-draw motors such as air conditioners, refrigerators, or pool pumps.

2. When selecting a location, choose a flat, stable vertical surface on which to mount the timer. Make sure to allow enough clearance for electrical conduit and connections at the bottom of the timer case.

## Mount the Sprinkler Timer

1. Hold the template provided against the wall in the desired mounting location. Use a pencil to mark the location of the three holes for the mounting fasteners, as shown on the template.
2. Use a nail to tap a small pilot hole on each pencil mark for the mounting fasteners. Using the mounting fasteners provided, drive the top two fasteners into the wall.
3. Use the keyhole-shaped slots on the back of the timer to hang the timer on the two mounting fasteners. Make sure the shafts of the fasteners are well up into the narrow part of the keyhole slot.
4. Remove the lower access cover and drive the third mounting fastener through the hole in the timer's lower access panel.

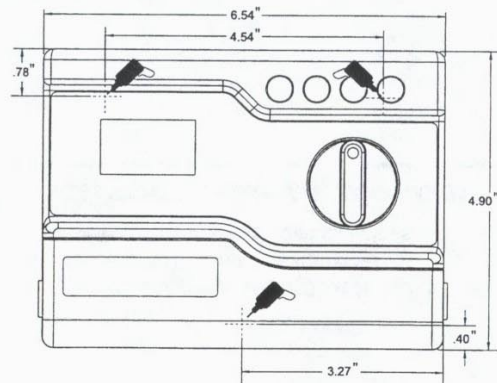

## Connect Main Power Wires

The ISB 409 sprinkler timer has an external transformer that reduces standard supply voltage to 24 VAC to operate the remote valves connected to the timer.



**CAUTION:** To avoid electrical shock, DO NOT plug in the transformer until you have connected it to the timer.

To connect the transformer cable to the terminal strip in the timer cabinet:

1. Make sure the transformer is NOT plugged in.
2. Plug the snap-on connector on the transformer cable into the "24VAC" connection point on the timer terminal strip.
3. Plug the transformer into any standard, three-prong 117 VAC grounded wall plug.

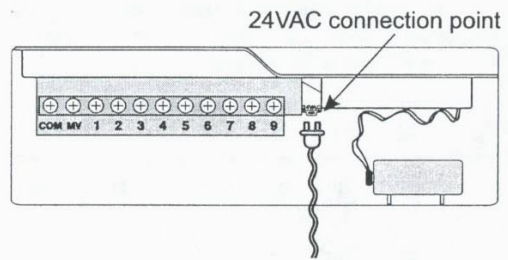

---

## Connect Field Wires to Remote Control Valves

The wires coming back to the timer from the electric valves in the field can be routed into the timer through the hole in the bottom of the cabinet.

This illustration shows the various wire runs and connections between the timer and the other devices. Each valve should have its own, separate power wire. Use only wire that is code-approved for underground, low-voltage purposes.

1. Connect one end of the power wire to a numbered station terminal on the timer's terminal strip. Connect the other end of the power wire to one of the wire leads on the valve solenoid. The wire connectors at the valves must be waterproof.
2. Connect the valve common wire to the "COM" terminal on the terminal strip. Route the common wire out to the furthest valve, and connect the valve common wire to the remaining wire lead on each valve.
3. If your system includes a master valve on its main line supply, or a 24-volt pump start relay (for activating a pump during irrigation), connect a wire from the device to the "MV" terminal on the timer's terminal strip. (The timer does not provide the main power for a pump.) Connect the other wire lead on the device to the valve common wire.
4. That completes the mounting and wiring procedures for your ISB 409 sprinkler timer. Replace the lower access cover on the timer, and you are ready to begin programming. Refer to "Programming the Sprinkler Timer" on page 14.

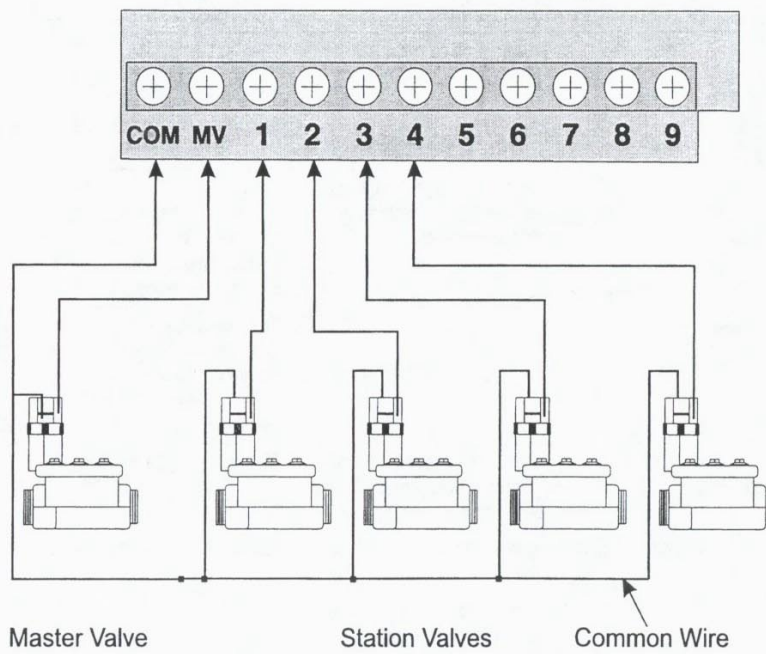

## TROUBLESHOOTING

SYMPTOM	POSSIBLE CAUSE	CORRECTION
LCD display is blank.	1. Power is off to the timer.	Re-establish power to the timer. If the current time is not shown, or your program is no longer in memory, reprogram the timer.
	2. If under battery power, the timer may be in "sleep" mode.	Press any button to reactivate the timer.
LCD display is partially or completely blank.	3. An electrical surge or lightning strike may have affected the timer's electronics.	Turn off the timer and disconnect the 9-Volt battery. Let the timer sit for two or three minutes. Then reconnect the battery and restore power to the timer. Reset the time and date as described on page 17.  If the electrical surge did no permanent damage, the timer will accept programming commands and function normally. If the timer does not operate properly, contact Rain Bird Technical Assistance at 800-247-3782.
	4. The valve may have a defective diaphragm, a clogged pilot port, or other malfunction.	Check and repair the valve.
Program does not begin watering as scheduled.	5. Programming Dial is set to the RAIN/OFF position.	Set the Programming Dial to AUTO.
	6. Start time has not been properly entered for the program.	Turn the dial to START TIME and check the start times entered for the program. If the start time is missing or incorrect, enter it as described on page 23.

<b>SYMPTOM</b>	<b>POSSIBLE CAUSE</b>	<b>CORRECTION</b>
A particular station does not come on as scheduled.	7. Today may not be set as a watering day for the program.	If today is a watering day for a program, the program letter appears in the display. Turn the dial to WATER DAY to check the watering days for the program. If necessary, set watering days as described on page 21.
	8. Water supply may be shut off.	Make sure water supply line has pressure.
	9. No run time has been set for the station.	Turn the Programming Dial to STATION DURATION to check the run times set for the station. To add a run time, see page 25.
	10. A short circuit in the solenoid or valve wiring has disabled the station.	Identify and repair the fault in the electrical circuit.
Watering starts when it should not.	11. A start time has not been entered for the station's assigned program.	Turn the dial to START TIME and check the start times entered for the program. If the station's start time is missing, enter it as described on page 23.
	12. One of the pre-set schedules may be selected.	Make sure that no program letter (A or B) appears in the display with any of the pre-set schedules. See page 18.
	13. An unwanted program start time may have been entered.	Turn the dial to START TIME and check to see if any programs have an unwanted start time. See the instructions beginning on page 23 for setting and deleting start times.

<b>SYMPTOM</b>	<b>POSSIBLE CAUSE</b>	<b>CORRECTION</b>
Watering does not stop as scheduled.	14. Programs may have accidentally been set to overlap.	Check to see if another program's start time began during the previous program's run cycle. The overlapped program would immediately follow the earlier one. Reprogram if necessary.
	15. A valve is stuck in the open position.	Turn the Programming Dial to RAIN/OFF and wait 10-20 seconds. If the irrigation does not stop, shut off the valve manually and repair the valve.



**Notes:**

This sprinkler timer generates radio frequency energy and may cause interference to radio and television reception. It has been type tested and found to comply with the limits for a Class B computing device in accordance with the specifications in Subpart J of Part 15 of FCC Rules, which are designed to provide reasonable protection against such interference in a residential installation. However, there is no guarantee that interference will not occur in a particular installation.

If this equipment does cause interference to radio or television reception, which can be determined by turning the equipment off and on, the user is encouraged to try to correct the interference by one or more of the following measures:

1. Reorient the receiving antenna.

2. Move the timer away from the receiver.
3. Plug the timer into a different outlet so that the timer and receiver are on different branch circuits.

If necessary, the user should consult the dealer or an experienced radio / television technician for additional suggestions. The user may find the following booklet prepared by the Federal Communications Commission helpful:

"How to Identify and Resolve Radio-TV Interference Problems."

This booklet is available from the U.S. Government Printing Office, Washington, D.C. 20402, Stock No. 004-000-00345-4.