

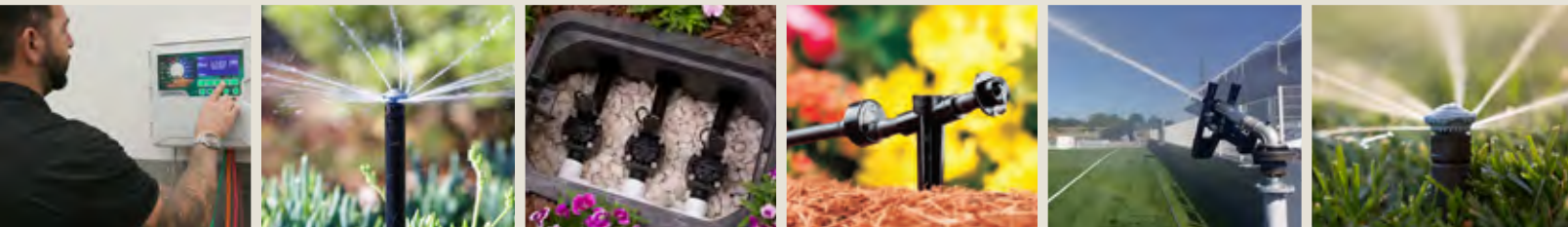

Landscape Irrigation Products 2021 Catalog



The Intelligent Use of Water.™

**Preserving beauty while
conserving water.**

That's intelligent.

The Intelligent Use of Water™

At Rain Bird, we believe it is our responsibility to develop products and technologies that use water efficiently. Our commitment also extends to education, training and services for our industry and our communities.

Through innovative product development, Rain Bird is helping sustain healthier landscapes—and a healthier planet. A lush lawn or colorful garden can also be highly water-efficient. Every Rain Bird product is a testament to that truth.

From water-saving nozzles to sprays with pressure-regulating stems to leading-edge Smart Control Technology, Rain Bird products make the most of every drop, delivering superior results with less water. Keeping the world and your backyard beautiful. That's The Intelligent Use of Water.™

The need to conserve water has never been greater. We want to do even more, and with your help, we can.



Water efficient irrigation technology for every landscape application

When you design and install Rain Bird complete irrigation solutions, you can be confident knowing that the system will perform better and last longer for many years to come. No matter what your irrigation needs are, Rain Bird has a solution that will help save water for every application in your next green project.



Spray Bodies
Page



Central Controls
Page 103



Spray & Rotary Nozzles
Page 14



Drip Irrigation
Page 113

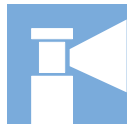

Rotors
Page 37



Pump Stations & Filtration
Page 168



Valves
Page 60



Drainage Products
Page 182



Controllers
Page 81



Resources
Page 193



Sensors & Meters
Page 96



Together, we can make a difference

At Rain Bird, we believe that saving water is a responsibility that we all share. Our industry can have a tremendous impact on water conservation by installing more efficient systems and teaching customers how to use them correctly. By working together, we can really make a difference.

Rain Bird's 25 Ways offers practical, effective tips and advice drawn from the company's 80-plus years of experience in the irrigation industry. Available at 25ways.rainbird.com, these resources can be used anywhere and by anyone who wants to improve their watering efficiency.

Water Saving Tips from Rain Bird

Visit 25ways.rainbird.com for a complete list of water saving tips and techniques in each of the following categories.



Improve Your Existing System



Water Only At The Right Times



Don't Overwater



Use The Right Products

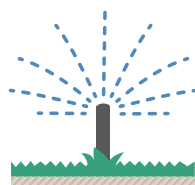

Keep Your Water In Place



Update Your Landscape



Spray Bodies

Major Products														
	1802, 1804, 1806	1812	1800 PRS	1800 SAM	1800 SAM-PRS	1800 SAM- PRS-45	US-400	1300/ 1400 Bubblers	PA-80 PA-85 PA-85-NP PA-85-PRS PA-85-P45	RD-04, RD-06	RD-12	RD1800 SAM- PRS	RD1800 SAM- PRS-F	RD1800 SAM- PRS-45-F
Primary Applications														
Turfgrass	●		●	●	●	●	●			●		●	●	●
Slopes				●	●	●	●					●	●	●
Ground Cover/Shrubs	●	●	●	●	●	●	●	●	●	●	●	●	●	●
High Pressure Systems			●		●	●		●	●	●	●	●	●	●
Low Pressure Systems	●	●					●	●	●	●	●			
High Wind Areas	●	●	●	●	●	●	●	●	●	●	●	●	●	●
Non-Potable Water									●	●	●	●	●	●
Vandalism/Damage Prone													●	●
Dirty Water										●	●	●	●	●

Water Saving Water Saving Tips

- The patented, built-in PRS regulator maintains optimal operating pressure and restricts water loss by up to 70% if a nozzle is removed or damaged. It also ends water waste by eliminating misting and fogging caused by high pressure.
- Save water, stop low head drainage, and reduce water hammer by preventing water from draining out of pipes after irrigation with 1800/RD1800 Series Sprays featuring Seal-A-Matic™ (SAM) check valves.
- Exclusive Flow Shield Technology available in the RD1800 Series provides up to 90% reduction in water loss when a nozzle is removed, preventing potentially costly and unacceptable run-off.

- Introduction
- Spray Bodies
- Spray & Rotary Nozzles
- Rotors
- Valves
- Controllers
- Sensors & Meters
- Central Controls
- Drip Irrigation
- Pumps & Filtration
- Drainage Products
- Resources

UNI-Spray™ Series

Compact and reliable spray heads for any application

Features

- Small exposed cover makes the unit virtually invisible for more attractive landscapes
- Constructed of durable materials including corrosion resistant stainless steel, assuring long product life even in high pressure or surge conditions
- Pressure-activated wiper seal prevents excessive flow-by and water waste and keeps debris from entering upon retraction
- Two-piece ratchet mechanism allows easy nozzle pattern alignment and provides added durability
- Three Year Trade Warranty

Operating Range (for pre-installed nozzle choices)

- Spacing:
 - 8' HE-VAN Series: 6 to 8 feet (1.8 to 2.4m)
 - 10' HE-VAN Series: 8 to 10 feet (2.4 to 3.0m)
 - 12' HE-VAN Series: 9 to 12 feet (2.7 to 3.7m)
 - 15' HE-VAN Series: 12 to 15 feet (3.7 to 4.6m)
- Pressure: 15 to 70 psi (1.0 to 4.8 bar)
- Optimum pressure: 30 psi (2.1 bar)
- Adjustable nozzle arc range: 0° - 360°

Specifications

- Flow-by: 0 at 10 psi (0.75 bar) or greater; 0.20 gpm (0.04 m³/h; 0.60 l/m) otherwise

Models*

- US400: 4" pop-up height (10.2cm)

Models with High-Efficiency Nozzles Pre-Attached*

- US408HE: 4" pop-up height (10.2cm) with HE-VAN-08 attached
- US410HE: 4" pop-up height (10.2cm) with HE-VAN-10 attached
- US412HE: 4" pop-up height (10.2cm) with HE-VAN-12 attached
- US415HE: 4" pop-up height (10.2cm) with HE-VAN-15 attached

*The UNI-Spray accepts all Rain Bird nozzles



High Efficiency Variable Arc Nozzles (8, 10, 12, or 15 feet) are available pre-installed



UNI-Spray™

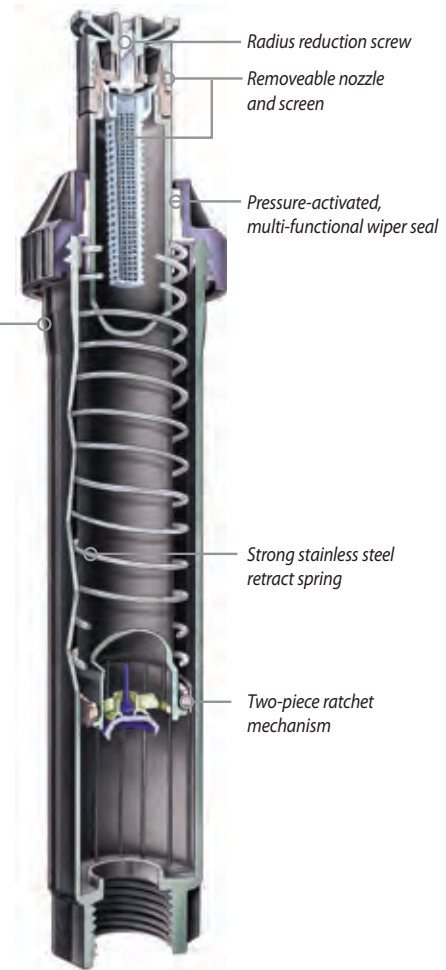

How to Specify

US - 4 - 10HE

Nozzle Series/Pattern
HE-VAN nozzle

Body
4" (10.2 cm)

Model
UNI-Spray

1800® Series

The #1 irrigation spray head in the world

Features

- Co-molded wiper seal provides unmatched resistance to grit, pressure and the environment
- Constructed of time-proven UV-resistant plastic and corrosion resistant stainless steel parts, ensuring long product life
- Precision controlled flush at pop-down clears debris from unit, assuring positive stem retraction in all soil types
- Two-piece ratchet mechanism allows easy nozzle pattern alignment and provides added durability
- Five Year Trade Warranty

Operating Range

- Spacing: 2.5 to 24 feet (0.8 to 7.3m)**
- Pressure: 15 to 70 psi (1.0 to 4.8 bar)

Specifications

- Flow-by: 0 gpm at 8 psi (0.6 bar) or greater;
0.10 gpm (0.02 m³/h; 0.36 l/m) otherwise

Dimensions/Models

- ½" NPT female threaded inlet
- Models and height:
 - 1802: 4" (10.2 cm) body height; 2" pop-up height (5.1 cm)
 - 1804: 6" (15.2 cm) body height; 4" pop-up height (10.2 cm)
 - 1806: 9 ⅜" (23.8 cm) body height; 6" pop-up height (15.2 cm)
 - 1812: 16" (40.6 cm) body height; 12" pop-up height (30.5 cm)
- Exposed surface diameter: 2 ¼" (5.7 cm)

* 1806 and 1812-SAM, SAMPRS, and SAM-PRS-45 units do not have a side inlet

** 2.5 to 15 feet with standard Rain Bird Spray Head Nozzles (SQ, U-Series, HE-VAN) 8 to 24 feet with Rain Bird Rotary Nozzles (R-VAN)

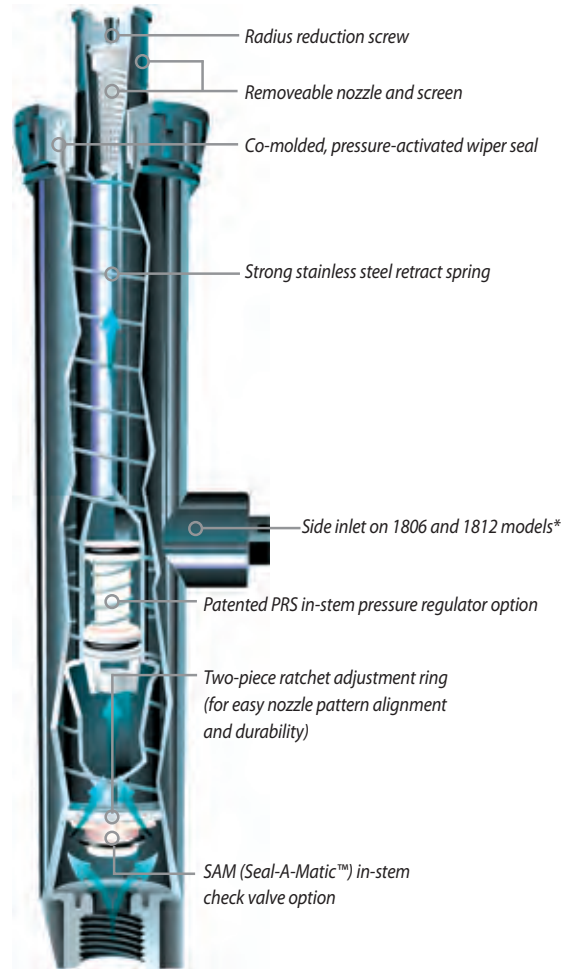

1800 Series

How to Specify

1804 SAM-PRS

Option
SAM: Seal-A-Matic™ check valve
PRS: Pressure regulator (30psi)
P45: Pressure regulator (45psi)

Pop-up Height
1802: 2" pop-up height (5.1 cm)
1804: 4" pop-up height (10.2 cm)
1806: 6" pop-up height (15.2 cm)
1812: 12" pop-up height (30.5 cm)

Model
1800 Series Spray Bodies

1800®-SAM, 1800®-PRS, 1800®-P45, 1800®-SAM-PRS, 1800®-SAM-P45 Series

4", 6", 12" (10.2 cm, 15.2 cm, 30.5 cm)

Features

- **1800®-SAM Series:** Built-in Seal-A-Matic™ (SAM) check valve. Eliminates the need for under-the-head check valves. Traps water in lateral pipes in elevation changes of up to 14 feet (4.2 m). Reduces wear on system components by minimizing water hammer during start-up
- **1800®-PRS Series:** Maintains constant outlet pressure at 30 psi (2.1 bar). PRS pressure regulator built into the stem simplifies system design. Eliminates misting and fogging caused by high pressure. Saves time and money
- **1800®-P45 Series:** Maintains constant outlet pressure at 45 psi (3.1 bar). P45 pressure regulator built into the stem simplifies system design. Eliminates misting and fogging caused by high pressure. Saves time and money
- **1800®-SAM-PRS Series:** Incorporates all 1800 Series SAM and PRS features. Meets the needs of all spray areas, regardless of changing elevation or water pressures
- **1800®-SAM-P45 Series:** Incorporates all 1800 Series SAM and P45 features. Maintains constant outlet pressure at 45 psi (3.1 bar) at varying inlet pressures. Ensures maximum spray body and nozzle performance, even with varying inlet pressures. Maintains constant pressure regardless of nozzle used

Specifications

- 4", 6", 12" (10.2 cm, 15.2 cm, 30.5 cm)
- SAM capability: holds up to 14 feet (4.2 m) of head; 6 psi (0.4 bar)
- PRS and P45 models regulate nozzle pressure to an average 30 or 45 psi (2.1 or 3.1 bar) with inlet pressures of up to 70 psi (4.8 bar)
- Flow-by: 0 gpm at 8 psi (0.6 bar) or greater; 0.10 gpm (0.02 m³/h; 0.36 l/m) otherwise
- Installation: side or bottom inlet
- Side inlet installation not recommended in freezing climates
- Five Year Trade Warranty

1800®-SAM Models

- 1804-SAM: 4" pop-up height (10.2 cm)
- 1806-SAM: 6" pop-up height (15.2 cm)
- 1812-SAM: 12" pop-up height (30.5 cm)

1800®-PRS Models

- 1804 PRS: 4" pop-up height (10.2 cm)
- 1806 PRS: 6" pop-up height (15.2 cm)
- 1812 PRS: 12" pop-up height (30.5 cm)

1800®-P45 Models

- 1804 P45: 4" pop-up height (10.2 cm)
- 1806 P45: 6" pop-up height (15.2 cm)
- 1812 P45: 12" pop-up height (30.5 cm)

1800®-SAM-PRS Models

- 1804-SAM-PRS: 4" pop-up height (10.2 cm)
- 1806-SAM-PRS: 6" pop-up height (15.2 cm)
- 1812-SAM-PRS: 12" pop-up height (30.5 cm)

1800®-SAM-P45 Models

- 1804-SAM-P45: 4" pop-up height (10.2 cm)
- 1806-SAM-P45: 6" pop-up height (15.2 cm)
- 1812-SAM-P45: 12" pop-up height (30.5 cm)

Operating Range

- Spacing: 2.5 to 24 feet (0.8 to 7.3m)*
- Pressure: 15 to 70 psi (1.0 to 4.8 bar)



1800-SAM



1800-PRS



1800-PRS-45



1800-SAM-PRS



1800-SAM-P45



When using 30psi and 45psi
pressure regulating
spray heads

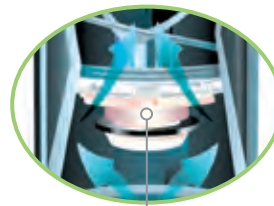

Built in Seal-A-Matic check valve prevents low-head drainage, ideal for use in changing elevations

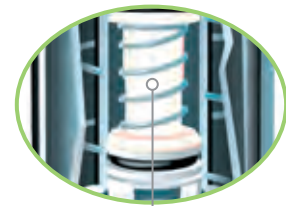

Patented pressure regulator in stem compensates for high or fluctuating water pressure to ensure maximum performance

* 2.5 to 18 feet with standard Rain Bird Spray Head Nozzles (SQ, MPR, VAN, HE-VAN, U-Series), 8 to 24 feet with Rain Bird Rotary Nozzles (R-VAN)

RD1800™ Series Spray Heads

Robust Design for Harsh Applications

Features

- Patented, Triple-Blade Wiper Seal precisely balances flushing, flow-by and debris protection to optimize performance and durability at pop-up and retraction. Precision-controlled flushing at pop-up and retraction clears debris, ensuring positive stem retraction in all soil types
- Unique debris pockets hold grit in place, removing it from circulation and preventing long-term damage. Parts resistant to corrosion in treated recycled water containing chlorine
- RD1800™ SAM PRS Series:** Incorporates all RD1800 Series SAM and PRS features. Meets the needs of all spray areas, regardless of changing elevation or water pressures
- RD1800™ SAM P45 Series:** Incorporates all RD1800 Series SAM and P45 features. Ensures maximum spray body and nozzle performance even with varying inlet pressures. Recommended for use with rotary nozzles (R-VAN)
- RD1800™ Flow-Shield™ Series:** Provides low flow vertical water jet visible from +200' line of sight when a nozzle has been removed
- RD1800™ Non-Potable Water Series:** Provides an alternative to clip-on caps and molded purple covers. Easy-to-read English "DO NOT DRINK", Spanish "NO BEBA" warnings, and international do not drink symbol

Operating Range

- Spacing: 2.5 to 24 feet (0.8 to 7.3 m)
- Pressure: 15 to 100 psi (1.0 to 6.9 bar)

Specifications

- 4", 6", 12" (10.2 cm; 15.2 cm; 30.5 cm)
- SAM capability: Holds up to 14 feet (4.2 m) of head; 6 psi (0.3 bar)
- Flow-by: SAM Models: 0 at 15 psi (1.0 bar) or greater; 0.5 gpm (0.1 m³/h; 0.03 l/s) otherwise
All Other Models: 0 at 10 psi (0.7 bar) or greater; 0.5 gpm (0.1 m³/h; 0.03 l/s) otherwise
- SAM-PRS models regulate nozzle pressure to an average 30 psi (2.1 bar) with inlet pressures of up to 100psi (6.9 bar)
- SAM-P45 models regulate nozzle pressure to an average 45 psi (3.1 bar) with inlet pressures of up to 100 psi (6.9 bar)
- Five-year trade warranty

Dimensions

- ½" NPT female threaded inlet

Models

	4"	6"	12"
RD04	–	–	–
RD04-NP	–	–	–
RD04-S-P-30-NP	RD06-S-P-30-NP	RD12-S-P-30-NP	
RD04-S-P-30-F	RD06-S-P30-F	RD12-S-P-30-F	
RD04-S-P-30-F-NP	RD06-S-P-30-F-NP	RD12-S-P-30-F-NP	
RD04-S-P-45-NP	RD06-S-P-45-NP	RD12-S-P-45-NP	
RD04-S-P-45-F	RD06-S-P-45-F	RD12-S-P-45-F	
RD04-S-P-45-F-NP	RD06-S-P-45-F-NP	RD12-S-P-45-F-NP	



RD1800 Series



When using 30psi and 45psi pressure regulating spray heads



Standard Cover



Non-Potable Cover

How to Specify

RD-XX - X - Nozzle

Nozzle
See R-VAN, U-Series, MPR, VAN, HE-VAN and SQ Nozzle specifications for more information

Optional Features

S: Seal-A-Matic™ check valve
P30: 30 psi (2.1 bar) in-stem pressure regulation
P45: 45 psi (3.1 bar) in-stem pressure regulation
F: Flow-Shield™ Technology
NP: Non-potable water use indicating cover

Model

RD-04: 4" (10 cm) pop-up height
RD-06: 6" (15 cm) pop-up height
RD-12: 12" (30.5 cm) pop-up height

Notes:

Specify sprinkler bodies and nozzles separately.

1800® NP Cover

Non-Potable 1800 Spray Head Cover

Features

- Designed for excellent retention on 1800 Series Spray Body covers
- Purple plastic cover for easy identification of non-potable water system
- Marked with "Do Not Drink!" warning in both English and Spanish
- Snaps onto all 1800® Series Spray Body covers

Model

- 1800-NP



1800-NP

PA

Plastic Shrub Adapter

Features

- Adapts Rain Bird Nozzles for use with ½" (15/21) NPT threaded risers
- Accepts protective, non-clogging 1800 Series filter screen (shipped with nozzle) and PCS Series screens
- Durable, non-corrosive plastic construction
- Non-Potable Plastic Shrub Adapter

Specifications

- ½" (15/21) female inlet threads
- Fine top threads accept all Rain Bird nozzles

Model

- PA-8S
- PA-8S-NP



PA-8S PA-8S-NP

PA-80

Plastic Adapter

Features

- Adapts Rain Bird Spray Bodies for use with any ½" (15/21) FPT bubbler or spray nozzle
- Rugged, UV-resistant thermoplastic construction
- Easy to install; no tools required

Dimensions

- Height: 1½" (3.8 cm); 0.8" (2.0 cm) above 1800 cap

Model

- PA-80



PA-80

1800®-EXT

Plastic Extension

Features

- UV-resistant thermoplastic construction for long life
- Fits all Rain Bird Spray Bodies and Nozzles. Exception: Cannot be used with bubblers

Model

- 1800-EXT



1800-EXT

PA-8S-PRS & PA-8S-P45

30 psi and 45 psi Pressure Regulating Shrub Adapters

Features

- Adapts nozzles for use with ½" (15/21) NPT threaded risers
- Patented PRS pressure regulator built into the stem. No parts to be installed at the site. Saves time and money
 - Maintains constant pressure at 30 psi (2,1 bar) or 45 psi (3,1 bar)
 - Restricts water loss by up to 70% if nozzle is removed or damaged. Saves water and money. Reduces liability. Recommended for vandal-prone areas
- Fits all Rain Bird plastic nozzles
- Rugged thermoplastic construction resists UV rays

Operating Range

- Pressure: 15 to 70 psi (1.0 to 4.8 bar)
- Flow: 0.2 to 4.0 gpm (0.05 to 0.91 m³/h; 0.06 to 15.0 l/m)

Specifications

- ½" female inlet threads
- Fine top threads accept all Rain Bird nozzles
- Height: 5¼" (13.3 cm)

Models

- PA-8S-PRS
- PA-8S-P45



PA-8S-PRS & PA-8S-P45

1800 PCS

Pressure Compensating Screens

Features

- Compensates* for pressure variations
- Eliminates fogging and water waste caused by high pressures
- Nozzles can be matched with screens to create short-throw, reduced-radius patterns and/or flush-mounted bubblers
- Color-coded for easy identification
- Use with all 1800 Series plastic nozzles (MPR, VAN, U-Series, HE-VAN, Strips and Bubblers)

Operating Range

- Flow: 0.20 to 0.90 gpm (0.05 to 0.20 m³/h; 0.6 to 3.6 l/m)
- Pressure: 15 to 70 psi (1.0 to 4.8 bar)

Models

- PCS-020: 0.2 gpm (0.05 m³/h; 0.6 l/m) - Brown
- PCS-025: 0.25 gpm (0.06 m³/h; 1.2 l/m) - Pink
- PCS-030: 0.3 gpm (0.07 m³/h; 1.2 l/m) - Silver
- PCS-040: 0.4 gpm (0.09 m³/h; 1.8 l/m) - Orange
- PCS-060: 0.6 gpm (0.14 m³/h; 2.4 l/m) - Black



1800 PCS Screens

* With a pressure compensator, outlet pressure will be reduced, but will fluctuate as the inlet pressure changes. A pressure compensator cannot maintain outlet pressure at a constant rate. A pressure regulator establishes and maintains a constant outlet pressure of 30 psi (2.1 bar) or 45 psi (3.1 bar) as long as the inlet pressure at the spray head is greater than 30psi (2.1 bar) or 45 psi (3.1 bar)

1800 PCS Performance

Flow (gpm) m ³ /h (l/m)	PCS-020 (Brown) 0.2 0.05 (60)		PCS-025 (Pink) 0.25 0.06 (72)		PCS-030 (Silver) 0.3 0.07 (84)		PCS-040 (Orange) 0.4 0.09 (108)		PCS-060 (Black) 0.6 0.14 (144)	
	feet	meters	feet	meters	feet	meters	feet	meters	feet	meters
Distance										
U-Series										
U-8Q	6	(1.8)	7	(2.1)						
U-8H	4	(1.2)	5	(1.5)						
U-8F					1	(0.3)	3	(0.9)	7	(2.1)
U-10Q	5	(1.5)	6	(1.8)	10'	(3.1)				
U-10H					5	(1.5)	6	(1.8)	8	(2.4)
U-10F									4	(1.2)
U-12Q					7'	(2.1)	12'	(3.7)		
U-12H	2'	(0.6)	4	(1.2)	3'	(0.9)	4'	(1.2)	7'	(2.1)
U-12F							3'	(0.9)	6'	(1.8)
U-15Q					6'	(1.8)	11'	(3.4)	15'	(4.6)
U-15H			3'	(0.9)	2'	(0.6)	3'	(0.9)	5'	(1.5)
U-15F									4'	(1.2)
VAN										
4 (90°)	1'	(0.3)			3'	(0.9)	4'	(1.2)		
4 (180°)			1'	(0.3)	2'	(0.6)	3'	(0.9)	4'	(1.2)
4 (270°)					1'	(0.3)	2'	(0.6)	4'	(1.2)
4 (330°)					1'	(0.3)	2'	(0.6)	4'	(1.2)
6 (90°)			2'	(0.6)	3'	(0.9)	6'	(1.8)		
6 (180°)					2'	(0.6)	4'	(1.2)	6'	(1.8)
6 (270°)					0.5'	(0.2)	1'	(0.3)	3'	(0.9)
6 (330°)					0.5'	(0.2)	1'	(0.3)	3'	(0.9)
8 (90°)					1'	(0.3)	3'	(0.9)	8'	(2.4)
8 (180°)					0.5'	(0.2)	2'	(0.6)	4'	(1.2)
8 (270°)							0.5'	(0.2)	3'	(0.9)
8 (330°)							0.5'	(0.2)	3'	(0.9)
10 (90°)					3'	(0.9)	5'	(1.5)	10'	(3.1)
10 (180°)							1'	(0.3)	5'	(1.5)
10 (270°)							1'	(0.3)	4'	(1.2)
10 (360°)					0.5'	(0.2)	1'	(0.3)	4'	(1.2)
12 (90°)	3'	(0.9)			8'	(2.4)	10'	(3.1)	12'	(3.7)
12 (180°)					1'	(0.3)	2'	(0.6)	5'	(1.5)
12 (270°)					0.5'	(0.2)	1'	(0.3)	3'	(0.9)
12 (360°)							1'	(0.3)	3'	(0.9)
15 (90°)					2'	(0.6)	5'	(1.5)	11'	(3.4)
15 (180°)					1'	(0.3)	3'	(0.9)	6'	(1.8)
15 (270°)										
15 (360°)										
18 (90°)					0.5'	(0.2)	2'	(0.6)	6'	(1.8)
18 (180°)							1'	(0.3)	3'	(0.9)
18 (270°)							0.5'	(0.2)	1'	(0.3)
18 (330°)							0.5'	(0.2)	1'	(0.3)
MPR										
5Q										
5T										
5H	5'	(1.5)	6'	(1.8)						
5F					5'	(1.5)				
8Q	8'	(2.4)	10'	(3.1)						
8T	6'	(1.8)	6.5'	(2.0)	7'	(2.1)	8'	(2.4)		
8H	5'	(1.5)	6'	(1.8)	7'	(2.1)	8'	(2.4)		
8F					2'	(0.6)	3'	(0.9)	8'	(2.4)
10Q	6'	(1.8)	8'	(2.4)	8'	(2.4)	10'	(3.1)		
10T	4'	(1.2)	5'	(1.5)	9'	(2.7)	10'	(3.1)		
10H	3'	(0.9)	4'	(1.2)	6'	(1.8)	8'	(2.4)	10'	(3.1)
10F							1'	(0.3)	4'	(1.2)
12Q	3'	(0.9)	7'	(2.1)	8'	(2.4)	11'	(3.4)	12'	(3.7)
12T	2'	(0.6)	4'	(1.2)	6'	(1.8)	10'	(3.1)	11'	(3.4)
12H					4'	(1.2)	6'	(1.8)	10'	(3.1)
12TT					2'	(0.6)	4'	(1.2)	6'	(1.8)
12TQ					2'	(0.6)	3'	(0.9)	6'	(1.8)
12F							2'	(0.6)	5'	(1.5)
15Q	3'	(0.9)	4'	(1.2)	5'	(1.5)	9'	(2.7)	12'	(3.7)
15T			2'	(0.6)	5'	(1.5)	7'	(2.1)	12'	(3.7)
15H					3'	(0.9)	4'	(1.2)	7'	(2.1)
15TT					1'	(0.3)	2'	(0.6)	4'	(1.2)
15TQ										
15F										
Bubbler										
5Q-B	2'	(0.6)	3	(0.9)	4'	(1.2)	5'	(1.5)		
5H-B					1'	(0.3)	2'	(0.6)	5'	(1.5)
5F-B							1'	(0.3)	2'	(0.6)
5CST-B	1'	(0.3)	2	(0.6)	3'	(0.9)	5'	(1.5)		
9SST										
15CST							4' x 12'	(1.2 x 3.7)	4' x 24'	(1.2 x 7.3)
15SST							2' x 10'	(0.6 x 3.1)	3' x 20'	(0.9 x 6.1)
15EST							4' x 15'	(1.2 x 4.6)		
15LCS	1' x 5'	(0.3 x 1.5)	1' x 7'	(0.3 x 2.1)	1' x 12'	(0.3 x 3.7)				
15RCS	1' x 5'	(0.3 x 1.5)	1' x 7'	(0.3 x 2.1)	1' x 12'	(0.3 x 3.7)				

Bold green type indicates recommended nozzle/screen combination to achieve catalog performance at 30 psi (2.1 bar)

Bold blue type indicates satisfactory nozzle/screen combination

Black type indicates a nozzle/screen combination that provides a throw reduction of more than 50%. With these nozzle/screen combinations a uniform spray pattern is not assured and a bubbler effect may result.

Note: Screens were tested at 50 psi (3.5 bar) for 10 minutes prior to taking distance measurements. Distances may vary slightly with higher pressures and longer run-times

Note: Refer to catalog notation for proper nozzle selection

SA Series

Swing Assemblies Connect Heads to Lateral Pipes.

Features

- Quality alternative to locally assembled swing pipe/spiral barb fittings that do not carry a manufacturer's warranty
- Comprehensive range of products support a variety of landscape solutions
- Complementary engineered fittings and spray heads instill confidence in product specification

Specifications

- The operating range of the Rain Bird Swing Assemblies matches or exceeds the operating range for most 1/2" (1.3 cm) sprays and 3/4" (1.9 cm) rotors
- Operating pressure: Up to 80 psi (5.5 bar)
- Surge pressure: Up to 240 psi (15.5 bar)
- Temperature: Up to 110° F (43° C)
- Maximum flow: 8 gpm (0.5 l/sec)



Swing Pipe Flexible
Sprinkler Assembly



SA Series

How to Specify

SA 12 5050

Inlet/Outlet
050: 1/2" x 1/2"
5050: 1/2" x 1/2"
7575: 3/4" x 3/4"

Length
18"
12"
6"

Model
Swing Assembly

SA Series Swing Assemblies Specifications

Model Number	Length		Inlet		Outlet	
	US	METRIC	US	METRIC	US	METRIC
SA-6050	6"	15.2 cm	1/2"	1.3 cm	1/2"	1.3 cm
SA-125050	12"	30.5 cm	1/2"	1.3 cm	1/2"	1.3 cm

SPX Series Swing Pipe

Swing Pipe with Spiral Barb Fittings Provides a Flexible Swing Assembly for Sprays and Rotors

Features and Benefits

- **SPX-FLEX100**
 - Superior flexibility allows pipe to be efficiently routed around hardscape, terraces, and uneven terrain to turn landscape design into reality
 - Textured surface makes product easier to handle, contributing to labor efficiency, especially under wet conditions
 - Resists kinking
 - Quick and easy installation lowers material and labor costs
 - Installs quickly leaving time for additional system installations and incremental revenue opportunities

Specifications

- Inside diameter: 0.49" (1.24 cm)
- Operating pressure: Up to 80 psi (5.5 bar)
- Temperature: Up to 110° F (43° C)

Models

- SPX-FLEX-100: 100' (30 m) coil

SPX-FLEX

Extra Flexible Kink-Resistant Swing Pipe



- Same High Quality
- NOW 25% More Flexible



SPX-FLEX100

SB Series Spiral Barb Fittings

A Natural Product Complement to SPX Series Swing Pipe

Features and Benefits

- Fittings are made of robust acetal material to make connecting swing pipe fast and easy
- Easy twist-in insertion – no glue or clamps needed for installation
- Aggressive barb lip makes a secure connection that is less likely to leak

- Broad range of shapes and sizes allow the contractor to choose the best fitting for the application
- Extended length and aggressive barb lip prevent blow outs, reducing likelihood of contractor call backs

Specifications

- Operating pressure: Up to 80 psi (5.5 bar)
- Temperature: Up to 110° F (43° C)

Models

- SB-CPLG: 1/2" barb x 1/2" barb coupling
- SBA-050: 1/2" M NPT x 1/2" barb adapter
- SBE-075: 3/4" M NPT x 1/2" barb elbow
- SBE-050: 1/2" M NPT x 1/2" barb elbow
- SB-TEE: 1/2" barb x 1/2" barb x 1/2" barb tee

SB-CPLG

SBA-050

SBE-075



SBE-050

SB-TEE



Spray & Rotary Nozzles

Major Products

	Rotary Nozzles	Variable ARC Sprays		Fixed ARC Sprays	
Primary Applications	R-VAN Best	HE-VAN Best	VAN Standard	U-Series Best	MPR Standard
Turfgrass	●	●	●	●	●
Slopes	●				
Narrow Strips	●				●
Trees					
Landscape Beds	●	●	●	●	●
High Efficiency	●	●		●	
High Winds	●	●			
High Pressure	●				

Refer to page 124 for more information on SQ Series, Square Pattern Nozzles



Water Saving Tips

- Rotary Nozzles have efficient water distribution through rotating streams that uniformly deliver water at a low precipitation rate, significantly reducing runoff and erosion.
- HE-VAN nozzles are fully adjustable from 0 to 360 degrees with high uniformity and efficiency. HE-VAN nozzles can reduce the number of variations that need to be carried to cover just about any field challenge. Available in radii from 8' to 15', this high efficient nozzle has you covered.
- U-Series Nozzles are dual-orifice nozzles that have better, more uniform water distribution. Water flowing from both orifices combines to form a continuous water stream and eliminates gaps for more uniform coverage throughout the entire watering area.

- Introduction
- Spray Bodies
- Spray & Rotary Nozzles
- Rotors
- Valves
- Controllers
- Sensors & Meters
- Central Controls
- Drip Irrigation
- Pumps & Filtration
- Drainage Products
- Resources



What is a High-Efficiency Nozzle?

Typical nozzles – Un-Even Watering

With typical nozzles, part of the lawn may not have enough water and other parts may be over-watered. A large portion of water may be lost to evaporation / misting, and over-spray.

High-efficiency nozzles – Even Watering

High-efficiency nozzles provide better coverage. Better coverage means shorter zone run-times while keeping grass healthy. Shorter run-times means you will save up to 25%+ water vs. typical nozzles. Rain Bird's high-efficiency nozzles are also engineered to produce large water droplets to reduce wind drift.











Standard or Low Precipitation Rate?

Low Precipitation Rate Nozzles

Low precipitation rate nozzles are best used in sloped or compacted soil areas to minimize run-off. The low watering rate makes run-times longer.

Standard Precipitation Rate Nozzles

Standard precipitation rate nozzles are best used for shorter distance irrigation, and when watering times may be limited due to city ordinances.

Low Precipitation Rate		Standard Precipitation Rate				
High-Efficiency Rotary Nozzles		High-Efficiency Nozzles		Standard Nozzles		
						
 <p>R-VAN</p>		 <p>HE-VAN</p>	 <p>U-Series</p>	 <p>VAN</p>	 <p>MPR</p>	
Adjustable Arc (45° - 270°)	Full Circle (360°)	Adjustable Arc	Fixed Arc	Adjustable Arc	Fixed Arc	

R-VAN Nozzles

High Efficiency, Multi-Stream

Rain Bird® R-VAN Adjustable Rotary Nozzles save more water, are easier to use, and are lower priced compared to leading rotating nozzles. R-VANs thick streams and large water droplets cut through the wind to deliver water where you want it. R-VANs are easier to use thanks to its hand-adjustable arc and radius.

Features

- Matched precipitation across radius, arcs, and pattern types
- Low precipitation rate reduces run-off and erosion
- Adjust arc and radius without tools
- A pull-up to flush feature clears the nozzle of dirt and debris
- Maintains efficient performance at high operating pressures without misting or fogging
- Compatible with all models of Rain Bird spray bodies, risers and adapters
- Installing with Rain Bird 5000 MPR Series Rotors allows for matched precipitation from 8' to 35' (2.4m to 10.7m)
- Three year trade warranty

Operating Specifications

- Pressure Range: 30 to 55 psi (2.1 to 3.8 bar)
- Recommended Operating Pressure: 45 psi (3.1 bar)
- Spacing: 8' to 24' (2.4 to 7.3m)
- Adjustments: Arc and radius should be adjusted while water is running

Models

8' - 14' (2.4 to 4.6m)

- R-VAN14: 45° - 270° Adjustable Arc
- R-VAN14-360: 360° Full Circle

13' - 18' (4.0 to 5.5m)

- R-VAN18: 45° - 270° Adjustable Arc
- R-VAN18-360: 360° Full Circle

17' - 24' (5.2 to 7.3m)

- R-VAN24: 45° - 270° Adjustable Arc
- R-VAN24-360: 360° Full Circle

Strip Nozzles

- R-VAN-LCS: 5' x 15' (1.5 x 4.6m) Left Corner Strip
- R-VAN-RCS: 5' x 15' (1.5 x 4.6m) Right Corner Strip
- R-VAN-SST: 5' x 30' (1.5 x 9.1m) Side Strip

¹ Rain Bird recommends using 1800 P45 Spray Bodies to maintain optimum nozzle performance



R-VAN Nozzles

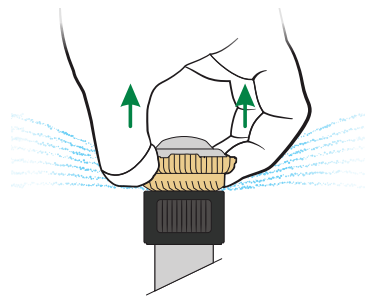

Pull Up **HARD**
to Flush

For Optimum Performance, Use
Rain Bird 1800 45 PSI Regulated or
RD1800 45 PSI Regulated Spray Bodies



How to Specify

R-VAN 18-360

Radius Range

8' - 14' (2.4 to 4.6m)

R-VAN14: 45° - 270°

R-VAN14-360: 360°

13' - 18' (4.0 to 5.5m)

R-VAN18: 45° - 270°

R-VAN18-360: 360°

17' - 24' (5.2 to 7.3m)

R-VAN24: 45° - 270°

R-VAN24-360: 360°

Strip Nozzles

R-VAN-LCS: 5' x 15' (1.5 x 4.6m)

R-VAN-RCS: 5' x 15' (1.5 x 4.6m)

R-VAN-SST: 5' x 30' (1.5 x 9.1m)

Model

R-VAN Adjustable Rotary Nozzle



R-VAN Nozzles meet the requirements of the ASABE/ICC 802-2014 standard





The average DU(LQ) of the applicable products exceed 0.65 distribution uniformity.

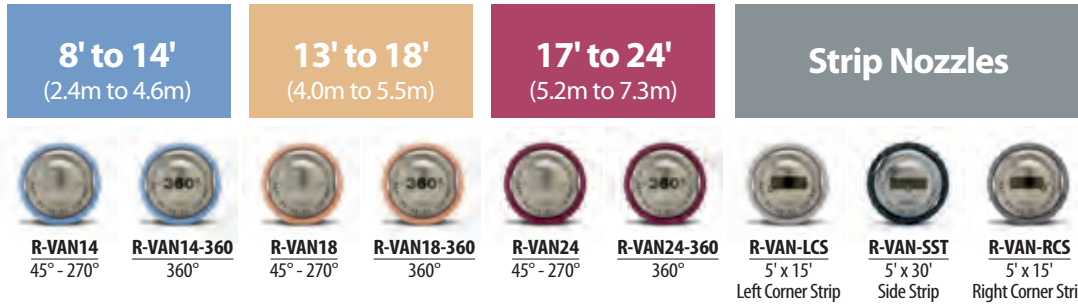



Product	Type	Radius	DU(LQ)
R-VAN	Multi-stream	8 - 24 ft.	> 0.70

To view the complete document of compliance for Rain Bird products that have been tested to meet the requirements of the ASABE/ICC 802-2014 standard and the California MWELO go to: www.rainbird.com/agency/mweo





8' - 14' Adjustable Arc Nozzles (45° to 270°)

R-VAN14 8' - 14'					
Nozzle	Pressure psi	Radius ft.	Flow gpm	■ Precip In/h	▲ Precip In/h
270° 	30	13	0.84	0.64	0.76
	35	13	0.87	0.66	0.74
	40	14	0.92	0.60	0.71
	45	14	0.94	0.62	0.70
	50	15	1.11	0.63	0.73
210° 	30	13	0.65	0.64	0.76
	35	13	0.68	0.66	0.74
	40	14	0.72	0.60	0.71
	45	14	0.73	0.62	0.70
	50	15	0.86	0.63	0.73
180° 	30	13	0.56	0.64	0.76
	35	13	0.58	0.66	0.74
	40	14	0.61	0.60	0.71
	45	14	0.63	0.62	0.70
	50	15	0.74	0.63	0.73
90° 	30	13	0.28	0.64	0.76
	35	13	0.29	0.66	0.74
	40	14	0.31	0.62	0.71
	45	14	0.32	0.61	0.70
	50	15	0.37	0.63	0.73
55	15	0.39	0.67	0.77	

R-VAN14 2.4 to 4.6m						METRIC
Nozzle	Pressure bar	Radius m	Flow l/m	■ Precip mm/h	▲ Precip mm/h	
270° 	2.1	4.0	3.18	16	19	
	2.4	4.0	3.29	17	19	
	2.8	4.3	3.48	15	18	
	3.1	4.3	3.56	16	18	
	3.4	4.6	4.20	16	19	
210° 	2.1	4.0	2.46	16	19	
	2.4	4.0	2.57	17	19	
	2.8	4.3	2.73	15	18	
	3.1	4.3	2.76	16	18	
	3.4	4.6	3.26	16	19	
180° 	2.1	4.0	2.12	16	19	
	2.4	4.0	2.20	17	19	
	2.8	4.3	2.31	15	18	
	3.1	4.3	2.38	16	18	
	3.4	4.6	2.80	16	19	
90° 	2.1	4.0	1.06	16	19	
	2.4	4.0	1.10	17	19	
	2.8	4.3	1.17	16	18	
	3.1	4.3	1.21	15	18	
	3.4	4.6	1.40	16	19	
3.8	4.6	1.48	17	20		

8' - 14' Full Circle Nozzles (360°)

R-VAN14-360 8' - 14'					
Nozzle	Pressure psi	Radius ft.	Flow gpm	■ Precip In/h	▲ Precip In/h
360° 	30	13	1.10	0.63	0.72
	35	13	1.12	0.64	0.74
	40	14	1.22	0.60	0.69
	45	14	1.27	0.62	0.72
	50	15	1.41	0.60	0.70
55	15	1.45	0.62	0.72	





R-VAN14-360 2.4 to 4.6m						METRIC
Nozzle	Pressure bar	Radius m	Flow l/m	■ Precip mm/h	▲ Precip mm/h	
360° 	2.1	4.0	4.16	16	18	
	2.4	4.0	4.24	16	19	
	2.8	4.3	4.62	15	18	
	3.1	4.3	4.81	16	18	
	3.4	4.6	5.34	15	18	
3.8	4.6	5.49	16	18		





Note: All R-VAN nozzles tested on 4" (10.2 cm) pop-ups
 ■ Square spacing based on 50% diameter of throw
 ▲ Triangular spacing based on 50% diameter of throw

Performance data taken in zero wind conditions
 R-VAN24 and R-VAN24-360: "Do not reduce the radius below 17' (5.2 m)
 R-VAN18 and R-VAN18-360: "Do not reduce the radius below 13' (4.0 m)
 R-VAN14 and R-VAN14-360: "Do not reduce the radius below 8' (2.4 m)

13' - 18' Adjustable Arc Nozzles (45° to 270°)

Spray & Rotary Nozzles

R-VAN18 13' - 18'					
Nozzle	Pressure psi	Radius ft.	Flow gpm	■ Precip In/h	▲ Precip In/h
270° 	30	16	1.26	0.65	0.75
	35	16	1.35	0.64	0.74
	40	17	1.42	0.63	0.73
	45	17	1.51	0.64	0.73
	50	18	1.57	0.60	0.69
210° 	30	16	0.98	0.63	0.73
	35	16	1.05	0.68	0.78
	40	17	1.10	0.63	0.73
	45	17	1.17	0.64	0.77
	50	18	1.22	0.62	0.72
180° 	30	16	0.85	0.65	0.75
	35	16	0.91	0.64	0.74
	40	17	0.98	0.63	0.73
	45	17	1.01	0.64	0.73
	50	18	1.07	0.60	0.69
90° 	30	16	0.42	0.65	0.75
	35	16	0.47	0.64	0.74
	40	17	0.50	0.63	0.73
	45	17	0.50	0.64	0.73
	50	18	0.54	0.60	0.69
55	18	0.58	0.60	0.69	

R-VAN18 4.0 to 5.5m						METRIC
Nozzle	Pressure bar	Radius m	Flow l/m	■ Precip mm/h	▲ Precip mm/h	
270° 	2.1	4.9	4.77	17	19	
	2.4	4.9	5.11	16	19	
	2.8	5.2	5.38	16	19	
	3.1	5.2	5.72	16	19	
	3.4	5.5	5.94	15	18	
210° 	2.1	4.9	3.71	16	19	
	2.4	4.9	3.97	17	20	
	2.8	5.2	4.16	16	19	
	3.1	5.2	4.43	16	20	
	3.4	5.5	4.62	16	18	
180° 	2.1	4.9	3.22	17	19	
	2.4	4.9	3.44	16	19	
	2.8	5.2	3.71	16	19	
	3.1	5.2	3.82	16	19	
	3.4	5.5	4.05	15	18	
90° 	2.1	4.9	1.59	17	19	
	2.4	4.9	1.78	16	19	
	2.8	5.2	1.89	16	19	
	3.1	5.2	1.89	16	19	
	3.4	5.5	2.04	15	18	
3.8	5.5	2.20	15	18		

13' - 18' Full Circle Nozzles (360°)

R-VAN18-360 13' - 18'					
Nozzle	Pressure psi	Radius ft.	Flow gpm	■ Precip In/h	▲ Precip In/h
360° 	30	16	1.65	0.62	0.72
	35	16	1.67	0.63	0.73
	40	17	1.80	0.60	0.69
	45	17	1.85	0.62	0.71
	50	18	2.05	0.61	0.70
55	18	2.11	0.63	0.72	

R-VAN18-360 4.0 to 5.5m						METRIC
Nozzle	Pressure bar	Radius m	Flow l/m	■ Precip mm/h	▲ Precip mm/h	
360° 	2.1	4.9	6.25	16	18	
	2.4	4.9	6.32	16	19	
	2.8	5.2	6.81	15	18	
	3.1	5.2	7.00	16	18	
	3.4	5.5	7.76	15	18	
3.8	5.5	7.99	16	18		

Note: All R-VAN nozzles tested on 4" (10.2 cm) pop-ups
 ■ Square spacing based on 50% diameter of throw
 ▲ Triangular spacing based on 50% diameter of throw

Performance data taken in zero wind conditions
 R-VAN24 and R-VAN24-360: "Do not reduce the radius below 17" (5.2 m)
 R-VAN18 and R-VAN18-360: "Do not reduce the radius below 13" (4.0 m)
 R-VAN14 and R-VAN14-360: "Do not reduce the radius below 8" (2.4 m)





Did you know?





You can use R-VAN Nozzles and 5000 Series MPR Rotors on the same zone!

- Matched precipitation rate (MPR) from 8' to 35'
- Superior coverage – >0.70 DU[LQ]
- Thick, wind-resistant streams – near to far





17' - 24' Adjustable Arc Nozzles (45° to 270°)

R-VAN24		17' - 24'				
Nozzle	Pressure psi	Radius ft.	Flow gpm	■ Precip In/h	▲ Precip In/h	
270° 	30	19	1.80	0.64	0.74	
	35	20	1.95	0.63	0.72	
	40	22	2.31	0.61	0.71	
	45	23	2.52	0.61	0.71	
	50	24	2.82	0.63	0.73	
55	24	2.88	0.64	0.74		
210° 	30	19	1.40	0.64	0.74	
	35	20	1.52	0.63	0.72	
	40	22	1.80	0.61	0.71	
	45	23	1.96	0.61	0.71	
	50	24	2.19	0.63	0.73	
55	24	2.24	0.64	0.74		
180° 	30	19	1.20	0.64	0.74	
	35	20	1.30	0.63	0.72	
	40	22	1.54	0.61	0.71	
	45	23	1.68	0.61	0.71	
	50	24	1.88	0.63	0.73	
55	24	1.92	0.64	0.74		
90° 	30	19	0.60	0.64	0.74	
	35	20	0.65	0.63	0.72	
	40	22	0.77	0.61	0.71	
	45	23	0.84	0.61	0.71	
	50	24	0.94	0.63	0.73	
55	24	0.96	0.64	0.74		

R-VAN24		5.2 to 7.3m				METRIC
Nozzle	Pressure bar	Radius m	Flow l/m	■ Precip mm/h	▲ Precip mm/h	
270° 	2.1	5.8	6.81	16	19	
	2.4	6.1	7.38	16	18	
	2.8	6.7	8.74	15	18	
	3.1	7.0	9.54	15	18	
	3.4	7.3	10.67	16	19	
3.8	7.3	10.90	16	19		
210° 	2.1	5.8	5.30	16	19	
	2.4	6.1	5.75	16	18	
	2.8	6.7	6.81	15	18	
	3.1	7.0	7.42	15	18	
	3.4	7.3	8.29	16	19	
3.8	7.3	8.48	16	19		
180° 	2.1	5.8	4.54	16	19	
	2.4	6.1	4.92	16	18	
	2.8	6.7	5.83	15	18	
	3.1	7.0	6.36	15	18	
	3.4	7.3	7.12	16	19	
3.8	7.3	7.27	16	19		
90° 	2.1	5.8	2.27	16	19	
	2.4	6.1	2.46	16	18	
	2.8	6.7	2.91	15	18	
	3.1	7.0	3.18	15	18	
	3.4	7.3	3.56	16	19	
3.8	7.3	3.63	16	19		

17' - 24' Full Circle Nozzles (360°)

R-VAN24-360		17' - 24'				
Nozzle	Pressure psi	Radius ft.	Flow gpm	■ Precip In/h	▲ Precip In/h	
360° 	30	19	2.35	0.63	0.72	
	35	20	2.52	0.61	0.70	
	40	22	3.13	0.62	0.72	
	45	23	3.48	0.63	0.73	
	50	24	3.61	0.60	0.70	
	55	24	3.74	0.62	0.72	

R-VAN24-360		5.2 to 7.3m				METRIC
Nozzle	Pressure bar	Radius m	Flow l/m	■ Precip mm/h	▲ Precip mm/h	
360° 	2.1	5.8	8.90	16	18	
	2.4	6.1	9.54	15	18	
	2.8	6.7	11.85	16	18	
	3.1	7.0	13.17	16	19	
	3.4	7.3	13.67	15	18	
	3.8	7.3	14.16	16	18	

Note: All R-VAN nozzles tested on 4" (10.2 cm) pop-ups

■ Square spacing based on 50% diameter of throw

▲ Triangular spacing based on 50% diameter of throw

Performance data taken in zero wind conditions

R-VAN24 and R-VAN24-360: "Do not reduce the radius below 17' (5,2 m)

R-VAN18 and R-VAN18-360: "Do not reduce the radius below 13' (4,0 m)

R-VAN14 and R-VAN14-360: "Do not reduce the radius below 8' (2,4 m)

R-VAN Requires Half the Models to Cover 45° to 360°



Offering Valuable Bottom-Line Savings

- Shorter zone run times save water and energy
- Lower precipitation rates reduce wasteful runoff and costly erosion
- Fewer nozzles needed to cover any area, reducing your inventory costs

Strip Nozzles (Left Corner, Side, Right Corner)

R-VAN-LCS 5' x 15'					
Nozzle	Pressure psi	Size ft.	Flow gpm	Precip In/h	Precip In/h
Left Corner Strip	30	4'x14'	0.18	0.62	0.62
	35	5'x15'	0.22	0.56	0.56
	40	5'x15'	0.23	0.59	0.59
	45	5'x15'	0.24	0.62	0.62
	50	5'x15'	0.25	0.64	0.64
	55	6'x16'	0.28	0.56	0.56

R-VAN-LCS 1.5 x 4.6m METRIC					
Nozzle	Pressure bar	Size m	Flow l/m	Precip mm/h	Precip mm/h
Left Corner Strip	2.1	1.2x4.3	0.68	16	16
	2.4	1.5x4.6	0.83	14	14
	2.8	1.5x4.6	0.87	15	15
	3.1	1.5x4.6	0.91	16	16
	3.4	1.5x4.6	0.95	16	16
	3.8	1.8x4.9	1.06	14	14

R-VAN-SST 5' x 30'					
Nozzle	Pressure psi	Size ft.	Flow gpm	Precip In/h	Precip In/h
Side Strip	30	4'x28'	0.36	0.62	0.62
	35	5'x30'	0.44	0.56	0.56
	40	5'x30'	0.46	0.59	0.59
	45	5'x30'	0.48	0.62	0.62
	50	5'x30'	0.50	0.64	0.64
	55	6'x32'	0.56	0.56	0.56

R-VAN-SST 1.5 x 9.1m METRIC					
Nozzle	Pressure bar	Size m	Flow l/m	Precip mm/h	Precip mm/h
Side Strip	2.1	1.2x8.5	1.36	16	16
	2.4	1.5x9.1	1.67	14	14
	2.8	1.5x9.1	1.74	15	15
	3.1	1.5x9.1	1.82	16	16
	3.4	1.5x9.1	1.89	16	16
	3.8	1.8x9.8	2.12	14	14

R-VAN-RCS 5' x 15'					
Nozzle	Pressure psi	Size ft.	Flow gpm	Precip In/h	Precip In/h
Right Corner Strip	30	4'x14'	0.18	0.62	0.62
	35	5'x15'	0.22	0.56	0.56
	40	5'x15'	0.23	0.59	0.59
	45	5'x15'	0.24	0.62	0.62
	50	5'x15'	0.25	0.64	0.64
	55	6'x16'	0.28	0.56	0.56

R-VAN-RCS 1.5 x 4.6m METRIC					
Nozzle	Pressure bar	Size m	Flow l/m	Precip mm/h	Precip mm/h
Right Corner Strip	2.1	1.2x4.3	0.68	16	16
	2.4	1.5x4.6	0.83	14	14
	2.8	1.5x4.6	0.87	15	15
	3.1	1.5x4.6	0.91	16	16
	3.4	1.5x4.6	0.95	16	16
	3.8	1.8x4.9	1.06	14	14

Note: All R-VAN nozzles tested on 4" (10.2 cm) pop-ups
Performance data taken in zero wind conditions

— Straight-line spacing based on 50% overlap of throw for LCS, SST, and RCS
▲ Triangular spacing based on 50% overlap of throw for LCS, SST, and RCS

Easy Adjustments

Adjustable Arc Nozzles

R-VAN14, R-VAN18, R-VAN24

RADIUS ADJUSTMENT

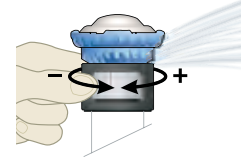

ARC ADJUSTMENT

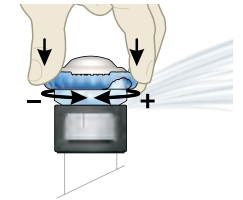

Full Circle Nozzles

R-VAN14-360, R-VAN18-360, RVAN24-360

RADIUS ADJUSTMENT

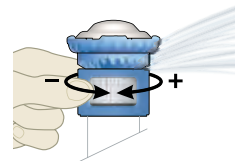

Strip Nozzles

R-VAN-LCS, R-VAN-RCS, R-VAN-SST

SIZE ADJUSTMENT

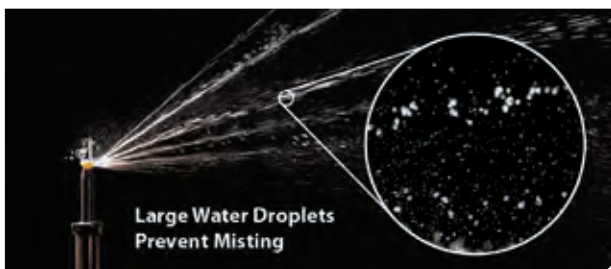
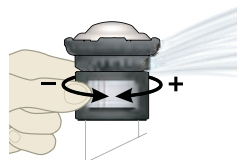

Improving Watering Efficiencies Up to 30%

- Gentle, rotating streams create uniform coverage at lower precipitation rates
- Multi-stream technology optimizes absorption for healthier lawns
- Larger droplets and thicker streams cut through wind and keep water in target zone

HE-VAN Series Nozzles

High-Efficiency Variable Arc Spray Nozzles

Features

- HE-VAN's even coverage allows you to shorten run times by up to 35%, saving you water and money, while still maintaining a healthy lawn. HE-VAN has more than a 40 percent even-coverage improvement over existing variable arc nozzles
- HE-VAN nozzles have a unique stream pattern, designed for superior coverage and wind resistance. Low-trajectory spray and large water droplets prevent misting and airborne evaporation so the right amount of water is delivered to the right place. Gentle close-in watering eliminates dry-spots around the spray head
- HE-VAN nozzles throw to the exact specified radius, delivering the cleanest edge of any VAN on the market today
- Reduced zone run times, compared to competitive nozzles, help stay within tight watering windows, conserve water, and save money
- With full adjustability from 0° to 360°, you'll be able to efficiently water landscapes of all shapes, while saving time and stocking fewer nozzles
- Matched precipitation rates allow you to install Rain Bird HE-VAN, MPR and U-Series nozzles on the same zone
- HE-VAN nozzles have a tactile click to keep the arc setting from drifting over time
- Three year trade warranty

Operating Range

- Spacing: 6 to 15 feet (1.8 to 4.6m)¹
- Pressure: 15 to 30 psi (1.0 to 2.1 bar)
- Optimum pressure: 30 psi (2.1 bar)²

Models

- HE-VAN-08: 6 to 8 feet (1.8 to 2.4 m)
- HE-VAN-10: 8 to 10 feet (2.4 to 3.0 m)
- HE-VAN-12: 9 to 12 feet (2.7 to 3.7 m)
- HE-VAN-15: 12 to 15 feet (3.7 to 4.6 m)

¹ These ranges are based on proper pressure at nozzle

² Rain Bird recommends using 1800/RD1800 PRS Spray Bodies to maintain optimum nozzle performance in higher pressure situations



Available in popular 8', 10', 12' and 15' models

Fits on all Rain Bird® 1800® Series Spray Heads, UNI-Spray™ Series Spray Heads and Rain Bird Shrub Adapters

For Optimum Performance, Use Rain Bird 1800 30 PSI Regulated or RD1800 30 PSI Regulated Spray Bodies



How to Specify

HE-VAN-15

Radius Range
8: 6 to 8 feet (1.8 to 2.4 m)
10: 8 to 10 feet (2.4 to 3.0 m)
12: 9 to 12 feet (2.7 to 3.7 m)
15: 12 to 15 feet (3.7 to 4.6 m)

Feature
VAN: Variable Arc

Model
High Efficiency Nozzle



HE-VAN Nozzles meet the requirements of the ASABE/ICC 802-2014 standard





The average DU(LQ) of the applicable products exceed 0.65 distribution uniformity.

Product	Type	Radius	DU(LQ)
HE-VAN	Spray, Variable Arc	6 - 15 ft.	> 0.70

To view the complete document of compliance for Rain Bird products that have been tested to meet the requirements of the ASABE/ICC 802-2014 standard and the California MWELD go to: www.rainbird.com/agency/mwelo

8 Series HE-VAN





24° Trajectory

Nozzle	Pressure psi	Radius ft.	Flow gpm	■ Precip In/h	▲ Precip In/h
	15	5	0.83	3.19	3.68
	20	6	0.96	2.56	2.95
	25	7	1.07	2.10	2.42
	30	8	1.17	1.76	2.03
	15	5	0.62	3.19	3.68
	20	6	0.72	2.56	2.95
	25	7	0.80	2.10	2.42
	30	8	0.88	1.76	2.03
	15	5	0.41	3.19	3.68
	20	6	0.48	2.56	2.95
	25	7	0.53	2.10	2.42
	30	8	0.59	1.76	2.03
	15	5	0.21	3.19	3.68
	20	6	0.24	2.56	2.95
	25	7	0.27	2.10	2.42
	30	8	0.29	1.76	2.03

8 Series HE-VAN





METRIC

24° Trajectory

Nozzle	Pressure bar	Radius m	Flow m ³ /h	Flow l/m	■ Precip mm/h	▲ Precip mm/h
	1.0	1.5	0.19	3.14	82	95
	1.4	1.8	0.22	3.62	66	76
	1.7	2.1	0.25	4.05	54	62
	2.1	2.4	0.27	4.43	45	52
	1.0	1.5	0.14	2.35	82	95
	1.4	1.8	0.16	2.72	66	76
	1.7	2.1	0.18	3.04	54	62
	2.1	2.4	0.20	3.33	45	52
	1.0	1.5	0.10	1.57	82	95
	1.4	1.8	0.11	1.81	66	76
	1.7	2.1	0.12	2.02	54	62
	2.1	2.4	0.13	2.22	45	52
	1.0	1.5	0.05	0.78	82	95
	1.4	1.8	0.05	0.91	66	76
	1.7	2.1	0.06	1.01	54	62
	2.1	2.4	0.07	1.11	45	52

10 Series HE-VAN





27° Trajectory

Nozzle	Pressure psi	Radius ft.	Flow gpm	■ Precip In/h	▲ Precip In/h
	15	7	1.26	2.48	2.86
	20	8	1.46	2.19	2.53
	25	9	1.63	1.94	2.24
	30	10	1.78	1.72	1.98
	15	7	0.95	2.48	2.86
	20	8	1.09	2.19	2.53
	25	9	1.22	1.94	2.24
	30	10	1.34	1.72	1.98
	15	7	0.63	2.48	2.86
	20	8	0.73	2.19	2.53
	25	9	0.81	1.94	2.24
	30	10	0.89	1.72	1.98
	15	7	0.32	2.48	2.86
	20	8	0.36	2.19	2.53
	25	9	0.41	1.94	2.24
	30	10	0.45	1.72	1.98

10 Series HE-VAN

METRIC

27° Trajectory

Nozzle	Pressure bar	Radius m	Flow m ³ /h	Flow l/m	■ Precip mm/h	▲ Precip mm/h
	1.0	2.1	0.29	4.78	64	74
	1.4	2.4	0.34	5.52	56	65
	1.7	2.7	0.37	6.17	50	57
	2.1	3.1	0.41	6.76	44	51
	1.0	2.1	0.22	3.59	64	74
	1.4	2.4	0.25	4.14	56	65
	1.7	2.7	0.28	4.63	50	57
	2.1	3.1	0.31	5.07	44	51
	1.0	2.1	0.15	2.39	64	74
	1.4	2.4	0.17	2.76	56	65
	1.7	2.7	0.19	3.09	50	57
	2.1	3.1	0.21	3.38	44	51
	1.0	2.1	0.07	1.20	64	74
	1.4	2.4	0.08	1.38	56	65
	1.7	2.7	0.09	1.54	50	57
	2.1	3.1	0.10	1.69	44	51





Note: All HE-VAN nozzles tested on 4" (10.2 cm) pop-ups





■ Square spacing based on 50% diameter of throw





▲ Triangular spacing based on 50% diameter of throw





Performance data taken in zero wind conditions

Note: Radius reduction over 25% of the normal throw of the nozzle is not recommended

12 Series HE-VAN					
23° Trajectory					
Nozzle	Pressure psi	Radius ft.	Flow gpm	■ Precip In/h	▲ Precip In/h
	15	9	1.67	1.99	2.30
	20	10	1.93	1.86	2.15
	25	11	2.16	1.72	1.99
	30	12	2.37	1.58	1.83
	15	9	1.25	1.99	2.30
	20	10	1.45	1.86	2.15
	25	11	1.62	1.72	1.99
	30	12	1.77	1.58	1.83
	15	9	0.84	1.99	2.30
	20	10	0.97	1.86	2.15
	25	11	1.08	1.72	1.99
	30	12	1.18	1.58	1.83
	15	9	0.42	1.99	2.30
	20	10	0.48	1.86	2.15
	25	11	0.54	1.72	1.99
	30	12	0.59	1.58	1.83

12 Series HE-VAN						METRIC
23° Trajectory						
Nozzle	Pressure bar	Radius m	Flow m³/h	Flow l/m	■ Precip mm/h	▲ Precip mm/h
	1.0	2.7	0.38	6.33	50.5	58.3
	1.4	3.0	0.44	7.31	47.3	54.6
	1.7	3.4	0.49	8.18	43.7	50.4
	2.1	3.7	0.54	8.96	40.2	46.4
	1.0	2.7	0.28	4.75	50.5	58.3
	1.4	3.0	0.33	5.48	47.3	54.6
	1.7	3.4	0.37	6.16	43.7	50.4
	2.1	3.7	0.40	6.72	40.2	46.4
	1.0	2.7	0.19	3.17	50.5	58.3
	1.4	3.0	0.22	3.66	47.3	54.6
	1.7	3.4	0.25	4.09	43.7	50.4
	2.1	3.7	0.27	4.48	40.2	46.4
	1.0	2.7	0.09	1.58	50.5	58.3
	1.4	3.0	0.11	1.83	47.3	54.6
	1.7	3.4	0.12	2.04	43.7	50.4
	2.1	3.7	0.13	2.24	40.2	46.4

15 Series HE-VAN					
25° Trajectory					
Nozzle	Pressure psi	Radius ft.	Flow gpm	■ Precip In/h	▲ Precip In/h
	15	11	2.62	2.08	2.40
	20	12	3.02	2.02	2.33
	25	14	3.38	1.66	1.92
	30	15	3.70	1.58	1.83
	15	11	1.96	2.08	2.40
	20	12	2.27	2.02	2.33
	25	14	2.53	1.66	1.92
	30	15	2.78	1.58	1.83
	15	11	1.31	2.08	2.40
	20	12	1.51	2.02	2.33
	25	14	1.69	1.66	1.92
	30	15	1.85	1.58	1.83
	15	11	0.65	2.08	2.40
	20	12	0.76	2.02	2.33
	25	14	0.84	1.66	1.92
	30	15	0.93	1.58	1.83

15 Series HE-VAN						METRIC
25° Trajectory						
Nozzle	Pressure bar	Radius m	Flow m³/h	Flow l/m	■ Precip mm/h	▲ Precip mm/h
	1.0	3.4	0.59	9.91	52.9	61.1
	1.4	3.7	0.69	11.44	51.3	59.3
	1.7	4.3	0.77	12.79	42.2	48.7
	2.1	4.6	0.84	14.01	40.2	46.5
	1.0	3.4	0.45	7.43	52.9	61.1
	1.4	3.7	0.51	8.58	51.3	59.3
	1.7	4.3	0.58	9.59	42.2	48.7
	2.1	4.6	0.63	10.51	40.2	46.5
	1.0	3.4	0.30	4.95	52.9	61.1
	1.4	3.7	0.34	5.72	51.3	59.3
	1.7	4.3	0.38	6.39	42.2	48.7
	2.1	4.6	0.42	7.00	40.2	46.5
	1.0	3.4	0.15	2.48	52.9	61.1
	1.4	3.7	0.17	2.86	51.3	59.3
	1.7	4.3	0.19	3.20	42.2	48.7
	2.1	4.6	0.21	3.50	40.2	46.5

Note: All HE-VAN nozzles tested on 4" (10.2 cm) pop-ups
 ■ Square spacing based on 50% diameter of throw
 ▲ Triangular spacing based on 50% diameter of throw

Performance data taken in zero wind conditions
Note: Radius reduction over 25% of the normal throw of the nozzle is not recommended

Spray & Rotary Nozzles

U-Series Nozzles

Dual orifice spray nozzles that use 30% less water¹

Features

- Additional orifice for close-in watering minimizes brown spots around the spray head and eliminates gaps in coverage so the entire watering area is more uniformly covered
- Superior coverage for efficient watering. Use up to 30% less water
- Matched precipitation rate with Rain Bird HE-VAN and MPR nozzles
- Five year trade warranty

Operating Range

- Spacing: 5 to 15 feet (1.7 to 4.6 m)²
- Pressure: 15 to 30 psi (1.0 to 2.1 bar)
- Optimum pressure: 30 psi (2.1 bar)³

Models

- U-8 Series: 8-foot Quarter, Half, Full nozzles
- U-10 Series: 10-foot Quarter, Half, Full nozzles
- U-12 Series: 12-foot Quarter, Half, Full nozzles
- U-15 Series: 15-foot Quarter, Half, Full nozzles

¹ When U-Series dual-orifice nozzles are installed instead of standard nozzles on every spray body in the zone. Results may vary based on site-specific conditions such as sprinkler spacing, wind, temperature, soil and grass type.

² These ranges are based on proper pressure at nozzle.

³ Rain Bird recommends using 1800/RD1800 PRS Spray Bodies to maintain optimum nozzle performance in higher pressure situations.



U-Series Nozzles



U-Series Nozzle with screen



U-Series nozzles offer better, more uniform water distribution. Water flowing from both orifices combines to form a continuous water stream. Eliminates gaps for more uniform coverage throughout the entire watering area

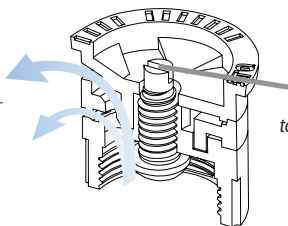

Stainless steel adjustment screw to adjust flow and radius

Fits all Rain Bird Spray Bodies and Shrub Adapters

For Optimum Performance, Use Rain Bird 1800 30 PSI Regulated or RD1800 30 PSI Regulated Spray Bodies



How to Specify

U12H

Radius Range
8: 5-8 feet (1.7-2.4 m)
10: 7-10 feet (2.1-3.1 m)
12: 9-12 feet (2.7-3.7 m)
15: 11-15 feet (3.4-4.6 m)

Pattern
F: Full
H: Half
Q: Quarter

Model
U-Series Nozzle



U-Series Nozzles meet the requirements of the ASABE/ICC 802-2014 standard



The average DU(LQ) of the applicable products exceed 0.65 distribution uniformity.



Product	Type	Radius	DU(LQ)
U-Series	Spray, Fixed Arc	6 - 15 ft.	> 0.70



To view the complete document of compliance for Rain Bird products that have been tested to meet the requirements of the ASABE/ICC 802-2014 standard and the California MWELO go to: www.rainbird.com/agency/mwelo



U8 Series					
10° Trajectory					
Nozzle	Pressure psi	Radius ft.	Flow gpm	■ Precip In/h	▲ Precip In/h
 U-8F	15	5	0.74	2.85	3.29
	20	6	0.86	2.30	2.66
	25	7	0.96	1.89	2.18
	30	8	1.05	1.58	1.83
 U-8H	15	5	0.37	2.85	3.29
	20	6	0.42	2.25	2.59
	25	7	0.47	1.85	2.13
	30	8	0.52	1.58	1.83
 U-8Q	15	5	0.18	2.77	3.20
	20	6	0.21	2.25	2.59
	25	7	0.24	1.89	2.18
	30	8	0.26	1.58	1.83



U8 Series						METRIC
10° Trajectory						
Nozzle	Pressure bar	Radius m	Flow m³/h	Flow l/m	■ Precip mm/h	▲ Precip mm/h
 U-8F	1.0	1.7	0.16	2.8	72	84
	1.5	2.1	0.20	3.4	58	68
	2.0	2.4	0.23	3.9	48	55
	2.1	2.4	0.24	4.0	40	46
 U-8H	1.0	1.7	0.08	1.4	72	84
	1.5	2.1	0.10	1.7	57	66
	2.0	2.4	0.12	1.9	47	54
	2.1	2.4	0.12	2.0	40	46
 U-8Q	1.0	1.7	0.04	0.7	70	81
	1.5	2.1	0.05	0.8	57	66
	2.0	2.4	0.06	1.0	48	55
	2.1	2.4	0.06	1.0	40	46



U10 Series					
12° Trajectory					
Nozzle	Pressure psi	Radius ft.	Flow gpm	■ Precip In/h	▲ Precip In/h
 U-10F	15	7	1.16	2.07	2.39
	20	8	1.34	2.01	2.32
	25	9	1.50	1.62	1.87
	30	10	1.64	1.58	1.83
 U-10H	15	7	0.58	2.07	2.39
	20	8	0.67	2.01	2.32
	25	9	0.75	1.62	1.87
	30	10	0.82	1.58	1.83
 U-10Q	15	7	0.29	2.07	2.39
	20	8	0.33	2.01	2.32
	25	9	0.37	1.62	1.87
	30	10	0.41	1.58	1.83



U10 Series						METRIC
12° Trajectory						
Nozzle	Pressure bar	Radius m	Flow m³/h	Flow l/m	■ Precip mm/h	▲ Precip mm/h
 U-10F	1.0	2.1	0.26	4.4	52	60
	1.5	2.6	0.30	5.3	47	55
	2.0	3.0	0.34	6.1	41	48
	2.1	3.1	0.37	6.2	40	46
 U-10H	1.0	2.1	0.13	2.2	52	60
	1.5	2.6	0.15	2.6	47	55
	2.0	3.0	0.17	3.1	41	48
	2.1	3.1	0.19	3.1	40	46
 U-10Q	1.0	2.1	0.07	1.1	52	60
	1.5	2.6	0.08	1.3	47	55
	2.0	3.0	0.08	1.5	41	48
	2.1	3.1	0.09	1.6	40	46



Note: All U-Series nozzles tested on 4" (10.2 cm) pop-ups
 ■ Square spacing based on 50% diameter of throw
 ▲ Triangular spacing based on 50% diameter of throw

Performance data taken in zero wind conditions
 Radius refers to recommended product spacing. Actual radii along arc may vary

U12 Series					
23° Trajectory					
Nozzle	Pressure psi	Radius ft.	Flow gpm	■ Precip In/h	▲ Precip In/h
 U-12F	15	9	1.80	2.14	2.47
	20	10	2.10	2.02	2.34
	25	11	2.40	1.91	2.21
	30	12	2.60	1.74	2.01
 U-12H	15	9	0.90	2.14	2.47
	20	10	1.05	2.02	2.34
	25	11	1.20	1.91	2.21
	30	12	1.30	1.74	2.01
 U-12Q	15	9	0.45	2.14	2.47
	20	10	0.53	2.02	2.34
	25	11	0.60	1.91	2.21
	30	12	0.65	1.74	2.01

U12 Series						METRIC	
23° Trajectory						■	▲
Nozzle	Pressure bar	Radius m	Flow m ³ /h	Flow l/m	Precip mm/h	Precip mm/h	
 U-12F	1.0	2.7	0.40	6.8	55	63	
	1.5	3.2	0.48	8.3	47	54	
	2.0	3.6	0.59	9.7	46	53	
	2.1	3.7	0.60	9.8	44	51	
 U-12H	1.0	2.7	0.20	3.4	55	63	
	1.5	3.2	0.24	4.2	47	54	
	2.0	3.6	0.30	4.8	46	53	
	2.1	3.7	0.30	4.9	44	51	
 U-12Q	1.0	2.7	0.10	1.7	55	63	
	1.5	3.2	0.12	2.1	47	54	
	2.0	3.6	0.15	2.4	46	53	
	2.1	3.7	0.15	2.5	44	51	

U15 Series					
23° Trajectory					
Nozzle	Pressure psi	Radius ft.	Flow gpm	■ Precip In/h	▲ Precip In/h
 U-15F	15	11	2.60	2.07	2.39
	20	12	3.00	2.01	2.32
	25	14	3.30	1.62	1.87
	30	15	3.70	1.58	1.83
 U-15H	15	11	1.30	2.07	2.39
	20	12	1.50	2.01	2.32
	25	14	1.65	1.62	1.87
	30	15	1.85	1.58	1.83
 U-15Q	15	11	0.65	2.07	2.39
	20	12	0.75	2.01	2.32
	25	14	0.82	1.62	1.87
	30	15	0.92	1.58	1.83

U15 Series						METRIC	
23° Trajectory						■	▲
Nozzle	Pressure bar	Radius m	Flow m ³ /h	Flow l/m	Precip mm/h	Precip mm/h	
 U-15F	1.0	3.4	0.60	9.8	52	60	
	1.5	3.9	0.72	11.8	47	55	
	2.0	4.5	0.84	13.7	41	48	
	2.1	4.6	0.84	14.0	40	46	
 U-15H	1.0	3.4	0.30	4.9	52	60	
	1.5	3.9	0.36	5.9	47	55	
	2.0	4.5	0.42	6.9	41	48	
	2.1	4.6	0.42	7.0	40	46	
 U-15Q	1.0	3.4	0.15	2.5	52	60	
	1.5	3.9	0.18	2.9	47	55	
	2.0	4.5	0.21	3.4	41	48	
	2.1	4.6	0.21	3.5	40	46	

Note: All U-Series nozzles tested on 4" (10.2 cm) pop-ups
 ■ Square spacing based on 50% diameter of throw
 ▲ Triangular spacing based on 50% diameter of throw

Performance data taken in zero wind conditions
 Radius refers to recommended product spacing. Actual radii along arc may vary

VAN Series Nozzles

Variable Arc Nozzles

Features

- A simple twist of the center collar with no special tools increases or decreases the arc setting making it ideal for watering odd shaped areas
- Quickly identify radius with Top Color-coded™ nozzles even when system is not operating
- 12, 15, and 18-VAN have matched precipitation rates with Rain Bird MPR Nozzles
- Three year trade warranty

Operating Range

- Spacing: 3 to 18 feet (0.9 m to 5.5 m)¹
- Pressure: 15 to 30 psi (1.0 to 2.1 bar)
- Optimum pressure: 30 psi (2.1 bar)²

Models

- 4-VAN Series: 3 to 4 feet (0.9 to 1.2 m)
- 6-VAN Series: 4 to 6 feet (1.2 to 1.8 m)
- 8-VAN Series: 6 to 8 feet (1.8 to 2.4 m)
- 10-VAN Series: 7 to 10 feet (2.1 to 3.1 m)
- 12-VAN Series: 9 to 12 feet (2.7 to 3.7 m)
- 15-VAN Series: 11 to 15 feet (3.4 to 4.6 m)
- 18-VAN Series: 14 to 18 feet (4.3 to 5.5 m)

¹ These ranges are based on proper pressure at nozzle.

² Rain Bird recommends using 1800 PRS Spray Bodies to maintain optimum nozzle performance in higher pressure situations.

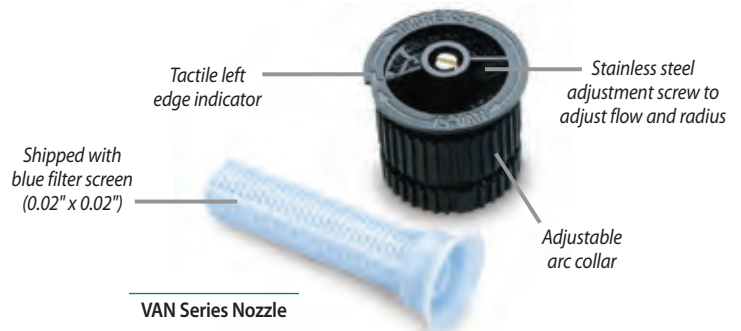

VAN Series Nozzle



For Optimum Performance,
Use Rain Bird 1800-SAM-PRS
30 PSI Regulated or
RD1800-SAM-PRS 30 PSI
Regulated Spray Bodies



How to Specify





8 VAN

Radius Range

- 4: 3-4 feet (0.9-1.2 m)
- 6: 4-6 feet (1.2-1.8 m)
- 8: 6-8 feet (1.8-2.4 m)
- 10: 7-10 feet (2.1-3.0 m)
- 12: 9-12 feet (2.7-3.7 m)
- 15: 11-15 feet (3.4-4.6 m)
- 18: 14-18 feet (4.3-5.5 m)

Nozzle Type





VAN: Variable Arc Nozzle

4 Series VAN					
0° Trajectory					
Nozzle	Pressure psi	Radius ft.	Flow gpm	Precip In/h	Precip In/h
	15	3	0.62	7.23	8.35
	20	3	0.70	8.17	9.43
	25	4	0.80	5.25	6.06
	30	4	0.88	5.78	6.67
	15	3	0.52	7.42	8.57
	20	3	0.58	8.27	9.55
	25	4	0.66	5.29	6.11
	30	4	0.73	5.86	6.77
	15	3	0.32	6.84	7.90
	20	3	0.37	7.91	9.13
	25	4	0.41	4.93	5.69
	30	4	0.45	5.41	6.25
	15	3	0.21	8.98	10.37
	20	3	0.24	10.27	11.86
	25	4	0.26	6.26	7.23
	30	4	0.29	6.98	8.06

Note: All VAN nozzles tested on 4" (10.2 cm) pop-ups





■ Square spacing based on 50% diameter of throw





▲ Triangular spacing based on 50% diameter of throw





4 Series VAN						METRIC	
0° Trajectory							
Nozzle	Pressure bar	Radius m	Flow m ³ /h	Flow l/m	Precip mm/h	Precip mm/h	
	1.0	0.9	0.14	2.3	189	218	
	1.5	1.0	0.17	2.8	183	215	
	2.0	1.2	0.20	3.3	152	176	
	2.1	1.2	0.20	3.3	152	176	
	1.0	0.9	0.12	2.0	198	229	
	1.5	1.0	0.14	2.3	187	216	
	2.0	1.2	0.16	2.7	148	171	
	2.1	1.2	0.17	2.8	157	181	
	1.0	0.9	0.07	1.2	173	200	
	1.5	1.0	0.09	1.5	180	208	
	2.0	1.2	0.10	1.7	139	161	
	2.1	1.2	0.10	1.7	139	161	
	1.0	0.9	0.05	0.8	247	285	
	1.5	1.0	0.06	0.9	240	277	
	2.0	1.2	0.06	1.1	167	193	
	2.1	1.2	0.07	1.1	194	224	





Performance data taken in zero wind conditions

Note: Radius reduction over 25% of the normal throw of the nozzle is not recommended

6 Series VAN					
0° Trajectory					
Nozzle	Pressure psi	Radius ft.	Flow gpm	■ Precip In/h	▲ Precip In/h
	15	4	0.85	5.58	6.44
	20	5	0.96	4.03	4.65
	25	5	1.09	4.58	5.29
	30	6	1.20	3.50	4.04
	15	4	0.79	6.34	7.32
	20	5	0.88	4.52	5.22
	25	5	1.00	5.13	5.92
	30	6	1.10	3.92	4.53
	15	4	0.42	5.05	5.83
	20	5	0.49	3.77	4.35
	25	5	0.55	4.24	4.90
	30	6	0.60	3.21	3.71
	15	4	0.26	6.26	7.23
	20	5	0.30	4.62	5.33
	25	5	0.34	5.24	6.05
	30	6	0.37	3.96	4.57

6 Series VAN						METRIC	
0° Trajectory							
Nozzle	Pressure bar	Radius m	Flow m³/h	Flow l/m	■ Precip mm/h	▲ Precip mm/h	
	1.0	1.2	0.19	3.2	144	166	
	1.5	1.5	0.23	3.8	112	129	
	2.0	1.8	0.27	4.5	91	105	
	2.1	1.8	0.27	4.5	91	105	
	1.0	1.2	0.18	3.0	167	193	
	1.5	1.5	0.21	3.5	124	143	
	2.0	1.8	0.24	4.1	99	114	
	2.1	1.8	0.25	4.2	103	119	
	1.0	1.2	0.10	1.6	139	161	
	1.5	1.5	0.11	1.9	98	113	
	2.0	1.8	0.13	2.2	80	92	
	2.1	1.8	0.14	2.3	86	99	
	1.0	1.2	0.06	1.0	167	193	
	1.5	1.5	0.07	1.2	124	143	
	2.0	1.8	0.08	1.4	99	114	
	2.1	1.8	0.08	1.4	99	114	

8 Series VAN					
5° Trajectory					
Nozzle	Pressure psi	Radius ft.	Flow gpm	■ Precip In/h	▲ Precip In/h
	15	6	1.21	3.53	4.07
	20	7	1.36	2.91	3.36
	25	7	1.55	3.32	3.83
	30	8	1.70	2.79	3.22
	15	6	1.11	3.95	4.55
	20	7	1.24	3.24	3.74
	25	7	1.41	3.69	4.25
	30	8	1.55	3.10	3.58
	15	6	0.84	4.49	5.18
	20	7	0.97	3.81	4.40
	25	7	1.09	4.28	4.94
	30	8	1.19	3.58	4.13
	15	6	0.51	5.46	6.29
	20	7	0.59	4.64	5.35
	25	7	0.66	5.19	5.98
	30	8	0.72	4.33	5.00

8 Series VAN						METRIC	
5° Trajectory							
Nozzle	Pressure bar	Radius m	Flow m³/h	Flow l/m	■ Precip mm/h	▲ Precip mm/h	
	1.0	1.8	0.27	4.6	91	105	
	1.5	2.1	0.32	5.4	79	91	
	2.0	2.3	0.38	6.3	78	90	
	2.1	2.4	0.39	6.4	74	86	
	1.0	1.8	0.25	4.2	103	119	
	1.5	2.1	0.30	4.9	91	105	
	2.0	2.3	0.34	5.8	86	99	
	2.1	2.4	0.35	5.9	81	94	
	1.0	1.8	0.19	3.2	117	135	
	1.5	2.1	0.23	3.8	104	120	
	2.0	2.3	0.26	4.4	98	113	
	2.1	2.4	0.27	4.5	94	109	
	1.0	1.8	0.12	1.9	148	171	
	1.5	2.1	0.14	2.3	127	147	
	2.0	2.3	0.16	2.7	121	140	
	2.1	2.4	0.16	2.7	111	128	

Note: All VAN nozzles tested on 4" (10.2 cm) pop-ups
 ■ Square spacing based on 50% diameter of throw
 ▲ Triangular spacing based on 50% diameter of throw





Performance data taken in zero wind conditions
Note: Radius reduction over 25% of the normal throw of the nozzle is not recommended





Did you know?





You can use HE-VAN nozzles to have better coverage and save water vs. VAN nozzles.





- Stronger streams and larger water droplets for increased wind resistance.
- Superior close-in watering and edges provide better coverage.
- Shortened run times saves up to 35% in water



10 Series VAN					
10° Trajectory					
Nozzle	Pressure psi	Radius ft.	Flow gpm	■ Precip In/h	▲ Precip In/h
	15	7	1.93	3.80	4.39
	20	8	2.32	3.50	4.04
	25	9	2.52	3.00	3.46
	30	10	2.60	2.50	2.89
	15	7	1.45	3.80	4.39
	20	8	1.75	3.50	4.04
	25	9	1.89	3.00	3.46
	30	10	2.10	2.70	3.12
	15	7	0.97	3.80	4.39
	20	8	1.20	3.50	4.04
	25	9	1.26	3.00	3.46
	30	10	1.45	2.80	3.23
	15	7	0.48	3.80	4.39
	20	8	0.58	3.50	4.04
	25	9	0.63	3.00	3.46
	30	10	0.75	2.90	3.35

10 Series VAN						METRIC	
10° Trajectory							
Nozzle	Pressure bar	Radius m	Flow m ³ /h	Flow l/m	■ Precip mm/h	▲ Precip mm/h	
	1.0	2.1	0.44	7.3	96	111	
	1.5	2.4	0.53	9.0	89	103	
	2.0	2.7	0.57	9.8	76	88	
	2.1	3.1	0.59	9.8	63	73	
	2.1	3.1	0.59	9.8	63	73	
	1.0	2.1	0.33	5.5	96	111	
	1.5	2.4	0.4	6.8	89	103	
	2.0	2.7	0.43	7.8	76	88	
	2.1	3.1	0.48	7.9	68	79	
	2.1	3.1	0.48	7.9	68	79	
	1.0	2.1	0.22	3.7	96	111	
	1.5	2.4	0.27	4.6	89	103	
	2.0	2.7	0.29	5.3	76	88	
	2.1	3.1	0.33	5.5	71	82	
	2.1	3.1	0.33	5.5	71	82	
	1.0	2.1	0.11	1.8	96	111	
	1.5	2.4	0.13	2.3	89	103	
	2.0	2.7	0.14	2.7	76	88	
	2.1	3.1	0.17	2.8	73	85	
	2.1	3.1	0.17	2.8	73	85	

12 Series VAN					
15° Trajectory					
Nozzle	Pressure psi	Radius ft.	Flow gpm	■ Precip In/h	▲ Precip In/h
	15	9	1.56	1.86	2.14
	20	10	1.86	1.79	2.06
	25	11	2.12	1.68	1.95
	30	12	2.36	1.58	1.82
	15	9	1.17	1.86	2.14
	20	10	1.39	1.79	2.06
	25	11	1.59	1.68	1.94
	30	12	1.77	1.58	1.82
	15	9	0.78	1.86	2.14
	20	10	0.93	1.79	2.06
	25	11	1.06	1.68	1.95
	30	12	1.18	1.58	1.82
	15	9	0.39	1.86	2.14
	20	10	0.46	1.79	2.06
	25	11	0.53	1.68	1.95
	30	12	0.59	1.58	1.82

12 Series VAN						METRIC	
15° Trajectory							
Nozzle	Pressure bar	Radius m	Flow m ³ /h	Flow l/m	■ Precip mm/h	▲ Precip mm/h	
	1.0	2.7	0.35	5.80	48	55	
	1.5	3.2	0.44	7.37	43	50	
	2.0	3.6	0.52	8.75	41	47	
	2.1	3.7	0.54	9.02	40	46	
	2.1	3.7	0.54	9.02	40	46	
	1.0	2.7	0.26	4.35	48	55	
	1.5	3.2	0.33	5.53	43	50	
	2.0	3.6	0.39	6.56	41	47	
	2.1	3.7	0.41	6.76	40	46	
	2.1	3.7	0.41	6.76	40	46	
	1.0	2.7	0.17	2.90	48	55	
	1.5	3.2	0.22	3.69	43	50	
	2.0	3.6	0.26	4.37	41	47	
	2.1	3.7	0.27	4.51	40	46	
	2.1	3.7	0.27	4.51	40	46	
	1.0	2.7	0.09	1.45	48	55	
	1.5	3.2	0.11	1.84	43	50	
	2.0	3.6	0.13	2.19	41	47	
	2.1	3.7	0.14	2.25	40	46	
	2.1	3.7	0.14	2.25	40	46	

Note: All VAN nozzles tested on 4" (10.2 cm) pop-ups
 ■ Square spacing based on 50% diameter of throw
 ▲ Triangular spacing based on 50% diameter of throw





Performance data taken in zero wind conditions
Note: Radius reduction over 25% of the normal throw of the nozzle is not recommended





Did you know?





You can use HE-VAN nozzles to have better coverage and save water vs. VAN nozzles.





- Stronger streams and larger water droplets for increased wind resistance.
- Superior close-in watering and edges provide better coverage.
- Shortened run times saves up to 35% in water



15 Series VAN						
23° Trajectory						
Nozzle	Pressure psi	Radius ft.	Flow gpm	■ Precip In/h	▲ Precip In/h	
	360° Arc	15	11	2.60	2.07	2.39
		20	12	3.00	2.01	2.32
		25	14	3.30	1.62	1.87
		30	15	3.70	1.58	1.83
	270° Arc	15	11	1.95	2.07	2.39
		20	12	2.25	2.01	2.32
		25	14	2.48	1.62	1.87
		30	15	2.78	1.58	1.83
	180° Arc	15	11	1.30	2.07	2.39
		20	12	1.50	2.01	2.32
		25	14	1.65	1.62	1.87
		30	15	1.85	1.58	1.83
	90° Arc	15	11	0.65	2.07	2.39
		20	12	0.75	2.01	2.32
		25	14	0.82	1.62	1.87
		30	15	0.92	1.58	1.83

15 Series VAN						METRIC	
23° Trajectory							
Nozzle	Pressure bar	Radius m	Flow m³/h	Flow l/m	■ Precip mm/h	▲ Precip mm/h	
	360° Arc	1.0	3.4	0.60	9.8	52	60
		1.5	3.9	0.72	11.8	47	55
		2.0	4.5	0.84	13.7	41	48
		2.1	4.6	0.84	14.0	40	46
	270° Arc	1.0	3.4	0.45	7.4	52	60
		1.5	3.9	0.54	8.8	47	55
		2.0	4.5	0.63	10.3	41	48
		2.1	4.6	0.63	10.5	40	46
	180° Arc	1.0	3.4	0.30	4.9	52	60
		1.5	3.9	0.36	5.9	47	55
		2.0	4.5	0.42	6.9	41	48
		2.1	4.6	0.42	7.0	40	46
	90° Arc	1.0	3.4	0.15	2.5	52	60
		1.5	3.9	0.18	2.9	47	55
		2.0	4.5	0.21	3.4	41	48
		2.1	4.6	0.21	3.5	40	46

18 Series VAN						
26° Trajectory						
Nozzle	Pressure psi	Radius ft.	Flow gpm	■ Precip In/h	▲ Precip In/h	
	360° Arc	15	14	4.21	2.07	2.39
		20	15	4.70	2.01	2.32
		25	17	4.86	1.62	1.87
		30	18	5.32	1.58	1.83
	270° Arc	15	14	3.16	2.07	2.39
		20	15	3.52	2.01	2.32
		25	17	3.65	1.62	1.87
		30	18	3.99	1.58	1.83
	180° Arc	15	14	2.11	2.07	2.39
		20	15	2.35	2.01	2.32
		25	17	2.43	1.62	1.87
		30	18	2.66	1.58	1.83
	90° Arc	15	14	1.05	2.07	2.39
		20	15	1.17	2.01	2.32
		25	17	1.22	1.62	1.87
		30	18	1.33	1.58	1.83

18 Series VAN						METRIC	
26° Trajectory							
Nozzle	Pressure bar	Radius m	Flow m³/h	Flow l/m	■ Precip mm/h	▲ Precip mm/h	
	360° Arc	1.0	4.3	0.96	15.9	52	60
		1.5	4.8	1.07	18.0	47	55
		2.0	5.4	1.20	19.8	41	48
		2.1	5.5	1.21	20.1	40	46
	270° Arc	1.0	4.3	0.72	12.0	52	60
		1.5	4.8	0.80	13.5	47	55
		2.0	5.4	0.90	14.8	41	48
		2.1	5.5	0.91	15.1	40	46
	180° Arc	1.0	4.3	0.48	8.0	52	60
		1.5	4.8	0.54	9.0	47	55
		2.0	5.4	0.60	9.9	41	48
		2.1	5.5	0.61	10.1	40	46
	90° Arc	1.0	4.3	0.24	4.0	52	60
		1.5	4.8	0.27	4.5	47	55
		2.0	5.4	0.30	5.0	41	48
		2.1	5.5	0.30	5.0	40	46

Note: All VAN nozzles tested on 4" (10.2 cm) pop-ups
 ■ Square spacing based on 50% diameter of throw
 ▲ Triangular spacing based on 50% diameter of throw

Performance data taken in zero wind conditions
Note: Radius reduction over 25% of the normal throw of the nozzle is not recommended

Did you know?

You can use HE-VAN nozzles to have better coverage and save water vs. VAN nozzles.

- Stronger streams and larger water droplets for increased wind resistance.
- Superior close-in watering and edges provide better coverage.
- Shortened run times saves up to 35% in water



MPR Spray Nozzles

Matched Precipitation Rate Nozzles

Features

- Matched precipitation rates across sets and patterns in 5 Series, 8 Series, 10 Series, 12 Series, and 15 Series for even water distribution and design flexibility
- MPR Nozzles are installed by more contractors than all other brands combined
- Quickly identify radius and arc with Top Color-coded™ nozzles even when system is not operating
- Three year trade warranty

Operating Range

- Spacing: 3 to 15 feet (0.9 to 4.6 m)¹
- Pressure: 15 to 30 psi (1 to 2.1 bar)
- Optimum pressure: 30 psi (2.1 bar)²

Models

- 5 Series: Quarter, Half, Full Nozzles
- 5 Series: Bubbler Nozzles
- 8 Series: Quarter, Half, Full Nozzles
- 8 FLT Series: Designed for lower trajectory applications, such as windy areas
- 10 Series Nozzles
- 12 Series Nozzles
- 15 Series: Quarter, Half, Full Nozzles
- 15 Strip Series Nozzles

¹ These ranges are based on proper pressure at nozzle.

² Rain Bird recommends using 1800 PRS Spray Bodies to maintain optimum nozzle performance in higher pressure situations.



MPR Nozzle and Screen

How to Specify

5 F

Pattern
F: Full
H: Half
Q: Quarter



MPR Radius Range



5: 3-5 feet (1.1-1.5 m)
8: 5-8 feet (1.7-2.4 m)
10: 7-10 feet (2.1-3.1 m)
12: 9-12 feet (2.7-3.7 m)
15: 11-15 feet (3.4-4.6 m)



For Optimum Performance, Use
Rain Bird 1800 30 PSI Regulated or
RD1800 30 PSI Regulated Spray Bodies





Rain Bird® MPR Nozzles, The Industry Standard

5 Series MPR					
5° Trajectory					
Nozzle	Pressure psi	Radius ft.	Flow gpm	■ Precip In/h	▲ Precip In/h
5F 	15	3	0.29	3.10	3.58
	20	4	0.33	1.99	2.29
	25	4	0.37	2.23	2.57
	30	5	0.41	1.58	1.83
5H 	15	3	0.14	3.00	3.46
	20	4	0.16	1.93	2.22
	25	4	0.18	2.17	2.50
	30	5	0.20	1.54	1.78
5Q 	15	3	0.07	3.00	3.46
	20	4	0.08	1.93	2.22
	25	4	0.09	2.17	2.50
	30	5	0.10	1.54	1.78



5 Series MPR						METRIC	
5° Trajectory						■	▲
Nozzle	Pressure bar	Radius m	Flow m³/h	Flow l/m	Precip mm/h	Precip mm/h	
5F 	1.0	1.1	0.06	1.1	79	91	
	1.5	1.3	0.08	1.4	51	58	
	2.0	1.5	0.09	1.6	57	65	
	2.1	1.5	0.09	1.6	40	46	
5H 	1.0	1.1	0.03	0.5	76	88	
	1.5	1.3	0.04	0.7	49	56	
	2.0	1.5	0.04	0.7	55	64	
	2.1	1.5	0.05	0.9	39	45	
5Q 	1.0	1.1	0.02	0.4	76	88	
	1.5	1.3	0.02	0.4	49	56	
	2.0	1.5	0.02	0.4	55	64	
	2.1	1.5	0.02	0.4	39	45	



8 Series MPR					
10° Trajectory					
Nozzle	Pressure psi	Radius ft.	Flow gpm	■ Precip In/h	▲ Precip In/h
8F 	15	5	0.74	2.85	3.29
	20	6	0.86	2.30	2.66
	25	7	0.96	1.89	2.18
	30	8	1.05	1.58	1.82
8H 	15	5	0.37	2.85	3.29
	20	6	0.42	2.25	2.59
	25	7	0.47	1.85	2.13
	30	8	0.52	1.56	1.81
8Q 	15	5	0.18	2.77	3.20
	20	6	0.21	2.25	2.59
	25	7	0.24	1.89	2.18
	30	8	0.26	1.56	1.81



8 Series MPR						METRIC	
10° Trajectory						■	▲
Nozzle	Pressure bar	Radius m	Flow m³/h	Flow l/m	Precip mm/h	Precip mm/h	
8F 	1.0	1.7	0.16	2.8	72	84	
	1.5	2.1	0.20	3.4	58	68	
	2.0	2.4	0.23	3.9	48	55	
	2.1	2.4	0.24	4.0	40	46	
8H 	1.0	1.7	0.08	1.4	72	84	
	1.5	2.1	0.10	1.7	57	66	
	2.0	2.4	0.12	1.9	47	54	
	2.1	2.4	0.12	2.0	40	46	
8Q 	1.0	1.7	0.04	0.7	70	81	
	1.5	2.1	0.05	0.8	57	66	
	2.0	2.4	0.06	1.0	48	55	
	2.1	2.4	0.06	1.0	40	46	



Note: All MPR nozzles tested on 4" (10.2 cm) pop-ups
 ■ Square spacing based on 50% diameter of throw
 ▲ Triangular spacing based on 50% diameter of throw

Performance data taken in zero wind conditions
Note: Radius reduction over 25% of the normal throw of the nozzle is not recommended

10 Series MPR					
15° Trajectory					
Nozzle	Pressure psi	Radius ft.	Flow gpm	■ Precip In/h	▲ Precip In/h
10F 	15	7	1.16	2.28	2.63
	20	8	1.30	1.96	2.26
	25	9	1.44	1.71	1.98
	30	10	1.58	1.52	1.75
10H 	15	7	0.58	2.28	2.63
	20	8	0.65	1.96	2.26
	25	9	0.72	1.71	1.98
	30	10	0.79	1.52	1.75
10Q 	15	7	0.29	2.28	2.63
	20	8	0.33	1.96	2.26
	25	9	0.36	1.71	1.98
	30	10	0.39	1.52	1.75



10 Series MPR						METRIC	
15° Trajectory							
Nozzle	Pressure bar	Radius m	Flow m³/h	Flow l/m	■ Precip mm/h	▲ Precip mm/h	
10F 	1.0	2.1	0.26	4.2	58	67	
	1.5	2.4	0.29	4.8	50	58	
	2.0	3.0	0.35	6.0	39	45	
	2.1	3.1	0.36	6.0	37	43	
10H 	1.0	2.1	0.13	2.4	58	67	
	1.5	2.4	0.14	2.4	50	58	
	2.0	3.0	0.18	3.0	39	45	
	2.1	3.1	0.18	3.0	37	43	
10Q 	1.0	2.1	0.06	1.2	58	67	
	1.5	2.4	0.07	1.2	50	58	
	2.0	3.0	0.09	1.2	39	45	
	2.1	3.1	0.09	1.2	37	43	

12 Series MPR					
30° Trajectory					
Nozzle	Pressure psi	Radius ft.	Flow gpm	■ Precip In/h	▲ Precip In/h
12F 	15	9	1.80	2.14	2.47
	20	10	2.10	2.02	2.34
	25	11	2.40	1.91	2.21
	30	12	2.60	1.74	2.01
12H 	15	9	0.90	2.14	2.47
	20	10	1.05	2.02	2.34
	25	11	1.20	1.91	2.21
	30	12	1.30	1.74	2.01
12Q 	15	9	0.45	2.14	2.47
	20	10	0.53	2.02	2.34
	25	11	0.60	1.91	2.21
	30	12	0.65	1.74	2.01



12 Series MPR						METRIC	
30° Trajectory							
Nozzle	Pressure bar	Radius m	Flow m³/h	Flow l/m	■ Precip mm/h	▲ Precip mm/h	
12F 	1.0	2.7	0.40	6.8	55	63	
	1.5	3.2	0.48	8.3	47	54	
	2.0	3.6	0.59	9.7	46	53	
	2.1	3.7	0.60	9.8	44	51	
12H 	1.0	2.7	0.20	3.4	55	63	
	1.5	3.2	0.24	4.2	47	54	
	2.0	3.6	0.30	4.9	46	53	
	2.1	3.7	0.30	4.9	44	51	
12Q 	1.0	2.7	0.10	1.7	55	63	
	1.5	3.2	0.12	2.1	47	54	
	2.0	3.6	0.15	2.4	46	53	
	2.1	3.7	0.15	2.5	44	51	

Note: All MPR nozzles tested on 4" (10.2 cm) pop-ups
 ■ Square spacing based on 50% diameter of throw
 ▲ Triangular spacing based on 50% diameter of throw





Performance data taken in zero wind conditions
Note: Radius reduction over 25% of the normal throw of the nozzle is not recommended

15 Series MPR					
30° Trajectory					
Nozzle	Pressure psi	Radius ft.	Flow gpm	■ Precip In/h	▲ Precip In/h
15F 	15	11	2.60	2.07	2.39
	20	12	3.00	2.01	2.32
	25	14	3.30	1.62	1.87
	30	15	3.70	1.58	1.83
15H 	15	11	1.30	2.07	2.39
	20	12	1.50	2.01	2.32
	25	14	1.65	1.62	1.87
	30	15	1.85	1.58	1.83
15Q 	15	11	0.65	2.07	2.39
	20	12	0.75	2.01	2.32
	25	14	0.82	1.62	1.87
	30	15	0.92	1.58	1.83





Note: All MPR nozzles tested on 4" (10.2 cm) pop-ups
 ■ Square spacing based on 50% diameter of throw
 ▲ Triangular spacing based on 50% diameter of throw







15 Series MPR					METRIC	
30° Trajectory						
Nozzle	Pressure bar	Radius m	Flow m³/h	Flow l/m	■ Precip mm/h	▲ Precip mm/h
15F 	1.0	3.4	0.60	9.8	52	60
	1.5	3.9	0.72	11.8	47	55
	2.0	4.5	0.84	13.7	41	48
	2.1	4.6	0.84	14.0	40	46
15H 	1.0	3.4	0.30	4.9	52	60
	1.5	3.9	0.36	5.9	47	55
	2.0	4.5	0.42	6.8	41	48
	2.1	4.6	0.42	7.0	40	46
15Q 	1.0	3.4	0.15	2.5	52	60
	1.5	3.9	0.18	2.9	47	55
	2.0	4.5	0.21	3.4	41	48
	2.1	4.6	0.21	3.5	40	46

Performance data taken in zero wind conditions
Note: Radius reduction over 25% of the normal throw of the nozzle is not recommended







5 Series MPR Stream Bubbler Nozzles			
0° Trajectory			
Nozzle	Pressure psi	Radius ft.	Flow gpm
5F-B 	15	5	1.50
	20	5	1.50
	25	5	1.50
	30	5	1.50
5H-B 	15	5	1.00
	20	5	1.00
	25	5	1.00
	30	5	1.00
5Q-B 	15	5	0.50
	20	5	0.50
	25	5	0.50
	30	5	0.50
5CST-B 	15	5	0.50
	20	5	0.50
	25	5	0.50
	30	5	0.50

Note: Indicates adjusted radius at psi shown
Note: Flow at adjusted radius of 5 feet (1.5 m)



5 Series MPR Stream Bubbler Nozzles					METRIC
0° Trajectory					
Nozzle	Pressure bar	Radius m	Flow m³/h	Flow l/m	
5F-B 	1.0	1.5	0.35	5.7	
	1.5	1.5	0.35	5.7	
	2.0	1.5	0.35	5.7	
	2.1	1.5	0.35	5.7	
5H-B 	1.0	1.5	0.23	3.8	
	1.5	1.5	0.23	3.8	
	2.0	1.5	0.23	3.8	
	2.1	1.5	0.23	3.8	
5Q-B 	1.0	1.5	0.12	1.9	
	1.5	1.5	0.12	1.9	
	2.0	1.5	0.12	1.9	
	2.1	1.5	0.12	1.9	
5CST-B 	1.0	1.5	0.12	1.9	
	1.5	1.5	0.12	1.9	
	2.0	1.5	0.12	1.9	
	2.1	1.5	0.12	1.9	

15 Strip Series				
30° Trajectory				
Nozzle	Pressure psi	W x L ft.	Flow gpm	
 15EST	15	4 x 13	0.45	
	20	4 x 14	0.50	
	25	4 x 14	0.56	
	30	4 x 15	0.61	
 15CST	15	4 x 26	0.89	
	20	4 x 28	1.00	
	25	4 x 28	1.11	
	30	4 x 30	1.21	
 15RCS	15	3 x 11	0.35	
	20	3 x 12	0.40	
	25	4 x 14	0.45	
	30	4 x 15	0.49	
 15LCS	15	3 x 11	0.35	
	20	3 x 12	0.40	
	25	4 x 14	0.45	
	30	4 x 15	0.49	
 15SST	15	4 x 26	0.89	
	20	4 x 28	1.00	
	25	4 x 28	1.11	
	30	4 x 30	1.21	
 9SST	15	9 x 15	1.34	
	20	9 x 16	1.47	
	25	9 x 18	1.60	
	30	9 x 18	1.73	



W = Width of coverage pattern L = Length of coverage pattern
Note: Radius reduction over 25% of the normal throw of the nozzle is not recommended

15 Strip Series					METRIC
30° Trajectory					
Nozzle	Pressure bar	W x L m	Flow m ³ /h	Flow l/m	
 15EST	1.0	1.2 x 4.0	0.10	1.7	
	1.5	1.2 x 4.3	0.11	2.0	
	2.0	1.2 x 4.3	0.13	2.3	
	2.1	1.2 x 4.6	0.14	2.3	
 15CST	1.0	1.2 x 7.9	0.20	3.4	
	1.5	1.2 x 8.5	0.23	4.0	
	2.0	1.2 x 8.5	0.25	4.5	
	2.1	1.2 x 9.2	0.27	4.6	
 15RCS	1.0	0.8 x 3.2	0.08	1.3	
	1.5	1.0 x 3.9	0.09	1.6	
	2.0	1.2 x 4.5	0.11	1.8	
	2.1	1.2 x 4.6	0.11	1.9	
 15LCS	1.0	0.8 x 3.2	0.08	1.3	
	1.5	1.0 x 3.9	0.09	1.6	
	2.0	1.2 x 4.5	0.11	1.8	
	2.1	1.2 x 4.6	0.11	1.9	
 15SST	1.0	1.2 x 7.9	0.20	3.4	
	1.5	1.2 x 8.5	0.23	4.0	
	2.0	1.2 x 8.5	0.25	4.5	
	2.1	1.2 x 9.2	0.27	4.6	
 9SST	1.0	2.7 x 4.6	0.30	5.1	
	1.5	2.7 x 4.9	0.33	5.8	
	2.0	2.7 x 5.5	0.36	6.5	
	2.1	2.7 x 5.5	0.39	6.5	

Performance data taken in zero wind conditions

8 FLT Series MPR						
5° Trajectory						
Nozzle	Pressure psi	Radius ft.	Flow gpm	■ Precip In/h	▲ Precip In/h	
 8H-FLT	15	6	0.56	3.36	3.88	
	20	7	0.65	2.91	3.36	
	25	7	0.72	2.60	3.01	
	30	8	0.79	2.38	2.75	
 8Q-FLT	15	6	0.28	3.32	3.83	
	20	7	0.32	2.87	3.32	
	25	7	0.36	2.57	2.97	
	30	8	0.39	2.35	2.71	

Note: All MPR nozzles tested on 4" (10.2 cm) pop-ups
 ■ Square spacing based on 50% diameter of throw
 ▲ Triangular spacing based on 50% diameter of throw

8 FLT Series MPR							METRIC
5° Trajectory							
Nozzle	Pressure bar	Radius m	Flow m ³ /h	Flow l/m	■ Precip mm/h	▲ Precip mm/h	
 8H-FLT	1.0	1.7	0.12	2.1	87	101	
	1.5	2.1	0.15	2.6	71	82	
	2.0	2.4	0.18	2.9	62	71	
	2.1	2.4	0.18	3.0	60	70	
 8Q-FLT	1.0	1.7	0.06	1.1	86	100	
	1.5	2.1	0.07	1.3	71	81	
	2.0	2.4	0.09	1.4	61	71	
	2.1	2.4	0.09	1.5	60	69	

Performance data taken in zero wind conditions
Note: Radius reduction over 25% of the normal throw of the nozzle is not recommended

1300A-F

Adjustable Full-Circle Bubbler

Features

- Stainless Steel adjustment screw regulates flow and radius for spacing between from 1 to 3 feet (0.3 m to 0.9 m) apart
- Non-corrosive plastic and stainless steel construction for long life
- Shipped with SR-050 1/2" (15/21) inlet filter screen for easy installation and resistance to debris
- Operates over a wide range of pressures
- Five year trade warranty

Operating Range

- Flow: 1.0 to 2.3 gpm (3.6 to 8.4 l/m)
- Spacing: 1 to 3 feet (0.3 to 0.9 m)¹
- Pressure: 10 to 60 psi (0.7 to 4.1 bar)²

Model

- 1300A-F

¹ These ranges are based on proper pressure at nozzle

² Rain Bird recommends using 1800 PRS Spray Bodies to maintain optimum nozzle performance in higher pressure situations

1300A-F		
Nozzle	Pressure psi	Flow gpm
	10	1.0
	20	1.4
	30	1.7
	40	1.9
	50	2.1
	60	2.3

1300A-F		METRIC	
Nozzle	Pressure bar	Flow m ³ /h	Flow l/m
	0.7	0.23	3.6
	1.0	0.26	4.2
	1.5	0.30	4.8
	2.0	0.34	5.4
	2.5	0.39	6.0
	3.0	0.43	7.2
	3.5	0.48	7.8
	4.0	0.52	8.4
	4.1	0.53	8.4



1300A-F

1400 Series

Pressure Compensating Full-Circle Bubblers

Features

- Low flow rates allow water to be absorbed as needed. Reduces runoff
- Flow will not fluctuate at pressures between 20 and 90 psi (1.4 to 6.2 bar)
- Flow is not adjustable for increased vandal resistance
- Shipped with special SR-050 1/2" (15/21) bubbler filter screen for easy installation and resistance to debris
- Trickle pattern on models 1401 and 1402; umbrella pattern on models 1404 and 1408
- Five-year trade warranty



1400 Series

Operating Range

- Flow: 0.25 to 2.00 gpm (1.2 to 7.2 l/m)
- Spacing: 1 to 3 feet (0.3 to 0.9 m)*
- Pressure: 20 to 90 psi (1.4 to 6.2 bar)

Models

- 1401: 0.25 gpm (0.06 m³/h; 0.9 l/m); full-circle, trickle pattern
- 1402: 0.50 gpm (0.11 m³/h; 1.8 l/m); full-circle, trickle pattern
- 1404: 1.00 gpm (0.23 m³/h; 3.6 l/m); full-circle, umbrella pattern
- 1408: 2.00 gpm (0.46 m³/h; 7.2 l/m); full-circle, umbrella pattern

* These ranges are based on proper pressure at nozzle. Rain Bird recommends using 1800/RD1800 PRS Spray Bodies to maintain optimum nozzle performance in higher pressure situations.

Pressure-Compensating Modules

Point-Source Medium-Flow Emitters for Watering Larger Shrubs and Trees



PCT-05, PCT-07, PCT-10

• 1/2" FPT inlet that easily threads onto a 1/2" PVC riser

Operating Range

- Flow: 5, 7, 10 gph (18.93, 26.50, 37.95 l/h)
- Pressure: 10 to 50 psi (0.7 to 3.5 bar)
- Required filtration: 100 mesh (150 micron)

Refer to page 122 for more information



Introduction

Spray Bodies

Spray & Rotary Nozzles

Rotors

Valves

Controllers

Sensors & Meters

Central Controls

Drip Irrigation

Pumps & Filtration

Drainage Products

Resources

Rotors

Major Products	Gear Driven Rotors				Impact Rotors	
Primary Applications	3500 Series	5000 Series	Falcon™ 6504 Series	8005 Series	2045A Maxi-Paw™ Series	XLR Water Jet Series
Turfgrass 15' to 35'	●	●				
Turfgrass 25' to 50'		●	●	●	●	
Turfgrass more than 50'			●	●		●
Residential	●	●			●	
Commercial	●	●	●	●	●	●
Vandalism/Damage Prone Areas				●		
Slopes	●	●	●	●	●	●
Ground Cover/Shrubs	●	●				
Athletic Fields			●	●		●
Pressure Regulating		●				
High Wind Areas	●	●	●	●	●	●
Taller Turfgrass		●		●		●
Non-Potable Water		●	●	●	●	●

Water Saving
\$
Water Saving Tips

- Rain Curtain™ nozzle technology is the standard in water-saving nozzle performance. Rain Curtain™ performance is available in all Rain Bird Rotors.
- 5000 Series Rotors with PRS reduce water waste from 15%-45%. By eliminating pressure variation and/or over pressurization, you'll save water and deliver greener results.
- All rotors with Seal-a-Matic™ (SAM) check valves prevent drainage from heads at lower elevations, stop water waste and eliminate landscape damage due to flooding and/or erosion.

3500 Series

Compact Residential Rotor. Big on Value and Convenience

Features

- Rain Curtain™ nozzles deliver even distribution over the entire radius including large wind resistant droplets and gentle close-in watering resulting in greener turf using less water
- Oversized wiper seal prevents leaks and protects internals from debris
- Arc adjustment through the top of the rotor requiring only a flat-blade screwdriver
- 3 year trade warranty

Options

- SAM Seal-A-Matic™ check valve holds up to 7 ft (2.1 m) of elevation change

Operating Specifications

- Precipitation rate: 0.37 to 0.83 inches per hour (9 to 21 mm/h)
- Radius: 15 to 35 feet (4.6 to 10.7 m)
- Radius may be reduced up to 25% with radius reduction screw
- Pressure: 25 to 55 psi (1.7 to 3.8 bar)
- Flow rate: 0.54 to 4.6 gpm (2.0 to 17.4 l/m)
- ½" NPT female bottom threaded inlet
- Reversing full- and part-circle adjustment 40° - 360°
- Nozzle trajectory of 25°

Models

- 3504-PC: 4" part/reverse full circle
- 3504-PC-SAM: 4" part/reverse full circle with SAM
- 3500-S-PC-SAM: 4" part/reverse full circle shrub model with SAM



3504-PC

 0.37 to 0.83 in/hr
(9 to 21 mm/h)

 25 to 55 psi
(1.7 to 3.8 bar)

 0.54 to 4.6 gpm
(2.0 to 17.4 l/m)
(0.12 to 1.04 m³/h)

 4" (10.2 cm)
Shrub: 7" (17.8 cm)
4": 6 5/8" (16.8 cm)
½" NPT



Superior Distribution Uniformity

The 3500 Series Rotors with Rain Curtain™ Technology are engineered to deliver a uniform spray pattern, giving you a consistently green lawn throughout.

3500 Series Rotors meet the requirements of the ASABE/ICC 802-2014 standard

The average DU(LQ) of the applicable products exceed 0.65 distribution uniformity.

Product	Type	Radius	DU(LQ)
3500	Rotors	15 - 35 ft.	> 0.75

To view the complete document of compliance for Rain Bird products that have been tested to meet the requirements of the ASABE/ICC 802-2014 standard and the California MWELQ go to: www.rainbird.com/agency/california/MWELQ.htm

How to Specify

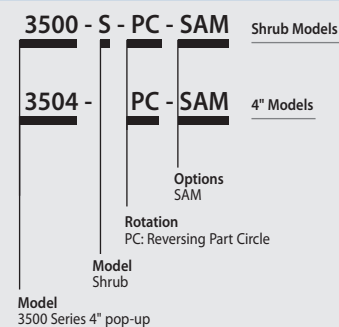

3504 Series Nozzle Performance					
Pressure psi	Nozzle	Radius ft.	Flow gpm	■ Precip In/h	▲ Precip In/h
25	0.75	15	0.54	0.46	0.53
	1.0	20	0.77	0.37	0.43
	1.5	23	1.06	0.39	0.45
	2.0	27	1.40	0.37	0.43
	3.0	29	2.17	0.50	0.57
	4.0	31	2.97	0.59	0.69
35	0.75	17	0.67	0.45	0.52
	1.0	21	0.92	0.40	0.46
	1.5	23	1.28	0.47	0.54
	2.0	27	1.69	0.45	0.52
	3.0	31	2.60	0.52	0.60
	4.0	33	3.58	0.63	0.73
45	0.75	17	0.77	0.51	0.59
	1.0	21	1.06	0.46	0.53
	1.5	24	1.48	0.49	0.57
	2.0	27	1.93	0.51	0.59
	3.0	31	3.00	0.60	0.69
	4.0	35	4.13	0.65	0.75
55	0.75	18	0.85	0.51	0.58
	1.0	22	1.18	0.47	0.54
	1.5	24	1.65	0.55	0.64
	2.0	28	2.15	0.53	0.61
	3.0	32	3.25	0.61	0.71
	4.0	35	4.60	0.72	0.83

3504 Series Nozzle Performance						METRIC
Pressure bar	Nozzle	Radius m	Flow m ³ /h	Flow l/m	■ Precip mm/h	▲ Precip mm/h
1.7	0.75	4.6	0.12	2.04	12	14
	1.0	6.1	0.17	2.91	9	11
	1.5	7.0	0.24	4.01	10	11
	2.0	8.2	0.32	5.30	9	11
	3.0	8.8	0.49	8.21	13	15
	4.0	9.4	0.67	11.24	15	17
2.0	0.75	4.8	0.13	2.24	12	13
	1.0	6.2	0.19	3.14	10	11
	1.5	7.0	0.26	4.35	11	12
	2.0	8.2	0.34	5.74	10	12
	3.0	9.1	0.53	8.87	13	15
	4.0	9.7	0.73	12.17	16	18
2.5	0.75	5.2	0.16	2.58	12	13
	1.0	6.4	0.21	3.55	10	12
	1.5	7.0	0.30	4.94	12	14
	2.0	8.2	0.39	6.51	12	13
	3.0	9.4	0.60	10.03	13	16
	4.0	10.1	0.83	13.82	16	19
3.0	0.75	5.2	0.17	2.86	13	15
	1.0	6.4	0.24	3.93	12	13
	1.5	7.3	0.33	5.49	12	14
	2.0	8.2	0.43	7.17	13	15
	3.0	9.4	0.67	11.13	15	17
	4.0	10.6	0.92	15.32	16	19
3.5	0.75	5.4	0.19	3.09	13	15
	1.0	6.6	0.26	4.27	12	14
	1.5	7.3	0.36	5.97	13	15
	2.0	8.4	0.47	7.79	13	15
	3.0	9.6	0.71	11.90	15	18
	4.0	10.7	1.00	16.66	18	20
3.8	0.75	5.5	0.19	3.22	13	15
	1.0	6.7	0.27	4.47	12	14
	1.5	7.3	0.37	6.25	14	16
	2.0	8.5	0.49	8.14	13	15
	3.0	9.8	0.74	12.30	16	18
	4.0	10.7	1.04	17.41	18	21

Precipitation rates based on half-circle operation

■ Square spacing based on 50% diameter of throw

▲ Triangular spacing based on 50% diameter of throw

Performance data collected in zero wind conditions

Performance data derived from tests that conform with ASABE Standards; ASABE S398.1.

See page 198 for complete ASABE Test Certification Statement.

Rotors

5000 Series

Engineered to be the Industry's Most Reliable and Best Performing Rotor

Features

- Oversized wiper seal prevents leaks and protects internals from debris
- Rain Curtain™ nozzles deliver even distribution over the entire radius including large wind resistant droplets and gentle close-in watering resulting in greener turf using less water
- A history of proven performance and reliability tested in millions of installations
- Self-flushing arc adjustment port that prevents buildup of debris
- 5 year trade warranty

Operating Specifications

- Precipitation rate: 0.20 to 1.50 in/hr (5 to 38 mm/h)
- Radius: 25 to 50 feet (7.6 to 15.2 m)
- Radius may be reduced up to 25% with radius reduction screw
- Pressure: 25 to 65 psi (1.7 to 4.5 bar)
- Flow Rate: 0.76 to 9.63 gpm (3.0 to 36.6 l/m; 0.17 to 2.19 m³/h)
- Reversing full- and part-circle adjustment from 40° - 360°
- Standard nozzle trajectory of 25°. Low angle nozzle trajectory of 10°. MPR nozzles varied nozzle trajectory between 12° - 25°.

Optional Features

- **Plus (+) Flow shutoff** – “The Green Top.” Reduce downtime on jobs by flushing and nozzling rotors without running back and forth to the controller or valves
- **PRS (R)** with flow optimizer technology. The 45 psi pressure regulator lowers water bills, provides exact flow of each rotor, equalizes lateral lines, and eliminates misting and fogging
- **SAM Seal-A-Matic™** check valve holds up to 7 feet (2.1 m) of elevation change
- **Stainless steel (SS) riser** helps deter vandalism on public turf areas (available on 4 and 6" models)
- **Purple cover (NP)** for non-potable systems



5000 Series

 0.20 to 1.50 in/hr
(5 to 37 mm/h)

 25 to 65 psi
(1.7 to 4.5 bar)

 0.76 to 9.63 gpm
(3.0 to 36.6 l/m)
(0.17 to 2.19 m³/h)

 Shrub: 4" (10.2 cm)
6" (15.2 cm)
12" (30.5 cm)
Shrub: 7 3/4" (19.7cm)
4": 7 3/8" (18.5 cm)
6": 9 5/8" (24.5 cm)
12": 16 7/8" (42.9 cm)
3/4" NPT

5000 Series Rotors meet the requirements of the ASABE/ICC 802-2014 standard

The average DU(LQ) of the applicable products exceed 0.65 distribution uniformity.

Product	Type	Radius	DU(LQ)
5000 Series	Rotors	25 - 50 ft.	> 0.70

To view the complete document of compliance for Rain Bird products that have been tested to meet the requirements of the ASABE/ICC 802-2014 standard and the California MWELO go to: www.rainbird.com/agency/california/MWELO.htm

How to Specify

5004+ - S-PC-SAM-R-NP-SS

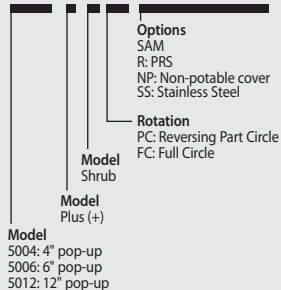

Note: Certain specifications not available for some rotor series.



S Shrub Model
+ Flow Shut-off

PC Part Circle & Reversing Full Circle
FC Non-Reversing Full Circle

SAM Check valve
R Pressure Regulation

SS Stainless Steel
NP Non-Potable Cover

5000 Series (cont.)

Models

Part-circle units (PC) are adjustable from 40° –360°.

Full-circle units (FC) are 360 degrees only.

- 5000SPCSAM: 5000S Shrub Part Circle SAM
- 5000+SPCSAM: 5000S Shrub Plus Part Circle SAM
- 5000+SPCSAMNP: 5000S Shrub Plus Part Circle SAM Non Potable
- 5000+SPCSAMR: 5000S Shrub Plus PRS Part Circle SAM
- 5000+SPCSAMRN: 5000S Shrub Plus PRS Part Circle SAM Non Potable
- 5004PC: 5004 Part Circle
- 5004PC20: 5004 Part Circle w/2.0 Nozzle
- 5004PC30: 5004 Part Circle w/3.0 Nozzle
- 5004PCSAM: 5004 Part Circle SAM
- 5004PCSAM20: 5004 Part Circle SAM w/2.0 Nozzle
- 5004PCNP: 5004 Part Circle Non Potable
- 5004PCR: 5004 Part Circle PRS
- 5004+PC: 5004 Plus Part Circle
- 5004+PC20: 5004 Plus Part Circle w/2.0 Nozzle
- 5004+PC30: 5004 Plus Part Circle w/3.0 Nozzle
- 5004+PCSAM: 5004 Plus Part Circle SAM
- 5004+PCR 5004: Plus Part Circle PRS
- 5004+PCSAMR: 5004 Plus Part Circle SAM PRS
- 5004+PCSAMR20: 5004 Plus Part Circle SAM PRS w/2.0 Nozzle
- 5004+PCSAMR30: 5004 Plus Part Circle SAM PRS w/3.0 Nozzle
- 5004+PCSAMRNP: 5004 Plus Part Circle SAM PRS Non Potable
- 5004+PCSAMRSS: 5004 Plus Part Circle SAM PRS Stainless Steel
- 5004+PCSAMRNS: 5004 Plus Part Circle SAM PRS Stainless Steel Non Potable
- 5004FC 5004: Full Circle
- 5004+FC 5004: Plus Full Circle
- 5004+FCSAM: 5004 Plus Full Circle SAM
- 5004+FCSAMR: 5004 Plus Full Circle SAM PRS

- 5004+FCSAMRSS: 5004 Plus Full Circle Stainless Steel SAM PRS
- 5006PC: 5006 Part Circle
- 5006PC30: 5006 Part Circle w/ 3.0 Nozzle
- 5006+PC: 5006 Plus Part Circle
- 5006+PCSAM: 5006 Plus Part Circle SAM
- 5006+PCSAMNP: 5006 Plus Part Circle SAM Non Potable
- 5006+PCSAMR: 5006 Plus Part Circle SAM PRS
- 5006+PCSAMRNP: 5006 Plus Part Circle SAM PRS Non Potable
- 5006+PCSAMRSS: 5006 Plus Part Circle SAM PRS Stainless Steel
- 5006+PCSAMRNS: 5006 Plus Part Circle SAM PRS Stainless Steel Non Potable
- 5012+PCSAMR: 5012 Plus Part Circle SAM PRS
- 5012+PCSAMRNP: 5012 Plus Part Circle SAM PRS Non Potable

5000 Series Std. Angle Rain Curtain™ Nozzle Performance

Pressure psi	Nozzle	Radius ft.	Flow gpm	■ Precip In/h	▲ Precip In/h
25	1.5	33	1.12	0.20	0.23
	2.0	35	1.50	0.24	0.27
	2.5	35	1.81	0.28	0.33
	3.0	36	2.26	0.34	0.39
	4.0	36	2.91	0.43	0.49
	5.0	37	3.72	0.52	0.60
	6.0	37	4.25	0.60	0.69
	8.0	33	5.90	1.26	1.50
35	1.5	34	1.35	0.22	0.26
	2.0	36	1.81	0.27	0.31
	2.5	37	2.17	0.31	0.35
	3.0	38	2.71	0.36	0.42
	4.0	40	3.50	0.42	0.49
	5.0	41	4.47	0.51	0.59
	6.0	43	5.23	0.54	0.63
	8.0	41	7.06	0.94	1.10
45	1.5	35	1.54	0.24	0.28
	2.0	37	2.07	0.29	0.34
	2.5	37	2.51	0.35	0.41
	3.0	39	3.09	0.37	0.43
	4.0	42	4.01	0.44	0.51
	5.0	43	5.09	0.48	0.56
	6.0	44	6.01	0.59	0.69
	8.0	44	8.03	0.92	1.06
55	1.5	35	1.71	0.27	0.31
	2.0	37	2.30	0.32	0.37
	2.5	37	2.76	0.39	0.45
	3.0	40	3.47	0.42	0.48
	4.0	42	4.44	0.48	0.56
	5.0	45	5.66	0.54	0.62
	6.0	50	6.63	0.51	0.59
	8.0	47	8.86	0.80	0.93
65	1.5	34	1.86	0.31	0.36
	2.0	35	2.52	0.40	0.46
	2.5	37	3.01	0.42	0.49
	3.0	40	3.78	0.45	0.53
	4.0	42	4.83	0.53	0.61
	5.0	45	6.16	0.59	0.68
	6.0	50	7.22	0.55	0.64
	8.0	48	9.63	0.84	0.97

5000 Series Std. Angle Rain Curtain™ Nozzle Performance METRIC

Pressure bar	Nozzle	Radius m	Flow m³/h	Flow l/m	■ Precip mm/h	▲ Precip mm/h
2.0	1.5	10.2	0.28	4.8	5	6
	2.0	10.8	0.36	6.0	6	7
	2.5	10.9	0.44	7.2	7	9
	3.0	11.2	0.55	9.0	9	10
	4.0	11.6	0.71	12.0	11	12
	5.0	12.1	0.91	15.0	13	15
	6.0	12.4	1.05	17.4	15	17
	8.0	11.8	1.45	24.0	32	37
2.5	1.5	10.4	0.31	5.4	6	7
	2.0	11.0	0.41	6.6	7	8
	2.5	11.3	0.50	8.4	8	9
	3.0	11.2	0.62	10.2	9	11
	4.0	12.3	0.81	13.2	11	13
	5.0	12.7	1.03	17.4	13	15
	6.0	13.2	1.21	20.4	14	16
	8.0	13.3	1.63	27.0	24	28
3.0	1.5	10.6	0.34	6.0	6	7
	2.0	11.2	0.45	7.8	7	8
	2.5	11.3	0.56	9.6	9	10
	3.0	12.1	0.69	11.4	9	11
	4.0	12.7	0.89	15.0	11	13
	5.0	13.5	1.13	18.6	12	14
	6.0	13.4	1.34	22.2	13	17
	8.0	13.4	1.79	30.0	23	27
3.5	1.5	10.7	0.37	6.0	7	8
	2.0	11.3	0.49	8.4	8	9
	2.5	11.3	0.60	10.2	9	11
	3.0	12.2	0.74	12.6	10	12
	4.0	12.8	0.97	16.2	12	14
	5.0	13.7	1.23	20.4	13	15
	6.0	14.2	1.45	24.0	13	15
	8.0	14.9	1.93	32.4	20	24
4.0	1.5	10.6	0.40	6.6	7	8
	2.0	11.1	0.52	9.0	8	10
	2.5	11.3	0.64	10.8	10	12
	3.0	12.2	0.80	13.2	11	12
	4.0	12.8	1.04	17.4	13	15
	5.0	13.7	1.32	22.2	14	16
	6.0	14.9	1.55	25.8	14	16
	8.0	15.2	2.06	34.2	21	25
4.5	1.5	10.4	0.42	7.2	8	9
	2.0	10.7	0.55	9.0	10	11
	2.5	11.3	0.68	11.4	11	12
	3.0	12.2	0.84	13.8	11	13
	4.0	12.8	1.10	18.0	13	15
	5.0	13.7	1.40	23.4	15	17
	6.0	14.6	1.64	28.2	15	18
	8.0	15.2	2.19	36.6	19	22

Precipitation rates based on half-circle operation

■ Square spacing based on 50% diameter of throw

▲ Triangular spacing based on 50% diameter of throw

Performance data collected in zero wind conditions

Performance data derived from tests that conform with ASABE Standards; ASABE S398.1.

See page 198 for complete ASABE Test Certification Statement.

5000 Series Low Angle Nozzle Performance					
Pressure psi	Nozzle	Radius ft.	Flow gpm	■ Precip In/h	▲ Precip In/h
25	1.0 LA	25	0.76	0.23	0.27
	1.5 LA	27	1.15	0.30	0.35
	2.0 LA	29	1.47	0.34	0.39
	3.0 LA	29	2.23	0.51	0.59
35	1.0 LA	28	0.92	0.23	0.26
	1.5 LA	30	1.38	0.30	0.34
	2.0 LA	31	1.77	0.35	0.41
	3.0 LA	33	2.68	0.47	0.55
45	1.0 LA	29	1.05	0.24	0.28
	1.5 LA	31	1.58	0.32	0.37
	2.0 LA	32	2.02	0.38	0.44
	3.0 LA	35	3.07	0.48	0.56
55	1.0 LA	29	1.17	0.27	0.31
	1.5 LA	31	1.76	0.35	0.41
	2.0 LA	33	2.24	0.40	0.46
	3.0 LA	36	3.41	0.51	0.58
65	1.0 LA	29	1.27	0.29	0.34
	1.5 LA	31	1.92	0.38	0.44
	2.0 LA	33	2.45	0.43	0.50
	3.0 LA	36	3.72	0.55	0.64

Precipitation rates based on half-circle operation

■ Square spacing based on 50% diameter of throw

▲ Triangular spacing based on 50% diameter of throw

Performance data collected in zero wind conditions

Performance data derived from tests that conform with ASABE Standards; ASABE S398.1.

See page 198 for complete ASABE Test Certification Statement.

5000 Series Low Angle Nozzle Performance						METRIC
Pressure bar	Nozzle	Radius m	Flow m ³ /h	Flow l/m	■ Precip mm/h	▲ Precip mm/h
1.7	1.0 LA	7.6	0.17	3.0	6	7
	1.5 LA	8.2	0.26	4.2	8	9
	2.0 LA	8.8	0.33	5.4	9	10
	3.0 LA	8.8	0.51	8.4	13	15
2.0	1.0 LA	8.0	0.18	3.0	6	6
	1.5 LA	8.6	0.28	4.8	8	9
	2.0 LA	9.1	0.36	6.0	9	10
	3.0 LA	9.3	0.55	9.0	13	15
2.5	1.0 LA	8.6	0.20	3.6	5	6
	1.5 LA	9.2	0.32	5.4	8	9
	2.0 LA	9.5	0.41	6.6	9	10
	3.0 LA	10.1	0.62	10.2	12	14
3.0	1.0 LA	8.8	0.22	3.6	6	7
	1.5 LA	9.4	0.35	6.0	8	9
	2.0 LA	9.7	0.45	7.8	10	11
	3.0 LA	10.6	0.68	11.4	12	14
3.5	1.0 LA	8.8	0.24	4.2	6	7
	1.5 LA	9.4	0.38	6.6	9	10
	2.0 LA	9.9	0.49	8.4	10	11
	3.0 LA	10.8	0.74	12.6	13	15
4.0	1.0 LA	8.8	0.26	4.2	7	8
	1.5 LA	9.4	0.41	6.6	9	11
	2.0 LA	10.1	0.52	9.0	10	12
	3.0 LA	11.0	0.80	13.2	13	15
4.5	1.0 LA	8.8	0.27	4.8	7	8
	1.5 LA	9.4	0.44	7.2	10	11
	2.0 LA	10.1	0.56	9.0	11	13
	3.0 LA	11.0	0.84	13.8	14	16

Tools

Holdup Tool with Bubble Level

Features

- Combination holdup tool/bubble level makes proper installation easier
- Works with 5000, Falcon® 6504, and 8005

Model

- HOLDUPTOOL



HOLDUPTOOL

Rotor Tool

Features

- Flat blade screwdriver and pull-up tool all in one
- Works with 3500, 5000, Falcon® 6504, and 8005

Model

- ROTORTOOL



ROTORTOOL

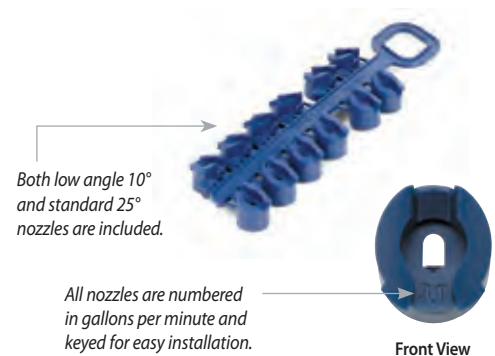

5000 PRS Std. Angle Rain Curtain™ Nozzle Performance					
Pressure psi	Nozzle	Radius ft.	Flow gpm	■ Precip In/h	▲ Precip In/h
25	1.5	33	1.12	0.2	0.23
	2.0	35	1.5	0.24	0.27
	2.5	35	1.81	0.28	0.33
	3.0	36	2.26	0.34	0.39
	4.0	36	2.91	0.43	0.49
	5.0	37	3.72	0.52	0.66
	6.0	37	4.25	0.60	0.69
	8.0	33	5.9	1.26	1.5
35	1.5	34	1.35	0.22	0.26
	2.0	36	1.81	0.27	0.31
	2.5	37	2.17	0.31	0.35
	3.0	38	2.71	0.36	0.41
	4.0	40	3.5	0.42	0.49
	5.0	41	4.47	0.51	0.59
	6.0	43	5.23	0.54	0.63
	8.0	41	7.06	0.94	1.1
45	1.5	35	1.54	0.24	0.28
	2.0	37	2.07	0.29	0.34
	2.5	37	2.51	0.35	0.41
	3.0	39	3.09	0.37	0.43
	4.0	42	4.01	0.44	0.51
	5.0	43	5.09	0.48	0.56
	6.0	44	6.01	0.55	0.63
	8.0	44	8.03	0.92	1.06
55 – 75	1.5	35	1.59	0.25	0.29
	2.0	37	2.14	0.3	0.35
	2.5	37	2.6	0.37	0.42
	3.0	39	3.2	0.39	0.44
	4.0	42	4.15	0.45	0.52
	5.0	43	5.27	0.5	0.58
	6.0	44	6.22	0.57	0.65
	8.0	44	8.31	0.72	0.84

5000 PRS Std. Angle Rain Curtain™ Nozzle Performance METRIC						
Pressure bar	Nozzle	Radius m	Flow m³/h	Flow l/m	■ Precip mm/h	▲ Precip mm/h
1.7	1.5	10.1	0.25	4.2	5	6
	2.0	10.7	0.34	5.4	6	7
	2.5	10.7	0.41	6.6	7	8
	3.0	11.0	0.51	8.4	8	10
	4.0	11.3	0.66	10.8	10	12
	5.0	11.9	0.84	13.8	12	14
	6.0	11.9	0.97	16.2	14	16
	8.0	11.0	1.34	22.2	22	26
2.0	1.5	10.2	0.28	4.8	5	6
	2.0	10.8	0.36	6.0	6	7
	2.5	10.9	0.44	7.2	7	9
	3.0	11.2	0.55	9.0	9	10
	4.0	11.6	0.71	12.0	11	12.6
	5.0	12.1	0.91	15.0	13	15
	6.0	12.4	1.05	17.4	15	17
	8.0	11.8	1.45	24.0	32	37
2.5	1.5	10.4	0.31	5.4	6	7
	2.0	11.0	0.41	6.6	7	8
	2.5	11.3	0.50	8.4	8	9
	3.0	11.2	0.62	10.2	9	11
	4.0	12.3	0.81	13.2	11	13
	5.0	12.7	1.03	17.4	13	15
	6.0	13.2	1.21	20.4	14	16
	8.0	13.3	1.63	27.0	24	18
3.0	1.5	10.6	0.34	6.0	6	7
	2.0	11.2	0.45	7.8	7	8
	2.5	11.3	0.56	9.6	9	10
	3.0	12.1	0.69	11.4	9	11
	4.0	12.7	0.89	16.8	11	13
	5.0	13.5	1.13	18.6	12	14
	6.0	13.9	1.34	22.2	14	16
	8.0	14.1	1.79	30.0	23	27
3.5 – 5.2	1.5	10.6	0.35	6.0	6	7
	2.0	11.2	0.47	7.8	8	9
	2.5	11.3	0.58	10.2	9	11
	3.0	12.1	0.71	12.0	10	11
	4.0	12.7	0.92	15.6	12	13
	5.0	13.5	1.17	19.2	13	15
	6.0	13.9	1.39	22.8	14	17
	8.0	14.1	1.85	31.2	18	21

Precipitation rates based on half-circle operation

■ Square spacing based on 50% diameter of throw

▲ Triangular spacing based on 50% diameter of throw

Performance data collected in zero wind conditions

Performance data derived from tests that conform with ASABE Standards; ASABE S398.1. See page 198 for complete ASABE Test Certification Statement.

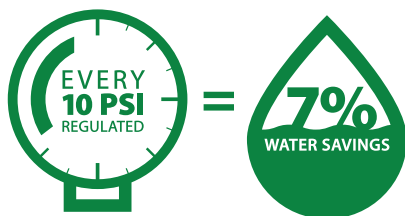

5000 PRS Low Angle Nozzle Performance					
Pressure psi	Nozzle	Radius ft.	Flow gpm	■ Precip In/h	▲ Precip In/h
25	1.0 LA	25	0.76	0.22	0.26
	1.5 LA	27	1.15	0.3	0.35
	2.0 LA	29	1.47	0.34	0.39
	3.0 LA	29	2.23	0.51	0.59
35	1.0 LA	28	0.92	0.21	0.25
	1.5 LA	30	1.38	0.3	0.34
	2.0 LA	31	1.77	0.35	0.41
	3.0 LA	33	2.68	0.47	0.55
45	1.0 LA	29	1.05	0.23	0.26
	1.5 LA	31	1.58	0.32	0.37
	2.0 LA	32	2.02	0.38	0.44
	3.0 LA	35	3.07	0.48	0.56
55 – 75	1.0 LA	29	1.09	0.25	0.29
	1.5 LA	31	1.64	0.33	0.38
	2.0 LA	32	2.09	0.39	0.45
	3.0 LA	35	3.18	0.5	0.58

Precipitation rates based on half-circle operation

■ Square spacing based on 50% diameter of throw

▲ Triangular spacing based on 50% diameter of throw

Performance data collected in zero wind conditions

Performance data derived from tests that conform with ASABE Standards; ASABE S398.1.

See page 198 for complete ASABE Test Certification Statement.

5000 PRS Low Angle Nozzle Performance						METRIC	
Pressure bar	Nozzle	Radius m	Flow m ³ /h	Flow l/m	■ Precip mm/h	▲ Precip mm/h	
1.7	1.0 LA	7.6	0.17	3.0	6	7	
	1.5 LA	8.2	0.26	4.2	8	9	
	2.0 LA	8.8	0.33	5.4	9	10	
	3.0 LA	8.8	0.51	8.4	13	15	
2.0	1.0 LA	8.0	0.18	3.0	6	6	
	1.5 LA	8.6	0.28	4.8	8	9	
	2.0 LA	9.1	0.36	6.0	9	10	
	3.0 LA	9.3	0.55	9.0	13	15	
2.5	1.0 LA	8.6	0.20	3.6	5	6	
	1.5 LA	9.2	0.32	5.4	8	9	
	2.0 LA	9.5	0.41	6.6	9	10	
	3.0 LA	10.1	0.62	10.2	12	14	
3.0	1.0 LA	8.8	0.22	3.6	6	7	
	1.5 LA	9.4	0.35	6.0	8	9	
	2.0 LA	9.7	0.45	7.8	10	11	
	3.0 LA	10.6	0.68	11.4	12	14	
3.5 – 5.2	1.0 LA	8.8	0.23	3.6	6	7	
	1.5 LA	9.4	0.36	6.0	8	10	
	2.0 LA	9.7	0.47	7.8	10	12	
	3.0 LA	10.6	0.70	12.0	13	15	

Flow Rate vs. Inlet Pressure – Rain Curtain™ Nozzles

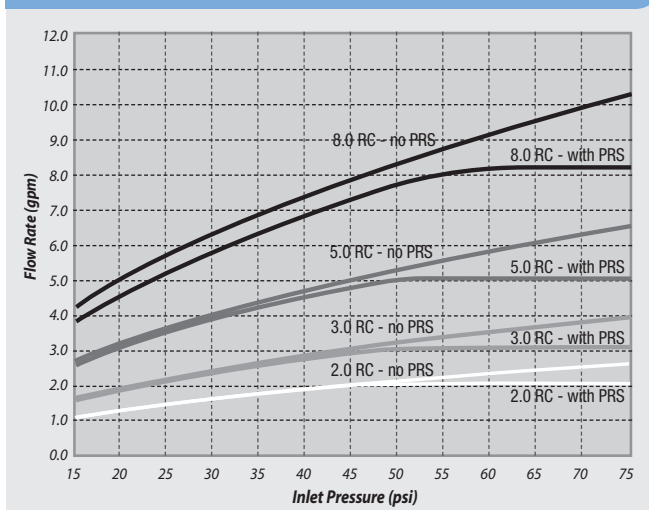

How much water can you save each minute using Rain Bird® 5000 PRS Rotors with Flow Optimizer Technology?

Flow GPM	45	50	55	60	65	70	75	80
6	0	0.33	0.66	0.96	1.25	1.54	1.81	2.06
8	0	0.43	0.85	1.24	1.62	1.98	2.33	2.67
10	0	0.55	1.07	1.57	2.05	2.52	2.96	3.39
12	0	0.66	1.27	1.86	2.43	2.97	3.50	4.01
14	0	0.77	1.49	2.18	2.84	3.48	4.10	4.70
16	0	0.87	1.69	2.48	3.24	3.97	4.67	5.35
18	0	0.98	1.90	2.79	3.64	4.46	5.25	6.01
20	0	1.10	2.12	3.10	4.05	4.96	5.83	6.68
22	0	1.21	2.33	3.42	4.46	5.47	6.44	7.37
24	0	1.30	2.54	3.72	4.85	5.94	7.00	8.01
26	0	1.41	2.76	4.04	5.27	6.45	7.60	8.70
28	0	1.53	2.96	4.34	5.66	6.93	8.16	9.35
30	0	1.63	3.17	4.65	6.07	7.43	8.74	10.02

Total gallons of water saved per minute of run time

Ex: At 70 psi a zone with 20 gpm of flow would save 4.96 gallons a minute with 5000 PRS

5000 Series MPR Nozzles

Perfectly Balanced Coverage with the 5000 Series Rotor

Features

- Rain Curtain™ nozzles deliver even distribution over the entire radius including large wind resistant droplets and gentle close-in watering resulting in greener turf using less water
- Precipitation rate is automatically matched with a uniform radius that does not require stream deflection
- Matched 0.6"/hour precipitation rates enable large and small turf areas to be zoned together by mixing rotors and Rain Bird R-VAN rotary nozzles

Models

- 5000MPRMPK: 5000/5000 Plus Series MPR nozzle tree multi pack- 25', 30', 35' radius in Quarter, Third, Half, Full arc



5000 Series MPR Nozzles



Installing Rotors with 5000 series MPR nozzles and Rain Bird R-VAN Rotary Nozzles in the same zone allows for matched precipitation from 8' to 35' (2.4m to 10.7m)

How to Specify

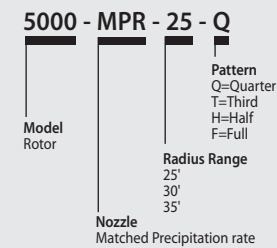

5000 MPR Nozzles meet the requirements of the ASABE/ICC 802-2014 standard

The average DU(LQ) of the applicable products exceed 0.65 distribution uniformity.

Product	Type	Radius	DU(LQ)
5000 MPR	Rotors	25 - 35 ft.	> 0.70

To view the complete document of compliance for Rain Bird products that have been tested to meet the requirements of the ASABE/ICC 802-2014 standard and the California MWELO go to: www.rainbird.com/agency/california/MWELO.htm





5000-MPR-25 (Red)





Nozzle	Pressure psi	Radius ft.	Flow gpm	Precip In/h	Precip In/h
Quarter	25	23	0.74	0.54	0.62
	35	24	0.88	0.59	0.68
	45	25	1.00	0.62	0.71
	55	25	1.11	0.68	0.79
	65	25	1.21	0.75	0.86
Third	25	23	1.00	0.55	0.63
	35	24	1.21	0.61	0.70
	45	25	1.38	0.64	0.74
	55	25	1.53	0.71	0.82
Half	25	23	1.44	0.52	0.61
	35	24	1.73	0.58	0.67
	45	25	1.98	0.61	0.70
	55	25	2.21	0.68	0.79
Full	25	23	2.78	0.51	0.58
	35	24	3.34	0.56	0.64
	45	25	3.82	0.59	0.68
	55	25	4.25	0.65	0.76
65	25	4.63	0.71	0.82	





5000-MPR-25 (Red)





METRIC

Nozzle	Pressure bar	Radius m	Flow m ³ /h	Flow l/m	Precip mm/h	Precip mm/h
Quarter	1.7	7.0	0.17	3.0	13.7	15.8
	2.4	7.3	0.20	3.6	14.9	17.3
	3.1	7.6	0.23	3.6	15.6	18.1
	3.8	7.6	0.25	4.2	17.4	20.1
	4.5	7.6	0.27	4.8	18.9	21.9
Third	1.7	7.0	0.23	3.6	13.9	16.0
	2.4	7.3	0.27	4.8	15.4	17.8
	3.1	7.6	0.31	5.4	16.2	18.7
	3.8	7.6	0.35	6.0	18.0	20.7
Half	1.7	7.0	0.33	5.4	13.3	15.4
	2.4	7.3	0.39	6.6	14.7	17.0
	3.1	7.6	0.45	7.2	15.5	17.9
	3.8	7.6	0.50	8.4	17.3	20.0
Full	1.7	7.0	0.63	10.8	12.8	14.8
	2.4	7.3	0.76	12.6	14.2	16.4
	3.1	7.6	0.87	14.4	14.9	17.3
	3.8	7.6	0.97	16.2	16.6	19.2
4.5	7.6	1.05	17.4	18.1	20.9	

5000-MPR-30 (Green)					
Nozzle	Pressure psi	Radius ft.	Flow gpm	Precip In/h	Precip In/h
Quarter 	25	29	1.03	0.47	0.54
	35	30	1.23	0.53	0.61
	45	30	1.40	0.60	0.69
	55	30	1.56	0.67	0.77
	65	30	1.69	0.72	0.83
Third 	25	29	1.34	0.46	0.53
	35	30	1.62	0.52	0.60
	45	30	1.85	0.59	0.69
	55	30	2.06	0.66	0.76
	65	30	2.24	0.72	0.83
Half 	25	29	2.15	0.49	0.57
	35	30	2.59	0.55	0.64
	45	30	2.96	0.63	0.73
	55	30	3.30	0.71	0.82
	65	30	3.60	0.77	0.89
Full 	25	29	4.24	0.49	0.56
	35	30	5.08	0.54	0.63
	45	30	5.78	0.62	0.71
	55	30	6.39	0.68	0.79
	65	30	6.92	0.74	0.85

5000-MPR-30 (Green)						METRIC
Nozzle	Pressure bar	Radius m	Flow m ³ /h	Flow l/m	Precip mm/h	Precip mm/h
Quarter 	1.7	8.8	0.23	3.6	12.0	13.8
	2.4	9.1	0.28	4.8	13.4	15.4
	3.1	9.1	0.32	5.4	15.2	17.6
	3.8	9.1	0.35	6.0	17.0	19.6
	4.5	9.1	0.38	6.6	18.4	21.2
Third 	1.7	8.8	0.30	4.8	11.7	13.5
	2.4	9.1	0.37	6.0	13.2	15.2
	3.1	9.1	0.42	7.2	15.1	17.4
	3.8	9.1	0.47	7.8	16.8	19.4
	4.5	9.1	0.51	8.4	18.3	21.1
Half 	1.7	8.8	0.49	8.4	12.5	14.4
	2.4	9.1	0.59	9.6	14.1	16.2
	3.1	9.1	0.67	11.4	16.1	18.6
	3.8	9.1	0.75	12.6	17.9	20.7
	4.5	9.1	0.82	13.8	19.6	22.6
Full 	1.7	8.8	0.96	16.2	12.3	14.2
	2.4	9.1	1.15	19.2	13.8	15.9
	3.1	9.1	1.31	21.6	15.7	18.1
	3.8	9.1	1.45	24.0	17.4	20.0
	4.5	9.1	1.57	26.4	18.8	21.7

5000-MPR-35 (Beige)					
Nozzle	Pressure psi	Radius ft.	Flow gpm	Precip In/h	Precip In/h
Quarter 	25	32	1.40	0.53	0.61
	35	34	1.67	0.56	0.64
	45	35	1.92	0.60	0.70
	55	35	2.13	0.67	0.77
	65	35	2.31	0.73	0.84
Third 	25	32	1.77	0.50	0.58
	35	34	2.15	0.54	0.62
	45	35	2.46	0.58	0.67
	55	35	2.74	0.65	0.75
	65	35	2.99	0.70	0.81
Half 	25	32	2.75	0.52	0.60
	35	34	3.33	0.55	0.64
	45	35	3.81	0.60	0.69
	55	35	4.23	0.66	0.77
	65	35	4.62	0.73	0.84
Full 	25	32	5.36	0.50	0.58
	35	34	6.62	0.55	0.64
	45	35	7.58	0.60	0.69
	55	35	8.43	0.66	0.76
	65	35	9.18	0.72	0.83

5000-MPR-35 (Beige)						METRIC
Nozzle	Pressure bar	Radius m	Flow m ³ /h	Flow l/m	Precip mm/h	Precip mm/h
Quarter 	1.7	9.8	0.32	5.4	13.4	15.4
	2.4	10.4	0.38	6.6	14.1	16.3
	3.1	10.7	0.44	7.2	15.3	17.7
	3.8	10.7	0.48	7.8	17.0	19.6
	4.5	10.7	0.52	9.0	18.4	21.3
Third 	1.7	9.8	0.40	6.6	12.7	14.6
	2.4	10.4	0.49	8.4	13.6	15.8
	3.1	10.7	0.56	9.6	14.7	17.0
	3.8	10.7	0.62	10.2	16.4	18.9
	4.5	10.7	0.68	11.4	17.9	20.7
Half 	1.7	9.8	0.62	10.2	13.1	15.2
	2.4	10.4	0.76	12.6	14.1	16.3
	3.1	10.7	0.87	14.4	15.2	17.6
	3.8	10.7	0.96	16.2	16.9	19.5
	4.5	10.7	1.05	17.4	18.4	21.3
Full 	1.7	9.8	1.22	20.4	12.8	14.8
	2.4	10.4	1.50	25.2	14.0	16.2
	3.1	10.7	1.72	28.8	15.1	17.5
	3.8	10.7	1.91	31.8	16.8	19.4
	4.5	10.7	2.09	34.8	18.3	21.2

■ Square spacing based on 50% diameter of throw
 ▲ Triangular spacing based on 50% diameter of throw
 Performance data collected in zero wind conditions

Performance data derived from tests that conform with ASABE Standards; ASABE S398.1.
 See page 186 for complete ASABE Test Certification Statement.

Falcon® 6504 Series

Reliable and Economical

Features

- Ratcheting stem just like standard spray bodies
- 3-port, color-coded Rain Curtain nozzles for optimal long range, mid-range, and close-in watering
- SAM Seal-A-Matic check valve
- Heavy-duty, stainless steel retract spring ensures positive pop-down
- 5 year warranty

Options

- **Stainless steel (SS)** riser helps deter vandalism on public turf areas
- **Purple cover (NP)** for non-potable systems

Operating Specifications

- Reversing full- and part-circle adjustment from 40-360°
- Precipitation rate: 0.37 to 1.26 inches per hour (9 to 33 mm/h)
- Radius: 37 to 65 feet (11.3 to 19.8 m)
- Pressure: 30 to 90 psi (2.1 to 6.2 bar)
- Flow: 2.9 to 21.7 gpm (0.66 to 4.93 m³/h; 10.8 to 82.2 l/m)
- 1" female NPT or BSP threaded inlet
- SAM Seal-A-Matic™ check valve holds up to 10 feet (3.1 m) of elevation change
- Rain Curtain™ Nozzles: Included with rotor, other sizes available upon request; 10-grey, 12-beige, 14-light green, 16-dark brown, 18-dark blue
- Nozzle outlet trajectory is 25°

Models

- 6504-FC: Full-circle
- 6504-PC: Part-circle
- 6504-FC-NP: Full-circle, non-potable cover
- 6504-PC-NP: Part-circle, non-potable cover
- 6504-FC-SS: Full-circle, stainless steel
- 6504-PC-SS: Part-circle, stainless steel
- 6504-FC-SS-NP: Full-circle, stainless steel, non-potable cover
- 6504-PC-SS-NP: Part-circle, stainless steel, non-potable cover

Note: BSP thread versions available for most models



Falcon® 6504 Series

- 0.37 to 1.31 in/hr (9 - 33 mm/h)
- 30 to 90 psi (2.1 to 6.2 bar)
- 2.9 to 21.7 gpm (10.8 to 82.2 l/m) (0.66 to 4.93 m³/h)
- 4" (10.2 cm)
- 8½" (21.6 cm)
- 1" NPT or BSP

How to Specify

6504 - PC - SS - NP

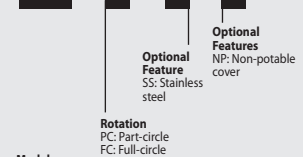

Model
6504: Falcon

Note: For non-U.S. applications, it is necessary to specify NPT or BSP thread type.



Falcon 6504 Series Rotors meet the requirements of the ASABE/ICC 802-2014 standard

The average DU(LQ) of the applicable products exceed 0.65 distribution uniformity.

Product	Type	Radius	DU(LQ)
6504 Series	Rotors	39 - 65 ft.	> 0.80

To view the complete document of compliance for Rain Bird products that have been tested to meet the requirements of the ASABE/ICC 802-2014 standard and the California MWELQ go to: www.rainbird.com/agency/california/MWELQ.htm

Falcon® 6504 Nozzle Performance					
Pressure psi	Nozzle	Radius ft.	Flow gpm	■ Precip In/h	▲ Precip In/h
30	● 4	39	2.9	0.37	0.42
	● 6	43	4.2	0.44	0.50
40	● 4	41	3.3	0.38	0.44
	● 6	45	4.9	0.47	0.54
	● 8	49	6.6	0.53	0.61
	● 10	51	8.1	0.60	0.69
	● 12	53	9.7	0.66	0.77
	● 14	55	11.3	0.72	0.83
	● 16	55	12.6	0.80	0.93
	● 18	59	13.7	0.76	0.87
50	● 4	41	3.7	0.42	0.49
	● 6	47	5.5	0.44	0.51
	● 8	51	7.4	0.55	0.63
	● 10	53	9.1	0.62	0.72
	● 12	55	11.0	0.70	0.81
	● 14	59	12.7	0.70	0.81
	● 16	61	14.3	0.74	0.85
	● 18	59	15.4	0.85	0.98
60	● 4	41	4.0	0.46	0.53
	● 6	47	6.0	0.52	0.60
	● 8	51	8.2	0.61	0.70
	● 10	55	10.0	0.64	0.73
	● 12	57	12.2	0.72	0.83
	● 14	61	14.0	0.72	0.84
	● 16	63	15.7	0.76	0.88
	● 18	63	17.1	0.83	0.96
70	● 4	41	4.4	0.50	0.58
	● 6	49	6.3	0.51	0.58
	● 8	51	8.9	0.66	0.76
	● 10	57	10.8	0.64	0.74
	● 12	59	13.2	0.73	0.84
	● 14	61	15.2	0.79	0.91
	● 16	63	16.9	0.82	0.95
	● 18	65	18.3	0.83	0.96
80	● 4	43	4.6	0.48	0.55
	● 6	49	6.9	0.55	0.64
	● 8	53	9.4	0.64	0.74
	● 10	55	11.6	0.74	0.85
	● 12	61	14.0	0.72	0.84
	● 14	61	16.2	0.84	0.97
	● 16	63	18.1	0.88	1.01
	● 18	65	19.6	0.89	1.03
90	● 18	65	21.7	0.99	1.14

Precipitation rates based on half-circle operation
 ■ Square spacing based on 50% diameter of throw
 ▲ Triangular spacing based on 50% diameter of throw



Falcon 6504
Cutaway

Rotors

Falcon® 6504 Nozzle Performance						METRIC	
Pressure bar	Nozzle	Radius m	Flow m³/h	Flow l/m	■ Precip mm/h	▲ Precip mm/h	
2.1	● 4	11.9	0.66	10.98	9	11	
	● 6	13.1	0.95	15.90	11	13	
2.5	● 4	12.3	0.72	11.92	10	11	
	● 6	13.5	1.05	17.56	12	13	
	● 8	14.9	1.50	25.20	13	16	
	● 10	15.5	1.84	30.60	15	18	
	● 12	16.2	2.20	36.60	17	19	
	● 14	16.8	2.57	42.60	18	21	
	● 16	16.8	2.86	47.40	20	24	
	● 18	18.0	3.11	51.60	19	22	
3.0	● 4	12.5	0.78	13.02	10	12	
	● 6	14.1	1.16	19.34	12	13	
	● 8	15.1	1.56	26.04	14	16	
	● 10	15.8	1.92	31.99	15	18	
	● 12	16.4	2.31	38.44	17	20	
	● 14	17.2	2.68	44.63	18	21	
	● 16	17.4	3.00	49.95	20	23	
	● 18	18.0	3.25	54.11	20	23	
3.5	● 4	12.5	0.85	14.09	11	13	
	● 6	14.9	1.26	20.96	11	13	
	● 8	15.5	1.69	28.24	14	16	
	● 10	16.2	2.08	34.70	16	18	
	● 12	16.8	2.52	41.98	18	21	
	● 14	18.0	2.91	48.45	18	21	
	● 16	18.6	3.27	54.53	19	22	
	● 18	18.1	3.53	58.78	22	25	
4.0	● 4	12.5	0.89	14.91	11	13	
	● 6	14.4	1.34	22.33	13	15	
	● 8	15.5	1.83	30.44	15	17	
	● 10	16.6	2.23	37.17	16	19	
	● 12	17.3	2.72	45.28	18	21	
	● 14	18.5	3.12	52.01	18	21	
	● 16	19.1	3.50	58.37	19	22	
	● 18	19.0	3.81	63.45	21	24	

Pressure bar	Nozzle	Radius m	Flow m³/h	Flow l/m	■ Precip mm/h	▲ Precip mm/h
4.5	● 4	12.5	0.96	15.94	12	14
	● 6	14.6	1.40	23.33	13	15
	● 8	15.5	1.95	32.43	16	19
	● 10	17.1	2.37	39.44	16	19
	● 12	17.7	2.89	48.17	18	21
	● 14	18.6	3.32	55.38	19	22
	● 16	19.2	3.71	61.82	20	23
	● 18	19.5	4.03	67.12	21	24
5.0	● 4	12.7	1.01	16.84	13	15
	● 6	14.9	1.47	24.50	13	15
	● 8	15.7	2.05	34.16	17	19
	● 10	17.2	2.50	41.64	17	19
	● 12	18.1	3.04	50.72	19	21
	● 14	18.6	3.51	58.49	20	23
	● 16	19.2	3.91	65.11	21	24
	● 18	19.8	4.23	70.51	22	25
5.5	● 4	13.1	1.04	17.39	12	14
	● 6	14.9	1.56	25.79	14	16
	● 8	16.1	2.13	35.54	16	19
	● 10	16.8	2.63	43.84	19	22
	● 12	18.6	3.18	52.92	18	21
	● 14	18.6	3.67	61.23	21	25
	● 16	19.2	4.10	68.40	22	26
	● 18	19.8	4.44	74.07	23	26
6.0	● 18	19.8	4.79	79.77	24	28
6.2	● 18	19.8	4.93	82.13	25	29

Precipitation rates based on half-circle operation

■ Square spacing based on 50% diameter of throw

▲ Triangular spacing based on 50% diameter of throw

Performance data collected in zero wind conditions

Performance data derived from tests that conform with ASABE Standards; ASABE S398.1. See page 198 for complete ASABE Test Certification Statement.

Low Flow Kit - B81610



4

6

8

Standard Flow Kit - B81620



10

12

14

16

18

Falcon® 6504 Rain Curtain™ Nozzles

8005 Series

Protect Your Turf with High Performance, Vandal and Abuse Resistant Rotors from 39' to 81'

Features

- Vandal resistance, brass reinforced turret for increased side impact durability
- Memory Arc® returns the rotor to its original arc setting
- Non-strippable drive mechanism prevents damage from vandals
- Easy, wet, dry arc adjustment with slotted screwdriver through top of rotor from 50° to 330° part-circle, 360° non-reversing full-circle. Full and part circle operation in one unit
- Left and right side trips adjustable for ease of installation without turning the case and loosening the pipe connection
- SAM Seal-A-Matic check valve
- 3-port, color-coded Rain Curtain nozzles for optimal long-range, mid-range, and close-in watering
- 5 year warranty

Options

- **Stainless steel (SS)** riser helps deter vandalism on public turf areas
- **Purple cover (NP)** for non-potable systems
- Optional Sod Cup

Operating Specifications

- Radius: 39 to 81 feet (11.9 to 24.7 m)
- Precipitation rate: 0.48 to 1.23 inches per hour (12 to 31 mm/h)
- Pressure: 50 to 100 psi (3.5 to 6.9 bar)
- Flow: 3.8 to 36.3 gpm (0.86 to 8.24 m³/h; 14.4 to 137.4 l/m)
- 1" NPT or BSP female threaded inlet
- SAM Seal-A-Matic™ check valve holds up to 10 feet (3.1 m) of elevation change
- Nozzle outlet trajectory is 25°
- Rain Curtain™ Nozzles: Included with rotor, other sizes available upon request; 10-grey, 12-beige, 14-light green, 16-dark brown, 18-dark blue

Models

- 8005: 1" NPT female threaded inlet
- 8005-NP: 1" NPT female threaded inlet; non-potable cover
- 8005-SS: 1" NPT female threaded inlet; stainless steel
- 8005-NP-SS: 1" NPT female threaded inlet; stainless steel and non-potable cover

Note: BSP threads versions available for most models

**** Note:** Pop-up height is measured from cover to the primary nozzle port. Overall body height is measured popped down

8005 Series Rotors meet the requirements of the ASABE/ICC 802-2014 standard

The average DU(LQ) of the applicable products exceed 0.65 distribution uniformity.

Product	Type	Radius	DU(LQ)
8005 Series	Rotors	39 - 81 ft.	> 0.75

To view the complete document of compliance for Rain Bird products that have been tested to meet the requirements of the ASABE/ICC 802-2014 standard and the California MWELD go to: www.rainbird.com/agency/california/MWELD.htm



8005 Series

 0.48 to 1.28 in/hr
(12 - 32 mm/h)

 50 to 100 psi
(3.5 to 6.9 bar)

 3.8 to 36.3 gpm
(14.4 to 137.4 l/m)
(0.86 to 8.24 m³/h)

 5" (12.7 cm)
10 1/8" (25.7 cm)
1" NPT or BSP

How to Specify

8005 - NP - SS - 16

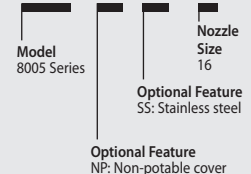

Note: For non-U.S. applications, it is necessary to specify NPT or BSP thread type.



8005 Nozzle Performance

Pressure psi	Nozzle	Radius ft.	Flow gpm	Precip In/h	Precip In/h
50	● 04	39	3.8	0.48	0.56
	● 06	45	5.6	0.53	0.62
	● 08	49	6.6	0.53	0.61
	● 10	53	9.3	0.64	0.74
	● 12	57	11.1	0.66	0.76
	● 14	59	12.6	0.70	0.81
	● 16	61	14.3	0.74	0.85
	● 18	63	16.1	0.78	0.90
	● 20	65	18.6	0.85	0.98
	● 22	65	20.7	0.94	1.09
60	● 24	63	22.3	1.08	1.25
	○ 26	65	24.3	1.11	1.28
	● 04	39	3.8	0.48	0.56
	● 06	45	6.1	0.58	0.67
	● 08	49	8.4	0.67	0.78
	● 10	53	10.1	0.69	0.80
	● 12	59	12.0	0.66	0.77
	● 14	61	14.3	0.74	0.85
	● 16	65	15.9	0.72	0.84
	● 18	65	17.8	0.81	0.94
70	● 20	67	20.1	0.86	1.00
	● 22	71	23.2	0.89	1.02
	● 24	69	24.7	1.00	1.15
	○ 26	73	26.7	0.96	1.11
	● 04	39	4.7	0.60	0.69
	● 06	45	6.7	0.64	0.74
	● 08	49	9.0	0.72	0.83
	● 10	55	11.1	0.71	0.82
	● 12	59	13.2	0.73	0.84
	● 14	63	15.3	0.74	0.86
80	● 16	67	17.2	0.74	0.85
	● 18	67	19.3	0.83	0.96
	● 20	71	22.0	0.84	0.97
	● 22	73	25.2	0.91	1.05
	● 24	75	27.0	0.92	1.07
	○ 26	75	29.4	1.01	1.16
	● 04	39	5.0	0.63	0.73
	● 06	45	7.1	0.68	0.78
	● 08	49	9.8	0.79	0.91
	● 10	55	11.8	0.75	0.87
● 12	61	14.2	0.73	0.85	
90	● 14	63	16.4	0.80	0.92
	● 16	67	18.6	0.80	0.92
	● 18	69	20.9	0.85	0.98
	● 20	71	23.9	0.91	1.05
	● 22	75	27.3	0.93	1.08
	● 24	77	29.2	0.95	1.10
	○ 26	79	31.5	0.97	1.12

Pressure psi	Nozzle	Radius ft.	Flow gpm	Precip In/h	Precip In/h
90	● 12	61	14.7	0.76	0.88
	● 14	65	17.9	0.82	0.94
	● 16	69	20.0	0.81	0.93
	● 18	71	22.2	0.85	0.98
	● 20	73	25.3	0.91	1.06
	● 22	75	29.1	1.00	1.15
	● 24	79	31.0	0.96	1.10
100	○ 26	79	33.7	1.04	1.20
	● 20	75	26.8	0.85	0.97
	● 22	77	30.7	1.00	1.15
	● 24	79	32.8	1.01	1.17
	○ 26	81	36.3	1.07	1.23

Precipitation rates based on half-circle operation

■ Square spacing based on 50% diameter of throw

▲ Triangular spacing based on 50% diameter of throw

Performance data collected in zero wind conditions

Performance data derived from tests that conform with ASABE Standards; ASABE S398.1. See page 186 for complete ASABE Test Certification Statement.



Sod Cup for 8005

8005 Nozzle Performance						METRIC	
Pressure bar	Nozzle	Radius m	Flow m ³ /h	Flow l/m	■ Precip mm/h	▲ Precip mm/h	
3.5	● 4	11.9	0.86	14.38	12	14	
	● 6	13.7	1.28	21.34	14	16	
	● 8	14.9	1.59	25.50	14	16	
	● 10	16.1	2.10	35.43	16	19	
	● 12	17.5	2.52	42.27	16	19	
	● 14	18.0	2.89	48.18	18	21	
	● 16	18.7	3.28	54.59	19	22	
	● 18	19.2	3.69	61.43	20	23	
	● 20	19.9	4.25	70.83	21	25	
	● 22	20.0	5.08	79.07	25	29	
4.0	● 4	11.9	0.93	14.38	13	15	
	● 6	13.7	1.37	22.71	15	17	
	● 8	14.9	1.75	30.44	16	18	
	● 10	16.3	2.30	37.63	17	20	
	● 12	17.7	2.70	44.74	17	20	
	● 14	18.5	3.17	52.85	19	21	
	● 16	19.6	3.54	58.98	18	21	
	● 18	19.7	3.97	66.10	20	24	
	● 20	20.3	4.50	74.95	22	25	
	● 22	21.3	5.23	85.94	23	27	
4.5	● 4	11.9	1.00	16.18	14	16	
	● 6	13.7	1.45	24.28	15	18	
	● 8	14.9	1.92	32.99	17	20	
	● 10	16.5	2.40	40.22	18	20	
	● 12	18.0	2.87	47.81	18	20	
	● 14	18.9	3.37	56.12	19	22	
	● 16	20.1	3.77	62.77	19	22	
	● 18	20.1	4.22	70.36	21	24	
	● 20	21.1	4.79	79.87	22	25	
	● 22	22.0	5.51	91.80	23	26	
5.0	● 4	11.9	1.06	18.08	15	17	
	● 6	13.7	1.54	25.74	16	19	
	● 8	14.9	2.09	34.83	19	22	
	● 10	16.7	2.50	42.68	18	21	
	● 12	18.3	3.05	50.92	18	21	
	● 14	19.2	3.54	58.96	19	22	
	● 16	20.4	3.99	66.44	19	22	
	● 18	20.6	4.47	74.58	21	24	
	● 20	21.6	5.11	85.08	22	25	
	● 22	22.4	5.84	97.39	23	27	
5.5	● 4	11.9	1.13	18.90	16	18	
	● 6	13.7	1.62	26.84	17	20	
	● 8	14.9	2.25	37.02	20	23	
	● 10	16.8	2.70	44.60	19	22	
	● 12	18.5	3.23	53.66	19	22	
	● 14	19.2	3.72	61.98	20	23	
	● 16	20.4	4.22	70.28	20	23	
	● 18	21.0	4.74	78.97	21	25	
	● 20	21.6	5.42	90.30	23	27	
	● 22	22.8	6.19	103.15	24	28	
6.0	● 4	11.9	1.13	18.90	16	18	
	● 6	13.7	1.62	26.84	17	20	
	● 8	14.9	2.25	37.02	20	23	
	● 10	16.8	2.70	44.60	19	22	
	● 12	18.5	3.23	53.66	19	22	
	● 14	19.2	3.72	61.98	20	23	
	● 16	20.4	4.22	70.28	20	23	
	● 18	21.0	4.74	78.97	21	25	
	● 20	21.6	5.42	90.30	23	27	
	● 22	22.8	6.19	103.15	24	28	
6.2	● 4	11.9	1.13	18.90	16	18	
	● 6	13.7	1.62	26.84	17	20	
	● 8	14.9	2.25	37.02	20	23	
	● 10	16.8	2.70	44.60	19	22	
	● 12	18.5	3.23	53.66	19	22	
	● 14	19.2	3.72	61.98	20	23	
	● 16	20.4	4.22	70.28	20	23	
	● 18	21.0	4.74	78.97	21	25	
	● 20	21.6	5.42	90.30	23	27	
	● 22	22.8	6.19	103.15	24	28	
6.5	● 4	11.9	1.13	18.90	16	18	
	● 6	13.7	1.62	26.84	17	20	
	● 8	14.9	2.25	37.02	20	23	
	● 10	16.8	2.70	44.60	19	22	
	● 12	18.5	3.23	53.66	19	22	
	● 14	19.2	3.72	61.98	20	23	
	● 16	20.4	4.22	70.28	20	23	
	● 18	21.0	4.74	78.97	21	25	
	● 20	21.6	5.42	90.30	23	27	
	● 22	22.8	6.19	103.15	24	28	
6.9	● 4	11.9	1.13	18.90	16	18	
	● 6	13.7	1.62	26.84	17	20	
	● 8	14.9	2.25	37.02	20	23	
	● 10	16.8	2.70	44.60	19	22	
	● 12	18.5	3.23	53.66	19	22	
	● 14	19.2	3.72	61.98	20	23	
	● 16	20.4	4.22	70.28	20	23	
	● 18	21.0	4.74	78.97	21	25	
	● 20	21.6	5.42	90.30	23	27	
	● 22	22.8	6.19	103.15	24	28	

8005 Nozzle Performance						METRIC	
Pressure bar	Nozzle	Radius m	Flow m ³ /h	Flow l/m	■ Precip mm/h	▲ Precip mm/h	
5.5	● 4	11.9	1.13	18.90	16	18	
	● 6	13.7	1.62	26.84	17	20	
	● 8	14.9	2.25	37.02	20	23	
	● 10	16.8	2.70	44.60	19	22	
	● 12	18.5	3.23	53.66	19	22	
	● 14	19.2	3.72	61.98	20	23	
	● 16	20.4	4.22	70.28	20	23	
	● 18	21.0	4.74	78.97	21	25	
	● 20	21.6	5.42	90.30	23	27	
	● 22	22.8	6.19	103.15	24	28	
6.0	● 4	11.9	1.13	18.90	16	18	
	● 6	13.7	1.62	26.84	17	20	
	● 8	14.9	2.25	37.02	20	23	
	● 10	16.8	2.70	44.60	19	22	
	● 12	18.5	3.23	53.66	19	22	
	● 14	19.2	3.72	61.98	20	23	
	● 16	20.4	4.22	70.28	20	23	
	● 18	21.0	4.74	78.97	21	25	
	● 20	21.6	5.42	90.30	23	27	
	● 22	22.8	6.19	103.15	24	28	
6.2	● 4	11.9	1.13	18.90	16	18	
	● 6	13.7	1.62	26.84	17	20	
	● 8	14.9	2.25	37.02	20	23	
	● 10	16.8	2.70	44.60	19	22	
	● 12	18.5	3.23	53.66	19	22	
	● 14	19.2	3.72	61.98	20	23	
	● 16	20.4	4.22	70.28	20	23	
	● 18	21.0	4.74	78.97	21	25	
	● 20	21.6	5.42	90.30	23	27	
	● 22	22.8	6.19	103.15	24	28	
6.5	● 4	11.9	1.13	18.90	16	18	
	● 6	13.7	1.62	26.84	17	20	
	● 8	14.9	2.25	37.02	20	23	
	● 10	16.8	2.70	44.60	19	22	
	● 12	18.5	3.23	53.66	19	22	
	● 14	19.2	3.72	61.98	20	23	
	● 16	20.4	4.22	70.28	20	23	
	● 18	21.0	4.74	78.97	21	25	
	● 20	21.6	5.42	90.30	23	27	
	● 22	22.8	6.19	103.15	24	28	
6.9	● 4	11.9	1.13	18.90	16	18	
	● 6	13.7	1.62	26.84	17	20	
	● 8	14.9	2.25	37.02	20	23	
	● 10	16.8	2.70	44.60	19	22	
	● 12	18.5	3.23	53.66	19	22	
	● 14	19.2	3.72	61.98	20	23	
	● 16	20.4	4.22	70.28	20	23	
	● 18	21.0	4.74	78.97	21	25	
	● 20	21.6	5.42	90.30	23	27	
	● 22	22.8	6.19	103.15	24	28	

Precipitation rates based on half-circle operation
 ■ Square spacing based on 50% diameter of throw
 ▲ Triangular spacing based on 50% diameter of throw
 Performance data collected in zero wind conditions

Performance data derived from tests that conform with ASABE Standards; ASABE S398.1.
 See page 198 for complete ASABE Test Certification Statement.



Falcon® 6504 Rain Curtain™ Nozzles

2045A Maxi-Paw™ and 2045-PJ Maxi-Bird™

Dirty Water Applications - Spacing Up to 45 Feet (13.7 m)

Features

- Proven impact drive with straight-through flow for superior performance in dirty water
- Five standard trajectory and two low angle (LA) color-coded nozzles for matched precipitation and in a wide range of applications
- 360° full-circle OR arc adjustable from 20° to 340°
- Side and combination ½" or ¾" bottom inlet for design flexibility (Maxi-Paw)
- 3 year warranty

Operating Specifications

- Precipitation rate: 0.28 to 1.21 inches per hour (7 to 31 mm/h)
- Spacing: 22 to 45 feet (6.7 to 13.7 m)
- Flow rate: 1.5 to 8.4 gpm (0.34 to 1.91 m³/h; 0.09 to 0.53 l/s)
- Radius: 22 to 45 feet (6.7 to 13.7 m); 18 feet (5.4 m) with Radius Reduction Screw
- Pressure: 25 to 60 psi (1.7 to 4.1 bar)
- Combination ½" or ¾" female bottom inlet (Maxi-Paw)
- ½" FPT side inlet (Maxi-Paw)
- ½" NPT Riser-Mounted (Maxi-Bird)

Models

- 2045A Maxi-Paw
- 2045A Maxi-Paw-SAM
- 2045A Maxi-Paw-SAM-NP
- 42064: Maxi-Paw Wrench - for removing internal assembly from case
- 2045-PJ Maxi-Bird



2045A Maxi-Paw



2045-PJ Maxi-Bird



42064-Maxi-Paw Wrench

How to Specify

2045A- SAM-10- LA

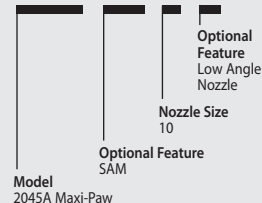

Maxi-Paw and Maxi-Bird Nozzle Performance					
Pressure psi	Nozzle	Radius ft.	Flow gpm	Precip In/h	Precip In/h
25	● 06	-	-	-	-
	● 07 LA	22	1.5	0.60	0.69
	● 07	32	2.2	0.41	0.48
	● 08	35	2.8	0.44	0.51
	● 10 LA	25	3.4	1.05	1.21
	● 10	38	4.2	0.56	0.65
35	● 12	39	5.5	0.70	0.80
	● 06	37	2.0	0.28	0.32
	● 07 LA	23	1.9	0.69	0.80
	● 07	37	2.7	0.38	0.44
	● 08	38	3.3	0.44	0.51
	● 10 LA	29	4.0	0.92	1.06
45	● 10	41	4.8	0.55	0.64
	● 12	42	6.3	0.69	0.79
	● 06	38	2.3	0.31	0.35
	● 07 LA	25	2.1	0.65	0.75
	● 07	39	3.0	0.38	0.44
	● 08	40	3.7	0.45	0.51
55	● 10 LA	31	4.5	0.90	1.04
	● 10	42	5.4	0.59	0.68
	● 12	44	7.1	0.71	0.82
	● 06	38	2.5	0.33	0.39
	● 07 LA	25	2.3	0.71	0.82
	● 07	41	3.3	0.38	0.44
60	● 08	41	4.1	0.47	0.54
	● 10 LA	32	5.0	0.94	1.09
	● 10	43	6.0	0.62	0.72
	● 12	45	7.9	0.75	0.87
	● 06	38	2.6	0.35	0.40
	● 07 LA	25	2.4	0.74	0.85
60	● 07	41	3.5	0.40	0.46
	● 08	42	4.2	0.46	0.53
	● 10 LA	32	5.4	1.02	1.17
	● 10	44	6.4	0.64	0.74
	● 12	45	8.4	0.80	0.92

LA = Low Angle

Precipitation rates based on half-circle operation

■ Square spacing based on 50% diameter of throw

▲ Triangular spacing based on 50% diameter of throw

Maxi-Paw and Maxi-Bird Nozzle Performance						METRIC
Pressure bar	Nozzle	Radius m	Flow m³/h	Flow l/m	Precip mm/h	Precip mm/h
2.0	● 6	-	-	-	-	-
	● 07 LA	6.8	0.38	6.0	16	19
	● 7	10.4	0.55	9.0	10	12
	● 8	11.0	0.68	11.4	11	13
	● 10 LA	8.1	0.83	13.8	25	29
	● 10	11.9	1.01	16.8	14	16
2.5	● 12	12.3	1.32	22.2	18	20
	● 6	11.3	0.46	7.8	7	8
	● 07 LA	7.1	0.44	7.2	17	20
	● 7	11.4	0.62	10.2	10	11
	● 8	11.7	0.76	12.6	11	13
	● 10 LA	8.9	0.92	15.6	23	27
3.0	● 10	12.5	1.11	18.6	14	16
	● 12	12.9	1.45	24.0	18	20
	● 6	11.5	0.51	8.4	8	9
	● 07 LA	7.5	0.47	7.8	17	19
	● 7	11.8	0.67	11.4	10	11
	● 8	12.1	0.83	13.8	11	13
3.5	● 10 LA	9.4	1.01	16.8	23	27
	● 10	12.8	1.21	20.4	15	17
	● 12	13.3	1.59	26.4	18	21
	● 6	11.6	0.55	9.0	8	9
	● 07 LA	7.6	0.50	8.4	17	20
	● 7	12.2	0.72	12.0	10	11
4.0	● 8	12.4	0.89	15.0	12	13
	● 10 LA	9.6	1.09	18.0	23	27
	● 10	13.0	1.30	21.6	15	18
	● 12	13.6	1.72	28.8	19	21
	● 6	11.6	0.58	9.6	9	10
	● 07 LA	7.6	0.54	9.0	18	21
4.0	● 7	12.5	0.78	13.2	10	11
	● 8	12.7	0.94	15.6	12	14
	● 10 LA	9.8	1.19	19.8	25	29
	● 10	13.3	1.42	23.4	16	19
	● 12	13.7	1.86	31.2	20	23

Performance data collected in zero wind conditions

Performance data derived from tests that conform with ASABE Standards; ASABE S398.1. See page 198 for complete ASABE Test Certification Statement.



2045A Maxi-Paw and 2045-PJ Standard Angle Nozzles



2045A Maxi-Paw and 2045-PJ Low Angle Nozzles

XLR Series Water Jets

The World's Most Advanced Long-Range Rotor

Features

- Constant speed independent of operating pressure and flow rate
- Water deflector distributes water uniformly for entire throw distance
- Barrel and nozzle design optimized to maximize throw
- Nozzle is 54% larger than competition
- Innovative material selection maximize efficiency of movement
- Full- and part-circle (20-340°) in one unit
- Adjustable trajectory model provides ultimate in adaptability
- 5 nozzle options (sold separately)
- Only 2 field serviceable components – built to last reliably
- One-year trade warranty

Operating Specifications

- Radius: 81 to 202 feet (25 - 62 m)
- Pressure: 30 to 120 psi (2.1 to 8.3 bar)
- Flow: 35 to 379 gpm (7.9 to 86.1 m³/h)
- Inlet: 2" NPT, 2" BSP or 2" flange
- Nozzle trajectory: 24° fixed, 44° fixed or adjustable (15° to 45°)
- Nozzles (sold separately):
 - 0.47 (12 mm)
 - 0.63 (16 mm)
 - 0.79 (20 mm)
 - 0.94 (24 mm)
 - 1.10 (28 mm)

Options

- Optional Jet-Breaker for improved distribution uniformity
- Inlet adapter kits available in flange, NPT and BSP configurations to convert existing inlet

Models

- IXLR24: 24° fixed trajectory with flange inlet
- IXLR44: 44° fixed trajectory with flange inlet
- IXLRADJ: Adjustable trajectory (15-45°) with flange inlet
- XLR24NPT: 24° fixed trajectory with NPT inlet
- XLRADJNPT: Adjustable trajectory (15-45°) with NPT inlet
- XLR24BSP: 24° fixed trajectory with BSP inlet
- XLRADJBSP: Adjustable trajectory (15-45°) with BSP inlet

Low pressure water distribution profile

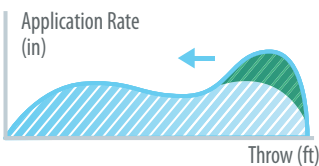

Improved distribution uniformity with Dynamic Jet-Breaker in low pressure condition and Solid-Set systems

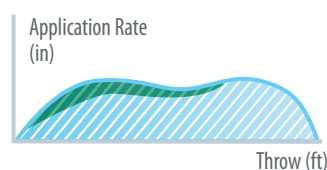

XLR24



XLR44



XLRADJ

How to Specify

XLR	44	- NPT -	XLRJETKIT
			Optional Feature* XLRJETKIT: Jet Breaker Kit
		Mounting	
		NPT	
		BSP	
		Blank: Flange	
		Model	
		24: 24°	
		44: 44°	
		ADJ: Adjustable	
Model			
XLR			

*Order Separately



XLR 24 Nozzle Throw Range Fixed 24° Trajectory										
Pressure psi	0.47"		0.63"		0.79"		0.94"		1.10"	
	Flow gpm	Radius ft.	Flow gpm	Radius ft.	Flow gpm	Radius ft.	Flow gpm	Radius ft.	Flow gpm	Radius ft.
30	35	81	62	96	97	99	139	102	189	104
40	40	93	71	107	112	120	161	125	219	130
50	45	103	80	117	125	133	180	141	245	151
60	50	109	87	124	137	141	197	152	268	166
70	54	113	94	129	148	147	212	160	289	176
80	57	118	101	135	158	153	227	167	309	185
90	61	122	107	141	168	158	241	174	328	193
100	64	125	113	145	177	163	254	180	346	198
110	67	128	118	148	186	166	266	184	363	202

XLR 24 Nozzle Throw Range Fixed 24° Trajectory											METRIC
Pressure bar	12 mm		16 mm		20 mm		24 mm		28 mm		
	Flow m³/h	Radius m	Flow m³/h	Radius m	Flow m³/h	Radius m	Flow m³/h	Radius m	Flow m³/h	Radius m	
2.0	7.8	24.2	13.8	28.9	21.7	29.4	31.1	30.2	42.3	30.9	
2.5	8.7	26.8	15.4	31.3	24.2	33.8	34.7	35.1	47.3	36.5	
3.0	9.6	29.4	16.9	33.7	26.5	38.2	38.0	39.9	51.8	42.1	
3.5	10.3	31.2	18.2	35.5	28.7	40.4	41.1	42.9	56.0	45.9	
4.0	11.1	32.9	19.5	37.3	30.7	42.5	43.9	45.8	59.8	49.7	
4.5	11.7	33.9	20.7	38.6	32.5	43.9	46.6	47.6	63.5	52.0	
5.0	12.4	34.8	21.8	39.8	34.3	45.2	49.1	49.3	66.9	54.3	
5.5	13.0	35.7	22.9	41.1	35.9	46.5	51.5	50.9	70.2	56.2	
6.0	13.5	36.6	23.9	42.4	37.5	47.7	53.8	52.5	73.3	58.1	
6.5	14.1	37.4	24.9	43.3	39.1	48.7	56.0	53.7	76.3	59.3	
7.0	14.6	38.2	25.8	44.2	40.6	49.7	58.1	54.9	79.2	60.6	



XLR 44 Nozzle Throw Range / Fixed 44° Trajectory															
Pressure psi	0.47"			0.63"			0.79"			0.94"			1.10"		
	Flow gpm	Radius ft.	Height ft.	Flow gpm	Radius ft.	Height ft.	Flow gpm	Radius ft.	Height ft.	Flow gpm	Radius ft.	Height ft.	Flow gpm	Radius ft.	Height ft.
40	40	82	37	71	98	38	112	113	39	161	121	40	219	128	41
50	45	91	43	80	108	45	125	125	47	180	135	48	245	144	50
60	50	97	48	87	116	51	137	135	54	197	146	56	268	157	58
70	54	102	51	94	122	55	148	142	59	212	154	62	289	165	66
80	57	107	54	101	127	59	158	148	64	227	160	68	309	172	72
90	61	110	56	107	132	62	168	153	68	241	165	72	328	177	77
100	64	113	58	113	135	65	177	157	71	254	169	76	346	182	82
110	67	115	60	118	137	66	186	160	73	266	172	79	363	185	85
120	70	116	61	124	139	68	194	161	75	278	175	81	379	188	87

XLR 44 Nozzle Throw Range / Fixed 44° Trajectory															METRIC	
Pressure bar	12 mm			16 mm			20 mm			24 mm			28 mm			
	Flow m³/h	Radius m	Height m	Flow m³/h	Radius m	Height m	Flow m³/h	Radius m	Height m	Flow m³/h	Radius m	Height m	Flow m³/h	Radius m	Height m	
3.0	9.6	26.1	11.9	16.9	31.0	12.3	26.5	35.9	12.7	38.0	38.5	13.1	51.8	41.0	13.4	
3.5	10.3	27.7	13.1	18.2	33.0	13.7	28.7	38.2	14.4	41.1	41.1	14.9	56.0	44.0	15.3	
4.0	11.1	29.3	14.3	19.5	34.9	15.1	30.7	40.6	16.0	43.9	43.8	16.6	59.8	47.1	17.3	
4.5	11.7	30.4	15.1	20.7	36.3	16.1	32.5	42.2	17.2	46.6	45.6	18.1	63.5	49.0	18.9	
5.0	12.4	31.5	15.9	21.8	37.7	17.1	34.3	43.9	18.4	49.1	47.4	19.5	66.9	51.0	20.5	
5.5	13.0	32.4	16.4	22.9	38.7	17.9	35.9	45.1	19.4	51.5	48.7	20.6	70.2	52.3	21.8	
6.0	13.5	33.3	17.0	23.9	39.8	18.7	37.5	46.3	20.3	53.8	50.0	21.7	73.3	53.6	23.0	
6.5	14.1	33.9	17.4	24.9	40.5	19.2	39.1	47.1	21.0	56.0	50.9	22.5	76.3	54.6	24.1	
7.0	14.6	34.5	17.9	25.8	41.2	19.8	40.6	48.0	21.7	58.1	51.8	23.4	79.2	55.6	25.1	
7.5	15.1	34.8	18.1	26.7	41.7	20.2	42.0	48.5	22.2	60.1	52.4	24.0	82.0	56.3	25.8	
8.0	15.6	35.2	18.4	27.6	42.1	20.6	43.4	49.0	22.7	62.1	53.0	24.6	84.6	57.0	26.4	

The performance data were obtained under ideal testing conditions and may be adversely affected by wind and other factors. Pressure refers to pressure at nozzle. A lowered trajectory angle improves the irrigation efficiency in windy conditions. For every 3° drop of the trajectory angle the throw is reduced by approx. 3 to 4% Radius = radius of throw in feet. Nozzle at 5 feet above ground level. Height = maximum stream height in meters above nozzle.

XLR ADJ Nozzle Throw Range | Adjustable Trajectory

- For every 3° drop of the trajectory angle, the throw is reduced by approximately 3 to 4%.
- Use the XLR 24 Nozzle Throw Range Table for your pressure and nozzle diameter.

TSJ/TSJ-PRS Series

Swing Joints Connect ¾" (1.9 cm) and 1" (2.5 cm) Rotors or Quick Coupler Valves to Lateral Pipes

Features

- Preassembled units save the contractor time and reduce installation costs
- Excellent structural integrity from the swept elbow design reduces the costs associated with fatigue related failures
- Double O Ring provides extra protection against leaks and keeps threads clean of debris making hand tightening easy
- The TSJ-PRS combines the great flow characteristics of the Rain Bird turf swing joint with an inline pressure regulating outlet elbow for controlling and maintaining constant pressure right at the rotor inlet

Operating Specifications

- Pressure rating: 315 psi at 73° F (21.7 bar at 22.8° C) (per ASTM D3139)
- ¾" joint pressure loss: 0.3 psi at 6 gpm (0.02 bar at 0.4 l/s)
- 1" joint pressure loss: 1.5 psi at 18 gpm; 2.5 psi at 23 gpm (0.1 bar at 1,1 l/s; 0.2 bar at 1.5 l/s)
- TSJ-PRS maximum flow: 22 gpm (1.41 l/s)

TSJ-PRS Application Information

- The TSJ-PRS is not recommended for use in systems where the pressure in the lateral lines is equal to or less than the nominal regulation pressure, as the increased pressure drop may adversely affect the performance of such systems
- To reduce the effects of water hammer, Rain Bird recommends flow rates in the supply line not exceed 5 ft/sec (1.5 m/s). The TSJ-PRS is not intended to function as a water hammer prevention device
- There are no user-serviceable parts inside. The internal spring is under compression. Do not open the PRS unit under any circumstances

Models

- TSJ-12075: 12" (30.5 cm) long, ¾" M NPT x M NPT swing joint
- TSJ-12: 12" (30.5 cm) long, 1" M NPT x M NPT swing joint
- TSJ-100-PRS: 1" swing joint with 70 psi pressure regulator, 12" (30.5 cm) long, 1" M NPT x M NPT inlet and outlet



TSJ-12075, TSJ-12

TSJ-100-PRS

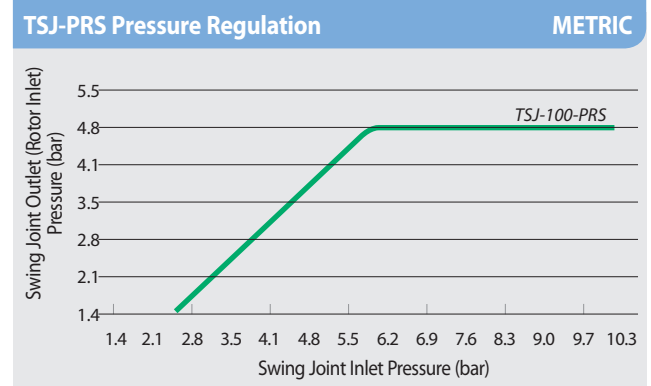
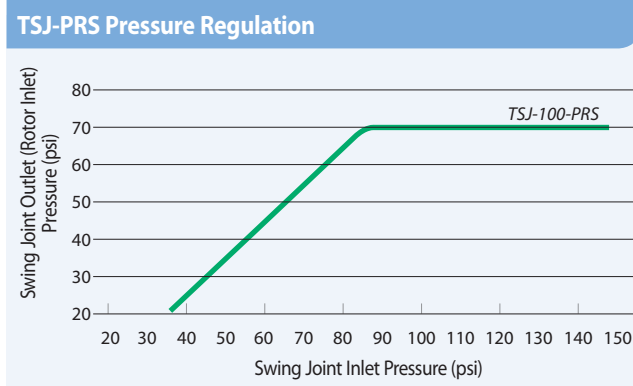



Valves

Major Products									
Primary Applications	HV	HVF	DV	DVF	ASVF	PGA	PEB/PESB/PESB-R	EFB-CP/BPES	QC
Manual Bleed	I/E	I/E	I/E	I/E	I/E	I	I/E	I/E	
Flow Control		•		•	•	•	•	•	
Bottom Inlet			DV-A		•	•		BPES	•
Low Flow	•	•	•	•	•		•	•	
PRS-Dial Compatible						•	•	•	
Dirty Water							•	•	
Non-Potable Water						•	•	•	•
Sites Requiring Brass								•	•
Sites Requiring Plastic	•	•	•	•	•	•	•		
Decoder System Compatible						•	•	•	

• DV/DVF available in globe, angle, slip x slip, and male x barb configurations. • Flows below 3 gpm (0.68 m³/h; 0.19 l/s) install 200 mesh filter upstream. • I/E = Internal/External
 • The PESB-R and EFB-CP are specifically designed with chlorine-resistant components for reclaimed water applications.



Water Saving Tips

- The PRS-Dial is an excellent means of regulating outlet pressure at the valve regardless of incoming pressure fluctuations. It helps ensure optimal pressure performance at the head.
- Rain Bird valves provide excellent filtration characteristics for maximum reliability in a wide range of environments.
- PESB-R and EFB-CP reclaimed valves provide reliable operation in all water conditions. Valve diaphragms are composed of EPDM, a rubber material which is chlorine and chemical resistant.

DV / DVF Series

Diaphragm Valve – The Industry Leader for Over 25 Years

Features

- Double-filtered (diaphragm and solenoid) pilot-flow design for maximum reliability and grit resistance
- Buna-N, balanced pressure diaphragm with self-cleaning 90 mesh (200 micron) pilot water filter and captive spring
- Energy-efficient, low-power encapsulated solenoid with captured plunger and 90-mesh (200 micron) solenoid filter
- Unique, easy-to-turn pressure assisted flow control mechanism (DVF models only)
- External bleed to manually flush system of dirt and debris during installation and system start-up
- Internal bleed for spray-free manual operation
- Accepts Rain Bird TBOS latching solenoid for use with most battery-operated controllers
- Operates in low-flow and Landscape Drip applications when a 200 mesh filter is installed upstream
- **Not recommended for use with two-wire control systems**

Specifications

- Pressure: 15 to 150 psi (1,0 to 10,4 bar)
- 075-DV Non-Flow Control Model: 0.2 to 22 GPM (0,05 to 5,0 m³/h; 0,01 to 1,39 l/s). For flows below 3 GPM (0,68 m³/h; 0,19 l/s) or any Landscape Drip application, use a 200 mesh filter installed upstream
- 100-DV Non-Flow Control Model: 0.2 to 40 gpm (0,05 to 9,085 m³/h; 0,01 to 2,52 l/s). For flows below 3 gpm (0,68 m³/h; 0,19 l/s) or any Landscape Drip application, use a 200 mesh filter installed upstream
- 100-DVF Flow Control Model: 0.2 to 40 gpm (0,05 to 9,085 m³/h; 0,01 to 2,52 l/s); For flows below 3 gpm (0,68 m³/h; 0,19 l/s) or any Landscape Drip application, use a 200 mesh filter installed upstream
- Water Temperature: Up to 110° F (43° C)
- Ambient air temperature: Up to 125° F (52° C)
- 24 VAC 50/60 Hz (cycles per second) solenoid power requirement: 0.450A inrush current; 0.250A holding current
- Solenoid coil resistance: 38 Ohms



075-DV



100-DV-MB



100-DV-A



100-DVF

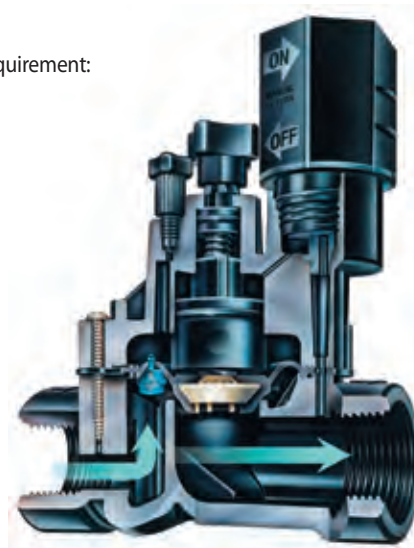

DVF Cutaway

How to Specify

100 - DV - MB

Optional Configuration:
MB: Male x Barb
A: Angle
SS: Slip x Slip

Model

DV: Remote Control Valve
DVF: Remote Control Valve with Flow Control

Size

075: 3/4"
100: 1"

*This specifies a 100-DV valve; 1" (26/34) male x barb.
Note: For non-U.S. applications it is necessary to specify NPT or BSP thread type (1" only).*

DV / DVF Series (cont.)

Dimensions

DV Valves

- Height: 4½" (11.4 cm)
- Height (Angle): 5½" (14 cm)
- Length: 4¾" (11.1 cm)
- Length (Angle): 3¾" (9.5 cm)
- Length (MB): 5¾" (14.6 cm)
- Width: 3½" (8.4 cm)

DVF Valves

- Height: 5¾" (14.2 cm)
- Length: 4¾" (11.1 cm)
- Length (MB): 5¾" (14.6 cm)
- Width: 3½" (8.4 cm)

Models

- 075-DV: ¾" NPT
- 100-DV: 1" NPT female x female*
- 100-DV-SS: 1" slip x slip
- 100-DV-A: 1" NPT female x female
- 100-DV-MB: 1" male x barb
- 100-DVF: 1" NPT female x female*
- 100-DVF-SS: 1" slip x slip
- 100-DVF-MB: 1" male x barb

* Available with BSP threads

Recommendations

1. Rain Bird recommends flow rates that result in discharge velocities in the supply line not to exceed 7.5 ft/sec (2.3 m/s) in order to reduce the effects of water hammer.
2. Rain Bird residential valves cannot be used with PRS pressure regulating modules.
3. **Not recommended for use with two-wire systems.**

DV and DVF Valve Pressure Loss (psi)		
Flow gpm	075-DV ¾" psi	100-DV/100-DVF 1" psi
1	3.2	3.3
3	3.9	3.6
5	4.2	3.8
10	5.0	3.8
20	7.7	5.1
30	-	6.4
40	-	8.6

DV and DVF Valve Pressure Loss (bar)			METRIC
Flow m³/h	l/m	075-DV ¾" bar	100-DV/100-DVF 1" bar
0.23	4	0.22	0.23
0.60	10	0.26	0.24
1.20	20	0.29	0.26
3.60	60	0.45	0.32
4.50	75	0.53	0.35
6.00	100	-	0.41
9.00	150	-	0.59

100-DV Angle, MxB Valve Pressure Loss (psi)		
Flow gpm	075-DV ¾" psi	100-DV/100-DVF 1" psi
1	2.8	2.5
3	3.0	2.9
5	3.2	3.0
10	3.9	3.1
20	4.3	4.3
30	5.4	7.4
40	8.2	12.7

100-DV Angle, MxB Valve Pressure Loss (bar)			METRIC
Flow m³/h	l/m	075-DV ¾" bar	100-DV/100-DVF 1" bar
0.23	4	0.19	0.17
0.60	10	0.20	0.19
1.20	20	0.22	0.21
3.60	60	0.28	0.26
4.50	75	0.30	0.30
6.00	100	0.35	0.44
9.00	150	0.56	0.86

Note: DV/DVF Male x barb not recommended for flows exceeding 30 gpm (6.81 m³/h, 113.56 l/m)

ASVF Series

Anti-siphon Valve with Flow Control – The Industry Leader for Over 20 Years

Features

- Combination of the reliable DVF Angle valve and atmospheric backflow preventer in one unit
- Incorporates all features of DV/DVF Series valves
- **Not recommended for use with two-wire control systems**

Specifications

- Pressure: 15 to 150 psi (1,0 to 10,4 bar)
- 075-ASVF Flow: 0.2 to 22 GPM (0,05 to 5,0 m³/h; 0,01 to 1,39 l/s). For flows below 3 GPM (0,68 m³/h; 0,19 l/s) or any Landscape Drip products application, use a 200 mesh filter installed upstream
- 100-ASVF Flow: 0.2 to 40 GPM (0,05 to 9,085 m³/h; 0,01 to 2,52 l/s). For flows below 3 GPM (0,68 m³/h; 0,19 l/s) or any Landscape Drip products application, use a 200 mesh filter installed upstream
- Water temperature: Up to 110° F (43° C)
- Ambient air temperature: Up to 125° F (52° C)
- 24 VAC 50/60 Hz (cycles per second) solenoid power requirement: 0.450A inrush current; 0.250A holding current
- Solenoid coil resistance: 38 Ohms

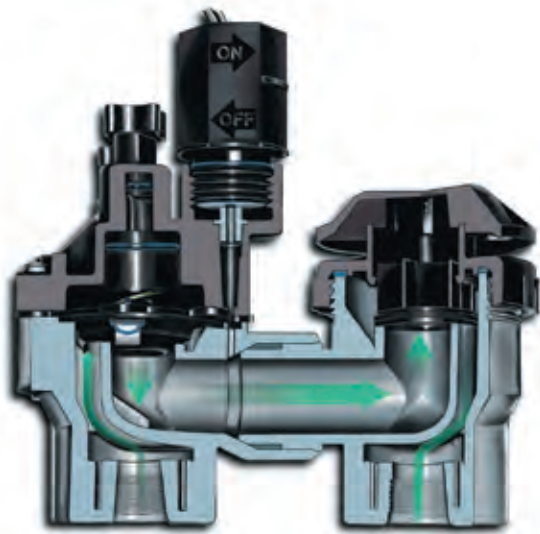

ASVF Cutaway

Installation Notes

- Anti-siphon valve must be installed upright
- Anti-siphon unit must be installed at least 6" (15,2 cm) above the highest point of water in the pipe and sprinklers it serves
- No valve can be located downstream of the anti-siphon valve
- Anti-siphon valves must not be subjected to operating pressure for more than twelve (12) hours in any twenty-four (24) hour period
- Uniform Plumbing Code Table 603.2 Consult local codes

Dimensions

- Height: 6 1/4" (15.8 cm)
- Length: 6 1/10" (15.5 cm)
- Width: 3 1/5" (8.1 cm)

Models

- 075-ASVF: 3/4"
- 100-ASVF: 1"

Models available in NPT threads only

Recommendations

1. Rain Bird recommends flow rates that result in discharge velocities in the supply line not to exceed 7.5 ft/sec (2.3 m/s) in order to reduce the effects of water hammer.
2. Rain Bird residential valves cannot be used with PRS pressure regulating modules.
3. **Not recommended for use with two-wire systems.**



100-ASVF

ASVF Valve Pressure Loss (psi)

Flow gpm	075-ASVF 3/4" psi	100-ASVF 1" psi
1	2.8	2.9
3	3.4	3.1
5	3.8	3.3
10	4.6	3.9
20	6.5	5.0
30	-	7.8
40	-	13.4

ASVF Valve Pressure Loss (bar)

Flow m ³ /h	METRIC		
	l/m	075-ASVF 3/4" bar	100-ASVF 1" bar
0.23	3.8	0.19	0.20
0.6	10	0.23	0.21
1.2	20	0.26	0.23
3.6	60	0.39	0.31
4.5	75	0.45	0.34
6.0	100	-	0.47
9.0	150	-	0.91

* Rain Bird recommends flow rates in the supply line not to exceed 7.5 ft/sec (2.3 m/s) in order to reduce the effects of water hammer

HV Series

High Value Valve. High Performance. Big Savings.

Features

- Patented, eccentric, balanced pressure, Buna-N diaphragm with self-cleaning 90-mesh (200 micron) pilot water filter and captured stainless steel spring – Eccentric design provides smoother closing, less water hammer
- Only four durable, captured multi-drive bonnet screws that come out with half the number of turns for fast and easy servicing – at least twice as fast as the competition
- Glass-filled polypropylene body for strength (slip by slip model bodies are PVC)
- All popular model configurations available
- Compact design, 2.54" spin radius for tight installations
- Reverse flow, normally closed design
- External bleed to manually flush system of dirt and debris during installation and system start-up
- Internal bleed for spray-free manual operation
- Operates in low-flow and Landscape Drip applications when a 200 mesh filter is installed upstream

Specifications

- Pressure: 15 to 150 PSI (1,0 to 10,3 bar)
- Flow: 0.2 to 30 GPM (0,05 to 6,82 m³/h; 0,01 to 1,89 l/s); for flows below 3 GPM (0,68 m³/h; 0,19 l/s) or any Landscape Drip application, use a 200 mesh filter installed upstream
- Operating Temperatures: Water temperature up to 110° F (43° C); ambient temperature up to 125° F (52° C)
- 24 VAC 50/60 Hz (cycles/sec.) solenoid
- Inrush current: 0.290A at 50/60 Hz
- Holding current: 0.091A at 50/60 Hz
- Solenoid Coil resistance: 70-85 Ohms (40° F - 110° F)



HV Valve Pressure Loss (psi)

Flow gpm	1" HV psi	1" HV-MB psi
1	1.57	1.73
3	2.07	2.03
5	2.38	2.25
10	3.33	2.80
20	4.59	4.45
30	6.14	7.85

HV Valve Pressure Loss (bar)

METRIC

Flow m ³ /h	l/m	1" HV bar	1" HV-MB bar
0.25	4.17	0.11	0.12
0.75	12.50	0.14	0.14
1.00	16.67	0.16	0.16
2.00	33.34	0.23	0.19
5.00	83.35	0.32	0.31
7.50	125.03	0.42	0.94

* Rain Bird recommends flow rates in the supply line not to exceed 7.5 ft/sec (2.3 m/s) in order to reduce the effects of water hammer

Dimensions

- Height: 4.62" (11.7 cm)
- Height (F): 5.62" (14.3 cm)
- Height (MB): 4.50" (11.4 cm)
- Length: 4.4" (11.2 cm)
- Length (MB): 5.68" (14.4 cm)
- Width: 3.1" (7.9 cm)

Models

- 100-HV-NPT: 1" NPT female x female*
- 100-HV-SS: 1" slip x slip
- 100-HV-MB: 1" male x barb
- 100-HVF-SS: 1" slip x slip

* Available with BSP threads. Also available with 9V DC Latching Solenoid.

Recommendations

1. Rain Bird recommends flow rates that result in discharge velocities in the supply line not to exceed 7.5 ft/sec (2.3 m/s) in order to reduce the effects of water hammer.
2. Rain Bird residential valves cannot be used with PRS pressure regulating modules.
3. **Not recommended for use with two-wire systems.**

How to Specify

100 - HV - SS

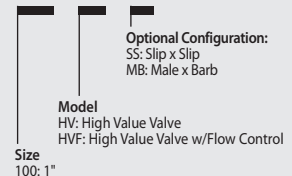

Note: For non-U.S. applications it is necessary to specify NPT or BSP thread type (1" only)

PGA Series

Plastic Globe and Angle Valves. The Toughest, Most Reliable Valves In their Class

Features

- Water-tight seal between the body and bonnet for maximum confidence, even in the most extreme conditions
- Robust construction and electrical design for quiet performance you can count on
- Filtered pilot flow to resist debris and clogging
- Slow closing to prevent water hammer and subsequent system damage
- Normally closed, forward flow design Accepts latching solenoid for use with Rain Bird battery-operated controllers
- Multi-drive screws (Phillips, flathead, hexagonal) for easy maintenance*
- Manual internal bleed operates the valve without allowing water into the valve box. This allows the pressure regulator to be adjusted without turning the valve on at the controller
- One-piece solenoid design with captured plunger and spring for easy servicing. Prevents loss of parts during field service
- Three-year trade warranty
- Accommodates optional, field-installed PRS-D pressure regulating dial to ensure optimum sprinkler performance
- Accepts latching solenoid for use with Rain Bird battery-operated controllers

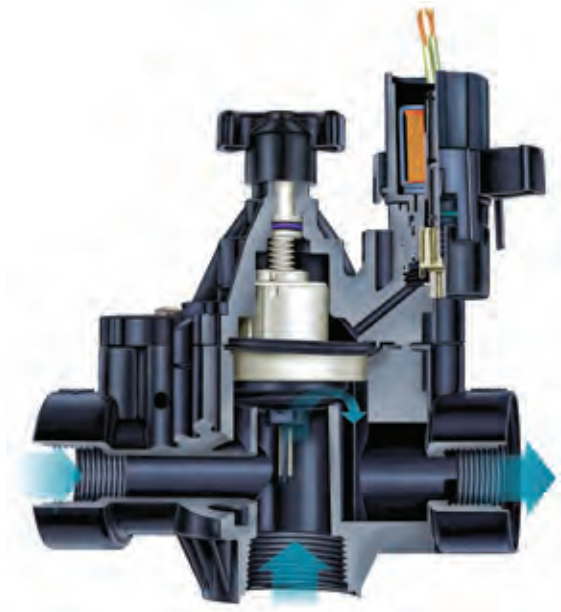

PGA Cutaway



150-PGA



Extreme Durability

The PGA valve maintains a strong, worry-free seal between the body and bonnet, no matter the conditions. PGA valves were exposed to extreme temperature swings and intense pressures. The result—zero leaks.*



Pressure-Resistant Seal

The PGA valve's body-to-bonnet seal is built to overcome the intense water pressure typical of many commercial sites. Faced with repeated pressure surges well into the triple digits, our valves outlasted the nearest competitor more than 2 ½ times to 1.*

*Based on 2013 testing conducted at Rain Bird's Product Research Facility in Tucson, AZ.

How to Specify

100 - PGA - PRS-D

<p>Size</p> <p>100: 1" NPT</p> <p>150: 1½" NPT</p> <p>200: 2" NPT</p>	<p>Model</p> <p>PGA</p>	<p>Optional Feature</p> <p>PRS-Dial: pressure regulating module (must be ordered separately)</p>
-----------------------------------------------------------------------	-------------------------	--------------------------------------------------------------------------------------------------

Note: Valve and PRS-Dial module must be ordered separately. For non-U.S. applications, it is necessary to specify NPT or BSP thread type.

PGA Series (cont.)

Options

- Accommodates optional, field installed PRS-D pressure regulating module to ensure optimum sprinkler performance. Regulates up to 100 psi (6.9 bar)
- Accepts latching solenoid for use with Rain Bird battery-operated controllers up to 150 psi (10,35 bar)
- Compatible with ESP-LXD decoders

Specifications

- Pressure: 15 to 150 psi (1.04 to 10.4 bar)
- Flow without PRS-D option: 2 to 150 gpm (0.45 to 34.05 m³/h; 7.8 to 568 l/m)
- Flow with PRS-D option: 5 to 150 gpm (1.14 to 34.05 m³/h; 19.2 to 568 l/m)
- Water temperature: Up to 110° F (43° C)
- Ambient temperature: Up to 125° F (52° C)
- 24VAC 50/60Hz (cycles/sec) solenoid power requirement
- Inrush current: 0.41A (9.9VA) at 50/60Hz
- Holding current: 0.14A (3.43VA) at 50/60Hz
- Solenoid coil resistance: 30-39 Ohms, nominal

Dimensions

Model	Height	Length	Width
• 100-PGA	7 ¼" (18.4 cm)	5 ½" (14.0 cm)	3 ¼" (8.3 cm)
• 150-PGA	8" (20.3 cm)	6 ¾" (17.2 cm)	3 ½" (8.9 cm)
• 200-PGA	10" (25.4 cm)	7 ¾" (19.7 cm)	5" (12.7 cm)

Note: PRS-Dial adds 2" (5.1 cm) to valve height

Models

- 100-PGA: 1" NPT
- 150-PGA: 1 ½" NPT
- 200-PGA: 2" NPT

BSP threads available; specify when ordering

Recommendations

1. Rain Bird recommends flow rates in the supply line not to exceed 7.5 ft/sec (2.29 m/s) in order to reduce the effects of water hammer
2. For flows below 5 gpm (1.14 m³/h; 19.2 l/m), Rain Bird recommends use of upstream filtration to prevent debris from collecting below the diaphragm
3. For flows below 10 gpm (2.27 m³/h; 37.8 l/m) Rain Bird recommends the flow control stem be turned down two full turns from the fully open position

PGA Series Valve Pressure Loss (psi)

Flow gpm	100-PGA Globe 1"	100-PGA Angle 1"	150-PGA Globe 1½"	150-PGA Angle 1½"	200-PGA Globe 2"	200-PGA Angle 2"
2	5.1	4.3	-	-	-	-
5	5.5	5.0	-	-	-	-
10	5.9	5.5	-	-	-	-
20	6.0	5.6	-	-	-	-
30	6.4	5.5	1.9	1.3	-	-
40	7.0	7.5	3.2	2.0	1.2	1.0
50	-	-	4.8	3.0	1.5	0.9
75	-	-	11.1	6.5	3.0	1.7
100	-	-	19.2	11.7	5.5	3.0
125	-	-	-	-	8.6	4.8
150	-	-	-	-	12.0	6.5

PGA Series Valve Pressure Loss (bar)

Flow m ³ /h	Flow l/m	100-PGA Globe 2.5cm	100-PGA Angle 2.5cm	150-PGA Globe 3.8cm	150-PGA Angle 3.8cm	200-PGA Globe 5.1cm	200-PGA Angle 5.1cm
0.5	7.6	0.35	0.30	-	-	-	-
1.2	20	0.38	0.35	-	-	-	-
3	50	0.41	0.38	-	-	-	-
6	100	0.43	0.38	0.10	0.07	-	-
9	150	0.48	0.51	0.22	0.14	0.08	0.07
12	200	-	-	0.38	0.23	0.12	0.07
15	250	-	-	0.61	0.36	0.17	0.10
18	300	-	-	0.86	0.51	0.24	0.13
21	350	-	-	1.16	0.70	0.33	0.18
24	400	-	-	-	-	0.43	0.23
27	450	-	-	-	-	0.54	0.30
30	500	-	-	-	-	0.66	0.36
34	568	-	-	-	-	0.83	0.45

PEB / PESB Series

Best-in-class Professional Series Plastic Irrigation Valves

Features

- Durable glass-filled nylon construction with fabric-reinforced rubber diaphragm for long life and reliable performance
- Globe configuration
- Normally closed, forward flow design
- Slow closing to prevent water hammer and subsequent system damage
- Low flow capability for a wide range of applications
- One-piece solenoid design with captured plunger and spring for easy servicing. Prevents loss of parts during field service
- Flow control handle adjusts water flows as needed
- Manual internal bleed manually operates the valve without allowing water into the valve box; allows pressure regulator to be adjusted without turning the valve on at the controller first
- Manual external bleed permits flushing debris from the system. Recommended for system start up and after repairs
- Stainless steel studs molded into the body. Bonnet can be attached and removed more easily and more often without damaging threads
- Nylon scrubber scrapes a stainless steel screen to clean and break down grit and plant material. Prevents debris build-up and clogging (PESB Series only)
- Five-year trade warranty

Specifications

- Pressure: 20 to 200 psi (1.4 to 13.8 bar)
- Flow without PRS-D option: 0.25 to 200 GPM (0.06 to 45 m³/h; 0.02 to 12.60 l/s)
- Flow with PRS-D option: 5 to 200 GPM (1.14 to 45 m³/h; 0.32 to 12.60 l/s)
- Temperature: Up to 150° F (66° C)
- 24VAC 50/60Hz (cycles/sec) solenoid power requirement
- Inrush current: 0.41A (9.9VA) at 50/60Hz
- Holding current: 0.14A (3.43VA) at 50/60Hz
- Solenoid coil resistance: 30-39 Ohms, nominal

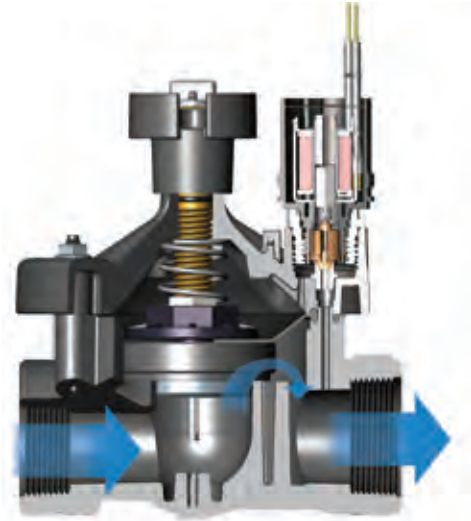

PEB Cutaway

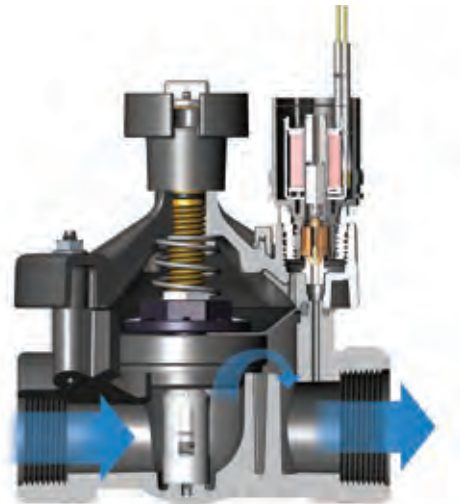

PESB Cutaway



150-PEB



150-PESB

How to Specify

100 - PEB - PRS-D

Size
100: 1" NPT
150: 1½" NPT
200: 2" NPT

Model
PEB

Optional Feature
PRS-Dial: pressure
regulating module
(must be ordered
separately)

Note: Valve and PRS-Dial module must be ordered separately. For non-U.S. applications, it is necessary to specify NPT or BSP thread type.

PEB / PESB Series (cont.)

Options

- Accommodates optional, field installed PRS-D pressure regulating module to ensure optimum sprinkler performance. Regulates up to 100 psi (6.9 bar)
- Accepts latching solenoid for use with Rain Bird battery-operated controllers up to 150 psi (10,35 bar)
- Compatible with ESP-LXD decoders
- Optional purple flow control handle for non-potable water applications PEB-NP-HAN1 (1"); PEB-NP-HAN2 (1 1/2" and 2")

Dimensions

Model	Height	Length	Width
• 100-PEB and 100-PESB:	6½" (16.5 cm)	4" (10.2 cm)	4" (10.2 cm)
• 150-PEB and 150-PESB:	8" (20.3 cm)	6" (15.2 cm)	6" (15.2 cm)
• 200-PEB and 200-PESB:	8" (20.3 cm)	6" (15.2 cm)	6" (15.2 cm)

Note: The PRS-Dial option adds 2" (5.1 cm) to valve height

Models

- 100-PEB and 100-PESB: 1" NPT
- 150-PEB and 150-PESB: 1½" NPT
- 200-PEB and 200-PESB: 2" NPT

BSP threads available; specify when ordering

Recommendations

1. Rain Bird recommends flow rates in the supply line not to exceed 7.5 ft/sec (2.29 m/s) in order to reduce the effects of water hammer
2. For flows below 5 gpm (1.14 m³/h; 19.2 l/m), Rain Bird recommends use of upstream filtration to prevent debris from collecting below the diaphragm
3. For flows below 10 gpm (2.27 m³/h; 37.8 l/m) Rain Bird recommends the flow control stem be turned down two full turns from the fully open position
4. For PRS-Dial applications, Rain Bird recommends the installation of a pressure-regulating master valve or inline pressure regulator when the inlet pressure exceeds 100 psi (6.9 bar)

PEB and PESB Series Valve Pressure Loss (psi)				
Flow gpm	100-PEB 1"	150-PEB 1½"	200-PEB 2"	
0.25	0.8	-	-	
0.5	1.0	-	-	
1	1.3	-	-	
5	1.7	-	-	
10	1.8	-	-	
20	2.9	3.9	-	
30	5.6	3.6	-	
40	10.0	3.5	-	
50	15.6	3.6	4.8	
75	-	5.4	4.5	
100	-	9.6	5.2	
125	-	14.6	8.2	
150	-	21.2	11.8	
175	-	-	15.5	
200	-	-	19.5	

PEB and PESB Series Valve Pressure Loss (bar)					METRIC
Flow m³/h	Flow l/m	100-PEB 2.5cm	150-PEB 3.8cm	200-PEB 5.1cm	
0.06	1	0.06	-	-	
0.3	5	0.09	-	-	
0.6	10	0.10	-	-	
1.2	20	0.12	-	-	
3	50	0.15	-	-	
6	100	0.32	0.26	-	
9	150	0.68	0.24	-	
12	200	-	0.26	0.33	
15	250	-	0.33	0.32	
18	300	-	0.42	0.32	
21	350	-	0.57	0.34	
24	400	-	0.74	0.41	
27	450	-	0.92	0.51	
30	500	-	1.14	0.64	
33	550	-	1.38	0.77	
36	600	-	-	0.90	
39	650	-	-	1.04	
42	700	-	-	1.18	
45	757	-	-	1.34	

Notes

1. Loss values are with flow control fully open
2. PRS-Dial recommended for use in shaded area only

PESB-R Series Valves

Durable Plastic – chlorine resistant Professional Plastic Irrigation Valves for reclaimed water irrigation applications

Features

- Plastic diaphragm and scrubber components molded of chlorine- and chemical-resistant plastic material
- Durable glass-filled nylon construction for long life and heavy-duty performance at 200 psi (13.80 bars) pressure
- Stainless steel studs molded into the body. Bonnet can be attached and removed easily without damaging threads
- One-piece solenoid design with captured plunger and spring for easy servicing. Prevents loss of parts during field service
- External bleed protects the solenoid ports from debris when system is flushed
- Internal bleed operates the valve without allowing water into the valve box; allows pressure regulator to be adjusted without turning on the valve at the controller first
- Slow closing to prevent water hammer and subsequent system damage
- Scrubber mechanism scrapes stainless steel screen clean to break down grit and plant material
- Purple flow control handle standard on PESB-R Series valves
- Five-year trade warranty

Options

- Accommodates optional, field installed PRS-D pressure regulating module to ensure optimum sprinkler performance. Regulates up to 100 psi (6.9 bar)
- Accepts latching solenoid for use with Rain Bird battery-operated controllers up to 150 psi (10.35 bar)
- Compatible with ESP-LXD decoders

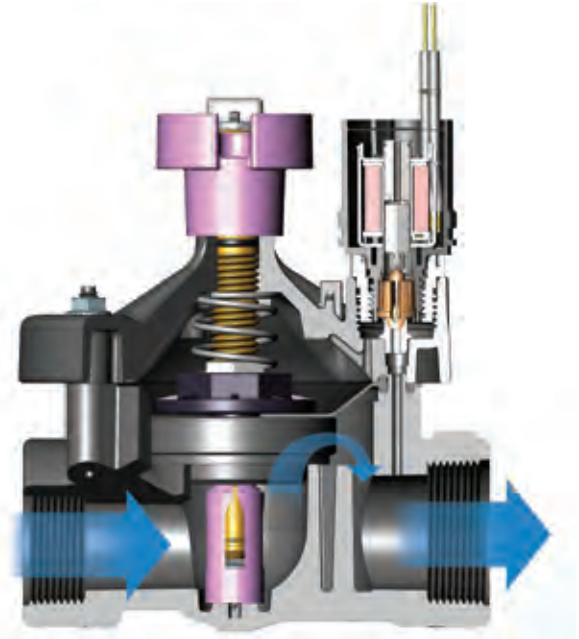

PESB-R Cutaway



150-PESB-R

How to Specify

100 - PESBR - PRS-D

Size 100: 1" NPT 150: 1½" NPT 200: 2" NPT	Model PESB-R: scrubber model	Optional Feature PRS-Dial: pressure regulating module (must be ordered separately)
----------------------------------------------------	---------------------------------------	------------------------------------------------------------------------------------------------

Note: Valve and PRS-Dial module must be ordered separately.

PESB-R Series (cont.)

Specifications

- Pressure: 20 to 200 psi (1.38 to 13.80 bar)
- Flow: 0.25 to 200 gpm (0.06 to 45.40 m³/h; 0.02 to 12.60 l/s)
- Flow with PRS-Dial: 5 to 200 gpm (1.14 to 45.40 m³/h; 0.32 to 12.60 l/s)
- Temperature: Up to 150° F (66° C)
- 24VAC 50/60Hz (cycles/sec) solenoid power requirement
- Inrush current: 0.41A (9.9VA) at 50/60Hz
- Holding current: 0.14A (3.43VA) at 50/60Hz
- Solenoid coil resistance: 30-39 Ohms, nominal

Dimensions

Model	Height	Length	Width
• 100-PESB-R	6½" (16.5 cm)	4" (10.2 cm)	4" (10.2 cm)
• 150-PESB-R	8" (20.3 cm)	6" (15.2 cm)	6" (15.2 cm)
• 200-PESB-R	8" (20.3 cm)	6" (15.2 cm)	6" (15.2 cm)

Note: The PRS-Dial option adds 2" (5.1 cm) to valve height

Models

- 100-PESB-R: 1" NPT
- 150-PESB-R: 1½" NPT
- 200-PESB-R: 2" NPT

BSP threads available, specify when ordering

Recommendations

1. Rain Bird recommends flow rates in the supply line not to exceed 7.5 ft/sec (2.29 m/s) in order to reduce the effects of water hammer
2. For flows below 5 gpm (1.14 m³/h; 19.21 l/m), Rain Bird recommends use of upstream filtration to prevent debris from collecting below the diaphragm
3. For flows below 10 gpm (2.27 m³/h; 37.8 l/m) Rain Bird recommends the flow control stem be turned down two full turns from the fully open position

PESB-R Series Valve Pressure Loss (psi)			
Flow gpm	100-PESB-R 1"	150-PESB-R 1½"	200-PESB-R 2"
0.25	1.6	-	-
0.5	3.0	-	-
1	1.8	-	-
5	2.9	-	-
10	2.9	-	-
20	2.6	3.5	-
30	5.8	3.1	-
40	10.2	2.3	-
50	16.0	2.1	3.7
75	-	4.3	3.3
100	-	7.5	4.7
125	-	11.9	8.6
150	-	17.0	12.6
175	-	-	14.8
200	-	-	18.9

PESB-R Series Valve Pressure Loss (bar)					METRIC
Flow m ³ /h	Flow l/m	100-PESB-R 2.5cm	150-PESB-R 3.8cm	200-PESB-R 5.1cm	
0.06	1	0.11	-	-	
0.3	5	0.13	-	-	
0.6	10	0.15	-	-	
1.2	20	0.20	-	-	
3	50	0.19	-	-	
6	100	0.32	0.22	-	
9	150	0.69	0.16	-	
12	200	-	0.16	0.25	
15	250	-	0.24	0.24	
18	300	-	0.33	0.25	
21	350	-	0.45	0.30	
24	400	-	0.59	0.38	
27	450	-	0.75	0.53	
30	500	-	0.91	0.67	
33	550	-	1.10	0.82	
36	600	-	-	0.92	
39	650	-	-	1.00	
42	700	-	-	1.13	
45	757	-	-	1.30	

Notes

1. Loss values are with flow control fully open
2. PRS-Dial recommended for use in shaded area only

EFB-CP Series Brass Valves

Highly durable Brass Irrigation Valves - Globe Configuration

Features

- Reliable performance even in dirty water applications. Self-flushing filter resists debris build-up
- Rugged red brass construction for longer life
- Durable, fabric-reinforced diaphragm composed of EPDM, a rubber material which is chlorine and chemical resistant
- Normally closed, reverse flow design ensures valve will fail in the closed position if a tear or rip in the diaphragm occurs. Prevents flooding, water waste and landscape damage
- Slow closing to prevent water hammer and subsequent system damage
- One-piece solenoid design with captured plunger and spring for easy servicing. Prevents loss of parts during field service
- Manual internal bleed operates the valve without allowing water into the valve box. Allows pressure regulator adjustment without turning on the controller
- Manual external bleed permits flushing debris from the system. Recommended for system start up and other repairs
- Contamination-proof, self-flushing filter screen resists debris build-up. Water flow continuously flushes the screen, dislodging particles and debris before they can accumulate and clog the filter
- Reclaimed water compatible: all models now feature EPDM diaphragms and chlorine-resistant parts as standard equipment
- Three-year trade warranty

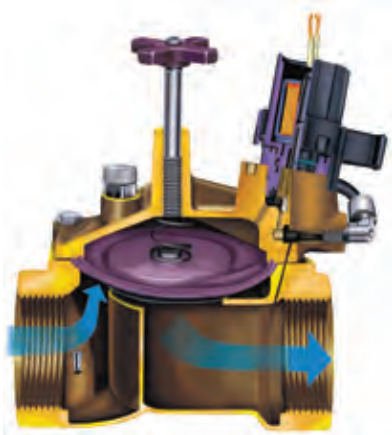

EFB-CP Cutaway



150-EFB-CP

Options

- Accommodates optional, field installed PRS-D pressure regulating module to ensure optimum sprinkler performance. Regulates up to 100 psi (6.9 bar)
- Accepts latching solenoid for use with Rain Bird battery-operated controllers up to 150 psi (10.35 bar)
- Compatible with ESP-LXD decoders

Specifications

- Pressure: 15 to 200 psi (1.04 to 13.80 bar)
- Flow with/without PRS-D: 5 to 200 GPM (1.14 to 45.40 m³/h; 0.32 to 12.60 l/s)
- Temperature: up to 150° F (66° C)
- 24VAC 50/60Hz (cycles/sec) solenoid power requirement
- Inrush current: 0.41A (9.9VA) at 50/60Hz
- Holding current: 0.14A (3.43VA) at 50/60Hz
- Solenoid coil resistance: 30-39 Ohms, nominal

Dimensions

Model	Height	Length	Width
• 100-EFB-CP:	6" (15.2 cm)	4½" (11.4 cm)	3¼" (8.3 cm)
• 150-EFB-CP:	6½" (16.5 cm)	5½" (14 cm)	4½" (11.4 cm)
• 200-EFB-CP:	7" (17.8 cm)	6¾" (17.1 cm)	5¾" (14.6 cm)

Note: The PRS-Dial option adds 2" (5.1 cm) to the valve height

Models

- 100-EFB-CP: 1" NPT
- 150-EFB-CP: 1½" NPT
- 200-EFB-CP: 2" NPT*

* BSP threads available; specify when ordering

Recommendations

1. Rain Bird recommends flow rates in the supply line not to exceed 7.5 ft/sec (2.29 m/s) in order to reduce the effects of water hammer
2. For flows below 5 gpm (1.14 m³/h; 19.21 l/m), Rain Bird recommends use of upstream filtration to prevent debris from collecting below the diaphragm
3. For flows below 10 gpm (2.27 m³/h; 37.8 l/m) Rain Bird recommends the flow control stem be turned down two full turns from the fully open position

How to Specify

100 - EFB-CP - PRS-D

Size	Model	Optional Feature
100: 1" NPT	EFB-CP	PRS-Dial: pressure regulating module (must be ordered separately)
150: 1½" NPT		
200: 2" NPT		

Note: Valve and PRS-Dial module must be ordered separately.

EFB-CP Series (cont.)

EFB-CP Series Valve Pressure Loss (psi)			
Flow gpm	100-EFB-CP 1"	150-EFB-CP 1½"	200-EFB-CP 2"
5	0.2	-	-
10	0.7	-	-
15	1.2	-	-
20	2.1	2.3	0.5
30	5	2.9	0.6
40	8.2	2	0.8
50	13	3.3	1.1
60	-	4.6	1.8
80	-	7.5	2.4
100	-	11.8	3.8
120	-	16.6	5.9
140	-	-	7.8
160	-	-	10
180	-	-	12.5
200	-	-	15.8

EFB-CP Series Valve Pressure Loss (bar)				METRIC
Flow m³/h	Flow l/m	100-EFB-CP 2.5cm	150-EFB-CP 3.8cm	200-EFB-CP 5.1cm
1	19	0.01	-	-
3	50	0.07	-	-
6	100	0.27	0.19	0.04
9	150	0.56	0.14	0.05
12	200	-	0.25	0.09
15	250	-	0.38	0.14
18	300	-	0.51	0.16
21	350	-	0.70	0.23
24	400	-	0.91	0.30
27	450	-	1.13	0.40
30	500	-	-	0.49
33	550	-	-	0.58
36	600	-	-	0.68
39	650	-	-	0.79
42	700	-	-	0.92
45	757	-	-	1.09

Notes

- Loss values are with flow control fully open
- PRS-Dial module recommended for all flow rates

300-BPES Brass Valves

3" Brass Master Valve - Globe and angle configuration

Features

- Unique hybrid construction featuring durable red brass body and glass-filled nylon bonnet for long life at a value price
- Normally closed, forward flow design
- Slow closing to prevent water hammer and subsequent system damage
- Robust solenoid provides dependable performance even during constant operation
- Flow control handle adjusts water flows as needed and incorporates a brass thread insert for longer life
- Manual internal bleed operates the valve without allowing water into the valve box. Allows pressure regulator adjustment without turning the valve on at the controller
- Manual external bleed permits flushing debris from the system. Recommended for system start up and repairs
- Highly efficient operation with extremely low pressure loss
- Patented nylon scrubber scrapes a stainless steel screen to clean and break down grit and plant material. Prevents debris build-up and clogging
- Three-year trade warranty

Options

- Accommodates field-installed PRS-D pressure regulating module to ensure optimum sprinkler performance
- Purple flow control handle for non-potable water applications
- Latching solenoid for use with Rain Bird battery-operated controllers up to 150 psi (10.4 bar)

Specifications

- Pressure: 20 to 200 psi (1.4 to 13.8 bar)
- Flow with/without PRS-D option: 60 to 300 gpm (13.6 to 68.1 m³/h; 3.78 to 18.90 l/s)
- Temperature: up to 140° F (60° C)
- Power: 24 VAC 50/60 Hz (cycles/sec) solenoid
- Inrush current: 0.41 A (9.8 VA) at 50/60Hz
- Holding current: 0.14 A (3.43 VA) at 50/60Hz
- Coil resistance: 30-39 Ohms, nominal

How to Specify

300 - BPES - PRS-D

Size 3" NPT	Model BPES	Optional Feature PRS-Dial: pressure regulating module (must be ordered separately)
----------------	---------------	------------------------------------------------------------------------------------------------

Note: Valve and PRS-Dial module must be ordered separately. For non-U.S. applications, it is necessary to specify NPT or BSP thread type.



300-BPES

BPES 3" Valve Pressure Loss (psi)		
Flow gpm	Globe	Angle
60	6.6	6.8
80	5.1	5.9
100	3.2	3.5
120	1.8	1.8
140	1.8	2.1
160	2.0	2.1
180	2.2	2.0
200	2.7	2.5
250	4.0	3.4
300	4.9	4.5

BPES 3" Valve Pressure Loss (bar)			METRIC
Flow m ³ /h	l/s	Globe	Angle
13.6	227	0.46	0.47
24	400	0.19	0.21
36	600	0.14	0.14
48	800	0.21	0.19
60	1000	0.29	0.26
68	1136	0.34	0.31

Notes

1. Loss values are with flow control fully open
2. PRS-Dial module recommended for all flow rates

Dimensions

Model	Height	Length	Width
• 300	13 ⁵ / ₈ " (34.61 cm)	8" (20.32 cm)	7" (17.78 cm)

Models

- 300-BPES: 3" NPT
- BSP threads available; specify when ordering

Recommendations

1. Rain Bird recommends flow rates in the supply line not to exceed 7.5 ft/sec (2.29 m/s) in order to reduce the effects of water hammer.
2. For flows below 5 gpm (1.14 m³/h; 19.2 l/m), Rain Bird recommends use of upstream filtration to prevent debris from collecting below the diaphragm.
3. For flows below 10 gpm (2.27 m³/h; 37.8 l/m) Rain Bird recommends the flow control stem be turned down two full turns from the fully open position.

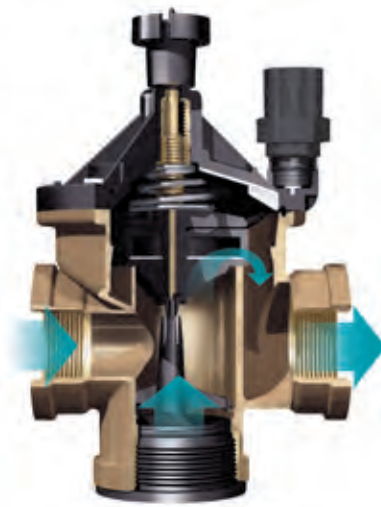

BPES Cutaway

WC Series Wire Connector

Connections Made Easy

Features and Benefits

- Install Faster – the WC Series Wire Connector is quick to install and provides reliable moisture sealing for controller and valve electrical connections you can count on
- Simplify Inventory – This is the only wire connector you'll need! It is ideal for use on two wire decoder control systems
- Avoid Call Backs – Locating and repairing a corroded wire splice costs your business time and money. Avoid unnecessary service call backs
- Use for standard controllers, valve boxes and soil moisture sensors
- Wire combinations ranging from 22ga to 8ga
- Use on connections from 24 VAC to 600 VAC
- UL 486D certified for direct burial
- The Strain Relief ensures wires are secure and won't pull apart
- Waterproof silicone sealant protects against corrosion
- UV-resistant material ensures product performance does not degrade even after long periods of exposure to sunlight

Models

- WC20: Direct Bury Silicone Tube, Red Yellow Wire Nut, Bag of 20



WC20

Wire Combinations (for solid and stranded wire)

WC20	
2-3 #10	2#18
2-5 #12	1 #8 w/2 #18
2-5 #14	3 #10 w/1 #18
4-6 #16	3 #12 w/3 #18
3 #14 w/2 #18	

The combinations listed are only a sample of the most common wire combinations.

PRS-Dial

Pressure Regulating Module

Features

- The PRS-Dial is an excellent means of regulating outlet pressure at the valve regardless of incoming pressure fluctuations. The visible scale makes adjustment quick and easy. The regulator fits all Rain Bird PGA, PEB, PESB, PESB-R, EFB-CP, and BPES series valves
- Regulates and maintains constant outlet pressure between 15 and 100 psi (1.04 to 6.9 bar) within ± 3 psi (± 0.21 bar)
- Ergonomic design with snap-tight cover to prevent vandalism
- Waterproof dial cartridge eliminates fogging and binding
- Dial cartridge retrofits into all existing PRS-D units
- Schrader valve connects pressure hose gauge
- Easy field installation. PRS-Dial threads underneath the solenoid and adapter
- Corrosion-resistant glass-filled nylon for rugged performance

Operating Range

- Pressure: Up to 100 psi (6.9 bar)*
- Regulation: 15 to 100 psi (1.04 to 6.9 bar)
- Flow: Refer to chart

* While the PRS-Dial unit can withstand pressures up to 200 psi (13.8 bar), accurate pressure regulation can be maintained only up to 100 psi (6.9 bar)

Model

- PRS-D

Application Information

- Proper operation requires inlet pressure to be a minimum of 15 psi (1.04 bar) higher than desired outlet pressure
- For areas with very high pressure or uneven terrain, install sprinklers with PRS pressure regulating stems and/or SAM check valves
- When inlet pressure exceeds 100 psi (6.9 bar), a pressure regulating master valve or inline pressure regulator is required
- Rain Bird does not recommend using the pressure regulating module for applications outside the recommended flow ranges
- To reduce the effects of water hammer, Rain Bird recommends flow rates in the supply line not to exceed 7.5 ft/sec (2.29 m/s)
- For flows below 10 gpm (2.27 m³/h; 37.8 l/m), Rain Bird recommends the flow control stem be turned down two full turns from the fully open position

† Note: Valve and PRS-Dial module must be ordered separately.

Valve Flow Ranges*

Model	gpm	m ³ /h	l/m
100-PGA	5-40	1.14-9.08	19.2-151
150-PGA	30-100	6.81-22.70	113-378
200-PGA	40-150	9.08-34.05	151-568
100-PEB	5-50	1.14-11.35	19.2-189
150-PEB	20-150	4.54-34.05	76-568
200-PEB	75-200	17.03-45.40	284-757
100-PESB/PESB-R	5-50	1.14-11.35	19.2-189
150-PESB/PESB-R	20-150	4.54-34.05	76-568
200-PESB/PESB-R	75-200	17.03-45.40	284-757
100-EFB-CP	5-50	1.14-11.35	19.2-189
125-EFB-CP	20-80	4.54-18.16	76-302
150-EFB-CP	20-120	4.54-31.78	76-529
200-EFB-CP	20-200	4.54-45.40	76-757
300-BPES	60-300	13.62-68.10	227-1136

* These are the valve flow ranges.



Quick-Coupling Valves

Convenient water access in potable and non-potable systems

Features

- Optional locking cover on models 33-DLRC, 44-LRC, 5-LRC, 33-DNP, 44-NP, and 5-NP (use 2049 key to unlock). Metal cover on model 7 only
- One-piece body design (models 3-RC, 5-RC and 7)
- Two-piece body design for easy servicing (models 33-DRC, 44-LRC, 44-RC, 33-DNP, and 44-NP)
- Strong corrosion-resistant stainless steel spring prevents leakage
- Thermoplastic cover for durability
- 33-DNP, 44-NP, and 5-NP covers marked with "Do Not Drink!" warnings in English and Spanish
- Three-year trade warranty

Specifications

- Pressure: 5 to 125 psi (0.35 to 8.63 bar)
- Flow: 10 to 125 gpm (2.27 to 28.38 m³/h; 37.8 to 473 l/m)
- 33-DNP, 44-NP, and 5-NP flow: 10 to 70 gpm (2.27 to 15.89 m³/h; 37.8 to 265 l/m)

Dimensions (height)

- 3-RC: 4¼" (10.8 cm) • 44-RC: 6" (15.2 cm) • 7: 5¾" (14.6 cm)
- 33-DRC: 4¾" (11.1 cm) • 44-LRC: 6" (15.2 cm) • 33-DNP: 4¾" (11.1 cm)
- 33-DLRC: 4¾" (11.7 cm) • 5-RC: 5½" (14.0 cm) • 44-NP: 6" (15.2 cm)
- 5-LRC: 5½" (14.0 cm) • 5-NP: 5½" (14.0 cm)

Models

- 3-RC: ¾" NPT Rubber Cover, 1-Piece Body
- 33-DRC: ¾" NPT Double Track Key Lug, Rubber Cover, 2-Piece Body
- 33-DLRC: ¾" NPT Double Track Key Lug, Locking Rubber Cover, 2-Piece Body
- 44-RC: 1" NPT Rubber Cover, 2-Piece Body
- 44-LRC: 1" NPT Locking Rubber Cover, 2-Piece Body
- 5-RC: 1" NPT Rubber Cover, 1-Piece Body
- 5-LRC: 1" NPT Locking Rubber Cover, 1-Piece Body
- 7: 1½" NPT Metal Cover, 1-Piece Body
- 5-RC-BSP: 1" BSP Rubber Cover, 1-Piece Body, BSP threaded
- 5-LRC-BSP: 1" BSP Locking Rubber Cover, 1-Piece Body, BSP threaded
- 33-DNP: ¾" NPT Non-potable, Purple Locking Rubber Cover, 2-Piece Body
- 44-NP: 1" NPT Non-potable, Purple Locking Rubber Cover, 2-Piece Body
- 5-NP: 1" NPT Non-potable, Purple Locking Rubber Cover, 1-Piece Body

Quick-Coupling Valves Pressure Loss (psi)

Flow	3-RC	33-DRC 33-DLRC 33-DNP	44-RC 44-LRC 44-NP	5-RC 5-LRC 5-NP	7
gpm	¾"	¾"	1"	1"	1½"
10	1.8	2	-	-	-
15	4.7	4.3	2.2	-	-
20	7.2	7.6	4.4	-	-
30	-	-	11.5	4.1	-
40	-	-	-	7.3	-
50	-	-	-	11	1.7
60	-	-	-	15.7	2.5
70	-	-	-	21.5	3.6
80	-	-	-	-	4.9
100	-	-	-	-	8.4
125	-	-	-	-	14

Quick-Coupling Valves Pressure Loss (bar)

Flow	3-RC	33-DRC 33-DLRC 33-DNP	44-RC 44-LRC 44-NP	5-RC 5-LRC 5-NP	7	
m ³ /h	l/m	1.9 cm	1.9 cm	2.5 cm	2.5 cm	3.8 cm
2.3	38	0.12	0.12	-	-	-
4	67	0.41	0.42	0.23	-	-
5	83	0.57	0.62	0.4	-	-
6	100	-	-	0.62	-	-
7	117	-	-	0.83	0.3	-
8	133	-	-	-	0.4	-
9	150	-	-	-	0.5	-
10	167	-	-	-	0.61	-
12	200	-	-	-	0.85	0.13
14	233	-	-	-	1.15	0.18
16	267	-	-	-	1.5	0.25
22	367	-	-	-	-	0.54
28	473	-	-	-	-	0.97



Quick-Coupling Valve Cutaway



Quick Coupling Valves

Valve Keys

Quick-Coupling Keys

Features

- Key threads into top of quick-coupling valve to provide water access

Models

- 33-DK: 3/4" NPT
- 44-K: 1" NPT
- 55-K-1: 1" NPT
- 7-K: 1 1/2" NPT



55-K-1

Corresponding Valve Keys

Valve	Key	Top Pipe Threads	
		Valve	Valve
3-RC	33-DK	3/4"	1/2"
33-DRC/33-NP	33-DK	3/4"	1/2"
44-RC/44-NP	44-K	1"	3/4"
5-RC/5-NP	55-K-1	1"	-
7	7-K	1 1/2"	1 1/4"

SH Series

Hose Swivel

Features

- Attaches water hose to quick-coupling valve key
- Swivels up to 360°
- Allows hose to be pulled in any direction
- Prevents hose damage

Specifications

- SH-0: 3/4" NPT female pipe thread x 3/4" NPT male hose thread
- SH-1: 1" NPT female pipe thread x 3/4" NPT male hose thread
- SH-2: 1" NPT female pipe thread x 1" NPT male hose thread
- SH-3: 1 1/2" NPT female pipe thread x 1" NPT male hose thread

Models

- SH-0
- SH-1
- SH-2*
- SH-3

*Available with BSP threads



SH-0

Locking Cover Key

Features

- Locks and unlocks the optional locking cover on quick-coupling valves
- Operates the valve marker compression lock
- Compatible with models 33-DLRC, 33-DNP, 44-LRC, 44-NP, 5-LRC, and 5-NP

Model

- 2049 Cover Key



2049

Purple Valve Handle Assembly

Features

- Purple flow control handle identifies valve as part of a non-potable system
- Easily field installed
- Sizes for all Rain Bird Commercial Valves

Models

- PEB-NP-HAN1 (1" PEB/PESB Valves)
- PEB-NP-HAN2 (1 1/2" and 2" PEB/PESB Valves)



PEB-NP-HAN

24 VAC Solenoid Valves Wire Sizing – 50Hz

9.8 VA Valves (EZ) with 26.5 Volt Transformers - Equivalent Feet of Circuit								
80 psi (5.5 bar) Water Pressure at Valve								
Common Wire Size	Control Wire Size		14 ●	12 ●	10 ●	8 ●	6 ●	4 ●
	18 ●	16 ●						
18	3700							
16	4600	6000						
14	5400	7400	9600					
12	6000	8600	11800	15200				
10	6500	9600	13700	18700	24200			
8	6900	10400	15400	21800	29700	38500		
6	7100	10900	16600	24300	34600	47100	60600	
4	7300	11300	17500	26300	38800	55100	74600	97000
100 psi (6.9 bar) Water Pressure at Valve								
Common Wire Size	Control Wire Size		14 ●	12 ●	10 ●	8 ●	6 ●	4 ●
	18 ●	16 ●						
18	3200							
16	4000	5200						
14	4700	6400	8300					
12	5200	7400	10200	13200				
10	5600	8300	11900	16200	20900			
8	5900	9000	13300	18900	25700	33300		
6	6100	9500	14300	21100	29900	40700	52400	
4	6300	9800	15100	22800	33500	47700	64600	83900
125 psi (8.6 bar) Water Pressure at Valve								
Common Wire Size	Control Wire Size		14 ●	12 ●	10 ●	8 ●	6 ●	4 ●
	18 ●	16 ●						
18	2900							
16	3500	4600						
14	4100	5700	7400					
12	4600	6600	9000	11700				
10	5000	7400	10500	14400	18600			
8	5300	8000	11800	16800	22800	29600		
6	5400	8400	12700	18700	26600	36200	46600	
4	5600	8700	13400	20200	29800	42300	57300	74600
150 psi (10.4 bar) Water Pressure at Valve								
Common Wire Size	Control Wire Size		14 ●	12 ●	10 ●	8 ●	6 ●	4 ●
	18 ●	16 ●						
18	2600							
16	3200	4100						
14	3700	5000	6600					
12	4100	5900	8100	10400				
10	4500	6600	9400	12800	16600			
8	4700	7100	10500	15000	20400	26400		
6	4900	7500	11400	16700	23800	32300	41600	
4	5000	7800	12000	18100	26600	37800	51300	66600
200 psi (13.8 bar) Water Pressure at Valve								
Common Wire Size	Control Wire Size		14 ●	12 ●	10 ●	8 ●	6 ●	4 ●
	18 ●	16 ●						
18	2400							
16	2900	3800						
14	3400	4700	6100					
12	3800	5500	7500	9700				
10	4100	6100	8800	11900	15500			
8	4400	6600	9800	13900	19000	24600		
6	4500	7000	10600	15500	22100	30100	38700	
4	4600	7200	11100	16800	24800	35200	47700	62000

Commercial Valve Wire Sizing Procedure

Step 1

Determine actual distance, along wire run, from controller out to the first valve on a circuit and between each succeeding valve on a multiple valve circuit. Example: (Two watt solenoid, 26.5 volt transformer, 50Hz, at 150 psi water pressure at valves.)

Step 2

Calculate the equivalent circuit length for each valve circuit on the controller. (See chart to left)

Step 3

Selecting Common Wire Size: Using the longest equivalent length calculated above, go to the appropriate valve chart and select a common wire and a control wire that are as close to the same size as possible (the common wire size should always be equal to or one size larger than the control wire size.) In the example above, the circuit for station #3 has the longest equivalent length, 7000 feet. In the chart (for this example use the chart for 150 psi water pressure at the valve and a 26.5 volt transformer) select a wire size combination of size 14 and 12 wire. Select common wire as size 12 wire. Since one common wire shall be used for all valves on the controller, you have now established the common wire size for that controller as size 12 wire.

Step 4

Sizing Circuit Control Wires: Reading only from the row for the common wire size selected in Step 3 (size 12), proceed to select each control wire size from the chart using the calculated equivalent length for each circuit.

EXAMPLE:

Station #1: Equiv. Length = 1 valve x 2000 ft. = 2000 ft. select size 18 control wire

Station #2: Equiv. Length = (1 valve x 1000 ft.) + (2 valves x 2000 ft.) = 5000 ft. select size 16 control wire

Station #3: Equiv. Length = (1 valve x 500 ft.) + (2 valves x 1000 ft.) + (3 valves x 1500 ft.) = 7000 ft. select size 14 control wire

24 VAC Solenoid Valves Wire Sizing – 60Hz

9.8 VA Valves (EZ) with 26.5 Volt Transformers - Equivalent Feet of Circuit

80 psi (5.5 bar) Water Pressure at Valve

Common Wire Size	Control Wire Size		14 ●	12 ●	10 ●	8 ●	6 ●	4 ●
	18 ●	16 ●						
18	3200							
16	4000	5200						
14	4700	6400	8300					
12	5200	7500	10200	13200				
10	5700	8300	11900	16200	21000			
8	6000	9000	13300	18900	25800	33400		
6	6200	9500	14400	21100	30100	40900	52600	
4	6300	9800	15200	22900	33700	47800	64800	84200

100 psi (6.9 bar) Water Pressure at Valve

Common Wire Size	Control Wire Size		14 ●	12 ●	10 ●	8 ●	6 ●	4 ●
	18 ●	16 ●						
18	2900							
16	3500	4600						
14	4100	5600	7300					
12	4600	6600	9000	11700				
10	5000	7400	10500	14300	18600			
8	5300	8000	11800	16700	22800	29500		
6	5400	8400	12700	18700	26500	36100	46500	
4	5600	8700	13400	20200	29700	42200	57200	74400

125 psi (8.6 bar) Water Pressure at Valve

Common Wire Size	Control Wire Size		14 ●	12 ●	10 ●	8 ●	6 ●	4 ●
	18 ●	16 ●						
18	2400							
16	3000	3900						
14	3500	4800	6300					
12	3900	5600	7700	9900				
10	4300	6300	9000	12200	15800			
8	4500	6800	10000	14300	19400	25200		
6	4600	7100	10800	15900	22700	30800	39700	
4	4700	7400	11400	17200	25400	36100	48800	63500

150 psi (10.4 bar) Water Pressure at Valve

Common Wire Size	Control Wire Size		14 ●	12 ●	10 ●	8 ●	6 ●	4 ●
	18 ●	16 ●						
18	2200							
16	2700	3500						
14	3100	4300	5600					
12	3500	5000	6800	8800				
10	3800	5600	8000	10900	14100			
8	4000	6000	8900	12700	17300	22400		
6	4100	6300	9600	14100	20100	27400	35300	
4	4200	6600	10200	15300	22600	32100	43400	56500

200 psi (13.8 bar) Water Pressure at Valve

Common Wire Size	Control Wire Size		14 ●	12 ●	10 ●	8 ●	6 ●	4 ●
	18 ●	16 ●						
18	1800							
16	2300	2900						
14	2600	3600	4700					
12	3000	4200	5800	7500				
10	3200	4700	6800	9200	12000			
8	3400	5100	7600	10800	14700	19000		
6	3500	5400	8200	12000	17100	23300	30000	
4	3600	5600	8600	13000	19200	27300	36900	48000

Commercial Valve Wire Sizing Procedure

Step 1

Determine actual distance, along wire run, from controller out to the first valve on a circuit and between each succeeding valve on a multiple valve circuit. Example: (Two watt solenoid, 26.5 volt transformer, 60Hz, at 150 psi water pressure at valves.)

Step 2

Calculate the equivalent circuit length for each valve circuit on the controller. (See chart to left)

Step 3

Selecting Common Wire Size: Using the longest equivalent length calculated above, go to the appropriate valve chart and select a common wire and a control wire that are as close to the same size as possible (the common wire size should always be equal to or one size larger than the control wire size.) In the example below, the circuit for station #3 has the longest equivalent length, 7000 feet. In the chart (for this example use the chart for 150 psi water pressure at the valve and a 26.5 volt transformer) select a size 12 wire for both common and control wire. Since one common wire shall be used for all valves on the controller, you have now established the common wire size for that controller as size 12 wire.

Step 4

Sizing Circuit Control Wires: Reading only from the row for the common wire size selected in Step 3 (size 12), proceed to select each control wire size from the chart using the calculated equivalent length for each circuit.

EXAMPLE:

Station #1: Equiv. Length = 1 valve x 2000 ft. = 2000 ft. select size 18 control wire

Station #2: Equiv. Length = (1 valve x 1000 ft.) + (2 valves x 2000 ft.) = 5000 ft. select size 16 control wire

Station #3: Equiv. Length = (1 valve x 500 ft.) + (2 valves x 1000 ft.) + (3 valves x 1500 ft.) = 7000 ft. select size 12 control wire

PVB Professional Series Valve Boxes

The PVB Series valve box provides rugged, no-nonsense dependability, with a price tag that can meet any budget

Features

- Light & durable construction
- Side ridges for additional side wall support
- Pre-molded pipe slots
- Bottom flanges to help prevent sinking
- Four colors: available in green, black, tan and purple
- Multiple configurations designed to provide tight seals and easy maintenance access
- Earth-friendly, LEED-compliant material made of 100% recycled materials (black boxes and black lids only)



6" Round Valve Box	10" Round Valve Box	Mini Standard Valve Box	Standard Valve Box	Standard Extension	Jumbo Valve Box	Jumbo Extension
SIZE						
Top Opening: 6 1/8" diameter Bottom Opening: 8 5/8" diameter	Top Opening: 10" diameter Bottom Opening: 12 1/8" diameter	Top Opening: 15" L x 9 1/2" W Bottom Opening: 18" L x 12 1/2" W x 10" H	Top Opening: 18 1/4" L x 13" W Bottom Opening: 21 1/4" L x 15 1/8" W x 12" H	Top Opening: 17" L x 11 3/4" W Bottom Opening: 18 5/8" L x 13 5/8" W x 6 3/4" H	Top Opening: 22 1/4" L x 16 3/8" W Bottom Opening: 25 1/4" L x 19 3/8" W x 12" H	Top Opening: 21 3/8" L x 15 7/8" W Bottom Opening: 22 1/8" L x 16 3/8" W x 6 5/8" H
ADDITIONAL FEATURES						
<ul style="list-style-type: none"> • Snap-in overlapping lid • Skid-resistant texture • Body built with three ridges for additional sidewall support 	<ul style="list-style-type: none"> • Overlapping lid with bolt hole and twist lock • Skid-resistant lid texture • Body built with double ridges for additional sidewall support 	<ul style="list-style-type: none"> • Our compact alternative to a standard size box • Drop-in lid • Skid-resistant lid texture 	<ul style="list-style-type: none"> • Drop-in lockable lid • Skid-resistant lid texture • Double ledge lid support • Ridge adds additional support to sidewalls 	<ul style="list-style-type: none"> • Overlapping lockable lid • Skid-resistant lid texture • Body can be used to extend the PVB Standard series • Body can be used as a 6" deep box 	<ul style="list-style-type: none"> • Drop-in lockable lid • Skid-resistant lid texture • Double ledge lid support • Ridge adds additional support to sidewalls 	<ul style="list-style-type: none"> • Overlapping lockable lid • Skid-resistant lid texture • Body can be used to extend the PVB Jumbo series • Body can be used as a 6" deep box
MODELS						
<ul style="list-style-type: none"> • PVB6RND: 6" round black body & overlapping green lid 	<ul style="list-style-type: none"> • PVB10RND: 10" round black body & overlapping green lid 	<ul style="list-style-type: none"> • PVBMST: 10" mini-standard black body & drop-in green lid 	<ul style="list-style-type: none"> • PVBSTD: 12" standard black body & drop-in green lid • PVBSTDP: 12" standard purple body & drop-in purple lid 	<ul style="list-style-type: none"> • STDEXT body can extend the Standard Valve box by 6" in height • STDEXT body can be used as a 6" deep box to reduce digging • PVBSTDEXT: 6" black body & overlapping green lid • PVBSTDEXTT: 6" tan body & overlapping tan lid 	<ul style="list-style-type: none"> • PVBJMB: 12" black body & drop-in green lid • PVBJMBP: 12" purple body & drop-in purple lid 	<ul style="list-style-type: none"> • PVBJMBEXT: 6" black body & overlapping green lid

VB Series Valve Boxes

Commercial grade boxes that are loaded with a rich set of industry-leading features

Features

- **Strength and Stability** – Multiple sizes and shapes are designed with corrugated sides and wide flange bases for maximum durability, compression strength, and stability
- **Smart Lid Design** – Designed with no holes to keep out pests, beveled edges to minimize damage potential from turf equipment, and for easy hand and shovel access
- **Flexible Installations** – Interlocking stacking capabilities, extension models and pipe hole knockouts support deeper and flexible installations
- **Environmentally Friendly** – Earth-friendly, LEED-compliant material made of 100% recycled materials (black boxes and black lids only)



7 Inch Round Valve Box	10 Inch Round Valve Box	Standard Valve Box	Standard Extension	Jumbo Valve Box	Jumbo Extension	Super Jumbo Valve Box	Maxi Jumbo Valve Box
SIZE							
Bottom Diameter: 8.4 inches (21,4 cm) Height: 9.2 inches (23,4 cm)	Bottom Diameter: 11.8 inches (30,0 cm) Height: 10.2 inches (26,0 cm)	Length: 23.2 inches (59,0 cm) Width: 19.3 inches (49,1 cm) Height: 12.5 inches (31,8 cm)	Length: 20.0 inches (50,8 cm) Width: 14.75 inches (37,5 cm) Height: 6.75 inches (17,1 cm)	Length: 27.6 inches (70,0 cm) Width: 21.0 inches (53,2 cm) Height: 12.5 inches (31,6 cm)	Length: 24.4 inches (62,0 cm) Width: 17.9 inches (45,5 cm) Height: 6.75 inches (17,2 cm)	Length: 33.1 inches (84,1 cm) Width: 23.9 inches (60,7 cm) Height: 15.0 inches (38,1 cm)	Length: 40.4 inches (102,5 cm) Width: 27.1 inches (68,9 cm) Height: 18.0 inches (45,7 cm)
ADDITIONAL FEATURES							
<ul style="list-style-type: none"> • Easily removable knock-outs simplify pipe placement and reduce installation time • Four equally spaced knock-outs accommodate up to 2.0" diameter pipe 	<ul style="list-style-type: none"> • Easily removable knock-outs simplify pipe placement and reduce installation time • Four equally spaced knock-outs accommodate up to 2.0" diameter pipe 	<ul style="list-style-type: none"> • Two large center knock-outs accommodate up to 3 1/2" (8.9 cm) diameter pipe and eleven knock-outs accommodate up to 2" (5.0 cm) diameter pipe 	<ul style="list-style-type: none"> • Extension models support deeper and more flexible installations 	<ul style="list-style-type: none"> • Easily removable knock-outs simplify pipe placement and reduce installation time • Two large center knock-outs accommodate up to 3.5" diameter pipe. (Extensions do not have knock-outs) 	<ul style="list-style-type: none"> • Extension models support deeper and more flexible installations 	<ul style="list-style-type: none"> • Easily removable knock-outs simplify pipe placement and reduce installation time • Thirteen large knock-outs accommodate up to 3.5" diameter pipe 	<ul style="list-style-type: none"> • Easily removable knock-outs simplify pipe placement and reduce installation time. Six large knock-outs on the ends accommodate up to 5.0" diameter pipe and 12 knock-outs on the sides accommodate up to 3.0" diameter pipe
MODELS							
<ul style="list-style-type: none"> • VB7RND: 7" Round Body & Green Lid • VB7RNB: 7" Round Body Only • VB7RNBK: Black Lid • VB7RNDGL: Green Lid • VB7RNDPL: Purple Lid 	<ul style="list-style-type: none"> • VB10RND: 10" Round Body & Green Lid • VB10RNB: 10" Round Body Only • VB10RNDL: Green Lid • VB10RNDPL: Purple Lid • VB10RNBK: Black Lid • VB10RNDH: 10" Round Body & Locking Green Lid 	<ul style="list-style-type: none"> • VBSTD: Standard Body & Green Lid • VBSTDH: Standard Body & Locking Green Lid • VBSTDDB: Standard Body Only • VBSTDG: Green Lid • VBSTDPL: Purple Lid 	<ul style="list-style-type: none"> • VBSTD6EXTB: Standard Extension Body Only 	<ul style="list-style-type: none"> • VBJMB: Jumbo Body & Green Lid • VBJMBB: Jumbo Body Only • VBJMBGL: Green Lid • VBJMBPL: Purple Lid • VBJMBH: Jumbo Body & Locking Green Lid 	<ul style="list-style-type: none"> • VBJMB6EXTB: Jumbo Extension Body Only 	<ul style="list-style-type: none"> • VBSPRH: Super Jumbo Body & 2 Lock Green Lid 	<ul style="list-style-type: none"> • VBMAXH: Maxi-Jumbo Body & 2 Lock Green Lid

LOCKING SYSTEMS

- VB-LOCK-H: Hex head 3/8" x 2 1/4" (1.0 x 5.7 cm) bolt, washer, and clip
- VB-LOCK-P: Penta head 3/8" x 2 1/4" (1.0 x 5.7 cm) bolt, washer, and clip





Controllers



Water Saving Tips

- A Seasonal Adjust feature is available on all Rain Bird AC-powered controllers, allowing users to easily adjust irrigation schedules to changing seasonal landscape water requirements. The ESP-LX Series Controllers also feature an automated Monthly Seasonal Adjust feature to help save water through automatic adjustments every month of the year. LNK WiFi Module compatible controllers can be adjusted daily with the Automatic Seasonal Adjustment feature in the Rain Bird App.
- Water savings can also be optimized through daily irrigation schedule adjustments which fine-tune watering based on current weather. All ESP-LX series controllers can easily be upgraded to include smart weather-based/ET or soil moisture irrigation control capability by adding a local rain sensor or soil moisture sensor.
- All Rain Bird controllers simplify conservation through a variety of flexible programming features. With the touch of a button, the ESP-ME3 and ESP-TM2 can recall a previously saved "Contractor Default" irrigation program; the ESP-LX Series "Delayed Recall" feature automatically reverts to typical watering programs after a user-set time period.

Introduction

Spray Bodies

Spray & Rotary Nozzles

Rotors

Valves

Controllers

Sensors & Meters

Central Controls

Drip Irrigation

Pumps & Filtration

Drainage Products

Resources

Major Products	NEW		Wi-Fi READY		Bluetooth		
	Works with iQ4	Works with iQ4	Works with iQ4	Works with iQ4	Works with iQ4	Bluetooth	
Primary Applications	ESP-LXIVM	ESP-TM2	ESP-ME3 ESP-Me	ESP-LXME ESP-LXMEF	ESP-LXD	ESP-9V	TBOS BT
Residential		•	•			•	•
Light Commercial	•	•	•	•	•	•	•
Commercial/Industrial	•			•	•		•
Type of Controller							
Hybrid	•	•	•	•	•		
Solid State						•	•
Battery Operated						•	•
Indoor Location	•	•	•	•	•		
Outdoor Location	•	•	•	•	•		
Features							
Stations (up to)	60/240	12	22	48	200	6	6
Programs (up to)	10/40	3	4	4	4	6	3
Station Timing (up to)	96 hr	6 hr ¹	6 hr ¹	12 hr ¹	12 hr ¹	12 hr	12 hr
Number of Starts per Program (up to)	8	4	6	8	8	6	8
Surge protection	•	•	•	•	•		
230VAC Option	•	•	•	•	•		
Master Valve/Pump Start	• ²	•	•	• ²	• ²	Multi-station models only	
Water Budgeting	• ⁴	•	•	• ⁴	• ⁴	•	•
Individual Program/Zone Shut-Off	•	•	•	•	•		
Rain Delay	•	•	•	•	•		
Mobile App Programmable	•		•	•	•	•	•
Sensor Terminals, Status Indicator and Override	•	•	•	•	•	•	
Delay Between Stations (up to)	0 - 60 min.	9 hrs	9 hrs	0 - 10 min.	0 - 10 min.		
Flow Sensing	•		ESP-ME3 only		• ⁵		
Simultaneous Multi-Station Operation	•			•	•		•
Cycle + Soak™	•		• ⁶	•	•		
Overlapping Programs	•		•	•	•	•	
Manual On/Off	•	•	•	•	•	•	•
Remote Control Compatible	•	•	•	•	•		
Diagnostic Test	•			•	•		
Diagnostic Valve Circuit Breaker	•	•	•	•	•		
Out-of-Valve Box Programming							•
Submersible (up to)						3.3 ft (1 m)	3.3 ft (1 m)
Vandal/Tamper Resistant							•
Self-Cleaning Solenoid							•
Low Battery Indicator						•	•
Save / Restore Programs	•	•	•	•	•	•	•
Master Valve ON/OFF by Station	•	•	•	•	•		•
Total Run Time Calculator by Program	•		•	•	•		•
Bypass Rain Sensor by Station	•	•	•	•	•		
Programming Schedule							
7 Day-of-Week	•	•	•	•	•	•	•
1-7 Variable Cycle	•	•	•	•	•	•	•
1-31 Variable Cycle	•	•	•	•	•	•	•
Odd/Even Cycle	•	•	•	•	•	•	•
Odd 31st	•	•	•	•	•		•
365-Day Calendar	•	•	•	•	•	•	
Event Day Off	•			•	•		
Central Control Compatibility							
iQ™ Upgradeable	•			•	•		
Cabinet							
Plastic-Indoor		•	•				
Plastic-Outdoor	•	•	•	•	•	•	•
Powder-Coated Metal Outdoor	•			•	•		
Stainless Steel Pedestal	•			•	•		
Powder-Coated Metal Pedestal	•			•	•		
Hardware/Accessories							
Two-Wire Devices and Accessories	•				•		
Rain Sensing (need Rain Sensor)	•	•	•	•	•	•	•
Flow Sensing (need Flow Sensor)	•		ESP-ME3 only	ESP-LXMEF only	•		
SMRT-Y Soil Moisture Sensor		•	•				

¹ With water budgeting, timing can be extended ² Programmable by station ³ 6 independent start times per zone ⁴ Selectable for each program and by month ⁵ With Flow Smart Module ⁶ ESP-ME3 only with LNK WiFi Module

ESP-LXIVM and LXIVM Pro 2-Wire Controllers

60/240 Station Capable Two-Wire Commercial Controller



Allows users to control/monitor 1 to 1000s of controllers from their computer or mobile device

Controller Features

- 60-station capability standard expandable to 240 stations with LXIVM Pro Panel
- Four available sensor inputs (one wired plus up to three on 2-Wire path) with override switch. Eight (Seven plus 1) for LX-IVM Pro
- Five flow sensors supported (LX-IVM), Ten for LX-IVM Pro
- Supported Field devices: IVM-SOL, IVM-OUT and IVM Smart Valves
- Supports IVM-SEN sensor devices (flow sensing and weather sensor support) and IVM-SD surge devices (one per 500 feet of two-wire path or every 15 devices required)
- Central Control capable with Rain Bird IQ Communications Cartridges and software (see pg. 106)
- Six user-selectable languages
- 10 independent programs (LX-IVM) or 40 Programs (LX-IVM Pro)
- Removable front panel is programmable under battery power
- Compatible with Rain Bird Landscape Irrigation and Maintenance and Third Party Remotes
- Plastic, locking, UV resistant, wall-mount case, Optional Metal and Stainless Steel Case & Pedestal



ESP-LXIVM Controller

Operating Specifications

- Station timing: 0 min to 96 hrs
- Program level and global Monthly Seasonal Adjust; 0% to 300% (96 hrs maximum station run time)
- 8 start times per program
- Program Day Cycles include Custom days of the week, Odd, Odd no 31st, Even, and Cyclical dates
- Manual station, program, test program

Diagnostic Features

- Alarm light with external case lens
- 2-Wire diagnostics to simplify and expedite troubleshooting
- Four isolated wire paths prevent full system failure under a single short
- 2-Wire Mapping: Maps the devices to corresponding wire paths in the controller to help quickly find and resolve issues
- Trending 12-month electrical history reports and proactive action
- Self-Healing: Automatically detect "fixes" to wire path and splice issues and re-start irrigation without reliance on manual intervention
- Two-Way Communication: with Intelligent Valve Modules (IVM) communication happens both ways enabling key features
- Self-Shutoff : Once loss of power is detected, automatically shutoff valve to avoid leaks

Certifications

- cULus, CE, IPX4. For current certifications visit: www.rainbird.com/esplxivm



ESP-LXIVM and LXIVM Pro 2-Wire Controllers (cont.)

Water Management Features

- Learn Flow utility and flow usage totalizer help optimize water usage
- FloWatch™ protection for high and low flow conditions set by the user FloManager™ manages hydraulic demand, make full use of available water to turn on as many stations as possible without exceeding water supply and reducing the total time to complete irrigation cycles.
- SimulStations™ allows stations to operate at the same time; up to 8 with LX-IVM and 16 with LXIVM Pro
- Cycle+Soak™ by station
- Rain Delay up to 30 days
- 365-Day Calendar Day Off (up to 5 days)
- Station Delay by program
- Normally Open or Normally Closed Master Valves programmable by station; up to 5 with LX-IVM and 10 with LX-IVM Pro
- Optional Weather Sensors are programmable by station to prevent or pause watering; up to 4 with LX-IVM and 8 with LX-IVM Pro
- Seasonal Adjust by Program or by Month

Environmental

- Operating Temperature
 - Operating temperature range: 14°F to 149°F (-10°C to 65°C)
- Operating Humidity
 - Operating humidity range: 95% max at 40°F to 120°F (4°C to 49°C) in a non-condensing environment
- Storage Temperature
 - Storage temperature range: -40°F to 150°F (-40°C to 66°C)
- Upgrade Options
 - IQ-NCC Network Communication Cartridge
 - LXIVM Pro Panels (for regular 60 station controllers)

Electrical Specifications

- Power Supply Voltage: 120 VAC ± 10%, 60Hz
- Power back-up: Lithium coin-cell battery maintains time and date while nonvolatile memory maintains the schedule
- Simultaneous operation of up to eight (IVM) or sixteen (IVM Pro) Stations plus any corresponding master valves

Dimensions (W x H x D)

- 14.32" x 12.69" x 5.50" (36.4 x 32.2 x 14.0 cm)

Model

- ESPLXIVM: Domestic Version 120VC
- ESPLXIVMP: Domestic Version (Pro) 120V

Accessories

- IVM Field Devices* (see next page)
- Painted Metal and Stainless Steel Pedestal/Enclosure Options available (see pg. 95)
- IQ-NCC: Network Communication Cartridge for ESP-LX Series Controllers (see pg. 106)
- See page 98 for information on Rain Bird FS-Series Flow Sensors
- Pump Start Relays (PSR110-IVM or PSR220-IVM)

*IVM Field devices include peel-off barcode address labels

For more information call the ESP-LX Hotline: 1-866-544-1406



LXMMSSPED Shown with ESP-LXIVM in LXMMSS Stainless Steel Cabinet

Field Devices

ESP-LXIVM 2-Wire Field Devices Field Devices are installed along the 2-Wire path to interface with valves and other hardware.

IVM-SOL

- Interfaces with LX-IVM to control station valves and master valves
- Interfaces with PEB, PESB, PGA, EFB-BP and BESP Valves
- Available pre-installed in a SmartValve configuration with PEB and PGA Valves
- Rain Bird WC20 connectors (included) to be used for all splices
- Current Draw: 0.67mA
- Model: LXIVMSOL

IVM-OUT

- Interfaces with LX-IVM to manage 3rd party valves and external gear such as pump stations
- Rain Bird WC20 connectors (included) to be used for all splices
- Current Draw: 0.67mA
- Model: LXIVMOUT

IVM-SEN

- Interfaces with LX-IVM to control weather sensors or flow sensors
- Rain Bird WC20 connectors (included) to be used for all splices
- Current Draw: 6mA
- Model: LXIVMSEN

IVM-SD (Surge Protection)

- IVM-SD provides surge protection on the 2-Wire path
- One every 500ft or 15 field devices
- Rain Bird WC20 connectors to be used for all splices
- Model: LXIVMSD



IVM-SOL



IVM-OUT



IVM-SEN



IVM-SD

Key Specifications

Feature	LX-IVM	LX-IVM Pro
Max Programs	10	40
Stations	60	240
Max Simulstations	8	16 (plus active MV's)
Master Valves	5	10
Flow sensors	5	10
Weather sensors	4	8 (including 1 Local)
Watering windows	1 per program	
Max run time	96 hrs	
Start Times/program	8	
Interstation delay	Up to 1 hour per program	
LCD	2.5"x5" at 127x256 pixels. Monochrome with backlight	
Front Panel Buttons	- All Buttons are back-lit - 5 Programming Button - Dedicated Language, Info and Back Buttons	
Transformer size	1.9 amp (50 VA)	
IVM current draw	720 uA (Standby)	
Sensor current draw	8.4mA (Standby)	
Max wire run	1.65 miles (2.66Km) 14 AWG in Star configuration 6.61 miles (10.63Km) Looped	
No. 2-Wire paths and terminal pairs	4	
Cabinet	Plastic	
FloWatch (flow sensing)	YES - Available Options: Diagnose & Eliminate, Shut Down & Alarm, Alarm Only	
FloManager (flow optimization)	Yes	
Flow Rate	0 to 9999.9 gallons/min. (0.1 gallons/min. resolution)	
Supported Flow Sensors	FS050P, FS075P, FS100P, FS150P, FS200P, FS300P, FS400P, FS100B, FS150B, FS200B, FS350B, FS350SS, Custom	
Surge	20 kV int. - 1 IVM-SD every 500 ft. (or 15 field devices)	
Valve type	DC Latching	
Diagnostics Short Finding	Automatically Detect and Turn Off Wire Path Ability to turn on constant current source for field trouble shooting	
Diagnostics Electrical History	- Daily Values (Last 30 Days) - Monthly Averages (Last 12 Mos.) - Values recorded 11:59 PM daily	
Diagnostics - Field Device Response	List Responding and List Not Responding	
Diagnostics Controller Output	Tracks Current Draw from 2-Wire Path 0.67 mA per IVM-SOL/IVM-OUT 6 mA per IVM-SEN	
Diagnostics Watering Test	Test All Stations 1 to 10 Mins. (per station)	
Central Control Capable	Yes	

LNK WiFi Module

Irrigation System Control from Anywhere

Features

- Upgrades WiFi-ready controllers (ESP-ME3, ESP-Me and ESP-TM2) to make them fully accessible and programmable from iOS or Android compatible devices*
- Operates like a wireless remote control for your irrigation system while onsite or an internet-based monitoring and control system when offsite
- Streamlines and simplifies initial irrigation timer setup and seasonal adjustment
- Instant access allows for real-time system management and timer settings
- Compatible professional app features allow for simple multi-site management and remote diagnostics by landscape professionals
- Built-in mobile notifications provide troubleshooting access, simplify service calls, and warn of freezing conditions when expected
- Automatic weather adjustments provide daily run time changes, saving up to 50% in water
- Superior programming capabilities that are designed to meet the most stringent water restrictions

Specifications

- 2.4 GHz (only) WiFi router compatible with WEP and WPA security settings
- Compatible with iOS 8.0 and Android 6 (Marshmallow) or later mobile devices*
- Operating Temperature: 14° F (-10° C) to 149° F (65° C)
- Storage Temperature: -40° F (-40° C) to 150° F (66° C)
- Operating Humidity: 95% max @ 50° F to 120° F (10° C to 49° C) non-condensing environment

Electrical Specifications

- Input: 24VAC(RMS) 50/60Hz; 55mA max

Certifications

- cULus, FCC Part 15c, ISED RSS-247, IFETEL, CE.
For current certifications visit: www.rainbird.com/lnkwifi

Dimensions

- Width: 1.13" (2.87 cm)
- Height: 1.83" (4.65 cm)
- Depth: 0.48" (1.22 cm)

Model

- LNKWIFI



LNK WiFi Module



ESP-ME3, ESP-Me and ESP-TM2

ESP-TM2 Series Controller

Simple, Flexible, and Reliable for Residential Applications

Features

- Upgradeable for WiFi-based remote monitoring and control via iOS and Android mobile devices (with LNK WiFi Module sold separately).
- Internet-based weather information can be used to make daily adjustments to the irrigation schedule, saving up to 30% in water (with LNK WiFi Module sold separately).
- 4, 6, 8, and 12 station models to meet small or large residential irrigation needs
- Set Permanent Days Off per program to ensure watering never occurs on days when maintenance crews are on site (for Odd/Even/ Cyclic schedules)
- Easy to install indoors or outdoors with pre-installed power cord
- Quick programming in just 3 steps for ease of setup
- 3 available programs with up to 4 start times for each program to meet the needs of varied landscapes
- One-touch manual watering capability for ease of use
- Large back-lit LCD display for improved visibility in low-light and direct sun conditions
- Contractor Default™ allows you to easily save and restore your custom schedule
- Delay Watering up to 14 days and automatically resume watering after the set delay has elapsed
- Bypass Rain Sensor for any station gives you the ability to customize which stations react to a rain sensor
- Seasonal Adjust by program allows you to easily reduce or increase watering by program

Specifications

- Operating Temperature: Up to 149°F (65°C)
- Storage Temperature: -40°F (-40°C) to 150°F (66°C)
- Operating Humidity: 95% max @ 50°F to 120°F (10°C to 49°C) non-condensing environment

Electrical Specifications

- Input required: 120VAC (±10%) @ 60Hz
- Output: 1A at 24VAC
- Master Valve/Pump Start Relay
- External battery back-up not required. Nonvolatile memory permanently saves the current programming and a 10 year life lithium battery maintains the controllers time and date during power outages

Certifications

- cULus, FCC Part 15b, CAN ICES-3(B)/NMB-3(B), NOM-001-SCFI-1993, CE.
For current certifications visit: www.rainbird.com/esptm2

Dimensions

- Width: 7.92 in. (20.1 cm)
- Height: 7.86 in. (20.0 cm)
- Depth: 3.51 in. (9.0 cm)

Models

- TM2-4-120V: 4-station 120VAC
- TM2-6-120V: 6-station 120VAC
- TM2-8-120V: 8-station 120VAC
- TM2-12-120V: 12-station 120VAC

Accessories

- LNKWiFi: LNK WiFi Module for remote control and notification via iOS or Android device
- WR2 Series Wireless Rain + Freeze Sensors
- RSD Series Rain Sensors



ESP-TM2



Look for the WaterSense labeled LNK WiFi Module and a Rain Bird Rain Sensor to improve the water efficiency capabilities of this controller

ESP-ME3 and ESP-Me Series Controllers

The industry's most flexible irrigation controller solution.
Supports up to 22 stations

Features

- Upgradeable for WiFi-based remote monitoring and control via iOS and Android mobile devices (with LNK WiFi Module sold separately).
- Internet-based weather information can be used to make daily adjustments to the irrigation schedule, saving up to 30% in water (with LNK WiFi Module sold separately).
- Large LCD display with easy to navigate user interface
- Master valve/pump start circuit
- Non-Volatile (100 year) storage memory
- Remotely Programmable under 9V battery power (not included)
- Program based scheduling allows 4 individual programs with 6 independent start times per program for 24 total start times
- Watering schedule options: By days of week, ODD calendar days, EVEN calendar days, or Cyclic (every 1 – 30 days) Advanced Features
- Advanced diagnostics and short detection with LED alert
- Contractor Default™ Program Save/Restore saved program(s)
- Rain Sensor bypass by Station
- Delay Watering up to 14 days (applies only to stations not set to ignore Rain Sensor)
- Manual Watering option by program or station
- Seasonal Adjust applied to all programs or individual program
- Adjustable delay between valves (default set to 0)
- Master Valve on/off by station

ESP-ME3 Specific Features

- Built-in flow-sensing capabilities
- Easy to install indoors or outdoors with pre-installed power cord
- Back-lit LCD display for improved visibility in low-light and direct sun conditions

Operating Specifications

- Station timing: 1 minute to 6 hours
- Seasonal Adjust: 5% to 200%
- Max operating temperature: 149°F (65°C)

Electrical Specifications

- Input Required: 120VAC ± 10%, 60Hz
(International models: 230/240VAC ± 10%, 50/60Hz)
- Master Valve/Pump Start Relay
- Operating Voltage: 24VAC 50/60Hz
- Max Coil Inrush: 11VA
- Max Coil Holding: 5VA
 - Idle/Off power draw 0.06 amps at 120VAC
- Power back-up not required. Nonvolatile memory permanently saves the current programming and a 10 year life lithium battery maintains the controllers time and date during power outages.

Certifications

- cULus, FCC Part 15b, CAN ICES-3(B)/NMB-3(B). For current certifications visit: www.rainbird.com/espme, www.rainbird.com/me3



Look for the WaterSense labeled LNK WiFi Module and a Rain Bird Rain Sensor to improve the water efficiency capabilities of this controller

Dimensions

- Width: 10.7" (27.2 cm)
- Height: 7.7" (19.5 cm)
- Depth: 4.4" (11.2 cm)

North America Models (120VAC)

- Controller Base Models
 - ESP4ME1: 4 station indoor model
 - ESP4ME3: 4 station indoor / outdoor model
- Modules
 - ESPSM3: 3 station module
 - ESPSM6: 6 station module (compatible with ESP-ME3 and ESP-ME series controllers only)

Accessories

- LNKWIFI: LNK WiFi Module for remote control and notification via iOS or Android device
- WR2: Wireless Rain + Freeze Sensors
- RSD Series Rain Sensors
- MJ100B Flow Sensor and other wired flow sensors*

*ESP-ME3 only



ESP-ME3 and ESP-Me Series Controller and Modules

ESP-9V Series

Battery-Operated Controller

Features

Controller Features

- Waterproof case ensures long life, even when installed in a valve box
- Common programming features are easily accessed on one screen, making programming quick and easy
- Operates for approximately one full year using one 9-volt alkaline battery, or two years with two 9-volt alkaline batteries
- Large LCD display with easy to navigate user interface
- Sensor input with bypass override
- Mast valve/pump-start circuit (multi-zone units only)
- Non-volatile (100-year) program memory
- IP68 certified for protection against dust and water intrusion
- Plastic controller case has outstanding resistance to weather, yellowing and aging

Scheduling Features

- Dedicated manual watering button for easy operation
- Automatic zone-stacking ensures that only one valve irrigates at the same time. ESP-9V will automatically irrigate the lower number zone first if zones are scheduled to water at the same time
- Contractor Rapid Programming™ automatically copies the start times and watering days from zone 1 to all remaining zones at initial setup
- Run times, start times, and watering days are customizable by zone
- 6 start times per zone
- 4 watering day options per zone: Custom days of the week, Cyclic, and ODD or EVEN calendar days
- Delay watering (1 to 9 days)

Valve Compatibility

- Rain Bird K80920
- Hunter 458200
- Irritrol DCL
- Toro DCLS-P

Controller Dimensions

- Width: 5.35" (13.59 cm)
- Height: 4.04" (10.26 cm)
- Depth: 2.42" (6.15 cm)
- Weight: 2 lbs (907 g)

LCD Screen Size

- Width: 2.25" (5.72 cm)
- Height: 1.25" (3.18 cm)



With optional Wall Mount

Optional Wall Mount Dimensions

- Width: 4.25" (10.76 cm)
- Height: 6.930" (17.60 cm)
- Depth: 1.965" (4.99 cm)
- Weight: 3.6 oz (107 g)

Certifications

- cULus. For current certifications visit: www.rainbird.com/esp9v

Models

- ESP9V1: 1-Zone ESP-9V Controller
- ESP9V2: 2-Zone ESP-9V Controller
- ESP9V4: 4-Zone ESP-9V Controller
- ESP9V6: 6-Zone ESP-9V Controller
- ESP9V1SOL: 1-Zone + 9V Solenoid
- 9VMOUNT: Wall-mount kit



ESP-9V Series
Battery-Operated Controller



TBOS-BT

Bluetooth Battery-Operated Controller.

Install anywhere. Program from a Smartphone.

Features

Rain Bird Mobile App Features for TBOS BT

- Create, review and transmit irrigation programs
- Capability to set zones or programs to manually irrigate
- Basic programming includes 3 independent programs A,B and C, each with 8 start times per day
- Stations can be assigned to several programs with different watering run times
- Run time is from 1 minute to 12 hours in 1-minute increments
- Five watering day cycle modes (Custom, even, odd, odd-31, cyclical) selectable by program for maximum flexibility and watering
- Program and global Monthly Seasonal Adjust; 0% to 300% (1% increments)
- Delay watering from 1 to 14 days
- Built-in ID with naming capability. The control module and stations can be individually named.
- Optional passcode
- Permanently turn the controller off to prevent irrigation
- Battery indicator reports the status of the control module's battery
- Capability to clear the control module's irrigation program

Controller Features

- Operates for approximately one full year using one 9-volt alkaline battery
- Completely potted to obtain IP68 conformity
- Independent station operation allows sequential start times (with stacking in case of overlap) restriction compliance
- Master valve output on TBOS BT1, 2, 4, & 6 Control Modules
- No loss of irrigation program after a battery replacement

Valve Compatibility

- Rain Bird TBOS Potted Latching Solenoid (K80920)
 - DV, DVF, ASVF, PGA, PEB, PESB, EFB-CP, and BPES series
- Hunter 458200
- Irritrol DCL
- Toro DCLS-P

Certifications

- cULus, FCC Part 15b, ISED RSS-247 Issue 2.0, CE, IP68, ICASA, CITC, ACMA, SUBTEL, SRRC, MIC, IFETEL, CRA, TRA.

For current certifications visit: www.rainbird.com/tbosbt

TBOS-BT System Components

Rain Bird Mobile App Features for TBOS BT

- Available for Android and IOS devices

Models

- TBOS-BT1 (1 Station)
- TBOS-BT2 (2 Station)
- TBOS-BT4 (4 Station)
- TBOS-BT6 (6 Station)

Accessories

- K80920 TBOSPSOL: TBOS Potted Latching Solenoid
- RSDBEX: RSD Series Rain Sensors
- Adapter for Non-Rain Bird plastic valves
 - K80510 TBOSADAPP
- Adapter for Non-Rain Bird brass valves
 - K80610 TBOSADAPB



TBOS-BT Bluetooth Battery-Operated Controller and Mobile App



ESP-LXME/F Controllers

Modular - Easily expandable from 8 or 12 stations up to 48 stations with 8- and 12-station modules

Features

- Hot-swappable modules, no need to power down the controller to add/remove modules
- 8- or 12-stations base unit expandable to 48 stations with 8- and 12-Station Modules
- Flow Smart Module™ factory installed (ESP-LXMEF) or field upgradable (ESP-LXME)
- Dynamic station numbering eliminates station numbering gaps
- Master valve/pump start circuit
- Weather Sensor input with override switch
- 6 user-selectable languages
- Standard 10kV surge protection
- Non-Volatile (100-year) program memory
- Front panel is removable and programmable under battery power
- Compatible with Rain Bird Landscape Irrigation and Maintenance Remote
- Plastic, locking, UV resistant, wall-mount case, Optional Metal and Stainless Steel Case & Pedestal

Water Management Features

- Optional Flow Smart Module™ with Learn Flow utility and flow usage totalizer — standard on ESP-LXMEF
- FloWatch™ protection for high and low flow conditions with user defined reactions (requires flow sensor)
- FloManager™ manages hydraulic demand, making full use of available water to shorten total watering time
- SimulStations™ are programmable to allow up to 5 stations to operate at the same time
- Station sequencing by station numbers or station priorities
- Water Windows by program plus Manual MV Water Window
- Cycle+Soak™ by station
- Rain Delay
- 365-Day Calendar Day Off
- Programmable Station Delay by program
- Normally Open or Closed Master Valve programmable by station
- Weather Sensor programmable by station to prevent or pause watering
- Program Seasonal Adjust
- Global Monthly Seasonal Adjust

Operating Specifications

- Station run times: 0 min to 12 hrs
- Seasonal Adjust; 0% to 300% (16 hrs maximum station run time)
- 4 independent programs (ABCD)
- ABCD programs can overlap
- 8 start times per program

- Program Day Cycles include Custom days of the week, Odd, Odd31, Even, & Cyclical dates
- Manual station, program, test program

Electrical Specifications

- Power Supply Voltage: 120 VAC ± 10%, 60Hz (International models: 230 VAC ± 10%, 50Hz; Australian models: 240 VAC ± 10%,50Hz)
- Output: 26.5 VAC 1.9A
- Power back-up: Lithium coin-cell battery maintains time and date while nonvolatile memory maintains the programming
- Multi-valve capacity: Maximum five 24 VAC, 7VA solenoid valves simultaneous operation including the master valve, maximum two solenoid valves per station module

Certifications

- cULus, FCC Part 15b, CAN ICES-3(B)/NMB-3(B), CE, IPX4. For current certifications visit: www.rainbird.com/esplxme-esplxmf

Dimensions

- Width: 14.32 in. (36.4 cm)
- Height: 12.69 in. (32.2 cm)
- Depth: 5.50 in. (14.0 cm)

Models

- ESP8LXME: 8-Station Controller, 120VAC
- ESP12LXMEF: 12-Station Controller with Flow Smart Module, 120VAC
- IESP8LXME: 8-Station Controller for International Market, 230VAC
- FSMLXME: Flow Smart Module for ESPLXME/F Controller
- ESPLXMSM8: 8-Station Module for ESP-LXME/F Controller
- ESPLXMSM12: 12-Station Module for ESP-LXME/F Controller
- ESPLXMEFP: ESPLXME Controller Front Panel Only

Accessories

- Painted Metal and Stainless Steel Pedestal/Enclosure Options available (see page 92)
- IQ Communication Cartridge (see page 106)
- Rain Bird FS-Series Flow Sensors (see page 98)

For more information call the ESP-LX Hotline: 1-866-544-1406



Allows users to control/monitor 1 to 1000s of controllers from their computer or mobile device

ESP-LXME Controller



ESP-LXD Decoder Controller

50 – 200 station capable Two-Wire Decoder Commercial Controller

Controller Features

- 50-station capability standard expandable to 200 stations with optional ESPLXD-SM75 modules
- Four available sensor inputs (one wired plus up to three decoder-managed) with override switch
- Five flow sensors supported
- Supported decoders: FD-101TURF, FD-102TURF, FD-202TURF, FD-401TURF, FD-601TURF
- Supports SD-210TURF sensor decoders (flow sensing and weather sensor support) and LSP-1 line surge protectors (one per 500 feet of two-wire path required)
- Central Control capable with Rain Bird IQ Communications Cartridges and software (see pg. 106)
- Advanced Features From Cycle+Soak™ to Contractor Default Program™, the ESP-LXD offers innovative features proven to cut installation expenses, troubleshooting time and water use
- Program backup and barcode decoder address entry with the optional PBCLXD
- Six user-selectable languages
- Removable front panel is programmable under battery power
- Plastic, locking, UV resistant, wall-mount case, Optional Metal and Stainless Steel Case & Pedestal
- Compatible with Rain Bird Landscape Irrigation and Maintenance Remote - Flow Smart Module™ factory installed or field upgradable
- Plastic, locking, UV resistant, wall-mount case, Optional Metal and Stainless Steel Case & Pedestal

Operating Specifications

- Station timing: 0 min to 12 hrs
- Program level and global Monthly Seasonal Adjust; 0% to 300% (16 hrs maximum station run time)
- 4 independent programs (ABCD); ABC programs stack, ABCD overlap
- 8 start times per program
- Program Day Cycles include Custom days of the week, Odd, Odd no 31st, Even, and Cyclical dates
- Manual station, program, test program

Certifications

- cULus, CE, IPX4. For current certifications visit: www.rainbird.com/esplxd

Works with **iQ4**

Allows users to control/monitor 1 to 1000s of controllers from their computer or mobile device



ESP-LXD Decoder Controller



LXMMSSPED Shown with ESP-LXD in LXMMSS Stainless Steel Cabinet

ESP-LXD Decoder Controller (cont.)

Upgrade Options

- IQ-NCC Network Communication Cartridge
- ESP-LXD-SM75 75-station module
- PBCLXD Programming Backup Cartridge

Electrical Specifications

- Power Supply Voltage: 120 VAC \pm 10%, 60Hz (International models: 230 VAC \pm 10%, 50Hz; Australian Models: 240 VAC \pm 10%, 50Hz)
- Power back-up: Lithium coin-cell battery maintains time and date while nonvolatile memory maintains the schedule
- Multi-valve station capacity: up to 2 solenoid valves per station; simultaneous operation of up to eight solenoids and/or master valves

Dimensions (W x H x D)

- 14.32" x 12.69" x 5.50" (36.4 x 32.2 x 14.0 cm)

Model

- ESP-LXD: 50-station, 120 VAC
- IESPLXD: 50-station for international markets, 230 VAC
- IESPLXDEU: 50-station for Europe, 230 VAC
- IESPLXDAU: 50-station for Australia, 240 VAC

Accessories

- FD-TURF: two-wire decoders (see pg. 94)
- SD-210TURF: two-wire sensor decoder (see pg. 94)
- LSP1TURF: two-wire line surge protection (see pg. 94)
- DPU-210: two-wire decoder programming unit (see pg. 95)
- Painted Metal and Stainless Steel Pedestal/Enclosure Options available (see pg. 95)
- IQ-NCC: Network Communication Cartridge for ESP-LX Series Controllers (see page 106)
- See page 98 for information on Rain Bird FS-Series Flow Sensors

¹FD-TURF decoders include peel-off barcode address labels

²Barcode scanning pen not included – sold separately; Unitech MS100NRCB00-SG recommended (www.ute.com)

For more information call the ESP-LX Hotline: 1-866-544-1406

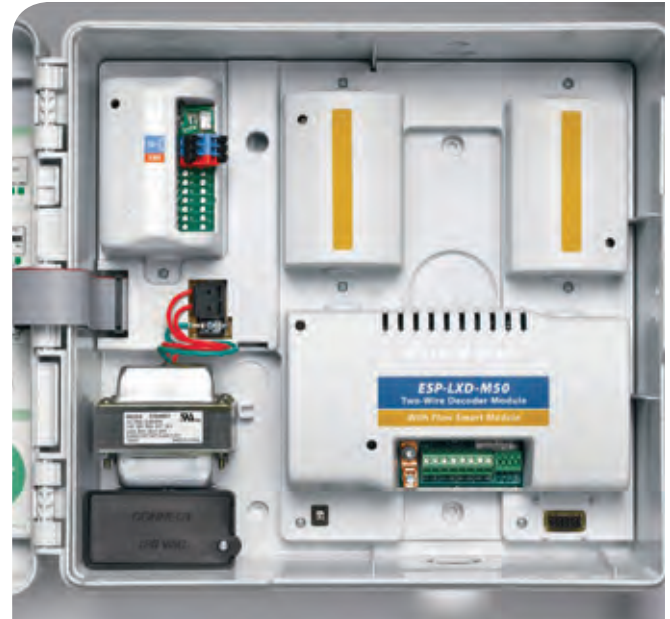

ESP-LXD interior with modules

FD-TURF Two-Wire Decoders

SiteControl and ESP-LXD with Support for 1, 2, 4 or 6 Decoder Addresses

Features

- Five different decoder options let you choose the precise amount of landscape irrigation control you need. Select different two-wire decoders to operate one, two, four, or six valves.
- Installed out of sight and protected from the elements and vandalism
- Enables advanced diagnostic and sensor features

Specifications

- **Mounting:** In valve box (recommended) or direct burial
 - **Power Draw:**
 - FD-101TURF: 0.5 mA (idle) 18 mA (per active solenoid)
 - FD-102TURF: 0.5 mA (idle) 18 mA (per active solenoid)
 - FD-202TURF: 1 mA (idle) 18 mA (per active solenoid)
 - FD-401TURF: 1 mA (idle) 18 mA (per active solenoid)
 - FD-601TURF: 1 mA (idle) 18 mA (per active solenoid)
 - **Dimensions:**
 - FD-101TURF: Length: 2.77 in. (70 mm), Diameter: 1.5 in. (40 mm)
 - FD-102TURF: Length: 3.35 in. (85 mm), Diameter: 1.77 in. (45 mm)
 - FD-202TURF: Length: 3.35 in. (85 mm), Diameter: 1.97 in. (50 mm)
 - FD-401TURF: Length: 3.94 in. (100 mm), Diameter: 2.56 in. (65 mm)
 - FD-601TURF: Length: 3.94 in. (100 mm), Diameter: 2.56 in. (65 mm)
 - **Solenoids:**
 - FD-101TURF: 1 with individual control
 - FD-102TURF: 1 or 2 simultaneously
 - FD-202TURF: 1 to 4 simultaneously
 - FD-401TURF: 1 to 4 with individual control
 - FD-601TURF: 1 to 6 with individual control
 - **Wires:**
 - FD-101TURF: Blue to cable, white to solenoid
 - FD-102TURF: Blue to cable, white to solenoid
 - FD-202TURF: Blue to cable, white and brown to solenoids
 - FD-401TURF: Blue to cable, color-coded to solenoids
 - FD-601TURF: Blue to cable, color-coded to solenoids
 - **Surge Protection: One of the following is required every 500 ft. along two-wire path (40 V, 1.5 kW transil)**
 - LSP-1 Line Surge Protector
 - FD-401TURF with built in surge protection
 - FD-601TURF with built in surge protection
- Note: Minimum 10ohms resistance grounding required at controller and each surge protector*
- **Input Fuse (FD-401TURF and FD-601TURF only):** 300-500 mA, thermal

Electrical Input:

- Maximum voltage: 36 Vpp
- Maximum load:
 - FD-101TURF: 1 Rain Bird solenoid (one per address)
 - FD-102TURF: 2 Rain Bird solenoids (two per address)
 - FD-202TURF: 4 Rain Bird Solenoids (two per address)
 - FD-401TURF: 4 Rain Bird Solenoids (one per address)
 - FD-601TURF: 6 Rain Bird solenoids (one per address)

Decoder/Solenoid Wires:

- Electrical resistance: Max. 3 ohms

Maximum Distance Decoder/Solenoids:

- Cable length: 14 gauge, 456 feet

Wiring: 2 x 14-gauge (1.5 mm²) solid copper, UF insulated type

Environment:

- Working range: 32° to 122° F (0° to 50° C)
- Storage range: -4° to 158° F (-20 to 70° C)
- Humidity: 100%

Note: Rain Bird recommends using Rain Bird DB Series Wire Connectors (pg. 73) waterproof connectors for all connections.

Note: FD-Series Decoders are not compatible with residential valves like the Rain Bird HV, DV, DVF, ASVF, JTV, JTVF, and Drip Control Zone Kit with ASVF/DV valves

Models

- FD-101TURF: Field Decoder interfacing signal line and valve
- FD-102TURF: Field Decoder interfacing signal line and valve or one pair of valves
- FD-202TURF: Field Decoder interfacing signal line and 2 valves or 2 pair of valves
- FD-401TURF: Field Decoder interfacing signal line and up to 4 individual valves
- FD-601TURF: Field Decoder interfacing signal line and up to 6 individual valves
- LSP-1TURF: Line Surge Protection
- SD-210TURF: Sensor Decoder interfacing signal line and analog or digital decoders



Decoders

Controllers

PBC-LXD, Controller Pedestals
DPU-210 Decoder Programming Unit

PBCLXD Programming Backup Cartridge for ESP-LXD

Provides program backup and restore and barcode scanning capability for the ESP-LXD controller (not compatible with ESP-LXME or ESP-LX Basic)

Upgrade Kit Features

- Provides 8 full backups, including all programs, flow information and decoder addresses – allows you to easily archive 8 different controllers – restoring all information typically takes two minutes or less
- Snaps into the back of the ESP-LXD front panel; installs without tools; no additional enclosures or external wiring required
- Kit includes cable for interface to barcode scanning pen (pen not included) – allows you to quickly scan decoder addresses into the ESP-LXD controller during installation to save you time

Model

- PBCLXD (works with all versions of the ESP-LXD controller)



PBCLXD Cartridge

Controller Pedestals

Pedestals for ESP-LX Series, ESP-MC, ESP-SAT, ESP-SITE, and CCU

Features

- Includes all necessary mounting bolts, nuts, and washers

Specifications

- Material: Powder-coated steel and stainless steel
- Field wiring connection: In controller

Dimensions

Model	Height	Width	Depth
• LXMM	12 $\frac{7}{8}$ " (32.7 cm)	14 $\frac{1}{2}$ " (36.8 cm)	7 $\frac{3}{4}$ " (19.7 cm)
• LXMPED	28" (71.1 cm)	14 $\frac{1}{4}$ " (36.2 cm)	7 $\frac{1}{4}$ " (18.4 cm)
• LXMMSS	12 $\frac{7}{8}$ " (32.7 cm)	14 $\frac{1}{2}$ " (36.8 cm)	7 $\frac{3}{4}$ " (19.7 cm)
• LXMMSSPED	28" (71.1 cm)	14 $\frac{1}{4}$ " (36.2 cm)	7 $\frac{1}{4}$ " (18.4 cm)

Model

- LXMM: Metal Cabinet for ESP-LX Series Controllers*
- LXMPED: Metal Pedestal for ESP-LX Series Controllers*
- LXMMSS: Stainless Steel Metal Wall Mount Enclosure for ESP-LX Series Controllers
- LXMMSSPED: Stainless Steel Metal Pedestal for ESP-LX Series Controllers

* **Note:** Metal cabinets and pedestals are not standard on ESP-LX Series controllers and must be purchased separately. LXMPED requires LXMM, and LXMMSSPED requires LXMMSS.



LXMMSSPED Shown with ESP-LXIVM in LXMMSS Stainless Steel Cabinet

DPU-210 Decoder Programming Unit

For ESP-LXD, MDC/MDC2 and SiteControl FD-Turf Two-Wire Decoders

- Decoder Programming Unit tests and verifies operation of the ESP-LXD, MDC/MDC2, or SiteControl FD Series Field Decoders. Also allows for re-programming decoder addresses for maximum site set-up flexibility



DPU-210



- Introduction
- Sprayer Bodies
- Sprayer & Rotary Nozzles
- Rotors
- Valves



Sensors & Meters

- Controllers
- Sensors & Meters
- Central Controls
- Drip Irrigation

Sensors & Meters Compatibility Matrix											
Accessory	Description	ESP9V	TBOSBT	ESPTM2	ESPME	ESPME3	ESPLXME	ESPLXMEF	ESPLXD	ESPLXIVM	ESPLXIVMP
Weather Sensors & Stations											
RSD-BEx	Wired Rain Sensor	•	•	•	•	•	•	•	•	•	•
WR2	Wireless Rain/Freeze Sensor			•	•	•	•	•	•	•	•
SMRT-Y	Soil Moisture Sensor			•	•	•	•	•			
ANEMOMETER	Wind Speed Sensor						• ¹	• ¹	• ¹	• ¹	• ¹
Flow Meters & Sensors											
MJ100B	1" Brass Water Meter					•		•	•	•	•
ICWM	Internet Connected Water Meter										
FS100P	1" PVC Tee Flow Sensor					•		•	•	•	•
FS150P	1-1/2" PVC Tee Flow Sensor					•		•	•	•	•
FS200P	2" PVC Tee Flow Sensor					•		•	•	•	•
FS300P	3" PVC Tee Flow Sensor					•		•	•	•	•
FS400P	4" PVC Tee Flow Sensor					•		•	•	•	•
FS100B	1" Brass Tee Flow Sensor					•		•	•	•	•
FS150B	1-1/2" Brass Tee Flow Sensor					•		•	•	•	•
FS200B	2" Brass Tee Flow Sensor					•		•	•	•	•
FSINSERT	Replacement insert for tee sensors					•		•	•	•	•
FS350B	Insert Flow Sensor					•		•	•	•	•

¹ Requires PT5002 Pulse Transmitter



Water Saving Tips

- Properties managed with a flow sensor averaged 35% savings. As part of a two-year study, historical water usage was compared on eight properties to water usage after a flow sensor was installed.
- By installing a Rain Bird flow sensor and a compatible flow-sensing controller, you can quickly identify leaks, shut down damaged areas and prevent costly flooding to your property. Plus, you can monitor your water efficiency over time.
- With cost-effective flow-sensing technology from Rain Bird, you can help avoid small leaks and big issues—building more trust and a stronger reputation for your business.

Internet Connected Water Meters (ICWM)

Advanced Single-Jet Technology Water Meters

Features

- 5 year data plan works anywhere the Verizon 4G wireless network reaches avoiding costs of network integration
- Digital register with web interface for water usage data collection and analysis including monthly water budgeting and over-usage alerts
- Extreme low flow accuracy starting 0.1 gpm to easily identify leaks
- Wide operating temperature range
- Lead free NSF61 compliant
- Low flow, backflow and high usage reports and alerts
- 5 year data service plan + 5 year warranty included
- Compact design for tight installations with no upstream or downstream straight pipe requirements
- Single moving element and no strainer requirement for low maintenance
- Brass, bronze, cast iron, or composite plastic body for durable, long-lasting performance
- Unaffected by sand or small debris in line
- High resistance to freezing

Certifications

- FM Approved (ICWM600S)
- NSF Standard 61 Compliant
- AWWA C712 Standard



ICWM100S shown. All models include remote antenna



Free ICWM web portal access included

Operating Specifications

Model	Size (in)	Description	Lay Length	Approx. weight w/ register (lbs.)	Initial Wireless Term	Body Material	End Connection	Max Op Press (PSI)	Min Test Flow (GPM)	Normal Op Range		Max Cont. Duty (GPM)	Head Loss @ SMOC (PSI)
										Min (GPM)	Max (GPM)		
ICWM075S	5/8" X 3/4"	5/8" Single-Jet Cellular IC Flow Meter	7.5"	1	5 years	Plastic	1" NPSM	230	0.0625	0.125	30	24	13
ICWM100S	1"	1" Single-Jet Cellular IC Flow Meter	10.75"	5.6	5 years	Low lead Bronze	1.25" NPSM	230	0.125	0.5	70	35	8
ICWM150S	1.5"	1.5" Single-Jet Cellular IC Flow Meter	7.87"	10	5 years	Low lead Brass	Oval Flange	230	0.250	0.500	105	88	7.25
ICWM200S	2"	2" Single-Jet Cellular IC Flow Meter	9.78"	12	5 years	Low lead Brass	Oval Flange	230	0.250	0.75	165	130	7.25
ICWM300S	3"	3" Single-Jet Cellular IC Flow Meter	11.8"	32	5 years	Low lead Brass	3" Flange	230	0.50	0.75	350	175	7.25
ICWM400S	4"	4" Single-Jet Cellular IC Flow Meter	13.75"	48	5 years	Lead free Bronze	4" Flange	230	0.75	1.5	500	350	7.25
ICWM600S	6"	6" Single-Jet Cellular IC Flow Meter	17.75"	89	5 years	Lead free Bronze	6" Flange	230	1.00	2.00	1000	600	9.5

Note: Spool connections are available to adjust lay length.



MJ100B



FS350B



FS200B
FS150B
FS100B



FS150P
FS200P
FS300P
FS400P

FS100P

Flow Meters and Sensors

Compatible with IQ3, IQ4, Maxicom, SiteControl, LINK, Site SAT, ESP- LXD, LXME, LXMEF, ESP-ME3 and LX-IVM Controllers

Features

- Simple six-bladed impeller design
- Designed for outdoor or underground applications
- Available in PVC, brass or stainless steel construction
- Pre-installed in tee or saddle mounted insert versions

Operating Specifications

- Accuracy: +- 1% (full scale)
- Velocity: 1/2-30 feet (0.15 - 9.2 meters) per second depending on model
- Pressure: 400 psi (27.5 bars) (max) on brass models; 100 psi (6.9 bars) (max) on plastic models
- Temperature: 220° F (105° C) (max) on brass models; 140° F (60° C) (max) on plastic models

MJ100B Analog 1" NPT Brass Flow Sensor

- Landscape Flow Sensor with analog register dial readout and wired connection for ESP-ME3 Controller
- Delivers precise accuracy with flow ranges from 1.2 gpm to 50 gpm
- Brass body and glass-filled nylon construction provide maximum protection against high-pressure surges, physical damage, and corrosion

FS Series Impeller Flow Sensors

- FS350B: Brass Insert Sensor
- FS100B, 150B, and 200B: Brass Sensors
- FS150P, 200P, 300P, and 400P: PVC Sensors
- FS100P: Tee Sensor

For complete Controller/Sensor compatibility information, see the Sensors & Meters Compatibility Matrix on page 196

Rain Bird Flow Sensor Suggested Operating Range

The following tables indicate the suggested flow range for Rain Bird Flow Sensors. Rain Bird Sensors will operate both above and below the indicated flow rates. However, good design practice dictates the use of this range for best performance. Sensors should be sized for flow rather than pipe size.

Models and Dimensions

Model	Description	Dimensions
MJ100B	1" Brass Flow Sensor for the ESP-ME3	10.75" x 4.38" x 5.13" (273mm x 111mm x 130mm)
FS100P	1" (25mm) PVC Tee Flow Sensor	3.50" x 3.94" x 1.315" (89mm x 100mm x 33mm)
FS150P	1 1/2" (40mm) PVC Tee Flow Sensor	5.0" x 5.16" x 2.38" (127mm x 131mm x 60mm)
FS200P	2" (50mm) PVC Tee Flow Sensor	5.63" x 5.64" x 2.88" (143mm x 143mm x 73mm)
FS300P	3" (75mm) PVC Tee Flow Sensor	6.50" x 6.83" x 4.23" (165mm x 173mm x 107mm)
FS400P	4" (110mm) PVC Tee Flow Sensor	7.38" x 7.83" x 5.38" (187mm x 199mm x 137mm)
FS100B	1 1/2" (40mm) Brass Tee Flow Sensor	5.45" x 4.94" x 2.21" (138mm x 126mm x 56mm)
FS150B	1" (25mm) Brass Tee Flow Sensor	6.5" x 5.19" x 2.5" (165mm x 132mm x 64mm)
FS200B	2" (50mm) Brass Tee Flow Sensor	4.25" x 8.35" x 2.94" (108mm x 212mm x 75mm)
FS350B	3" and higher, Brass Insert Flow Sensor	7.13" x 3"(diameter) (181mm x 76mm (diameter))
FS1NSERT	Replacement insert for Tee type sensors	

Model	Suggested Operating Range (Gallons / Minute)	Suggested Operating Range (Liters / Minute)	Suggested Operating Range (Cubic Meters / Hour)
FS100P	5.4 - 54	20 - 200	1.2 - 12
FS150P	5 - 100	19 - 380	1.1 - 23
FS200P	10 - 200	40 - 750	2.3 - 45
FS300P	20 - 300	75 - 1130	4.5 - 70
FS400P	40 - 500	150 - 1900	9 - 110
FS100B	2 - 40	7.6 - 150	0.5 - 9
FS150B	4 - 80	15 - 300	1 - 18
FS200B	10 - 100	38 - 380	2.3 - 23
FS350B	Depends on Pipe Type and Size - please reference Flow Sensors tech spec		

Flow Monitors / Pulse Transmitters

The **PT322 Pulse Transmitter** converts a flow sensor's data output and transmits it through the two-wire path to the Site Controller or to the MaxiLink communication board. Designed for use with Maxicom, SiteControl, Link, and SiteSat systems, the PT322 is easily configurable through your computer, providing real-time flow or wind speed data.

The **PT5002 Flow Monitor/Transmitter** is a state of the art instrument, translating flow sensor data or anemometer wind speed data to display instantaneous and total flow/speed in multiple formats, and transmit data to Maxicom and SiteControl Satellite Controller Systems. It also features two high flow cutoff outputs, closing valves and saving water if a pipe or rotor malfunctions, or a high wind speed alert is set. Replacing the PT3002, the new model features a large backlit display and an improved user interface with easy to program functionality.

Features

PT5002 Flow Monitor/Transmitter

- Large, easy to read backlit display
- Simple menu driven soft-key programming
- Pre-programmed Rain Bird flow sensor k-factor and offset selection
- Flow Sensor or Wind Sensor input
- Instantaneous Flow Rate
- Resettable Total Flow
- Hi Flow / High Wind Master Valve Shutoff
- Pulse Decoder output to various controllers and central controls
- Available in two versions:
 - **PT5002 Panel Mount Kit** I/O terminal connectors, mounting hardware, and 24v power supply included
 - **PT5002NEMA Wall Mount Kit** Weatherproof NEMA enclosure, I/O terminal connectors, mounting hardware, and 24v power supply included

PT322 Pulse Transmitter

- Reliable Solid State design
- Compact, easy to mount
- Secure snap fit connectors
- Two diagnostic Status LEDs
- Programmable from Laptop or Computer

Operating Specifications

- Input required: -12-30 VDC/VAC on PT322-12-24 VAC/VDC on PT5002
- Output: Pulse output
- Operating Temp: -4° F-158° F (-20° C to 70° C)

Configuration

- **For ESP-LXD Decoder Systems**, the Flow Sensor is installed with a Two-Wire Decoder Sensor Decoder (SD210TURF)
- **For ESP-LXMEF Systems**, the Flow Sensor is attached to the FSM-LXME Flow Smart Module
- **For ESP-ME3 Controllers**, the Flow Sensor is attached to flow sensor terminals in the controller
- **For (Hard Wire) Two-Wire Satellite Systems (Maxicom² and SiteControl)**, the Flow Sensor is installed with a Pulse Transmitter and a Rain Bird Pulse Decoder (DECPULLR)
- **For Link Radio Satellite Systems (Maxicom² and SiteControl)**, the Flow Sensor is installed with a Pulse Transmitter (no pulse decoder required)
- **For ESP-SITE Satellite Systems (Maxicom²)**, the Flow Sensor is installed with a Pulse Transmitter (no decoder required)
- **For SiteControl Decoder Systems**, the Flow Sensor is installed with a Two-Wire Decoder Sensor Decoder (SD210TURF)
- Surge protection (FSSURGEKIT) is recommended for Maxicom & SiteControl systems – One at the Pulse Transmitter, and if more than 50' of wire run, one at the Flow Sensor. FSSURGEKIT is not compatible with ESP-LXMEF and ESP-LXD Controllers



PT5002 Panel Mount Flow Monitor



PT5002 Wall Mount with NEMA enclosure



PT322



FSSURGEKIT

Compatibility Matrix

Product	Description	ESP9V	TBOSBT	ESPTM2	ESPME	ESPM3	ESPLXME	ESPLXMEF	ESPLXD	ESPLXIVM	ESPLXIVMP	
PT322	Pulse Transmitter Flow											
PT5002	Flow Monitor/Pulse Transmitter Flow											
PT322	Flow Monitor/Pulse Transmitter Wind						●	●	●	●	●	
		IQ with					Maxicom with	Maxicom CCU with		SiteControl TWI with		SiteControl with
		ESPLXME	ESPLXMEF	ESPLXD	ESPLXIVM	ESPLXIVMP	ESPSITE	ESPSAT2	ESPSATL	ESPSAT2	ESPSATL	LDI
PT322	Pulse Transmitter Flow/Wind						●	●*	●	●*	●	●
PT5002	Flow Monitor/Pulse Transmitter Flow/Wind						●	●*	●	●*	●	●

* Requires DECPULLR Decoder for Flow Sensor Input

RSD-BEx

Wired Rain Sensor

Features and Benefits

- Automatic rain shutoff prevents overwatering due to natural precipitation
- Robust, reliable design reduces service call backs
- Moisture sensing disks work in a variety of climates
- Different sensor mounts permit speed and flexibility on the job site
- Latching hinge maintains alignment

Mechanical Properties

- Multiple rainfall settings from 1/8" - 3/4" (5 - 20 mm) are quick and easy with just the twist of a dial
- Adjustable vent ring helps control drying time
- High-grade, UV resistant polymer body resists the elements
- Comes with 5" latching aluminum bracket
- Not compatible with ESP-SMT or ESP-SMTe controllers

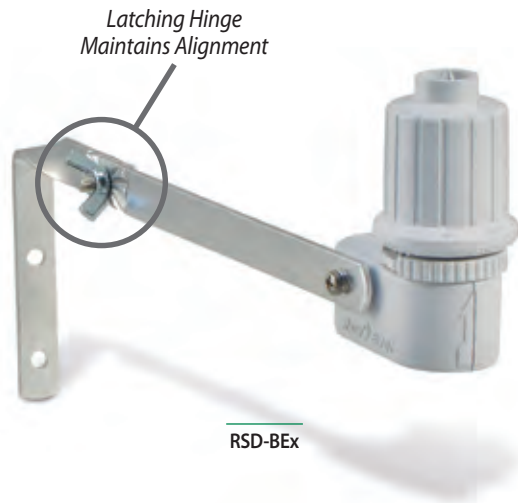

Electrical Specifications

- Application: Suitable for low voltage 24 VAC control circuits and 24 VAC pump start relay circuits*
- Switch electrical rating: 3A @ 125/250 VAC
- Capacity: Electrical rating suitable for use with up to ten 24 VAC, 7 VA solenoid valves per station, plus one master valve
- Wire: 25' (7.6 m) length of #20, 2 conductor UV resistant extension wire

* Not recommended for use with high voltage pump start, pump start relay circuits or devices.

Certifications

- cULus, CE, RCM. For current certifications visit: www.rainbird.com/rsd

Dimensions

- Overall length: 6.5" (16.5 cm)
- Overall height: 5.4" (13.7 cm)
- Bracket hole pattern: 1.25" (3.2 cm)

Model

- RSD-BEx: Rain sensor w/ latching bracket, extension wire

How to Specify

RSD - BEx

Extension Wire
25' (7.6 m) length

Mounting
BE: Metal Bracket

Model
RSD: Rain Sensing Device

ANEMOMETER Wind Sensor

Maxicom², SiteControl, IQ[™], ESP-LXME, ESP-LXD, ESP-LXIVM, ESP-LXIVM Pro

Features

- Accurate wind speed measurement for high-wind shutdown or interrupt of irrigation programs
- Heavy-duty metal mounting bracket
- Requires PT322 or PT5002 Pulse Transmitter for use with Maxicom² System
- Requires PT5002 Pulse Transmitter for use with SiteControl, IQ Systems, ESP-LXME, ESP-LXD, ESP-LXIVM, ESP-LXIVM Pro

Model

- ANEMOMETER



WR2 Series Wireless Rain + Freeze Sensors

Superior responsiveness to rainfall and cold temperatures, save up to 35% on water usage

Features & Benefits

- Enhanced antenna array provides superior signal reliability that overcomes most line-of-sight obstructions
- Sensor signal strength indicator enables one person set up, reducing installation time
- Convenient adjustment and monitoring of rain or freeze settings at the controller interface
- Simple battery replacement without the need to disassemble the sensor
- Highly intuitive icon-driven controller interface simplifies programming
- Easy to install, self-leveling sensor bracket mounts to flat surfaces or rain gutters
- Antennas concealed within the units for greater visual appeal and product robustness
- "Quick Shut Off" interrupts active irrigation cycle during a rain event

Electrical Specifications

- Application: suitable for use with 24 VAC controllers (with or without pump start / master valve)
- Electrical rating suitable for use with up to six 24VAC 7VA solenoids plus an additional master valve or pump start that does not exceed 53VA
- Controller Interface Wire: 30" (76 cm) length of #22 gauge (0.64 mm) UV resistant extension wire
- FCC approved spread spectrum 2 way radio transceivers with FCC Class B approvals
- Signal transmission distance of 700' (213.4 m) Line of Sight
- Battery life: four or more years under normal operating conditions
- 6 KV surge / lightning protection

Certifications

- cULus, FCC Part 15c, ISED RSS-210, CE.
For current certifications visit: www.rainbird.com/wr2

Mechanical Properties

- Adjustable rainfall settings from 1/8" – 1/2" (3 – 13 mm)
- Adjustable low temperature settings from 33°F – 41°F (0.5° – 5°C)
- Three irrigation modes to select: Programmed, Suspend Irrigation for 72 hours, Override sensor for 72 hours

Note: The WR2-48 model replaces the Suspend Irrigation for 72 Hours mode with 48-Hour Irrigation Hold Active mode.

- "Quick Shut Off" suspends active irrigation cycle within approximately two minutes
- High-grade, UV resistant polymer units resist harmful environmental effects

Models

- North America (916 MHz)
 - WR2-RFC: Rain + Freeze Combo
 - WR2-48: Rain + Freeze Combo with 48-hour hold
- International (868 MHz)
 - WR2-RFC-868: Rain + Freeze Combo



Step 1



Program in seconds

Step 2



Determine best sensor location

Step 3



Install sensor easily using mounting bracket

SMRT-Y Soil Moisture Sensor Kit

Accurate • Reliable • Smart

Features and Benefits

- Turns any controller into a water saving smart controller
- Healthier landscapes less prone to nutrient depletion, fungus and shallow root growth
- Typical water savings exceed 40%
- TDT digital sensor enables highly accurate readings that are independent of soil temperature and electrical conductivity (EC)
- Displays soil moisture content, soil temperature and EC
- Corrosion-resistant in-ground sensor made of high-grade 304 stainless steel

Operating Specifications

- 25 Volts AC at 12W
- Operating temperature: -4°F to 158°F (-20°C to 70°C)
- Survival temperature: -40°F to 185°F (-40°C to 85°C)

Certifications

- cULus, FCC Part 15b, CE.
- For current certifications visit: www.rainbird.com/smrty

Dimensions

Controller Interface

- W: 3.0" (76mm); H: 3.0" (76mm); D: 0.75" (19mm)

In-Ground Soil Moisture Sensor (without wires)

- W: 2.0" (50mm); L: 8.0" (200mm); D: 0.5" (12mm)
- 18 AWG wire leads @ 42 in. (106.7 cm) length

SMRT-Y Kit

Includes

- Controller Interface
- In-Ground Soil Moisture Sensor
- Anodized, rust-proof screws, 1.5" (two per package)
- Wire nuts – 5 blue, 2 gray, 1 yellow
- Multilingual instruction manual, "Quick Start" Guide and Soil Moisture sticker

Models

- SMRT-Y: Soil Moisture Sensor Kit

Note: All SMRT-Y models are RoHS compliant

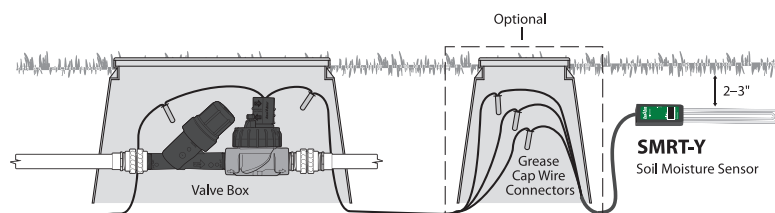
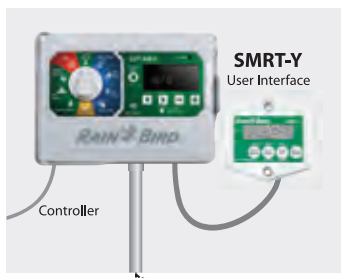
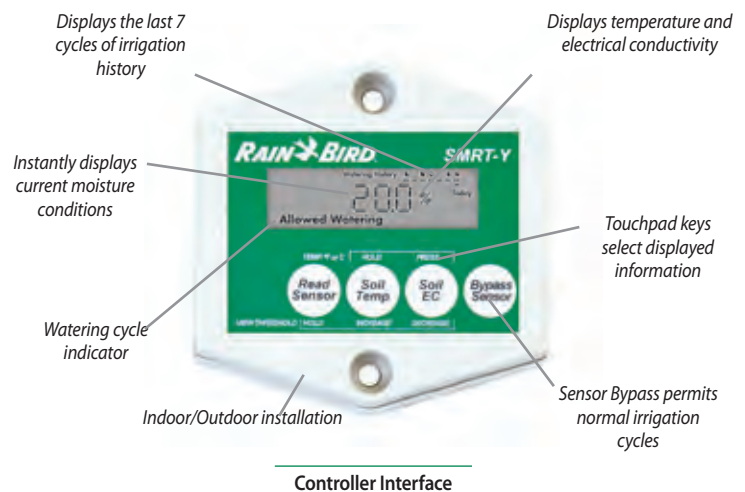
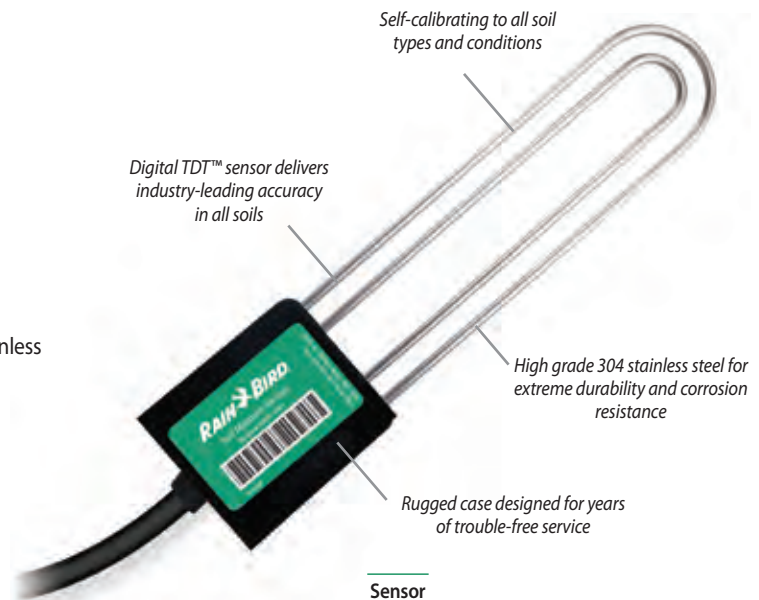

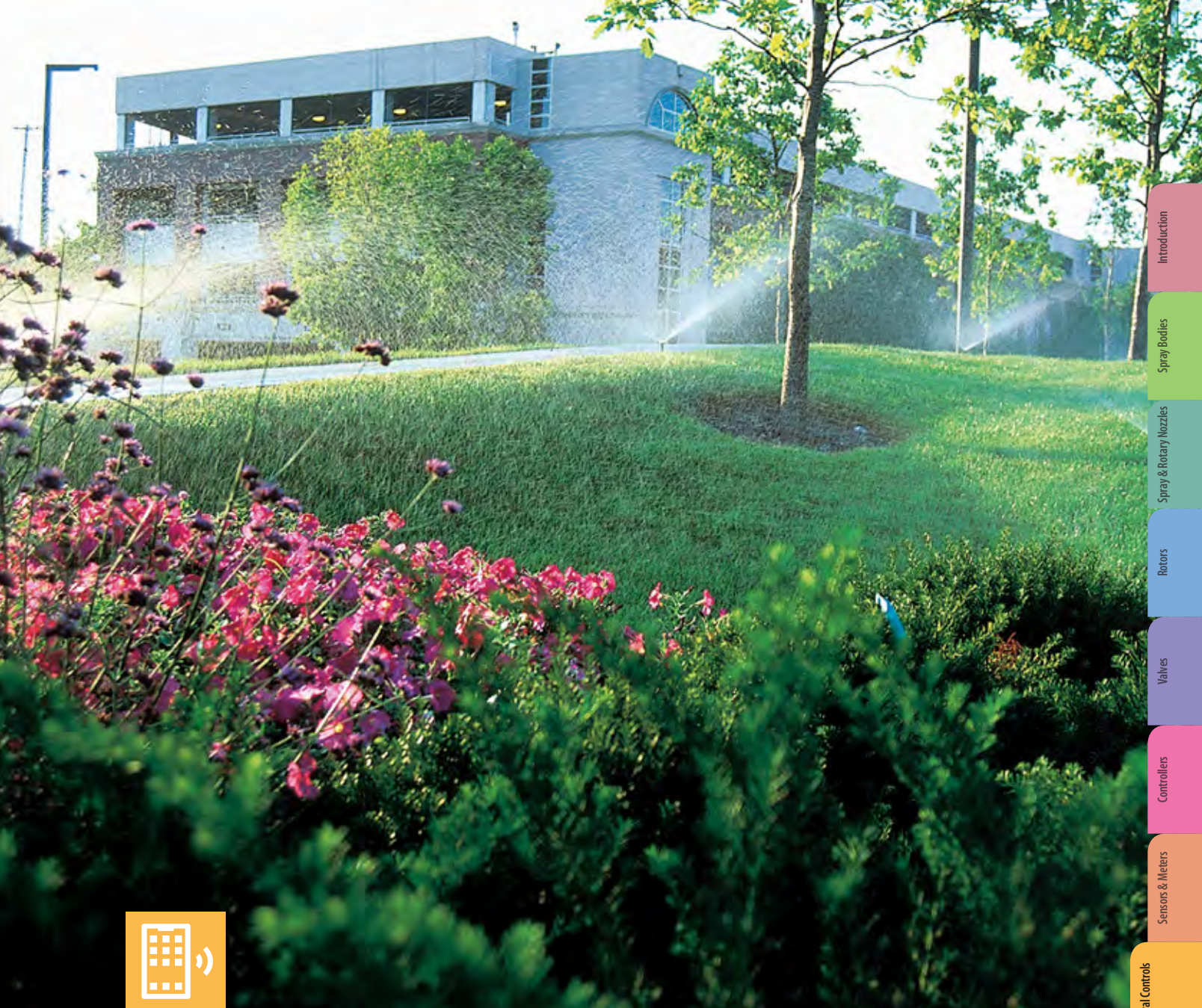

Introduction

Spray Bodies

Spray & Rotary Nozzles

Rotors

Valves

Controllers

Sensors & Meters

Central Controls

Drip Irrigation

Pumps & Filtration

Drainage Products

Resources

Central Controls



Water Saving Tips

- Maxicom², SiteControl, and IQ™ Systems provide fully-automated ET (evapotranspiration) adjustment of irrigation programs for maximum water savings.
- Maxicom² and IQ™ FloWatch™ utility monitors and records real-time flow and automatically diagnoses and eliminates flow problems caused by broken pipes, vandalism or stuck valves.
- The Rain Bird® IQ™ Platform. The ultimate tool for remote water management. With no hidden fees, it's the perfect remote water management solution. With the new IQ4-Cloud software, you can control your irrigation system from any device, anywhere with all the features of the full system. With set up that takes less than five minutes, multi-user access and no recurring annual fees, you finally have the option you've been waiting for.

Join the IQ Movement! Visit www.rainbird.com/products/iq4 and take control now.

Major Products

System Name	IQ4 - Cloud		SiteControl	Maxicom®
System Type	Modular multi-site central control system		Modular single site central control system	Multi-satellite central control system
Traditionally wired or two-wire decoder	Works with both		Works with both	Traditionally wired
Typical applications	Multi-site management with modular features. Ideal solution for water managers, schools, parks, corporate campuses and transportation departments		Single site management with modular features. Ideal for large resorts, cemeteries, shopping centers, theme parks and sports stadiums	Multi-site commercial or industrial irrigation applications. Ideal for municipalities, school districts, homeowner associations and park and recreation departments
Number of sites/system	1000+		1	200+
Local and/or remote site control	Local and remote		Local	Local and remote
Maximum number of simultaneous stations per site/system	5 per ESP-LXME 8 per ESP-LXD	8 per ESP-LXIVM 16 per ESP-LXIVM Pro	3,584 per site	112 per CCU
Number of ET (weather) sources	100		4	16
Program adjustments by ET	Yes		Yes	Yes
Program adjustments by percentage	Yes		Yes	Yes
Programming by volume/gallons	No		No	Yes
Number of programs	4 per ESP-LXME 4 per ESP-LXD	10 per ESP-LXIVM 40 per ESP-LXIVM Pro	100 total per system	999 per CCU
Flow management capabilities	Yes		Yes	Yes
Flow monitoring/recording capabilities	Yes		Yes	Yes
High-flow shutdown	Mainline and laterals		Mainline only	Mainline and laterals
Low- or zero-flow shutdown	Mainline and laterals		No	Mainline and laterals
Alarms/warnings	Yes		Yes	Yes
Sensor input and manual bypass	Yes		Yes	Yes
Number of weather sensor inputs	1 per ESP-LXME 4 per ESP-LXD	4 per ESP-LXIVM 8 per ESP-LXIVM Pro	Up to 200 sensor inputs per system	Up to 56 per CCU
Number of flow sensor inputs	1 per ESP-LXME 5 per ESP-LXD	5 per ESP-LXIVM 10 per ESP-LXIVM Pro	Up to 200 sensor inputs per system	Up to 6 (two wire) or 20 (Link) per CCU
Software/password log-on protection	Yes		N/A	Yes
Remote control capabilities	Yes		Yes, Freedom System	Yes, Freedom System
Cycle+Soak™	Yes		Yes	Yes
Water window by program/schedule	Yes		Yes	Yes
Computer included with software	No		Yes	Yes
Computer programming	Yes		Yes	Yes
24/7 system monitoring	Yes, by the controller		Yes, by the computer	Yes, by the CCU
24/7 communication & feedback	No		Yes, computer to satellites and decoders	CCU to satellite
Remote site telephone, cellular, radio, Ethernet, Wi-Fi communication	All		No	All
Automatic remote site communication	Yes		No	Yes
Satellite controllers or decoders	ESP-LXME ESP-LXD	ESP-LXIVM ESP-LXIVM Pro	ESP-SAT Satellites or FD-Series Decoders	ESP-SAT or ESP-SITE Satellites
Modular station capacity	ESP-LXME: 8-48	ESP-LXD: 50-200	No	No
Number of site/system interfaces	N/A - No interfaces required		8	>200
Number of satellites/system	16,000+		896	>5,600
Number of satellites/site interface	Up to 150 satellites per IQNet		Up to 112 per TWI	Up to 28 per CCU
Number of satellite stations/site	ESP-LXME: Up to 7,200 per IQNet ESP-LXD: Up to 30,000 per IQNet ESP-LXIVM: Up to 9,000 per IQNet ESP-LXIVM Pro: Up to 36,000 per IQNet		Up to 21,504 per system	Up to 672 per CCU
Number of decoder addresses per site	Up to 30,000 per IQNet		Up to 4,000	N/A
Interactive map interface	No		Yes	No
GPS, CAD, SHP, BMP Import	N/A		Yes	BMP, PDF, JPEG
Valve control: stations or decoders	Both		Both	Satellite stations only
Estimated/actual water use report	Yes		Yes	Yes
Event recording (station operation)	Yes		Yes	Yes
Projected operation (dry/run) capability	Yes		Yes	Yes
Supported by Global Services Plan	Yes		Yes	Yes
Can also manage lighting and security systems	Yes		Yes	Yes

IQ4 Central Control Software

Modular Multi-Site Central Control

The IQ Platform offers state-of-the-art command and control features in an easy to learn and use interface. IQ provides advanced water management features saving money and time.

Applications

All IQ versions provide remote programming, management, and monitoring of ESP-LX Series Controllers from the computer in your office. IQ is the perfect irrigation control solution for parks departments, school districts, property managers, landscape maintenance contractors, and water managers. IQ can manage small single-controller sites as well as large multi-controller sites and supports both ESP-LX Series traditionally-wired and 2-wire controllers.

IQ-Cloud is a cloud based service allowing users to login and control their irrigation system from any internet connected device including desktop computers, tablet computers and mobile smartphones.

IQ-Cloud is ideal for organizations with multiple irrigation system administrators and/or users that require mobility. IQ-Cloud features the ability to use mobile devices providing quick access to all IQ4 features in an interface designed for touchscreen devices found in smartphones or tablets. Users are not restricted to an initial capacity and can add satellites at will. Internet access is required.

IQ Platform Software Features

- Compatible with ESP-LXME, ESP-LXIVM and ESP-LXMEF traditionally-wired and ESP-LXD two-wire decoder controllers
- Programming in seconds, minutes, and hours
- ET station run time adjustments by site
- Detailed logs and reports
- Automated satellite Synchronize & Retrieve Logs
- Satellite Two-Way Programming (changes made at the satellite can be viewed and accepted in the IQ4 software)
- Auto-Synchronization of data from IQ to Satellite
- Software uses Irrigation Association terminology and formulas
- IQ Global Weather Internet Service which provides local weather data including rain fall
- Retrieves minute-by-minute flow logs from flow sensor equipped ESP-LXMEF, ESP-LXIVM and ESP-LXD Satellite Controllers
- Flow Logs vs. Projected Flow Graphical Report (identifies which programs & stations where running at any point in time)
- User selectable languages include English, Spanish, French, German, Italian and Portuguese

Visit www.rainbird.com/products/iq4 to learn more about the features included in the IQ4 Platform.

Additional 5-Satellite Capacity Upgrade (IQ-Desktop/Enterprise)

- IQ Software satellite controller capacity can be upgraded in 5-satellite increments
- Additional capacity is added through a purchased software activation Keycode

Recommended Computer Requirements for IQ-Desktop

- Windows 10, Windows 8, Windows 7 Service Pack 1
- Intel I5-540M or equivalent processor
- 8 GB RAM (minimum)
- 10 GB available disk space
- 1024 x 768 pixel screen resolution
- Internet Access
- Chrome (recommended), Edge, or Firefox browser
- Network Connection (for Ethernet, WiFi, Cellular)
- Serial Port or USB to Serial Adapter (for Direct Connect and External Modem communication)

iQ4



How to Specify

IQ4 SOFTWARE

IQ4-Cloud: IQ4 cloud-based software compatible with all Rain Bird ESP-LX controllers with NCC communications cartridges

IQ NCC Network Communication Cartridge

Upgrades any ESP-LX Series Controller to an IQ Central Control Satellite Controller

Features

- IQ is the perfect irrigation control solution for parks departments, school districts, property managers, landscape maintenance contractors and water managers. IQ can manage small single-controller sites as well as large multi-controller sites. IQ NCC cartridges are compatible with the ESP-LXME Controller with 1 to 48-station capacity, ESP-LXD Decoder Controller with 1 to 200-station capacity, ESP-LXIVM Controller with 1 to 60-station capacity and ESP-LXIVM Pro with 1 to 240 station capacity
- IQ NCC cartridges are initially configured through a setup wizard provided in the ESP-LX Series Controller IQ Settings dial position. Communication setting parameters are configured through the IQ software or the NCC Configurator Software designed for netbook/laptop use on the job site

Direct Satellites

- Single controller sites would use an IQ NCC cartridge configured as a Direct satellite. A Direct satellite has an IQ central computer communication connection but no network connections to other satellites in the system

Server & Client Satellites

- Multi-controller sites would use one IQ NCC cartridge configured as a Server satellite and the other NCC cartridges configured as Client satellites. The Server satellite has an IQ central computer communication connection and shares this communication connection with the Client satellites through high-speed data cable or radios. The communication connection between Server and Client satellites is called the IQNet™
- Satellites on a common IQNet can share weather sensors and master valves
- Server and Client satellites using high-speed data cable for IQNet communication require installation of an IQ CM Communication Module. Server and Client satellites using radio communication for IQNet communication require installation of an IQSSRADIO radio. Each cartridge kit includes cables to connect the NCC cartridge to connection module and/or radio

IQ NCC 4G Cellular Cartridge

- Includes embedded 4G Cellular Data Modem with antenna connector
- Includes internal antenna for plastic controller enclosures (optional 4G external antenna available for metal case controller enclosures)
- Requires 4G Cellular data service plan purchased from Rain Bird with cellular service included
- Used for Direct or Server Satellite applications requiring wireless Cellular communication with the IQ central computer
- Available with 1st year of communication service included.
- 4G Cartridge with included communication service not offered in all areas

IQ NCC-EN Ethernet Cartridge

- Includes embedded Ethernet Network Modem with RJ-45 port
- Includes RJ-45e patch cable (requires LAN network static IP address)

IQ NCC-RS RS232 Cartridge

- Includes RS-232 Port for IQ Direct Cable or External Modem communication connection to the IQ central computer, and external modem cable (IQ Direct Cable provided with IQ Software Package)
- Used for Direct or Server Satellite applications requiring direct cable connection or external modem (radio or other 3rd-party device) communication with the IQ central computer, and for Client Satellite applications requiring IQNet high-speed data cable or radio communication with the Server Satellite

IQ FSCM-LXME Flow Smart Connection Module

- Provides IQNet high-speed data cable connections for ESP-LXME Controller
- Includes Flow Smart Module and Base Module functions
- Replaces standard ESP-LXME Base Module

IQ CM-LXD Connection Module

- Provides IQNet high-speed data cable connections for ESP-LXD Controller
- Installs in ESP-LXD 0 (zero) module slot

IQ SS-Radio Radio Modem

- Provides IQNet wireless radio communication between Server and Client satellite controllers
- Can also be used with the IQ NCC-RS RS232 Cartridge for IQ central computer to Direct or Server satellite radio communication
- Includes power supply and external antenna (programming software and cable provided separately)



LX Series Cartridge Panel with IQ-NCC-RS Cartridge Installed

SiteControl

A Full-Featured Central Control System for Single Site Applications

Features

- Advanced Graphical Tracking- Maps generated by GPS technology or AutoCAD recreate your site. Interactive mapping and on-screen graphics show your complete site with location of individual valves and sprinklers allows you to measure and calculate areas from your map
- Smart Weather™ is designed to take complete advantage of Rain Bird's most advanced line of weather stations, tracks ET and rainfall via a weather station and reacts to current weather conditions based on user-defined options. Advanced warning system accepts user-defined sensor thresholds. System operator is immediately alerted if thresholds are exceeded
- RainWatch™ uses tipping bucket rain can(s) to detect and suspend irrigation while measuring rainfall. When rain stops, irrigation resumes with run times reduced according to measured rain
- Minimum ET- allows setting minimum ET threshold values for irrigation to take place. Promotes deep watering for optimum turf conditions
- Automatic ET automatically adjust run times in relation to fluctuations in Evapotranspiration (ET) values
- Remote System Control allows you to take control of your system and operate SiteControl from anywhere on your site using the Rain Bird FREEDOM System. Phone (landline or cellular) or radio communication options
- Hybrid System operates Satellite Controllers and/or Two-Wire Decoders
- SiteControl Plus operates four Large Decoder Interfaces (LDI), each capable of operating up to 1,000 solenoids with Hybrid system, can further expand capabilities by combining Two-Wire Decoder and/or Satellite Controller options up to four total interface devices

Superior Monitoring and Scheduling

- Flo-Graph™ allows visibility of real-time graphics with individual station information presented in colorful charts
- Flo-Manager™ balances system demands and maximum capacities with efficiency helping to lower water demand, reduce system wear and tear and save energy
- Cycle + Soak™. Better control the application of water on slopes and in areas with poor drainage
- QuickIRR™ Quick and easy method to build irrigation schedules and programs based on your parameters

Other Features

- Up to 200 points of connection
- Up to 200 pulse sensors
- Water usage logs
- Station run-time logs
- Posted and dry run logs
- ET spreadsheet
- 1 year Global Service Plan included

Models

- SCON: Desktop PC with SiteControl software, includes 1 year Global Support Plan (GSP)

Software Module Options

- Smart Weather
- Rain Bird Messenger (for Smart Weather)
- Automatic ET
- Hybrid Module
- Smart Sensor
- Map Utilities
- Freedom
- 8 Additional Locations
- Additional Wire-Path (2nd)
- Additional Wire-Path (3rd)
- Additional Wire-Path (4th)
- SiteControl Plus
- Smart Pump
- MI (Mobile Interface)

Global Service Plan (GSP)

- Visit rainbird.com/gsp/index.htm for more information.



SiteControl

SiteControl Hardware

TWI Satellite Interface

- Allows real-time, two-way communication between SiteControl Central Controller and field satellites
- Allows use of advanced in-field capabilities of ESP-SAT twowire or LINK versions
- Modular capacity can grow with the site

Two-Wire Decoder Interface

- Allows real-time, two-way communication between SiteControl Central Controller and decoders
- Connects the powerful capabilities of SiteControl with the ease of installation and security of a two-wire decoder system
- System can be set up and expanded according to project needs

ESP-SAT Satellite Controller

- 40 Stations Satellite Controller
- Field Satellite Controller for Maxicom² or SiteControl Central Control systems
- The power of an advanced water-management tool, in an easy-to-use package
- All the features and stand-alone capabilities of the Rain Bird ESP-MC Controller line

Spread Spectrum Radio

- Frequency hopping to avoid interference
- Reduced cost of ownership, no FCC license required
- No FCC restrictions on antenna height (User should check local laws)
- Radios can be set up as repeater to achieve great distances and overcome obstacles

Ethernet Devices

- Use Ethernet networks to:
 - - Communicate from Central Control Computer to CCUs, SiteSats, TWIs and weather stations
 - - Communicate from CCU and TWIs to ESP-Sats

WS-PRO Weather Stations

- Scientific accuracy sensors located three meters above the ground for added vandal-resistance
- Powerful, internal micro-logger for climatic data collection, logging and analysis, constant communication with weather sensors, and storage of 30 days of data
- Rugged yet lightweight metal construction;

Sensor-Pulse Decoders

- Complete feedback system
- Extends central control system versatility
- Color-coded wire leads for ease of installation
- Programmable address codes for individual operation

RAINGAUGE Rain Sensor

- Accurate rain counter switch counts rainfall in 1/100th inch increments
- Heavy-duty metal construction
- Mounting bracket
- Debris screen

ANEMOMETER Wind Sensor

- Accurate wind speed measurement for high-wind shutdown or interrupt of irrigation programs
- Heavy-duty metal mounting bracket
- Requires PT322 or PT5002 Pulse Transmitter/Monitor for use with Maxicom² System

Maxi Interface Boards

- Upgrades an ESP-MC Controller (wall mount or pedestal) to an ESP-SAT Satellite Controller
- No additional enclosures or external wiring required
- Installs on stand-offs on controller output board

MSP-1 Surge Protection

- Protects central control components from electrical surges on a two-wire communication path
- Can be installed in satellite or CCU pedestal or in valve box in conjunction with MGP-1 (Maxicom² Grounding Plate)

MGP-1 Surge Grounding Plate

- Provides a mounting location for MSP-1 or other grounding wires directly to a grounding rod or pipe
- Installed on grounding rod or pipe



TWI Interface



ESP-SAT Satellite Controller

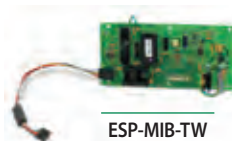

ESP-MIB-TW



DEC-SEN-LR DEC-PUL-LR

Maxicom[®] version 4.5 now available

Multi-Site Central Control Ideal for Large Commercial Systems

Features

- Windows 10 compatibility
- Seek & Eliminate Low Flow (SELF) – Automatically diagnose a low flow problem
- Station Lockout – Quarantine zones that have had high/low flow alarms until the user takes action
- Station Priorities for Flow Manager – allows the user to alter the sequence of irrigation zones by assigning priorities when flow manager is being used
- Queued irrigation max run time limit increased from 99 minutes to 999 minutes
- Adjustable rain can settings
- Seek & Eliminate Excessive Flow (SEEF) improvement to account for manual adjustments
- Database trim setting is no longer fixed and is user-selectable so users can decide how far back the records go
- Phone number/address field works with URL's and longer IP Addresses
- Field Device Configuration Report now includes satellite names and sensor names
- More robust database format (SQL Server)

System Features

- Maxicom²[®] Central Controller Package comes with Maxicom² software, pre-configured computer, Global Service Plan (GSP), and training
- Control hundreds of ESP-SITE-SAT Satellites (single controller sites) and Cluster Control Units (CCUs) which can each control up to 28 individual ESP-SAT Satellite Controllers on multi-controller sites
- Monitor dozens of Weather Sources including WSPRO2 Weather Stations, ET Managers, or rain counting sensors (Raingauge)
- Freedom Remote Control allows manual operation of system through a cellular phone or radio
- Multiple log and water usage reports are generated automatically to track system operation and water savings

Water Management Features

- Cross satellite schedule operation; 999 separate schedules per CCU provides precision watering of areas and microclimates
- ET Checkbook™ manages Evapotranspiration (ET) and automatically adjusts Satellite Controller station run-time or day cycle intervals to match the landscapes water requirements
- FloManager™ manages the total flow demand placed on the water source(s), optimizing both the available water and watering window
- FloWatch™ monitors flow sensors at each water source, records flow, and automatically reacts to problem flows by shutting down the effected portion of the system (individual valve or mainline)
- RainWatch™ monitors rain counting sensors, records rainfall, and automatically reacts to rainfall by interrupting irrigation, waiting to see how much rain has fallen, and determines if the irrigation should be resumed or cancelled

Operational Features

- Communication Control Engine automatically sends updated programming to sites before watering begins and retrieves logs after irrigation is completed; manual operation can be performed at any time
- Start day cycles: Custom (day of the week), Odd/Even, Odd31, or Cyclical and include Event Day Off Calendar scheduling
- Station run-times programmable from 1 minute to 16 hours
- Cycle + Soak™ optimizes water application to soil infiltration rate, reducing runoff and puddling
- Control non-irrigation functions such as lighting, fountains, door locks and gates

Maxicom² Communications Options

- Central Controller to CCU: Phone, direct connect, radio, cellular, network (Ethernet, Wi-Fi, fiber-optics)
- CCU to ESP-SAT2: Two-wire path
- CCU to ESP-SATL: Radio, MasterLink, network (Ethernet, Wi-Fi, fiber-optics)

Global Service Plan (GSP)

- Visit rainbird.com/gsp/index.htm for more information.

Models

- MC2GOLD1: New System - Desktop PC with Maxicom software, includes 1 year Global Support Plan (GSP)
- GSPMCPCL3: Current GSP Or Expired GSP Subscribers, Desktop PC with Maxicom software, includes 3 Years Platinum Plus Global Support Plan
- GSPMXPPCIA: Current GSP Subscribers, Desktop PC with Maxicom software, based on 3 Year Platinum Plus Global Support Plan, includes year 1 GSP, requires year 2 and 3 GSP to be purchased separately (M95543A2)
- GSPMXPPCIM: Current GSP Subscribers, Desktop PC with Maxicom software, based on 3 Years Platinum Plus Global Support Plan, includes month 1 GSP, requires month 2 - 36 GSP to be purchased separately (M95544M2)
- GSPMXPPNIA: New GSP or Expired GSP Subscribers, Desktop PC with Maxicom software, based on 3 Years Platinum Plus Global Support Plan, includes year 1 GSP, requires year 2 and 3 GSP to be purchased separately (M95541A2)
- GSPMXPPNIM: New GSP or Expired GSP Subscribers, Desktop PC with Maxicom software, based on 3 Years Platinum Plus Global Support Plan, includes month 1 GSP, requires month 2 - 36 GSP to be purchased separately (M95542M2)
- MC2UPG: Maxicom Upgrade Software - CD Only, upgrade existing Maxicom 1.X, 2.X and 3.X system to latest Maxicom Version



Maxicom

Maxicom²® Hardware

Cluster Control Unit CCU Interface

- Runs real-time operations of a site consisting of up to 28 satellites
- Adapts station sequence to changing conditions for maximum efficiency
- Instantly responds to unexpected conditions and sensor inputs

ESP-SAT Satellite Controller

- 40 Stations Satellite Controller
- Field Satellite Controller for Maxicom² or SiteControl Central Control systems
- The power of an advanced water-management tool, in an easy-to-use package
- All the features and stand-alone capabilities of the Rain Bird ESP-MC Controller line

ESP-SITE-SAT Satellite Controller

- 40 Stations Satellite Controller
- Combines power of a Cluster Control Unit (CCU) with capabilities of a single ESP-Satellite controller for small Maxicom² sites
- Advanced water-management tool, in an easy-to-use package
- All the features and stand-alone capabilities of the Rain Bird ESP-MC Controller line

Spread Spectrum Radio

- Frequency hopping to avoid interference
- Reduced cost of ownership, no FCC license required
- No FCC restrictions on antenna height (User should check local laws)
- Radios can be set up as repeater to achieve great distances and overcome obstacles

Ethernet Devices

- Use Ethernet networks to:
 - - Communicate from Central Control Computer to CCUs, SiteSats, TWIs and weather stations
 - - Communicate from CCU and TWIs to ESP-Sats

WS-PRO Weather Stations

- Scientific accuracy sensors located three meters above the ground for added vandal-resistance
- Powerful, internal micro-logger for climatic data collection, logging and analysis, constant communication with weather sensors, and storage of 30 days of data
- Rugged yet lightweight metal construction

Sensor-Pulse Decoders

- Complete feedback system
- Extends central control system versatility
- Color-coded wire leads for ease of installation
- Programmable address codes for individual operation

RAINGAUGE Rain Sensor

- Accurate rain counter switch counts rainfall in 1/100th inch increments
- Heavy-duty metal construction
- Mounting bracket
- Debris screen

ANEMOMETER Wind Sensor

- Accurate wind speed measurement for high-wind shutdown or interrupt of irrigation programs
- Heavy-duty metal mounting bracket
- Requires PT322 or PT5002 Pulse Transmitter/Monitor for use with Maxicom² System

Maxi Interface Boards

- Upgrades an ESP-MC Controller (wall mount or pedestal) to an ESP-SAT or ESP-SITE Satellite Controller
- No additional enclosures or external wiring required
- Installs on stand-offs on controller output board

MSP-1 Surge Protection

- Protects central control components from electrical surges on a two-wire communication path
- Can be installed in satellite or CCU pedestal or in valve box in conjunction with MGP-1 (Maxicom²® Grounding Plate)

MGP-1 Surge Grounding Plate

- Provides a mounting location for MSP-1 or other grounding wires directly to a grounding rod or pipe
- Installed on grounding rod or pipe



CCU-28-W



ESP-40SAT-2W Satellite



MSP-1



MGP-1



RAINGAUGE

WS-PRO Weather Stations

Maxicom²® (WS-PRO2 only), SiteControl, IQ™ v3.0 (WS-PRO2 and WSPROLT)

Features

- Scientific accuracy sensors located three meters above the ground for added vandal-resistance
- Powerful, internal micro-logger for climatic data collection, logging and analysis, constant communication with weather sensors, and storage of 30 days of data
- Rugged yet lightweight metal construction
- Self-diagnostic test mechanisms: internal moisture, battery voltage level, test port for local sensor check, and simple-to-service sensors and internal components
- State-of-the-art weather software calculates ET values, stores daily and historic ET values, monitors and displays current weather conditions, and graphically displays weather parameters

SiteControl Features

- WS-PRO2 and WS-PRO-LT Weather Station compatibility is standard for SiteControl v3.0 or later software
- SiteControl can interface with up to 6 weather stations
- Automatic communication between Central Controller and Weather Station requires SiteControl Automatic ET Software Module
- SiteControl Smart Weather Software Module enables automatic, user defined reactions to weather events (rain, freeze, high wind, etc.)

IQ™ Central Control Features

- WS-PRO2 or WS-PRO-LT Weather stations are compatible with IQ™
- IQ can interface with 100 weather stations

Maxicom²® Features (WS-PRO2 only)

- WS-PRO2 Weather Station compatibility is standard for Maxicom²® v3.6 or later software
- Each site can have its own Weather Station or can share between sites
- Automatic communication standard
- Up to 24 automatic weather data retrievals can be configured per day

Weather Station Sensors

- Air Temperature
- Solar Radiation
- Relative Humidity
- Wind Speed
- Wind Direction
- Rainfall

System Compatibility

- Maxicom² (WS-PRO2 only)
- SiteControl (requires Automatic ET Software Module)
- IQ™ Central Control

Models

- WS-PRO2-DC Direct Connect model – 2-pair wire connection with Central Controller via short-haul modem
- WS-PRO-LT-SH Short Haul model – 2-pair wire connection with Central Controller via short-haul modem



WS-PRO2
Weather Station

Spread Spectrum Radio

Maxicom², SiteControl or IQ[™]

Features

- Frequency hopping to avoid interference
- Reduced cost of ownership, no FCC license required
- No FCC restrictions on antenna height (User should check local laws)
- Radios can be set up as repeater to achieve great distances and overcome obstacles

Installation Requirements

- Site Survey required prior to ordering and must be submitted with order
- RADTN9MIB mounts directly onto ESP-SAT MIB; RADTN9TWI connects with ribbon cable
- Antenna and antenna cable required (sold separately by Rain Bird Production and Service Center)

Models

- **Radios – For IQ Primary & Secondary Communication and For Maxicom and Site Control Primary Communication**
 - IQSSRADIO: 900 MHz Spread Spectrum radio – Allows communication between Central Computer and IQ Direct or IQ Server Satellite, and between IQ Server Satellite and IQ Client Satellites. Also can be used for communication between Maxicom Central Computer and CCU or Site Satellite, between Site Control Central Computer and TWI / SDI or LDI, and between a Central Computer and weather station
- **Radios – For Maxicom and Site Control Secondary Communication**
 - RADTN9MIB: license free wireless radio (902-928 MHz) between CCU and satellites
 - RB-SS-TN9B: Plastic Case Radio – License free radio to communicate to IQ Satellites



Drip Irrigation

Major Products						
Primary Applications	Single outlet emitter	Multi-outlet emitter	Bubbler emitter	Spray	Inline emitter (Dripline)	RWS
Thick bushes		•	•	•	•	
Single bush	•					
Small trees	•	•			•	•
Large trees	•	•	•			•
Ground cover		•		•	•	
Annuals			•	•	•	
Mixed vegetation	•	•			•	
Potted plants	•		•	•	•	
Hedges	•				•	
Vegetation on slopes	•				•	

Water Saving
Water Saving Tips

- Drip products deliver water directly to the root zone. Use dripline for dense plantings where it's cost effective to distribute low-volume water evenly. Use a system of precise emitter devices for sparse plantings where it's cost effective to separately irrigate each plant.
- Use drip to eliminate overspray, and you'll eliminate waste. Eliminate unsightly spray stains on buildings and fences. Eliminate soil erosion, water runoff, and potential litigation. Walkways, roads, and vehicles stay dry.
- Ask your tax advisor about capital depreciation when calculating your return-on-investment for a drip retrofit. Save water, and save money at the same time.

- Introduction
- Spray Bodies
- Spray & Rotary Nozzles
- Rotors
- Valves
- Controllers
- Sensors & Meters
- Central Controls
- Drip Irrigation
- Pumps & Filtration
- Drainage Products
- Resources

Landscape Drip System Overview

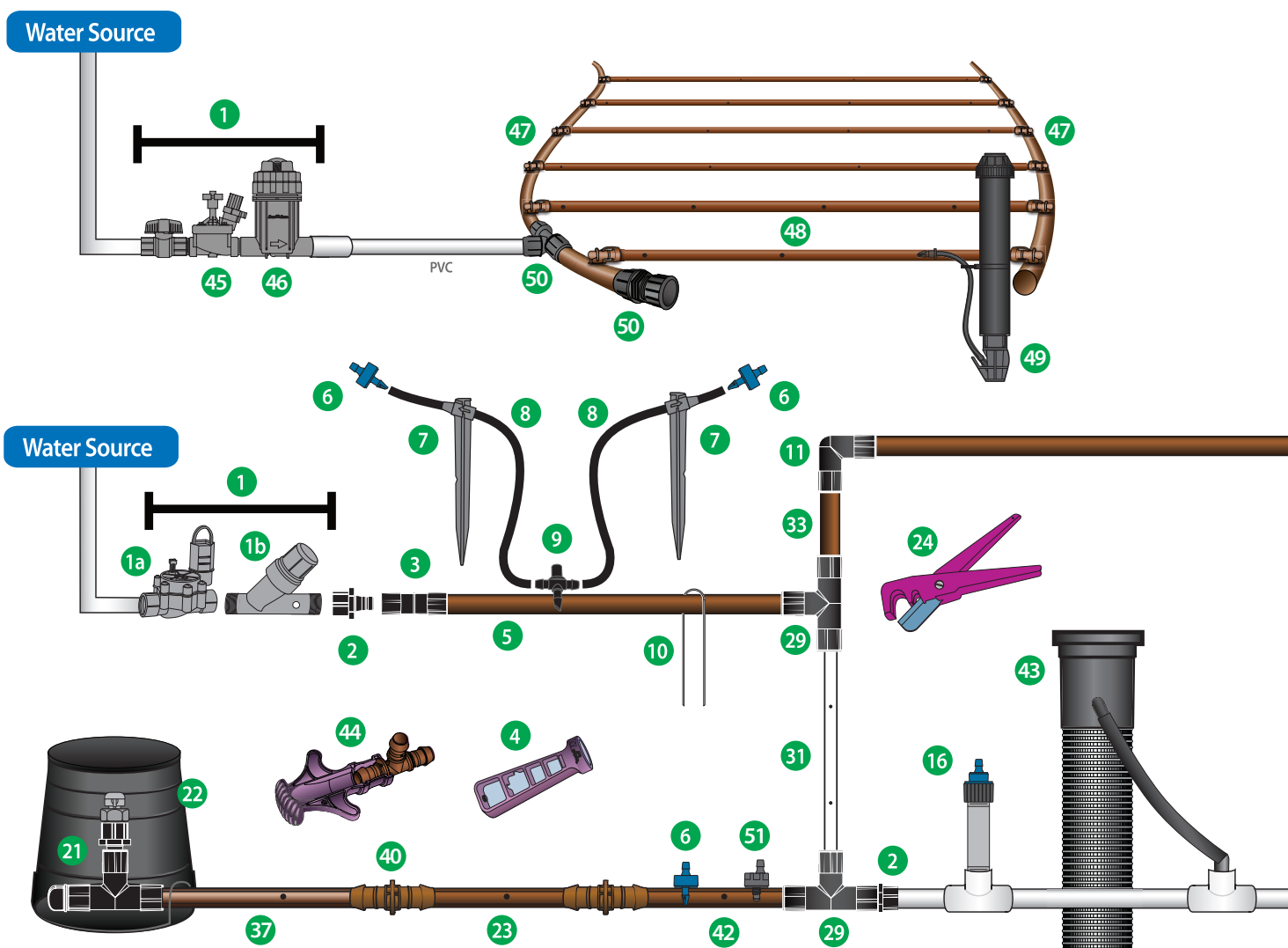
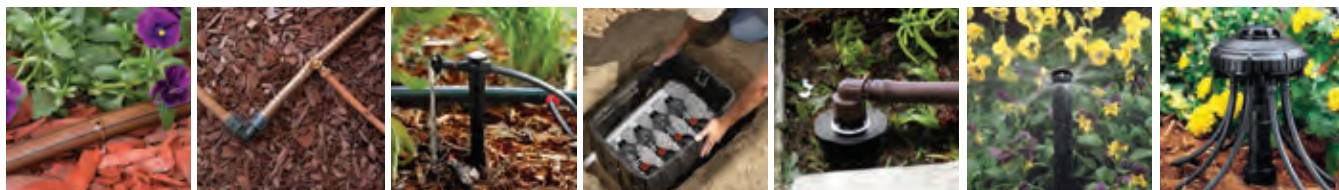

Drip Irrigation

- | | | |
|------------------------------------------|-----------------------------------------|-----------------------------------------------|
| 1. Control Zone Kit (pg. 152) | 8. XQ ¼" Distribution Tubing (pg. 150) | 17. ¼" Self-Piercing Barb Connector (pg. 120) |
| 1a. Low Flow Valve (pg. 160) | 9. ¼" Barb Tee (pg. 151) | 18. SQ Series Square Nozzle (pg. 124) |
| 1b. Pressure Regulating Filter (pg. 161) | 10. Tie-Down Stake (pg. 151) | 19. Xeri-Pop (pg. 126) |
| 2. Easy Fit Female Adapter (pg. 146) | 11. Easy Fit Elbow (pg. 146) | 20. Xeri-Bubbler SPYK (pg. 127) |
| 3. Easy Fit Coupling (pg. 146) | 12. Diffuser Bug Cap (pg. 129) | 21. ARV050 Air Relief Valve Kit (pg. 147) |
| 4. Xeriman Tool (pg. 118) | 13. PC Emitter Diffuser Cap (pg. 129) | 22. SEB-7X Emitter Valve Box (pg. 151) |
| 5. XF Series Blank Tubing (pg. 148) | 14. PC Module-1032 (pg. 122) | 23. XFD Dripline (pg. 135) |
| 6. Xeri-Bug Emitter (pg. 118) | 15. PolyFlex Riser Assembly (pg. 130) | 24. Tubing Cutter (pg. 151) |
| 7. ¼" Tubing Stake (pg. 129) | 16. Xeri-Bug Emitter - ½" FPT (pg. 118) | 25. Xeri-Bird 8 (pg. 121) |

Targeted Watering with Landscape Drip

Rain Bird Xerigation®/Landscape Drip products are made especially for low-volume irrigation systems. By delivering water at or near the plants' root zones, Rain Bird Xerigation® products offer targeted watering with the following advantages:

- Water conservation
- Greater efficiency (target each plant)
- Design flexibility; simple construction and easily expandable
- Healthier plants
- Reduced liability (e.g. no overspray, no runoff)
- Minimization of weed growth
- Cost savings

Broadest Product Line in the Industry

With over 150 products, Rain Bird has the products needed for your application. Systems can be designed to meet any site requirements and offer many exclusive Rain Bird advances including:

- Flexible XF Series dripline with advanced polymers that provide kink-resistance and reduced coil memory for easier installation
- Compact Control Zones with combined pressure regulator and filter to reduce parts, potential leak problems, and allow for fitting more Control Zones in a valve box
- Precision low volume SQ spray nozzles that offer a square wetting pattern and adjust to either 2.5' or 4' throw distances
- Point-source emitters that provide pressure compensation with a wide selection of flow rates and three inlet options (Barb, 1032 threaded, and ½" FPT)
- XFS and XFS-CV dripline with Copper Shield Technology™ for use in sub-surface applications under turf or shrub and groundcover areas. The copper chip effectively protects the emitter from root intrusion

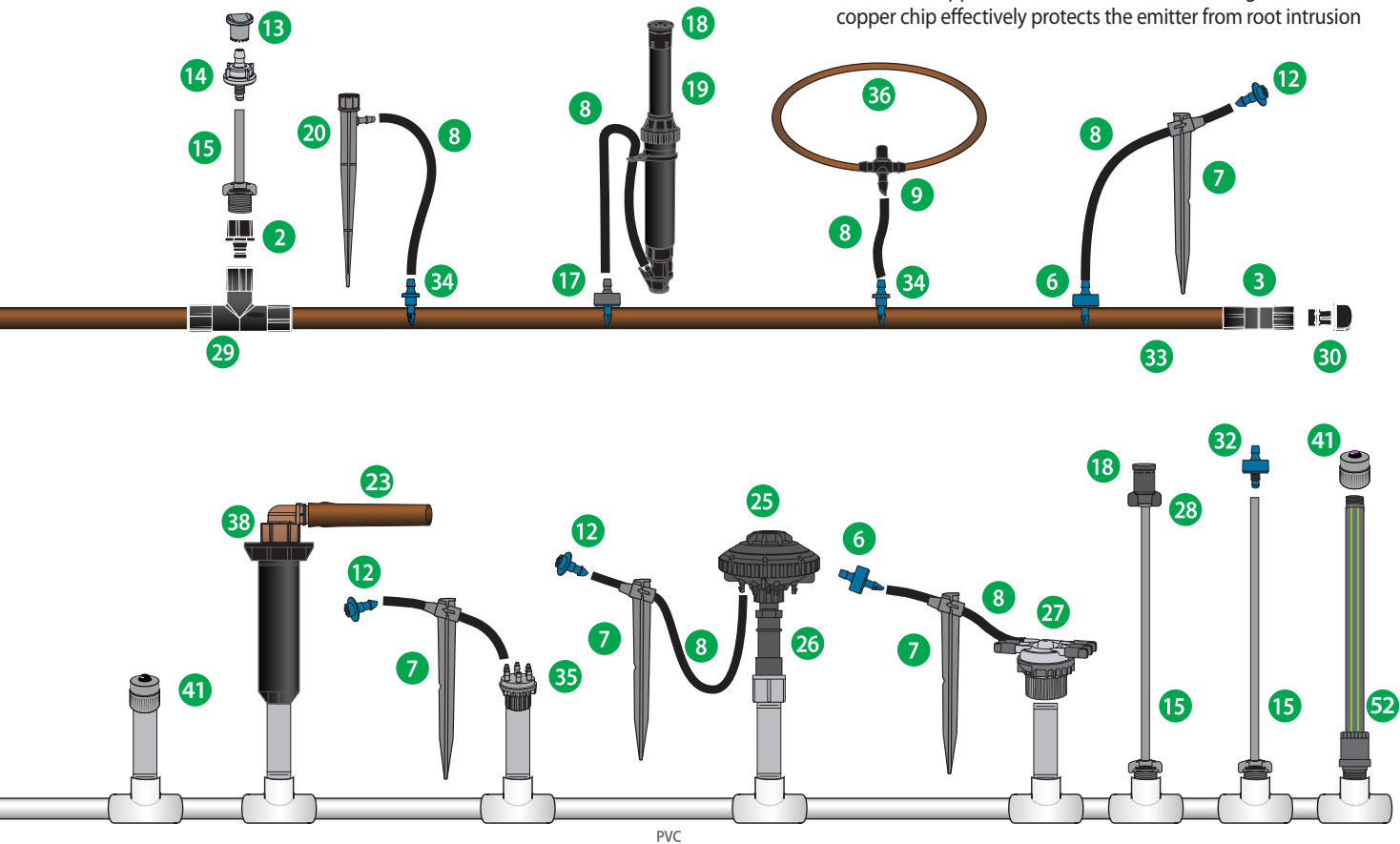

- 26. Retrofit Pressure Regulator (pg. 163)
- 27. 6 Outlet Manifold (pg. 120)
- 28. SQ Series Nozzle Adapter (pg. 124)
- 29. Easy Fit Tee (pg. 146)
- 30. Easy Fit Flush Cap (pg. 146)
- 31. Purple XF Dripline (pg. 135)
- 32. Xeri-Bug Emitter - 1032 (pg. 118)
- 33. XF Series Blank Tubing (pg. 148)
- 34. ¼" Barb Connector (pg. 151)
- 35. Multi-Outlet Xeri-Bug (pg. 120)

- 36. ¼" Landscape Dripline (pg. 151)
- 37. XFS-CV Sub-Surface Dripline with Copper Shield Technology (pg. 141)
- 38. RETRO-1800 Spray-to-Drip Retrofit Kit (pg. 167)
- 39. XT-025 ½" FPT x Barb Grey Transfer Fitting (pg. 120)
- 40. XFF Coupling (pg. 145)
- 41. PCT Bubbler (pg. 122)
- 42. XFCV Dripline with Heavy-Duty check valve (pg. 137)
- 43. RWS (Root Watering System) (pg. 132)
- 44. XF Insertion Tool (pg. 147)

- 45. PEB Valve (pg. 67)
- 46. Quick-Check Pressure Regulating Filter (pg. 164)
- 47. QF Dripline Header (pg. 143)
- 48. XF Series Dripline (XFD/XFS/XFCV/XFS-CV) (pg. 135-141)
- 49. Operation Indicator (pg. 147)
- 50. Twist Lock Fittings (pg. 144)
- 51. Xeri-Bug™ with Check Valve (pg. 115)
- 52. XDD12-CV Riser (pg. 131)

Xeri-Bug™ with Check Valve

Point-Source Low-Flow Emitters for Watering the Root Zones of Plants, Trees, and Container Plants

NEW

Features

Efficient Water Usage

- With 10 feet (3 m) of hold-back power, XBCV eliminates low-point drainage and provides uniform irrigation throughout the zone
- Strong check-valve protection helps conserve water by eliminating low-point drainage and flooding. In a standard 500-foot (152 m) line with 1/2" (13 mm) internal diameter, 20 gallons (76 L) of water is held in the line instead of draining out
- In a zone that has a 10-foot (3 m) elevation change, only one zone is needed for the XBCV. Fewer zones allow you to save money on valves and time on installation

Holds Water in the Line

- Designed to hold water in the line, these emitters immediately begin irrigation and reduce zone run times
- By holding water in the line when the system is turned off, XBCV prevents particles from clogging the emitter — a problem when a system drains and siphons dirty water
- Holding water in the line reduces calcium build-up and extends the life of the emitter

All-in-One Design

- With its comprehensive capabilities, the XBCV can be taken to any jobsite. It's the only emitter you need to stock, carry and install, simplifying point-source drip jobs

Pressure Compensating

- A pressure-compensating design offers a consistent flow from 15 to 50 psi (1.0 to 3.5 bar)
- XBCV delivers the same amount of water from the first emitter in the line to the last

Self Cleaning

- A self-flushing action cleans the emitters every time the system turns on and off, reducing maintenance and extending the life of the emitter.

Self-Piercing Barb

- Self-piercing models feature barbs that eliminate the need for a hole-punching tool, making installation easier

Risers and Adapters

- Models with 10-32 threaded ends can quickly connect to risers or adapters.

Compact Design

- With a diameter less than a dime, the emitter is unobtrusive and easily hidden

Operating Range

- Opening Pressure: 15 psi (1.0 bar)
- Pressure: 15 to 50 psi (1.0 to 3.5 bar)
- Flow Rates: 0.5, 1.0 or 2.0 gph (1.9, 3.79 or 7.57 l/h)
- Filtration Requirement: 200 mesh (75 micron) for 0.5 gph, 150 mesh (100 micron) for all others

Models

Self-Piercing Barb Inlet x Barb Outlet

- XBCV-05PC: Blue, 0.5 gph (1.9 lph)
- XBCV-10PC: Black, 1.0 gph (3.8 lph)
- XBCV-20PC: Red, 2.0 gph (7.6 lph)

10-32 Threaded Inlet x Barb Outlet

- XBCV-05PC-1032: Blue, 0.5 gph (1.9 lph)
- XBCV-10PC-1032: Black, 1.0 gph (3.8 lph)
- XBCV-20PC-1032: Red, 2.0 gph (7.6 lph)

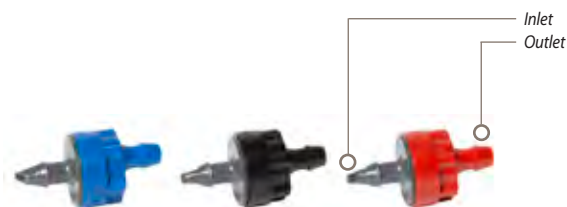

XBCV-05PC, XBCV-10PC, XBCV-20PC



XBCV-05PC-1032, XBCV-10PC-1032, XBCV-20PC-1032

1032-threaded models are specifically designed to be used with PolyFlex Risers, 1032 thread adapters (1032-A), or 1800 Xeri-Bubbler Adapter (XBA-1800)

Xeri-Bug Check Valve Bag Quantities and Models

Flow Rate	Color	Bag Qty.	Model Number
0.5 GPH (1.89 l/h)	Blue	25	XBCV05PC
		100	XBCV05PCBULK
1.0 GPH (3.79 l/h)	Black	25	XBCV10PC
		100	XBCV10PCBULK
2.0 GPH (7.57 l/h)	Red	25	XBCV20PC
		100	XBCV20PCBULK

How to Specify

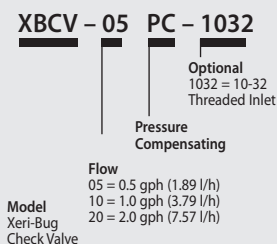

Xeri-Bug Check Valve Specifications and Models

Model	Inlet Type/Color	Nominal Flow gph	Filtration Required mesh
XBCV-05PC	Barb/Blue	0.5	200
XBCV-10PC	Barb/Black	1.0	150
XBCV-20PC	Barb/Red	2.0	150
XBCV-05PC1032	10-32T/Blue	0.5	200
XBCV-10PC1032	10-32T/Black	1.0	150
XBCV-20PC1032	10-32T/Red	2.0	150

Xeri-Bug Check Valve Performance

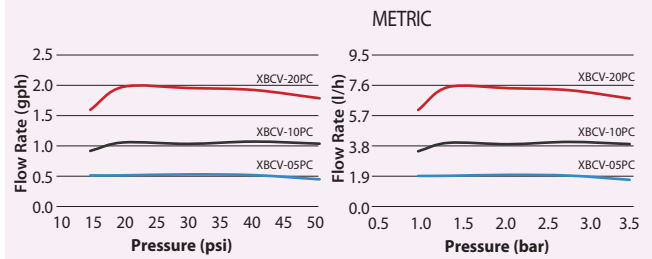

Xeri-Bug Check Valve Specifications and Models METRIC

Model	Inlet Type/Color	Nominal Flow l/h	Filtration Required micron
XBCV-05PC	Barb/Blue	1.89	75
XBCV-10PC	Barb/Black	3.79	100
XBCV-20PC	Barb/Red	7.57	100
XBCV-05PC1032	10-32T/Blue	1.89	75
XBCV-10PC1032	10-32T/Black	3.79	100
XBCV-20PC1032	10-32T/Red	7.57	100

(For reference numbers below, please see the System Overview page 114)

Installation Option 1*

Using a Xeriman Tool, insert an emitter directly into 1/2" or 3/4" drip tubing or between dripline emitters as needed.



Installation Option 2*

For more precise water placement, use 1/4" distribution tubing, a 1/4" tubing stake, and a bug cap.

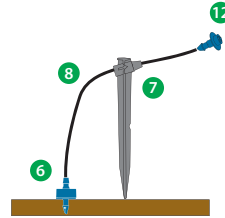

Installation Option 3

For precise water placement, a barbed connector can be punched into distribution tubing. The emitter is then placed at the end of the 1/4" distribution tubing. NOTE: should the emitter become dislodged, unregulated flow will occur.

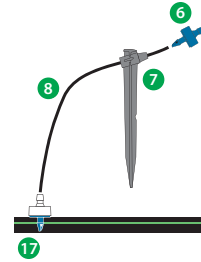

Installation Option 4*

The Xeri-Bird 8 provides a centralized location for up to eight emitters. A mix of Xeri-Bug and/or PC emitters can be used to provide the flow rates needed for different plant materials. Tentacles of 1/4" distribution tubing, 1/4" tubing stakes, and bug caps allow for precise water placement.

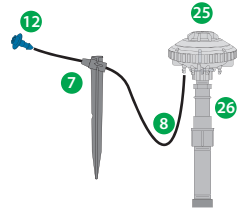

Installation Option 5

The 6 Outlet Manifold provides a centralized water distribution connection for up to six emission devices. Connect the 1/4" distribution tubing to one of the outlets. Use a 1/4" tubing stake to ensure precise water placement. The emitter is placed on the end of the 1/4" distribution tubing to regulate the water flow. NOTE: should the emitter become dislodged, unregulated flow will occur.

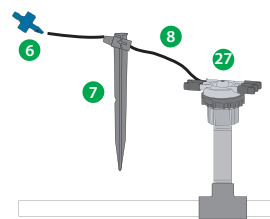

Xeri-Bug™ Emitter with Check Valve

* Preferred installation options, which provide flow regulation at the source.

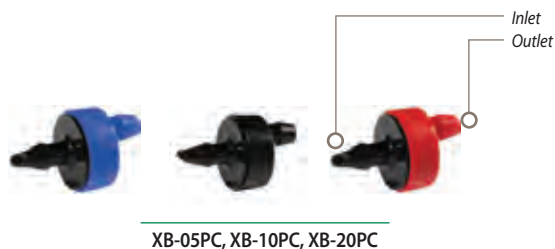

XB-05PC, XB-10PC, XB-20PC



XB-05PC-1032, XB-10PC-1032, XB-20PC-1032

1032-threaded models are specifically designed to be used with PolyFlex Risers, 1032 thread adapters (1032-A), or 1800 Xeri-Bubbler Adapter (XBA-1800)

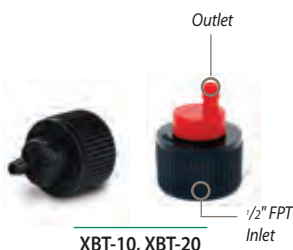

XBT-10, XBT-20

Xeriman™ Tool

Features

- Provides fast, easy, one-step installation of Xeri-Bug™ emitters and PC Modules directly into 1/2" or 3/4" drip tubing, XF Dripline or Landscape Dripline
- Cuts emitter installation time
- All-in-one tool inserts emitters, removes emitters, inserts 1/4" barbed fittings and installs goof plugs

Model

- XM-TOOL



XM-TOOL



One Step Xeri-Bug™ Insertion

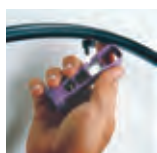

Xeri-Bug™ Removal



Goof Plug Insertion

Xeri-Bug™ Emitters

Point-Source Low-Flow Emitters for Watering the Root Zones of Plants, Trees, and Container Plants

Features

- The only emitters with self-piercing barbs, making them the easiest to install using the Xeriman™ tool
- Widest selection of pressure-compensating emitters, with 3 flow rates and 3 inlet options
- Most compact and unobtrusive emitters
- Flow-rates of 0.5, 1.0 and 2.0 gph (1.89, 3.79 and 7.57 l/h)
- Pressure-compensating design delivers uniform flow throughout a wide pressure range (15 to 50 psi; 1.0 to 3.5 bar)
- Available with 3 different inlets (1.0 and 2.0 models):
 - Self-piercing barb for quick, one-step insertion into 1/2" or 3/4" drip tubing
 - 10-32 threaded inlet that easily threads into a PolyFlex Riser (see page 130), 1032 Thread adapter (page 130) or 1800 Xeri-Bubbler Adapter (page 130)
 - 1/2" FPT inlet that easily threads onto a 1/2" PVC riser (1.0 and 2.0 gph models)
- Outlet barb securely retains 1/4" Distribution Tubing (XQ)
- Design makes installation and maintenance easy
 - Self-flushing action minimizes clogging
 - Robust design made from highly inert materials that are resistant to chemicals
 - Durable plastic construction is UV-resistant
- Color-coded to identify flow rate

Operating Range

- Flow: 0.5 to 2.0 gph (1.89 to 7.57 l/h)
- Pressure: 15 to 50 psi (1.0 to 3.5 bar)
- Required filtration: 150 to 200 mesh (100 to 75 micron - see chart pg. 119)

Models: 10-32 thread inlet x barb outlet

- XB-05PC-1032: Blue, 0.5 gph (1.89 l/h)
- XB-10PC-1032: Black, 1.0 gph (3.79 l/h)
- XB-20PC-1032: Red, 2.0 gph (7.57 l/h)

Models: 1/2" FPT inlet x barb outlet

- XBT-10: Black, 1.0 gph (3.79 l/h)
- XBT-20: Red, 2.0 gph (7.57 l/h)

Models: barb inlet x barb outlet

- XB-05PC: Blue, 0.5 gph (1.89 l/h)
- XB-10PC: Black, 1.0 gph (3.79 l/h)
- XB-20PC: Red, 2.0 gph (7.57 l/h)

Xeri-Bug Emitter Bag Quantities and Models

Flow Rate	Color	Bag Qty.	Model Number
0.5 GPH (1.89 l/h)	Blue	25	XB05PC
		100	XB05PCBULK
		8000	XB05MAXPAK
1.0 GPH (3.79 l/h)	Black	25	XB10PC
		100	XB10PCBULK
		8000	XB10MAXPAK
2.0 GPH (7.57 l/h)	Red	25	XB20PC
		100	XB20PCBULK
		8000	XB20MAXPAK

How to Specify

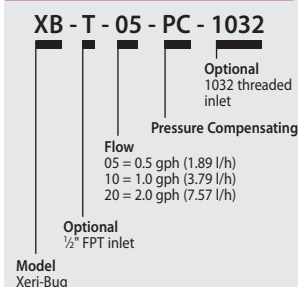

Xeri-Bug Emitter Specifications and Models

Model	Inlet Type/Color	Nominal Flow gph	Filtration Required mesh
XB-05PC	Barb/Blue	0.5	200
XB-10PC	Barb/Black	1.0	150
XB-20PC	Barb/Red	2.0	150
XB-05PC1032	10-32T/Blue	0.5	200
XB-10PC1032	10-32T/Black	1.0	150
XB-20PC1032	10-32T/Red	2.0	150
XBT-10PC	1/2" FPT/Black	1.0	150
XBT-20PC	1/2" FPT/Black	2.0	150

Xeri-Bug Emitter Specifications and Models

METRIC

Model	Inlet Type/Color	Nominal Flow l/h	Filtration Required micron
XB-05PC	Barb/Blue	1.89	75
XB-10PC	Barb/Black	3.79	100
XB-20PC	Barb/Red	7.57	100
XB-05PC1032	10-32T/Blue	1.89	75
XB-10PC1032	10-32T/Black	3.79	100
XB-20PC1032	10-32T/Red	7.57	100
XBT-10PC	1/2" FPT/Black	3.79	100
XBT-20PC	1/2" FPT/Black	7.57	100



Xeri-Bug™ Emitter, TS025-1/4" stake, and DBC025 Diffuser Bug Cap

Xeri-Bug Emitter Performance

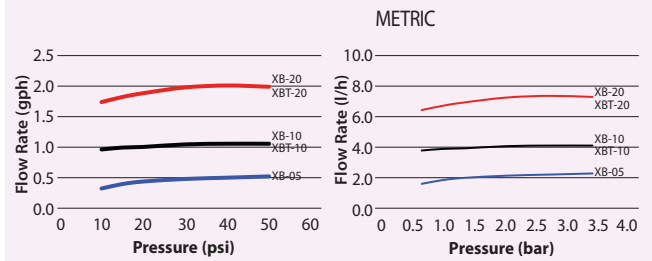

(For reference numbers below, please see the System Overview page 114)

Installation Option 1*

Using a Xeriman Tool, insert an emitter directly into 1/2" or 3/4" drip tubing or between dripline emitters as needed.



Installation Option 2*

For more precise water placement, use 1/4" distribution tubing, a 1/4" tubing stake, and a bug cap.

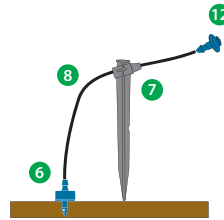

Installation Option 3

For precise water placement, a barbed connector can be punched into distribution tubing. The emitter is then placed at the end of the 1/4" distribution tubing. NOTE: should the emitter become dislodged, unregulated flow will occur.

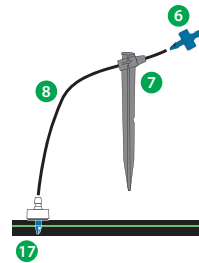

Installation Option 4*

The Xeri-Bird 8 provides a centralized location for up to eight emitters. A mix of Xeri-Bug and/or PC emitters can be used to provide the flow rates needed for different plant materials. Tentacles of 1/4" distribution tubing, 1/4" tubing stakes, and bug caps allow for precise water placement.

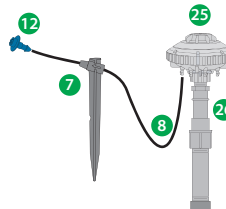

Installation Option 5

The 6 Outlet Manifold provides a centralized water distribution connection for up to six emission devices. Connect the 1/4" distribution tubing to one of the outlets. Use a 1/4" tubing stake to ensure precise water placement. The emitter is placed on the end of the 1/4" distribution tubing to regulate the water flow. NOTE: should the emitter become dislodged, unregulated flow will occur.

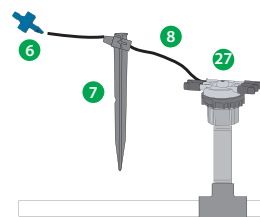

* Preferred installation options, which provide flow regulation at the source.

Multi-Outlet Xeri-Bug™

Features

- Pressure compensating design delivers uniform flow throughout a wide pressure range (15 to 50 psi; 1.0 to 3.5 bar)
- Six-outlet emitter supplied with one outlet opened. Simply clip the outlet tips open with snips or clippers for additional operational ports
- Barbed outlets retain ¼" Distribution Tubing (XQ)
- Self-flushing action minimizes clogging
- Durable, UV-resistant color-coded plastic housing

Operating Range

- Flow: 0.5, 1.0 or 2.0 gph (1.89, 3.79 or 7.57 l/h)
- Pressure: 15 to 50 psi (1.0 to 3.5 bar)
- Filtration: 150-mesh (100-microns)

Models: barb inlet x barb outlet

- XB-05-6: Blue, 0.5 gph (1.89 l/h)
- XB-10-6: Black, 1.0 gph (3.79 l/h)
- XB-20-6: Red, 2.0 gph (7.57 l/h)

Models: ½" FPT inlet x barb outlet

- XBT-05-6: Blue, 0.5 gph (1.89 l/h)
- XBT-10-6: Black, 1.0 gph (3.79 l/h)
- XBT-20-6: Red, 2.0 gph (7.57 l/h)



XB-05-6, XB-10-6, XB-20-6



XBT-05-6, XBT-10-6, XBT-20-6

Multi-Outlet Xeri-Bug Emitter Performance

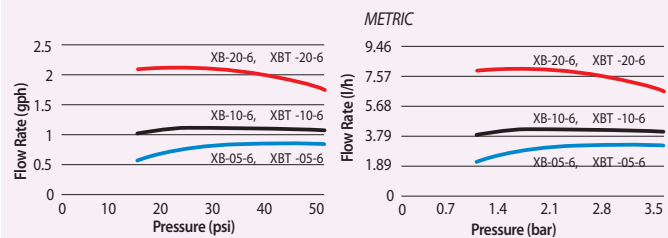

6 Outlet Manifold - EMT-6XERI

Features

- ½" FPT inlet threads onto ½" riser and provides a manifold with six free-flowing ¼" barb outlets
- Each barb outlet is sealed with a durable plastic cap
- Plastic caps remove easily, allowing for a drip area that can be customized with up to six different emission devices
- Attach ¼" Distribution Tubing (XQ) onto each outlet for use with: Xeri-Bugs, PC Modules, Xeri-Pops, Xeri-Sprays, and Xeri-Bubblers

Operating Range

- Pressure: 15 to 50 psi (1.0 to 3.5 bar)
- Required filtration: 150 mesh (100 microns)

Model

- EMT-6XERI



EMT-6XERI

¼" Self-Piercing Barb Connector

Features

- Used to connect ¼" Distribution Tubing into ½" or ¾" distribution tubing
- Self-piercing barb inlet is easily inserted into ½" or ¾" distribution tubing using a Xeriman™ Tool (XM-Tool)
- Outlet barb accepts ¼" Distribution Tubing (XQ). Gray outlet barb indicates unit has unrestricted flow

Operating Range

- Pressure: 0 to 50 psi (0 to 3.5 bar)

Model

- SPB-025

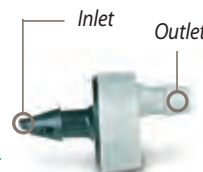

SPB-025

½" FPT x Barb Grey Transfer Fitting

Features

- Grey outlet to designate open flow
- ½" FPT inlet can be easily attached to a schedule 80 riser or the top of an 1800 Retro
- Barbed outlet so ¼" distribution tubing or ¼" drip tubing can be easily and securely attached

Operating Range

- Pressure: 0 to 50 psi (0 to 3.5 bar)

Model

- XT025



XT025

Xeri-Bird™ 8-Outlet Emission Device

The Most Flexible and Feature-Rich Multi-Outlet Device on the Market, Ideal for New Projects and Retrofit Applications

Features

- The only multi-outlet device on the market with 8 configurable ports and 10 flow options for each port for maximum flexibility
- XBD-80 and XBD-81 models each contain a built-in filter. Makes retrofitting easy when installed with the optional in-stem pressure regulator (PRS-050 page 163)
- Easy to maintain, because body can be easily removed from riser
- Threads onto any 1/2" riser and delivers water to multiple locations for increased system flexibility
- Each port accepts a Xeri-Bug™ Emitter or PC Module for independent flows from 0.5 to 24 gph (1.89 to 90.84 l/h) or use a self-piercing barb connector (SPB-025) for unrestricted flow
- XBD-80 and XBD-81 models each feature an integral 200 mesh (75 micron) filter which is easily serviceable from the top of the unit
- Eight bottom-mounted, sure-grip barbed outlets securely retain 1/4" Distribution Tubing (XQ)
- Unique union base nut allows removal of Xeri-Bird 8 body from riser for easy installation and maintenance
- Emitters must be installed inside the Xeri-Bird to prevent excess back pressure

Operating Range

- Flow: 0.5 to 24 gph (1.89 to 90.84 l/h) per outlet
- Pressure: 15 to 50 psi (1.0 to 3.5 bar)

Models

- XBD-80: Xeri-Bird 8 unit (includes 7 removable port plugs and filter)
- XBD-81: Xeri-Bird 8 unit (includes eight 1 gph (3.79 l/h) Xeri-Bug emitters factory installed, and filter)

Replacement Parts:

- XBD8SCRN: replacement screen and two o-rings



Each port can be configured on the Xeri-Bird™ by installing flow controlled emitters. Above shows a combination of 0.5, 1.0, and 2.0 gph Xeri-Bug emitters.



Helpful Hint: Always install emitters with the pointed end (inlet barb) or threaded end up, as shown

* Must be installed second
** Must be installed first



PC-05, PC-07, PC-10



PC-12, PC-18, PC-24



PC-05-1032, PC-07-1032, PC-10-1032

10-32-threaded models are specifically designed to be used with PolyFlex Risers, 10-32 thread adapters (1032-A), or 1800 Xeri-Bubbler Adapter (XBA-1800)



PCT-05, PCT-07, PCT-10

• 1/2" FPT inlet that easily threads onto a 1/2" PVC riser

Pressure-Compensating Modules

Point-Source Medium-Flow Emitters for Watering Larger Shrubs and Trees

Features

- The only emitters with self-piercing barbs, making them the easiest to install using the Xeriman™ tool
- Widest selection of pressure-compensating emitters, with 6 flow rates and 3 inlet options
- Most compact and unobtrusive emitters
- Flow rates from 5 to 24 gph (18.93 to 90.84 l/h)
- Pressure-compensating design delivers uniform flow throughout a wide pressure range (10 to 50 psi; 0.7 to 3.5 bar)
- Available with 3 different inlets:
 - Self-piercing barbs for quick one-step emitter insertion into 1/2" or 3/4" drip tubing
 - 10-32 threaded inlet that easily threads into a PolyFlex Riser (see page 130), 1032 Thread adapter (page 130) or 1800 Xeri-Bubbler Adapter (page 130)
 - 1/2" FPT inlet that easily threads onto a 1/2" PVC riser
- Robust design - durable plastic construction is UV-resistant and color-coded to identify flow rate

Operating Range*

- Flow: 5 to 24 gph (18.93 to 90.84 l/h)
- Pressure: 10 to 50 psi (0.7 to 3.5 bar)
- Required filtration: 100 mesh (150 micron)

* **IMPORTANT NOTE:** Use a PC Diffuser Cap to eliminate squirting water when using a PC Module staked at the end of 1/4" Distribution Tubing (XQ) or on a PolyFlex Riser (PFR/FRA)

Models: barb inlet x barb outlet

- PC-05: Light brown, 5 gph (18.93 l/h)
- PC-07: Violet, 7 gph (26.50 l/h)
- PC-10: Green, 10 gph (37.85 l/h)
- PC-12: Dark brown, 12 gph (45.42 l/h)
- PC-18: White, 18 gph (68.13 l/h)
- PC-24: Orange, 24 gph (90.84 l/h)

Models: 10-32 thread inlet x barb outlet

- PC-05-1032: Light brown, 5 gph (18.93 l/h)
- PC-07-1032: Violet, 7 gph (26.50 l/h)
- PC-10-1032: Green, 10 gph (37.85 l/h)

Models: 1/2" FPT thread Inlet

- PCT-05: Light Brown, 5 gph (18.93 l/h)
- PCT-07: Violet, 7 gph (26.50 l/h)
- PCT-10: Green, 10 gph (37.85 l/h)

How to Specify

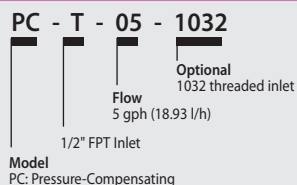

Pressure-Compensating Modules

Pressure-Compensating Module Models			
Model	Inlet Type/ Outlet/Color	Nominal Flow gph	Filtration Required mesh
PC-05	Barb / light brown	5	100
PC-07	Barb / violet	7	100
PC-10	Barb / green	10	100
PC-12	Barb / dark brown	12	100
PC-18	Barb / white	18	100
PC-24	Barb / orange	24	100
PC-05-1032	10-32T / light brown	5	100
PC-07-1032	10-32T / violet	7	100
PC-10-1032	10-32T / green	10	100
PCT-05	NPT / light brown	5	100
PCT-07	NPT / violet	7	100
PCT-10	NPT / green	10	100

Pressure-Compensating Module Models			METRIC
Model	Inlet Type/ Outlet/Color	Nominal Flow l/h	Filtration Required micron
PC-05	Barb / light brown	18.93	150
PC-07	Barb / violet	26.50	150
PC-10	Barb / green	37.85	150
PC-12	Barb / dark brown	45.42	150
PC-18	Barb / white	68.13	150
PC-24	Barb / orange	90.84	150
PC-05-1032	10-32T / light brown	18.93	150
PC-07-1032	10-32T / violet	26.50	150
PC-10-1032	10-32T / green	37.85	150
PCT-05	NPT / light brown	18.93	150
PCT-07	NPT / violet	26.50	150
PCT-10	NPT / green	37.85	150

Pressure-Compensating Modules & Bubblers Performance

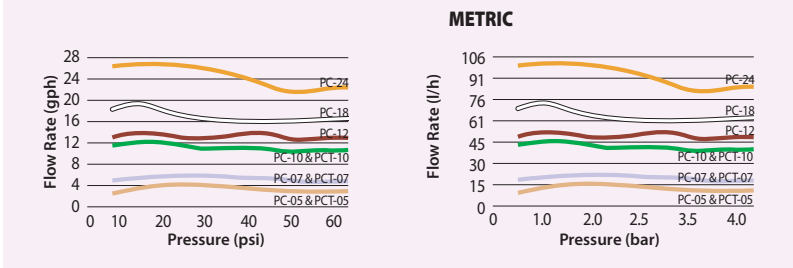

PC Diffuser Caps



PC Diffuser Caps are designed to fit onto outlet of pressure-compensating drip modules

Models: (see page 129 for complete information)

- PC-DIFFUSER: Black
- PC-DIFF-PPL: Purple, to designate non-potable water



PC Module (PC-10-1032) with PC Diffuser Cap (PC-DIFFUSER) on PolyFlex Riser (PFR-PFA) (PolyFlex Risers available in 12" and 24" models - p. 130)



SQ Nozzle Installed on PolyFlex Riser with Nozzle Adapter



SQ Nozzles with Screens

One Nozzle...Two Throws

With a simple turn of the nozzle to the next preset stop, the Rain Bird SQ Nozzle adjusts from a 2.5' (0.8 m) throw to a 4' (1.2 m) throw. It's like having two nozzles in one.



Can be used on...

The SQ Nozzle is an ideal solution for a wide range of difficult-to-design areas, thanks to its compatibility with popular irrigation products.



1800° Series Spray Heads

Xeri-Pop Spray Heads

Polyflex Risers

Schedule 80 Risers

SQ Series, Square Pattern Nozzles

The Most Precise and Efficient, Low-Volume Spray Solution for Irrigation of Small Areas with Dense Plantings

Features

- Square spray pattern and pressure compensation offer increased efficiency and control, reducing overspray, property damage and liability
- Simplify design and installation with the flexibility of applications: one nozzle throws 2.5' or 4' (0.8 m or 1.2 m) and can be used on a variety of spray heads and risers
- Meets micro irrigation system requirement for less than 26 gph flow rate at 30 psi
- Square spray pattern with edge-to-edge coverage allows you to easily design and install in small spaces
- Pressure compensation design delivers uniform flow over the pressure range
- Available in 3 models—quarter, half and full patterns with matched precipitation rate
 - Virtually no-mist performance from 20 psi to 50 psi
 - Two throw distances in each nozzle. One simple click adjusts to 2.5' or 4' (0.8 m or 1.2 m)
 - Shipped with blue filter screen (0.02" x 0.02") to maintain precise distance of flow, and to prevent clogging
- Compatible with all 1800 Sprays, Xeri-Pops, New PolyFlex Riser Adapter, UNI-Spray and SCH 80 risers

Operating Range

- Pressure: 20 to 50 psi (1.4 to 3.5 bar)
- Flow rates: 6, 12 and 24 gph (22.7, 45.4 and 90.8 l/h)
- Required filtration: 40 mesh

Models

- SQ-QTR: SQ Nozzle, quarter pattern (Purple)
- SQ-HLF: SQ Nozzle, half pattern (Brown)
- SQ-FUL: SQ Nozzle, full pattern (Red)
- SQ-ADP: SQ PolyFlex Riser Adapter only
- SQ-ADP12: SQ Nozzle Adapter with 12" PolyFlex Riser

* **Note:** A PA-8S Plastic Shrub Adapter (see page 10) is needed when using an SQ Series Nozzle mounted on a SCH 80 riser.









SQ-QTR



SQ-HLF



SQ-FUL

SQ-ADP

SQ Nozzle Performance					
2.5 feet throw @ 6" height above grade					
Nozzle	Pressure psi	Throw Radius ft.	Flow gph	Flow gpm	Precip.Rate w/no overlap in/h
Q 	20	2.5	6.0	0.10	1.64
	30	2.5	7.0	0.12	1.90
	40	3.0	7.2	0.12	1.32
	50	3.0	7.2	0.12	1.32
H 	20	2.5	10.2	0.17	1.31
	30	2.5	10.7	0.18	1.57
	40	3.0	10.7	0.18	1.22
	50	3.0	10.7	0.18	1.22
F 	20	2.5	20.0	0.33	1.28
	30	2.5	24.2	0.40	1.55
	40	3.0	27.3	0.46	1.22
	50	3.0	27.3	0.46	1.22

SQ Nozzle Performance					METRIC
0.8 m throw @ 0.15 m height above grade					
Nozzle	Pressure bar	Throw Radius m	Flow lph	Flow lpm	Precip.Rate w/no overlap mm/h
Q 	1.4	0.8	23	0.38	42
	2.1	0.8	27	0.44	48
	2.8	0.9	27	0.45	34
	3.4	0.9	27	0.45	34
H 	1.4	0.8	39	0.65	33
	2.1	0.8	41	0.68	40
	2.8	0.9	41	0.68	31
	3.4	0.9	41	0.68	31
F 	1.4	0.8	76	1.27	33
	2.1	0.8	92	1.53	39
	2.8	0.9	103	1.72	31
	3.4	0.9	103	1.72	31

SQ Nozzle Performance					
4 feet throw @ 6" height above grade					
Nozzle	Pressure psi	Throw Radius ft.	Flow gph	Flow gpm	Precip.Rate w/no overlap in/h
Q 	20	4.0	6.0	0.10	0.64
	30	4.0	7.2	0.12	0.74
	40	4.5	7.2	0.12	0.59
	50	4.5	7.2	0.12	0.59
H 	20	4.0	10.2	0.17	0.51
	30	4.0	10.7	0.18	0.61
	40	4.5	10.7	0.18	0.54
	50	4.5	10.7	0.18	0.54
F 	20	4.0	20.0	0.33	0.50
	30	4.0	24.2	0.40	0.61
	40	4.5	27.3	0.46	0.54
	50	4.5	27.3	0.46	0.54

SQ Nozzle Performance					METRIC
1.2 m throw @ 0.15 m height above grade					
Nozzle	Pressure bar	Throw Radius m	Flow lph	Flow lpm	Precip.Rate w/no overlap mm/h
Q 	1.4	1.2	23	0.38	16
	2.1	1.2	27	0.44	19
	2.8	1.4	27	0.45	15
	3.4	1.4	27	0.45	15
H 	1.4	1.2	39	0.65	13
	2.1	1.2	41	0.68	16
	2.8	1.4	41	0.68	14
	3.4	1.4	41	0.68	14
F 	1.4	1.2	76	1.27	13
	2.1	1.2	92	1.53	15
	2.8	1.4	103	1.72	14
	3.4	1.4	103	1.72	14

Performance data taken in zero wind conditions

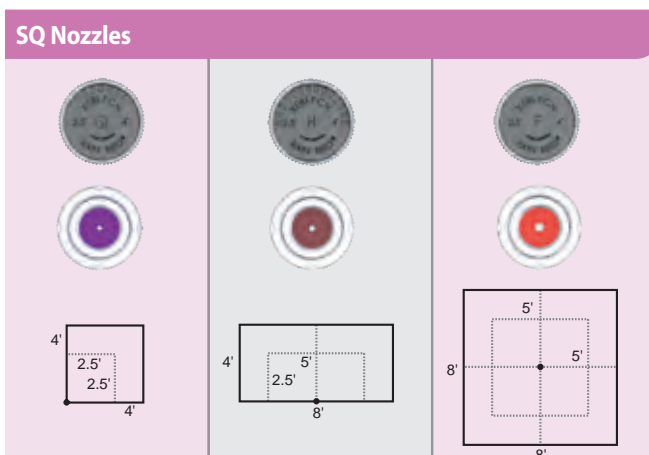

Xeri-Pop™ Micro-Spray

The Xeri-Pop™ Micro-Spray Makes It Easy to Integrate a Durable Micro-Spray into a Low-Volume Irrigation Design

Features

- The only pop-up spray that works in low-volume low-pressure application, and this is the perfect solution to vandal-prone areas
- Xeri-Pops can be installed and located in nearly any location and are ideal for small, odd-shaped planting beds; the 12" version is perfect for annual flower beds
- Xeri-Pops work with Rain Bird 5' and 8' MPR nozzles and SQ Series Nozzles — nozzles with square spray patterns and adjustable throws of 2.5' and 4'
- The Xeri-Pop can operate with 20 to 50 psi base pressure when water is supplied via 1/4" Distribution Tubing (XQ)
- The flexibility of 1/4" tubing allows the Xeri-Pop to be easily located and relocated as planting conditions dictate
- A durable, plastic snap-collar (on 4" and 6" models) secures the 1/4" tubing to the outside of the Xeri-Pop case
- The Xeri-Pop's 1/4" Distribution Tubing can readily connect to 1/2" or 3/4" polyethylene tubing or to a multi-outlet manifold (EMT-6XERI). Connections to polyethylene tubing are accomplished with either an SPB-025 1/4" Self-piercing barb Connector or an XBF1CONN 1/4" barb Connector
- External parts are UV-resistant and available in 4", 6" and 12" pop up heights

Operating Range

- Pressure: 20 to 50 psi (1.4 to 3.5 bar)
- Filtration: Depends on nozzle used with Xeri-Pop

Models

- XP-400X: 4-inch pop-up
- XP-600X: 6-inch pop-up
- XP-1200X: 12-inch pop-up

Nozzle Options

- SQ Series Nozzles (page 124)
- 5 Series MPR Nozzle (all configurations)
- 5 Series Plastic Bubbler
- 8 Series MPR Nozzle (8H, 8T and 8Q)

Installing the Xeri-Pop in 4 Easy Steps

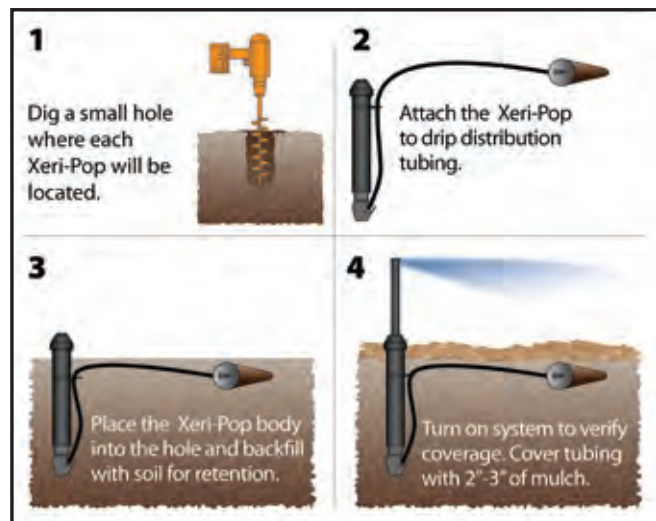

XP-400X



XP-600X

1/4" distribution tube snap collar

1/4" distribution tube inlet



XP-1200X



How to Specify

XP - 600X

Model
Xeri-Pop

Pop-Up Height
400X = 4" Pop-up
600X = 6" Pop-up
1200X = 12" Pop-up

Always install a PCS-010, -020, 030, or -040 Pressure-Compensating Screen whenever a 5B Bubbler Nozzle is installed on a Xeri-Pop.

Xeri-Bubblers™

Ideal for Shrub Plantings, Trees, Containers, and Flower Beds

Features

- Adjust flow and radius by turning outer cap
- Clean by completely unscrewing cap from base unit
- Three convenient installation connections available for design flexibility: 10-32 self-tapping thread, 1/4" barb, and 5" spike

Operating Range

- Pressure: 15 to 30 psi (1.0 to 2.1 bar)
- SXB Series flow:
 - 0 to 13 gph (0 to 49.21 l/h) at 30 psi (2.1 bar)
 - 0 to 8.5 gph (0 to 30 l/h) at 15 psi (1 bar)
- UXB Series flow:
 - 0 to 35 gph (0 to 132.48 l/h) at 30 psi (2.1 bar)
 - 0 to 26 gph (0 to 98 l/h) at 15 psi (1 bar)
- Max flow varies with inlet pressure

Models

- SXB-180: Half-circle, 5 streams, 10-32 thread
- SXB-180-025: Half-circle, 5 streams, 1/4" barb
- SXB-180-SPYK: Half-circle, 5 streams, 5" spike; includes barb x barb coupler
- SXB-360: Full-circle, 8 streams, 10-32 thread
- SXB-360-025: Full-circle, 8 streams, 1/4" barb
- SXB-360-SPYK: Full-circle, 8 streams, 5" spike includes barb x barb coupler
- UXB-360: Full-circle, umbrella, 10-32 thread
- UXB-360-025: Full-circle, umbrella, 1/4" barb
- UXB-360-SPYK: Full-circle, umbrella, 5" spike includes barb x barb coupler

How to Specify

SXB - 180 - 025

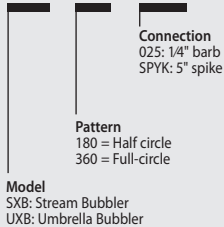

WETTING PATTERNS

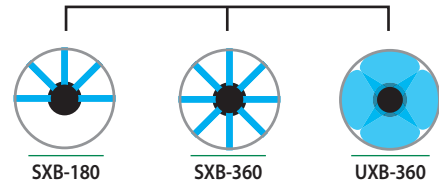

BARB

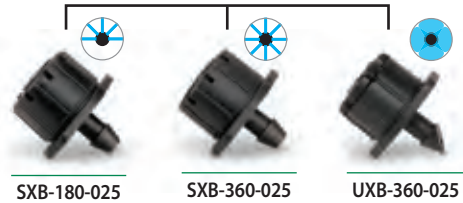

10-32 THREADS

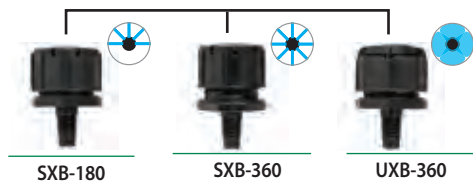

SPIKE



Xeri-Bubbler Performance

Pressure		SXB Flow Rate 360° and 180°		SXB 360° Diameter		SXB 180° Radius		UXB 360° Flow Rate		UXB 360° Diameter	
psi	bar	gph	lph	ft.	m.	ft.	m.	gph	lph	ft.	m.
30	2.1	0 - 13	0 - 49	0 - 3	0 - 0.9	0 - 2.2	0 - 0.67	0 - 35	0 - 132	0 - 2	0 - 0.58
20	1.4	0 - 10.5	0 - 40	0 - 2	0 - 0.6	0 - 1.5	0 - 0.46	0 - 30	0 - 113	0 - 1	0 - 0.30
15	1	0 - 8.5	0 - 32	0 - 1.2	0 - 0.4	0 - 1.2	0 - 0.38	0 - 27	0 - 98	0 - 0.7	0 - 0.21

Xeri-Sprays™ and Misters

Ideal for Ground Cover, Mass Plantings, Annual Flower Beds, and Containers

Features

- Adjust flow/radius by turning integral ball valve
- Uniform emission pattern provides excellent distribution
- 10-32 self-tapping threads fit into ½" x 10-32 adapter (10-32A); 1800 Xeri-Bubbler™ adapter (XBA-1800); and PolyFlex Riser (PFR-12)

Operating Range

- Flow: 0 to 31 gph (0 to 117.34 l/h)
- Pressure: 10 to 30 psi (0.75 to 2.1 bar)
- Radius: 0 to 13.4 feet (0 to 4.1 m) full-circle; 0 to 10.6 feet (0 to 3.2 m) quarter- and half-circle

Models

- XS-090: Quarter-circle, spray
- XS-180: Half-circle, spray
- XS-360: Full-circle, stream spray
- X360 ADJMST: Full-circle, mist

Xeri-Spray™ 360° True Spray

Ideal for Mass Plantings, Ground Cover, Annual Flower Beds and Containers

Features

- True micro-spray with full-circle fan spray pattern
- Adjust flow/radius by turning outer cap
- Three convenient installation connections for design flexibility: 10-32 self-tapping thread, ¼" barb and 5" spike
- Easily cleaned by completely unscrewing cap from base unit

Operating Range

- Flow: 0 to 24.5 gph (0 to 92.7 l/h) at 30 psi (200 kPa)
- Flow: 0 to 17 gph (0 to 64 l/h) at 15 psi (100 kPa)
- Pressure: 15 to 30 psi (1.0 to 2.1 bar)
- Radius: 0 to 6.7 feet (0 to 2.0 m)

Models

- XS-360TS: 10-32 threads
- XS-360TS-025: ¼" barb
- XS-360TS-SPYK: 5" spike; includes barb x barb coupler

WETTING PATTERNS

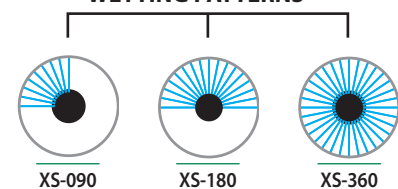

XS-090

XS-180

XS-360



XS-090

XS-180

XS-360



X360 ADJMST

WETTING PATTERN



XS-360TS



XS-360TS-025



XS-360TS



XS-360TS-SPYK

Xeri-Sprays™ and Misters Performance

Pressure		Flow		XS-90 Radius of throw		XS-180 Radius of throw		XS-360 Radius of throw		360 Mister Radius of throw	
psi	bar	gph	l/h	ft.	m.	ft.	m.	ft.	m.	ft.	m.
10	0.7	0 - 16.7	0 - 63.21	0 - 6.4	0 - 2.0	0 - 6.7	0 - 2.0	0 - 9.2	0 - 2.8	0 - 1.5	0 - 0.46
15	1.0	0 - 21.0	0 - 79.49	0 - 8.1	0 - 2.5	0 - 8.1	0 - 2.5	0 - 11.3	0 - 3.4	0 - 1.3	0 - 0.40
20	1.4	0 - 24.5	0 - 92.73	0 - 9.4	0 - 2.9	0 - 9.5	0 - 2.9	0 - 12.9	0 - 3.9	0 - 1.5	0 - 0.44
25	1.7	0 - 28.0	0 - 105.98	0 - 9.8	0 - 3.0	0 - 10.1	0 - 3.1	0 - 13.2	0 - 4.0	0 - 1.4	0 - 0.43
30	2.1	0 - 31.0	0 - 117.34	0 - 10.3	0 - 3.1	0 - 10.6	0 - 3.2	0 - 13.4	0 - 4.1	0 - 1.3	0 - 0.40

Diffuser Bug Cap

Features

- Prevents bugs and other debris from clogging 1/4" Distribution Tubing
- Barbed inlet fits into 1/4" Distribution Tubing (XQ)
- Flanged shield diffuses water to minimize soil erosion at emission point

Operating Range

- Pressure: 0 to 50 psi (0 to 3.5 bar)

Models

- DBC-025: Black



PC Diffuser Cap

Features

- Cap snaps securely onto the PC Module and XB emitter outlet to create bubbler effect and prevent wash out
- Designed for quick and easy installation
- Made of UV-resistant polyethylene material

Models

- PC-DIFFUSER: Black
- PC-DIFF-PPL: Purple to designate non-potable water



Suggested Applications



A. 1/4" tubing, 1/4" stake, PC Module, Diffuser Bug Cap. Used for runs greater than 5 feet from main line

B. 1/4" tubing, 1/4" stake, Diffuser Bug Cap. Used for runs up to 5 feet from main line

(Drip emitter not shown – installed directly into lateral line)

Universal 1/4" Tubing Stake

Features

- Holds 1/4" Distribution Tubing and emitter or Diffuser Bug Cap firmly in place at the root zone of the plant
- Designed to securely hold Rain Bird and other manufacturers' 1/4" Distribution Tubing — 0.16" to 0.18" I.D. and 0.22" to 0.25" O.D.
- Rigid stake featuring a flat enlarged head designed to withstand hammering into tough soil

Note: If emitter is installed at inlet to distribution tubing, use a Diffuser Bug Cap (DBC-025) at outlet of tubing to prevent bugs from clogging tubing and to help hold tubing in place

Model

- TS-025



1/4" Tubing Stake with Cap

Features

- Locking cap holds tubing in place
- Used for holding 1/4" Distribution Tubing (XQ) in place at the plant root zone
- Accepts 1/4" Distribution Tubing from 0.19 O.D. to 0.256 O.D.
- Bug cap included
- Constructed of UV-resistant plastic material

Model

- TS-025WCAP



12" PolyFlex Riser

Features

- 12" riser that is used with any 10-32 threaded emission device to deliver water directly to a plant. These include Xeri-Bugs, PC Modules, Xeri-Bubblers and Xeri-Sprays
- Extremely rugged and reliable – constructed of thick-walled, high-density polyethylene
- Can be used with a riser-stake (RS-025T)

Operating Range

- Pressure: 15 to 50 psi (1.0 to 3.5 bar)

Model

- PFR-12

PFR-12



PolyFlex Riser and Adapter Assemblies

Features

- 12" or 24" riser that is pre-assembled with a 1/2" male threaded base that simplifies installation
- Use with any 10-32 threaded emission device to deliver water directly to a plant. These include Xeri-Bugs, PC Modules, Xeri-Bubblers and Xeri-Sprays
- Newly-designed adapter with larger tabs makes installation quicker and easier; can be used on PVC laterals, or with any 1/2" female threaded adapter
- Adapter made of heavy-duty Marlex®, which requires no Teflon® tape, saving time during installation
- Extremely rugged and reliable PolyFlex Riser constructed of thick-walled, high-density polyethylene

Operating Range

- Pressure: 15 to 50 psi (1.0 to 3.5 bar)

Models

- PFR-FRA: 12" (30.5 cm) PolyFlex Riser and adapter
- PFR-FRA24: 24" (61.0 cm) PolyFlex Riser and adapter

Use with SQ-ADP (SQ PolyFlex riser adapter, p. 124)



PFR-FRA



PolyFlex Riser and Stake Assembly

Features

- 12" riser that is pre-assembled with a 7" (17.8 cm) stake
- Use with any 10-32 threaded emission device to deliver water directly to a plant. These include Xeri-Bugs, PC Modules, Xeri-Bubblers and Xeri-Sprays
- Saves time and money when installing a low-volume irrigation system
- Extremely rugged and reliable PolyFlex Riser constructed of thick-walled, high-density polyethylene

Operating Range

- Pressure: 15 to 50 psi (1.0 to 3.5 bar)

Model

- PFR-RS: 12" (30.5 cm) PolyFlex Riser and 7" (17.8 cm) stake

PFR-RS



Riser Stake-Threaded

Features

- Rugged 5" (12.7 cm) stake for use with PolyFlex Risers
- Constructed of UV-resistant plastic material
- Barbed side inlet accepts 1/4" Distribution Tubing (XQ)
- 10-32 threaded outlet permits easy threading of 12" (30.5 cm) PolyFlex Riser (PFR-12)

Operating Range

- Pressure: 15 to 50 psi (1.0 to 3.5 bar)

Model

- RS-025T

RS-025T



10-32 Thread Adapter

Features

- Inlet: 1/2" FPT that screws onto any 1/2" MPT riser
- Outlet: 10-32 threads that accept Xeri-Bugs, PC Modules, Xeri-Bubblers and Xeri-Sprays with 10-32 threads
- Constructed of UV-resistant plastic material

Operating Range

- Pressure: 15 to 50 psi (1.0 to 3.5 bar)

Model

- 10-32A

10-32A



1800 Xeri-Bubbler Adapter

Features

- Inlet: 1/2" female threads that screw onto a Rain Bird 1800 series or UNI-Spray or shrub adapter
- Outlet: 10-32 threads that accept any emission device with 10-32 threads including Xeri-Bugs, PC Modules, Xeri-Bubblers and Xeri-Sprays
- Sits at grade when installed on a spray head for a robust installation

Operating Range

- Pressure: 15 to 50 psi (1.0 to 3.5 bar)

Model

- XBA-1800

XBA-1800





Drip Irrigation

RWS (Root Watering System)

Root Watering System promotes deep root growth, healthy tree development, and accelerated growth

Features and Benefits

- Subsurface aeration and irrigation prevents tree and shrub transplant shock
- Highest efficiency solution for tree irrigation - up to 95% emission uniformity with minimal wind, evaporation, or edge control losses
- Aesthetically designed subsurface bubbler contributes to a landscape's natural appearance
- Locking grate at grade deters vandals
- Helps prevent shallow root growth and hardscape damage
- Aesthetically attractive below grade installation
- Self-contained and factory assembled units for assured reliability (10", 18" and 36" sizes)

For the RWS Model:

- 4" (10.2 cm) retaining cap and vandal resistant locking grate tops a 36" (91.4 cm) semi-rigid mesh tube
- Factory installed swing assemblies (excluding RWS) with a 1401 (0.25 gpm; 0.95 l/m), 1402 (0.5 gpm; 1.9 l/m), or 1404 (1.00 gpm; 3.8 l/m) bubbler on a fixed riser makes connecting to lateral lines easy
- Options: Check valve to keep lines from draining (10 ft. min holdback)
Sand sock for use in fine soils

For the RWS - Mini:

- 4" (10.2 cm) retaining cap and vandal resistant locking grate tops a 18" (45.7 cm) semi-rigid mesh tube
- Factory installed ½" spiral barb elbow with a 1401 or 1402 bubbler makes connecting to lateral lines easy
- Options: Check valve to keep lines from draining
Sand sock for use in fine soils

For the RWS - Supplemental:



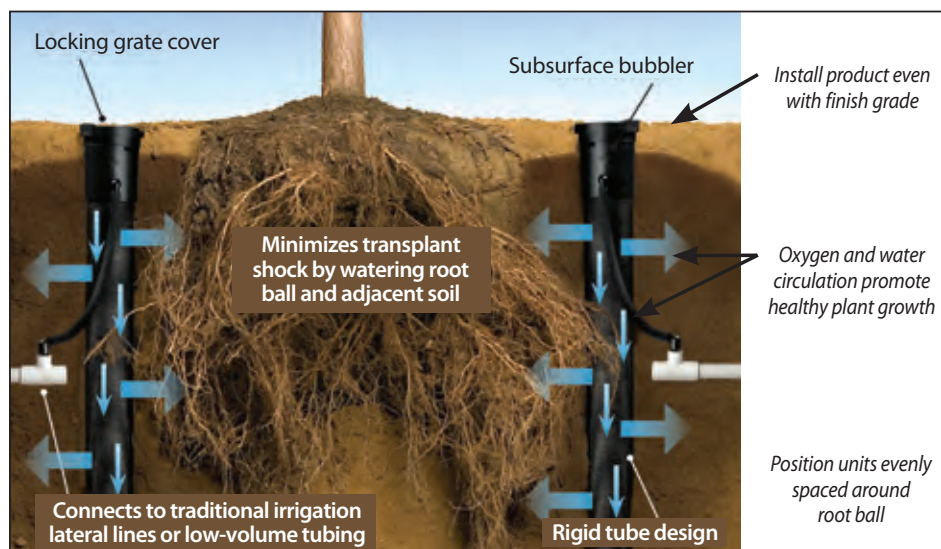























- 2" (5.1 cm) snap-on cap and base cap enclose a 10" (25.4 cm) semi-rigid mesh tube
- Factory installed ½" spiral barb elbow with PCT or 1401 bubbler makes connecting to lateral lines easy
- Options: Check valve to keep lines from draining
Sand sock for use in fine soils

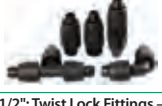
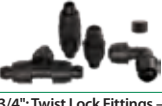

Models /Specifications				
Model	Bubbler	Check Valve*	Swing Assembly w/ ½" (15/21) M NPT inlet	Spiral Barb Elbow w/ ½" (15/21) M NPT inlet
36" Root Watering System (with 4" (10.2 cm) vandal-resistant locking grate)				
RWS	Ideal for ¼" drip tubing or customer provided hardware	–	–	–
RWS-B-C-1401	0.25 gpm (0.95 l/m)	✓ (36")	✓	–
RWS-B-1401	0.25 gpm (0.95 l/m)	–	✓	–
RWS-B-X-1401	0.25 gpm (0.95 l/m)	–	✓ (18" with no elbow)	–
RWS-B-C-1402	0.50 gpm (1.9 l/m)	✓ (36")	✓	–
RWS-B-1402	0.50 gpm (1.9 l/m)	–	✓	–
RWS-B-C-1404	1.00 gpm (3.8 l/m)	✓ (36")	✓	–
18" Root Watering System - Mini (with 4" (10.2 cm) vandal-resistant locking grate)				
RWS-M	Ideal for ¼" drip tubing or customer provided hardware	–	–	–
RWS-M-B-C-1401	0.25 gpm (0.95 l/m)	✓ (18")	–	✓
RWS-M-B-1401	0.25 gpm (0.95 l/m)	–	–	✓
RWS-M-B-C-1402	0.50 gpm (1.9 l/m)	✓ (18")	–	✓
RWS-M-B-1402	0.50 gpm (1.9 l/m)	–	–	✓
10" Root Watering System - Supplemental (with 2" (5.1 cm) snap-on cap and base)				
RWS-S-B-C-PCT5	5.0 gph (19 l/m)	✓ (10")	–	✓
RWS-S-B-C-1401	0.25 gpm (0.95 l/m)	✓ (10")	–	✓
RWS-S-B-1401	0.25 gpm (0.95 l/m)	–	–	✓
Root Watering - Accessories				
RWS-SOCK (Root Watering Sock)				
RWSGRATE (Root Watering System Black Grate for RWS and RWS Mini)				
RWS- GRATE-P (Root Watering System Purple Grate for RWS and RWS Mini)				

* Check Valve is 14 ft. of holdback, or 6 PSI



Tubing	Application	Compatible Fittings	Flow Rates	Emitter Spacing	Coil Lengths	Tubing Diameter	Tube Colors	Special Notes
DRIPLINE								
¼" Landscape Dripline 	Pots and Planter Boxes; Container and Vegetable Gardens; Shrubs; Flowers	   XBF1CONN XBF2EL XBF3TEE	0.8 gph	6" 12"	100'	OD: 0.250" ID: 0.170"		Flexible tubing with clog-resistant built-in filtration
XFD On-Surface Dripline 	On-surface; Shrubs; Flowers	  XF Dripline Insert Fittings Easy Fit Compression Fittings	0.6 gph 0.9 gph	12" 18"	100' 250' 500'	OD: 0.634" ID: 0.536"	Reclaimed Water Reclaimed Water	Extra flexible tubing with clog resistant self-flushing emitter
XFCV; Check Valve; Dripline 	On-Surface; Elevation Changes; Shrubs and Flowers	  XF Dripline Insert Fittings Easy Fit Compression Fittings	0.6 gph 0.9 gph	12" 18"	100' 250' 500'	OD: 0.634" ID: 0.536"		Built-in Emitter Check Valves
XFS Sub-Surface Dripline 	Sub-Surface; Narrow Planting Areas; Turf and Beds	 XF Dripline Insert Fittings	0.4 gph 0.6 gph 0.9 gph	12" 18"	100' 500'	OD: 0.634" ID: 0.536"	Reclaimed Water Reclaimed Water	Copper Shield™ protects emitters from root intrusion
XFS-CV; Sub-Surface; Check Valve; Dripline 	Sub-Surface; Elevation Changes; Turf and Beds	 XF Dripline Insert Fittings	0.6 gph 0.9 gph	12" 18"	100' 250' 500'	OD: 0.634" ID: 0.536"	Reclaimed Water Reclaimed Water	Copper Shield™ protects emitters from root intrusion 10' Emitter Check Valves
BLANK TUBING								
XQ ¼" Distribution Tubing 	Extend emitter outlets to desired location	   XBF1CONN XBF2EL XBF3TEE	—	—	100' 1,000' 1,000' (in bucket)	OD: 0.250" ID: 0.170"		Flexibility of Vinyl with hold of Poly
XBS Black Stripe Tubing 	Five Color Stripe Choices Shrubs Flowers	  1/2": Twist Lock Fittings - 600 Series 3/4": Twist Lock Fittings - 800 Series	—	—	100' 500' 500'	½" OD: 0.700" ½" ID: 0.600" ½" OD: 0.705" ½" ID: 0.615" ¾" OD: 0.940" ¾" ID: 0.820"	Reclaimed Water Reclaimed Water Reclaimed Water	Black tube with colored stripes to differentiate zones
XT-700 Distribution Tubing 	Thick-walled but Flexible Shrubs Flowers	 1/2": Twist Lock Fittings - 600 Series	—	—	100' 500'	OD: 0.700" ID: 0.580"		Thick-walled, flexible tubing resists kinks
XF Series Blank Tubing 	Shrubs Flowers	  XF Dripline Insert Fittings Easy Fit Compression Fittings	—	—	100' 250' 500'	OD: 0.634" ID: 0.536"	Reclaimed Water Reclaimed Water	Extra Flexible
QF Dripline Header 	Pre-fabricated header for dripline installations	  Twist Lock Fittings - 800 Series (For QF Header - ¾") Twist Lock Fittings - 1000 Series (For QF Header - 1")	—	Elbow Spacing: 12" 18"	100'	3/4" OD: 0.940" 3/4" ID: 0.820" 1" OD: 1.200" 1" ID: 1.060"	Reclaimed Water	Elbows rotate 360° and incorporate a protective ring

XFD On-Surface Dripline

The Most Flexible, Pressure-Compensating In-line Emitter Tubing Available to Irrigate Ground Cover, Dense Plantings, Hedge Rows and More

Features

- Extra flexible tubing for fast, easy installation
- Dual-layered tubing (brown over black or purple over black) provides unmatched resistance to chemicals, UV damage and algae growth
- Patent pending emitter design provides for increased reliability
- Longer lateral runs than competition
- Unique material offers significantly greater flexibility, allowing tighter turns with fewer elbows for easier installation
- Choice of flow rates, spacing and coil lengths provides design flexibility for a variety of non-turfgrass applications
- Use an Air/Vacuum Relief Valve Kit when installation is below soil (pg 147)

Operating Range

- Pressure: 8.5 to 60 psi (0.58 to 4.1 bar)
- Flow rates: 0.6 gph and 0.9 gph (2.3 l/h and 3.5 l/h)
- Temperature: Water up to 100° F (37.8C); Ambient up to 125° F (51.7C)
- Required filtration: 120 mesh

Specifications

- Outside diameter: 0.634" (16.1 mm)
- Inside diameter: 0.536" (13.6 mm)
- Wall thickness: 0.049" (1.2 mm)
- Spacing: 12" or 18"
- Lengths: 100', 250', and 500' coils
- Use with XF Dripline Insert Fittings or Rain Bird Easy Fit Compression Fittings



XFD Dripline



Also available in Purple and Purple Stripe



XFD Dripline Offers Improved Flexibility for Kink Resistance and Easy Installation. The Dripline Can Bend Down to a 3" Radius Without Kinking.

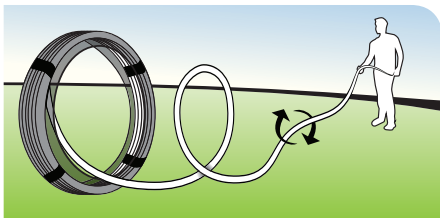

Self-Dispensing Coil Reduces Layout Time and Improves Ease of Installation



XFD Dripline

How to Specify

XFD - P - 09 - 12 - 100	
Model XFD Dripline	Length of Tubing 100 = 100' (30.5 m) 250 = 250' (76.2 m) 500 = 500' (152.4 m)
Optional P = Purple PS = Purple stripe	Emitter Spacing 12 = 12" (30.5 cm) 18 = 18" (45.7 cm)
Flow Rate 06 = .61 gph (2.3 l/h) 09 = .92 gph (3.5 l/h)	

Compatible Fittings



XF Dripline Insert Fittings (pg. 145)



Easy Fit Compression Fittings (pg. 146)

XFD On-Surface Dripline Models

Model	Flow gph	Spacing in.	Coil Length ft.
XFD-06-12-100	0.60	12	100
XFD-06-12-250	0.60	12	250
XFD-06-12-500	0.60	12	500
XFD-06-18-100	0.60	18	100
XFD-06-18-250	0.60	18	250
XFD-06-18-500	0.60	18	500
XFD-09-12-100	0.90	12	100
XFD-09-12-250	0.90	12	250
XFD-09-12-500	0.90	12	500
XFD-09-18-100	0.90	18	100
XFD-09-18-250	0.90	18	250
XFD-09-18-500	0.90	18	500
XFDP-06-12-500 (Purple)	0.60	12	500
XFDP-06-18-500 (Purple)	0.60	18	500
XFDP-09-12-500 (Purple)	0.90	12	500
XFDP-09-18-500 (Purple)	0.90	18	500
XFDP-06-12-500 (Purple Stripe)	0.60	12	500
XFDP-06-18-500 (Purple Stripe)	0.60	18	500
XFDP-09-12-500 (Purple Stripe)	0.90	12	500
XFDP-09-18-500 (Purple Stripe)	0.90	18	500

XFD On-Surface Dripline Models

METRIC

Model	Flow l/h	Spacing cm	Coil Length m
XFD-06-12-100	2.30	30.5	30.5
XFD-06-12-250	2.30	30.5	76.5
XFD-06-12-500	2.30	30.5	152.4
XFD-06-18-100	2.30	45.7	30.5
XFD-06-18-250	2.30	45.7	76.5
XFD-06-18-500	2.30	45.7	152.4
XFD-09-12-100	3.40	30.5	30.5
XFD-09-12-250	3.40	30.5	76.5
XFD-09-12-500	3.40	30.5	152.4
XFD-09-18-100	3.40	45.7	30.5
XFD-09-18-250	3.40	45.7	76.5
XFD-09-18-500	3.40	45.7	152.4
XFDP-06-12-500 (Purple)	2.30	30.5	152.4
XFDP-06-18-500 (Purple)	2.30	45.7	152.4
XFDP-09-12-500 (Purple)	3.40	30.5	152.4
XFDP-09-18-500 (Purple)	3.40	45.7	152.4
XFDP-06-12-500 (Purple Stripe)	2.30	30.5	152.4
XFDP-06-18-500 (Purple Stripe)	2.30	45.7	152.4
XFDP-09-12-500 (Purple Stripe)	3.40	30.5	152.4
XFDP-09-18-500 (Purple Stripe)	3.40	45.7	152.4

For dripline applications requiring 0.4 gpm flow rate, use XF Series Dripline, page 139.

XFD On-Surface Dripline Maximum Lateral Lengths (Feet)

Inlet Pressure psi	Maximum Lateral Length (feet)			
	12" Spacing		18" Spacing	
	Nominal Flow (gph):		Nominal Flow (gph):	
	0.6	0.9	0.6	0.9
15	273	155	314	250
20	318	169	353	294
30	360	230	413	350
40	395	255	465	402
50	417	285	528	420
60	460	290	596	455

XFD On-Surface Dripline Maximum Lateral Lengths (meters)

Inlet Pressure bar	Maximum Lateral Length (meters)			
	30.5 cm		45.7 cm	
	Nominal Flow (l/h):		Nominal Flow (l/h):	
	2.3	3.4	2.3	3.4
1.0	83.2	47.2	95.7	76.2
1.4	96.9	51.5	107.6	89.6
2.1	109.7	70.1	125.9	106.7
2.8	120.4	77.7	141.7	122.5
3.5	127.1	86.9	160.9	128.0
4.1	140.2	88.4	181.7	138.7

XFCV Dripline with Check Valve

Rain Bird® XFCV Dripline with a heavy-duty 3.5 psi check valve for on-surface applications adds a valuable member to the Rain Bird XF Series of Dripline. The XFCV is the most effective dripline in the industry and is ideal for areas where no other dripline will work. When used in applications where elevation changes exist, the patent-pending check valve keeps the dripline charged, holding 8 feet of hold back. Rain Bird's XFCV offers better uniformity and helps to prevent over-watering at the low-point in the zone, avoiding puddling and water draining from the dripline.

It accepts Rain Bird Easy Fit Compression Fittings, XF Dripline Barbed Insert Fittings and other 17 mm barbed insert fittings.

Features

Simple

- Rain Bird's patent-pending 3.5 psi check valve technology keeps the dripline charged with water at all times, increasing uniformity of watering, and conserves water by eliminating the need to recharge the line at the beginning of each watering cycle
- Through the use of a proprietary tubing material, the XFCV Dripline with heavy-duty check valve is the most flexible dripline tubing in the industry, making it the easiest dripline to design with and install
- Rain Bird's low-profile emitter design reduces in-line pressure loss, allowing longer lateral runs, simplifying design and reducing installation time
- Variety of emitter flow rates, emitter spacing and coil lengths provide design flexibility for on-surface areas with or without elevation changes

Made with Recycled Content

- All Rain Bird XF Dripline (XFD, XFS, XFCV, XFS-CV) qualify for LEED credit 4.2 because they contain at least 20% Polyethylene post consumer recycled material by cost. These come in an assortment of coil sizes, flow rates and emitter spacing

Reliable

- The pressure-compensating emitter design provides a consistent flow over the entire lateral length ensuring higher uniformity for increased reliability in the pressure range of 20 to 60 psi

Durable

- Dual-layered tubing (brown over black) provides unmatched resistance to chemicals, algae growth and UV damage

Grit Tolerant

- Rain Bird's proprietary emitter design resists clogging by use of an extra wide flow path combined with a self-flushing action



XFCV Dripline for Elevated Applications

With XFCV's built-in 3.5 check valve, all lines are kept charged and up to 8 feet of water is held back

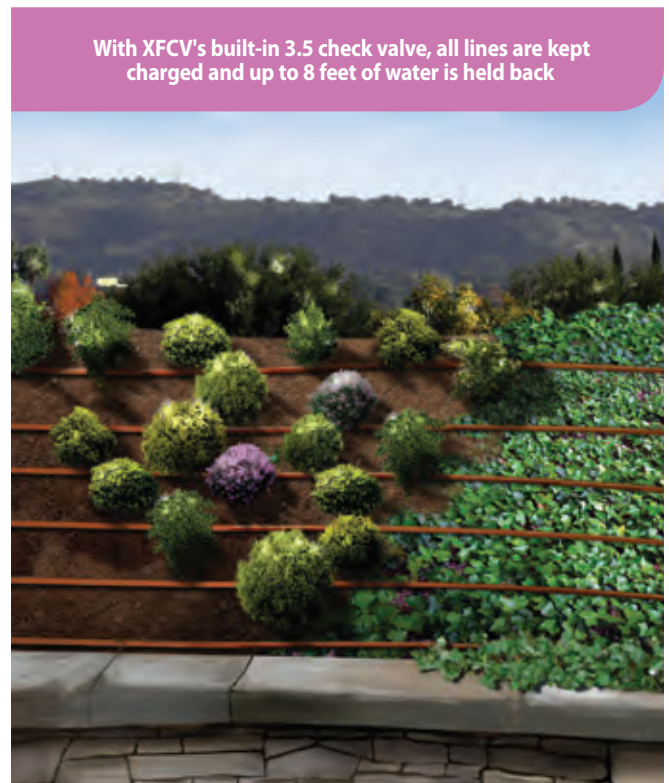

Drip Irrigation

How to Specify

XFCV - 06 - 12 - 100

<p>Model XFCV Dripline with Heavy-Duty Check Valve</p>	<p>Length of Tubing 100 = 100' (30.5 m) 250 = 250' (76.2 m) 500 = 500' (152.4 m)</p> <p>Emitter Spacing 12 = 12" (30.5 cm) 18 = 18" (45.7 cm)</p> <p>Flow Rate 06 = .61 gph (2.3 l/h) 09 = .92 gph (3.5 l/h)</p>
----------------------------------------------------------------------------	----------------------------------------------------------------------------------------------------------------------------------------------------------------------------------------------------------------------------------------------

For reclaimed water, use XFS-CV

Operating Range

- Opening Pressure: 14.5 psi
- Pressure: 20 to 60 psi (1.38 to 4.14 bar)
- Flow rates: 0.6 and 0.9 gph (2.3 l/hr and 3.5 l/hr)
- Temperature:
 - Water: Up to 100°F (37.8° C)
 - Ambient: Up to 125°F (51.7° C)
- Required Filtration: 120 mesh

Specifications

- Dimensions:
 - OD: 0.634" (16mm)
 - ID: 0.536" (13.6mm);
- Thickness: 0.049" (1.2mm)
- 12" & 18" (30.5 cm, 45.7 cm) spacing
- Available in 100', 250', and 500' (30.5 m, 76.2 m, and 152.4 m) coils
- Coil Color: Brown
- Use with XF Dripline Insert Fittings or Rain Bird Easy Fit Compression Fittings

Compatible Fittings



XF Dripline Insert Fittings (pg. 145)



Easy Fit Compression Fittings (pg. 146)

XFCV Dripline Models

Model	Flow gph	Spacing in.	Coil Length ft.
XFCV-06-12-100	0.60	12	100
XFCV-06-12-250	0.60	12	250
XFCV-06-12-500	0.60	12	500
XFCV-06-18-100	0.60	18	100
XFCV-06-18-250	0.60	18	250
XFCV-06-18-500	0.60	18	500
XFCV-09-12-100	0.90	12	100
XFCV-09-12-250	0.90	12	250
XFCV-09-12-500	0.90	12	500
XFCV-09-18-100	0.90	18	100
XFCV-09-18-250	0.90	18	250
XFCV-09-18-500	0.90	18	500

XFCV Dripline Models

METRIC

Model	Flow gph	Spacing in.	Coil Length ft.
XFCV-06-12-100	2.30	30.5	30.5
XFCV-06-12-250	2.30	30.5	76.2
XFCV-06-12-500	2.30	30.5	152.4
XFCV-06-18-100	2.30	30.5	30.5
XFCV-06-18-250	2.30	30.5	76.2
XFCV-06-18-500	2.30	30.5	152.4
XFCV-09-12-100	2.30	30.5	30.5
XFCV-09-12-250	2.30	30.5	76.2
XFCV-09-12-500	2.30	30.5	152.4
XFCV-09-18-100	2.30	30.5	30.5
XFCV-09-18-250	2.30	30.5	76.2
XFCV-09-18-500	2.30	30.5	152.4

XFCV Dripline Maximum Lateral Lengths (Feet)

Inlet Pressure psi	Maximum Lateral Length (feet)			
	12" Spacing		18" Spacing	
	Nominal Flow (gph):		Nominal Flow (gph):	
	0.6	0.9	0.6	0.9
20	192	136	254	215
30	289	205	402	337
40	350	248	498	416
50	397	281	573	477
60	436	309	637	529

XFCV Dripline Maximum Lateral Lengths (Meters) METRIC

Inlet Pressure bar	Maximum Lateral Length (meters)			
	30.5 cm		45.7 cm	
	Nominal Flow (l/h):		Nominal Flow (l/h):	
	2.3	3.4	2.3	3.4
1.4	59	41	77	66
2.1	88	63	123	103
2.8	107	76	152	127
3.5	121	86	175	145
4.1	133	94	194	161

XFS Sub-Surface Dripline with Copper Shield™ Technology

Sub-Surface Drip Irrigation (SDI) perfect for small, narrow and tight planting areas, switchbacks, as well as all turf landscapes

Rain Bird® XFS Sub-Surface Copper-Colored Dripline with Copper Shield™ Technology is the latest innovation in the Rain Bird Landscape Drip Family. Rain Bird's patent-pending Copper Shield Technology protects the emitter from root intrusion, creating a long-lasting, low maintenance sub-surface drip irrigation system for use under turf grass or shrub and groundcover areas.

A proprietary tubing material makes the XFS Sub-Surface Dripline with Copper Shield the most flexible tubing in the industry, and the easiest sub-surface dripline to design with and install.

Features

Simple

- Rain Bird's low-profile emitter design reduces in-line pressure loss, allowing longer lateral runs, simplifying design and reducing installation time
- Variety of emitter flow rates, emitter spacing and coil lengths provide design flexibility for either sub-surface turf or sub-surface shrub and groundcover applications

Reliable

- XFS Sub-Surface Dripline emitters are protected from root intrusion by Rain Bird's patent-pending Copper Shield™ Technology resulting in a system that does not require maintenance or replacement of chemicals to prevent root intrusion
- The pressure-compensating emitter design provides a consistent flow over the entire lateral length ensuring higher uniformity for increased reliability in the pressure range of 8.5 to 60 psi

Durable

- Dual-layered tubing (copper over black) provides unmatched resistance to chemicals, algae growth and UV damage
- Grit Tolerant: Rain Bird's proprietary emitter design resists clogging by use of an extra-wide flow path combined with a self-flushing action

Operating Range

- Pressure: 8.5 to 60 psi (0.58 to 4.14 bar)
- Flow rates: 0.4 gph, 0.6, and 0.9 gph (1.6 l/h, 2.3 l/hr and 3.5 l/hr)
- Temperature:
 - Water: Up to 100°F (37.8° C)
 - Ambient: Up to 125°F (51.7° C)
- Required Filtration: 120 mesh

Specifications

- Dimensions: OD: 0.634" (16mm); ID: 0.536" (13.6mm); Thickness: 0.049" (1.2mm)
- 12" and 18" (30.5 cm and 45.7 cm) spacing
- Available in 100' and 500' (30.5 m and 152.4 m) coils
- Coil Color: Copper
- Use with XF Dripline Insert Fittings



XFS Sub-Surface Dripline



XFS Sub-Surface Dripline with Copper Shield™ Technology



XFS Dripline offers increased flexibility for easy installation



Irrigation Association Show Winner

How to Specify

XFS - P - 09 - 12 - 100	
Optional P = Purple PS = Purple stripe	Length of Tubing 100 = 100' (30.5 m) 500 = 500' (152.4 m)
Model XFS Sub-Surface Dripline	Emitter Spacing 12 = 12" (30.5 cm) 18 = 18" (45.7 cm)
Flow Rate 04 = .42 gph (1.6 l/h) 06 = .61 gph (2.3 l/h) 09 = .92 gph (3.5 l/h)	

XF Dripline Insert Fittings

XF Dripline Insert Fittings offer a unique barb design to reduce insertion force and still retain a secure fit (p. 145)



XF Dripline Insert Fittings (pg. 145)

We recommend using the XF Insertion Tool (FITINS-TOOL) which lowers the effort required to insert each fitting by 50% (p. 147)



FITINS-TOOL

XF Sub-Surface Dripline Models

Model	Flow gph	Spacing in.	Coil Length ft.
XFS-04-12-100	0.42	12	100
XFS-04-12-500	0.42	12	500
XFS-04-18-100	0.42	18	100
XFS-04-18-500	0.42	18	500
XFS-06-12-100	0.60	12	100
XFS-06-12-500	0.60	12	500
XFS-06-18-100	0.60	18	100
XFS-06-18-500	0.60	18	500
XFS-09-12-100	0.90	12	100
XFS-09-12-500	0.90	12	500
XFS-09-18-100	0.90	18	100
XFS-09-18-500	0.90	18	500
XFSP-04-12-500 (Purple)	0.42	12	500
XFSP-06-12-500 (Purple)	0.60	12	500
XFSP-06-18-500 (Purple)	0.60	18	500
XFSP-09-12-500 (Purple)	0.90	12	500
XFSP-09-18-500 (Purple)	0.90	18	500
XFSPS-04-12-5 (Purple Stripe)	0.42	12	500
XFSPS-04-18-5 (Purple Stripe)	0.42	18	500
XFSPS-06-12-5 (Purple Stripe)	0.60	12	500
XFSPS-06-18-5 (Purple Stripe)	0.60	18	500
XFSPS-09-12-5 (Purple Stripe)	0.90	12	500
XFSPS-09-18-5 (Purple Stripe)	0.90	18	500

XF Sub-Surface Dripline Models

METRIC

Model	Flow l/h	Spacing cm	Coil Length m
XFS-04-12-100	1.60	30.5	30.5
XFS-04-12-500	1.60	30.5	152.4
XFS-04-18-100	1.60	45.7	30.5
XFS-04-18-500	1.60	45.7	152.4
XFS-06-12-100	2.30	30.5	30.5
XFS-06-12-500	2.30	30.5	152.4
XFS-06-18-100	2.30	45.7	30.5
XFS-06-18-500	2.30	45.7	152.4
XFS-09-12-100	3.50	30.5	30.5
XFS-09-12-500	3.50	30.5	152.4
XFS-09-18-100	3.50	45.7	30.5
XFS-09-18-500	3.50	45.7	152.4
XFSP-04-12-500 (Purple)	1.60	30.5	152.4
XFSP-06-12-500 (Purple)	2.30	30.5	152.4
XFSP-06-18-500 (Purple)	2.30	45.7	152.4
XFSP-09-12-500 (Purple)	3.50	30.5	152.4
XFSP-09-18-500 (Purple)	3.50	45.7	152.4
XFSPS-04-12-5 (Purple Stripe)	1.60	30.5	152.4
XFSPS-04-18-5 (Purple Stripe)	1.60	45.7	152.4
XFSPS-06-12-5 (Purple Stripe)	2.30	30.5	152.4
XFSPS-06-18-5 (Purple Stripe)	2.30	45.7	152.4
XFSPS-09-12-5 (Purple Stripe)	3.50	30.5	152.4
XFSPS-09-18-5 (Purple Stripe)	3.50	45.7	152.4

XF Sub-Surface Dripline Maximum Lateral Lengths (Feet)

Inlet Pressure psi	Maximum Lateral Length (feet)					
	12" Spacing			18" Spacing		
	Nominal Flow (gph):			Nominal Flow (gph):		
	0.42	0.6	0.9	0.42	0.6	0.9
15	352	273	155	374	314	250
20	399	318	169	417	353	294
30	447	360	230	481	413	350
40	488	395	255	530	465	402
50	505	417	285	610	528	420
60	573	460	290	734	596	455

XF Sub-Surface Dripline Maximum Lateral Lengths (meters)

Inlet Pressure bar	Maximum Lateral Length (meters)					
	30.5 cm			45.7 cm		
	Nominal Flow (l/h):			Nominal Flow (l/h):		
	1.6	2.3	3.4	1.6	2.3	3.4
1.0	107.2	83.2	47.2	114	95.7	76.2
1.4	121.6	96.9	51.5	127.1	107.6	89.6
2.1	136.2	109.7	70.1	146.6	125.9	106.7
2.8	148.7	120.4	77.7	161.5	141.7	122.5
3.5	153.9	127.1	86.9	185.9	160.9	128.0
4.1	174.6	140.2	88.4	223.7	181.7	138.7

XFS-CV Dripline with Heavy-Duty Check Valve

NEW

Rain Bird® XFS-CV Dripline with an improved 4.3 psi check valve delivers 10 feet of hold-back – the highest in the industry.

With pure copper chips in every emitter to protect against emitter root intrusion, XFS-CV dripline is an all-in-one dripline suitable for any application – on-surface, sub-surface, sloped or level-grade.

When used in applications where elevation changes exist, the patent-pending check valve keeps the dripline charged with water, delivering better irrigation uniformity while preventing over-watering and puddling at the low-point in the zone.

It accepts Rain Bird XF Dripline Barbed Insert Fittings, RB 600 Series Twist Lock Fittings, and other 17 mm barbed insert fittings.

A proprietary tubing material makes the XFS Sub-Surface Dripline with Copper Shield the most flexible tubing in the industry, and the easiest sub-surface dripline to design with and install.

Features

Simple

- Rain Bird's patent-pending 4.3 psi check valve technology keeps the dripline charged with water at all times, increasing uniformity of watering, and conserves water by eliminating the need to recharge the line at the beginning of each watering cycle
- XFS-CV Sub-Surface Dripline emitters are protected from root intrusion by Rain Bird's patent-pending Copper Shield™ Technology resulting in a system that does not require maintenance or replacement of chemicals to prevent root intrusion. Through the use of a proprietary tubing material, the XFS-CV Dripline with heavy-duty check valve is the most flexible dripline tubing in the industry, making it the easiest dripline to design with and install
- Rain Bird's low-profile emitter design reduces in-line pressure loss, allowing longer lateral runs, simplifying design and reducing installation time
- Variety of standard emitter flow rates, emitter spacing and coil lengths provide design flexibility for sub-surface and on-surface areas with or without elevation changes

Made with Recycled Content

- All Rain Bird XF Dripline (XFD, XFS, XFCV, XFS-CV) qualify for LEED credit 4.2 because they contain at least 20% Polyethylene post consumer recycled material by cost. These come in an assortment of coil sizes, flow rates and emitter spacing

Reliable

- The pressure-compensating emitter design provides a consistent flow over the entire lateral length ensuring higher uniformity for increased reliability in the pressure range of 20 to 60 psi

Durable

- Dual-layered tubing (copper over black) provides unmatched resistance to chemicals, algae growth and UV damage

Grit Tolerant

- Rain Bird's proprietary emitter design resists clogging by use of an extra wide flow path combined with a self-flushing action



XFS-CV Dripline for Elevated Applications

With XFS-CV's built-in 4.3 check valve, all lines are kept charged and up to 10 feet of water is held back



Drip Irrigation



How to Specify

XFS-CV - 06 - 12 - 100

Model	Xeri-Flex	Length of Tubing	100 = 100' (30.5 m)
Subsurface		250 = 250' (76.2 m)	
CV = Check Valve		500 = 500' (152.4 m)	
CVP = Purple		Emitter Spacing	12 = 12" (30.5 cm)
CVPS = Purple Stripe		18 = 18" (45.7 cm)	
Flow Rate		06 = .61 gph (2.3 l/h)	
		09 = .92 gph (3.5 l/h)	

Operating Range

- Opening Pressure: 14.5 psi
- Pressure: 20 to 60 psi (1.38 to 4.14 bar)
- Flow rates: 0.6 and 0.9 gph (2.3 l/hr and 3.5 l/hr)
- Temperature:
 - Water: Up to 100°F (37.8° C)
 - Ambient: Up to 125°F (51.7° C)
- Required Filtration: 120 mesh

Specifications

- Dimensions:
 - OD: 0.634" (16mm)
 - ID: 0.536" (13.6mm);
- Thickness: 0.049" (1.2mm)
- 12" & 18" (30.5 cm, 45.7 cm) spacing
- Available in 100', 250' and 500' (30.5 m, 76.2 m and 152.4 m) coils
- Coil Colors: Copper, purple, purple stripe
- Use with XF Dripline Insert Fittings

XF Dripline Insert Fittings

XF Dripline Insert Fittings offer a unique barb design to reduce insertion force and still retain a secure fit (p. 145)

XF Dripline Insert Fittings (pg. 145)



We recommend using the XF Insertion Tool (FITINS-TOOL) which lowers the effort required to insert each fitting by 50% (p. 147)



FITINS-TOOL

XF-CV Dripline Maximum Lateral Lengths (Feet)

Inlet Pressure psi	Maximum Lateral Length (feet)			
	12" Spacing		18" Spacing	
	Nominal Flow (gph):		Nominal Flow (gph):	
	0.6	0.9	0.6	0.9
20	192	136	254	215
30	289	205	402	337
40	350	248	498	416
50	397	281	573	477
60	436	309	637	529

XF-CV Dripline Maximum Lateral Lengths (Meters)

Inlet Pressure bar	Maximum Lateral Length (meters)			
	30.5 cm		45.7 cm	
	Nominal Flow (l/h):		Nominal Flow (l/h):	
	2.3	3.4	2.3	3.4
1.4	59	41	77	66
2.1	88	63	123	103
2.8	107	76	152	127
3.5	121	86	175	145
4.1	133	94	194	161



QF Dripline Header

A Quick and Flexible Solution to Dripline Headers

The QF Dripline Header is a patent pending product that is the landscape industry's first pre-fabricated header for dripline installations. A Quick and Flexible replacement for a site-built header, the QF Dripline Header saves time and labor expense. Using a proprietary blend of polyethylene, similar to Rain Bird's XF Series Dripline, the QF Dripline header allows installers to simply roll out the header and attach the dripline at guaranteed 12" or 18" spacing. Eliminating the need for measuring, cutting, gluing and taping, the QF Dripline Header saves time and money, making projects more profitable.

Features

- The QF Dripline Header elbows rotate 360° and incorporate a protective ring — preventing damage and ensuring a proper seal.
- The ring also provides leverage to make attaching the dripline easier.
- The rotating barb manages trenching misalignment. Move left or right to accommodate the dripline – no need to re-trench.
- Elbows utilize the same design as Rain Bird's popular XFF Fitting requiring 50% less insertion force, and are compatible with the XFF Fittings Tool.

Specifications

	QF Header - 3/4"	QF Header - 1"
• Outside Diameter:	0.940" (23.9mm)	1.200" (30.5mm)
• Inside Diameter:	0.820" (20.8mm)	1.060" (26.9mm)
• Wall Thickness:	0.060" (1.5mm)	0.070" (1.8mm)

Models

- XQF7512100: XQF 3/4" Dripline Header (12" Spacing 100' Coil)
- XQF7518100: XQF 3/4" Dripline Header (18" Spacing 100' Coil)
- XQF1012100: XQF 1" Dripline Header (12" Spacing 100' Coil)
- XQF1018100: XQF 1" Dripline Header (18" Spacing 100' Coil)
- XQF101210P: XQF 1" Dripline Header (12" Spacing 100' Coil) Purple
- XQF101810P: XQF 1" Dripline Header (18" Spacing 100' Coil) Purple



QF Dripline Header

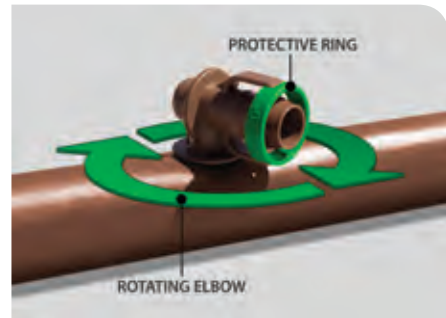

Compatible Fittings



Twist Lock Fittings
800 Series (pg. 144)
(For QF Header - 3/4")



Twist Lock Fittings
1000 Series (pg. 144)
(For QF Header - 1")

How to Specify

XQF - 75 - 12 - 100

Dripline Diameter:	75 = 3/4"	10 = 1"
	Coil Length 100 = 100' (30.5 m) 10P = 100' Purple	
Elbow Spacing	12 = 12" (30.5 cm)	18 = 18" (45.7 cm)
	Model XQF: Xerigation® Quick Flexible	

Twist Lock Fittings

NEW

Durable and Reliable. Rain Bird's NEW Twist Lock Fittings

- Complete line of Twist Lock Fittings to simplify installation of QF Header and Blank Distribution Tubing
- Fittings provide an even tighter seal on tubing by using high quality barbs and twist locking nuts
- Unique barb design reduces insertion force while maintaining a secure fit



Operating Range

- Pressure: 0 to 60 psi (0 to 4.1 bar)

Models

600 SERIES (1/2"):

- TLF-CUPL-0600: Twist Lock Fitting 1/2" Coupler
- TLF-TEE-0600: Twist Lock Fitting 1/2" Tee
- TLF-ELBW-0600: Twist Lock Fitting 1/2" Elbow
- TLF-MPT6-0600: Twist Lock Fitting 1/2" NPT to 1/2" Adaptor
- TLF-MPT8-0600: Twist Lock Fitting 3/4" NPT to 1/2" Adaptor

800 SERIES (3/4"):

- TLF-CUPL-0800: Twist Lock Fitting 3/4" Coupler
- TLF-TEE-0800: Twist Lock Fitting 3/4" Tee
- TLF-ELBW-0800: Twist Lock Fitting 3/4" Elbow
- TLF-MPT8-0800: Twist Lock Fitting 3/4" NPT Adaptor
- TLF-CAP-0800: Twist Lock Fitting 3/4" Cap

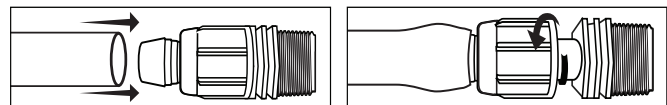

2 Step Installation

1000 SERIES (1"):

- TLF-CUPL-1000: Twist Lock Fitting 1" Coupler
- TLF-TEE-1000: Twist Lock Fitting 1" Tee
- TLF-ELBW-1000: Twist Lock Fitting 1" Elbow
- TLF-MPT1-1000: Twist Lock Fitting 1" NPT Adaptor

	600 Series		800 Series		1000 Series	
	Inches	mm	Inches	mm	Inches	mm
Acceptable Internal Diameter	0.590 to 0.630	15 to 16	0.790 to 0.845	20.0 to 21.5	1.025 to 1.085	26.0 to 27.6
Acceptable Wall Thickness	0.025 to 0.050	0.64 to 1.27	0.045 to 0.065	1.14 to 1.65	0.045 to 0.065	1.14 to 1.65
Compatible Tubing	XT700, 1/2" XBS		3/4" XBS, 3/4" QF Header		1" QF Header	



600 Series
(1/2")



800 Series
(3/4")



1000 Series
(1")

XF Dripline Insert Fittings

Features

- Complete line of 17mm insert fittings to simplify installation of XF Series Dripline
- High quality barbs grab tubing for a secure fit
- Unique barb design to reduce insertion force and still retain a secure fit
- Non-obtrusive colored fittings to compliment natural earth tones

Operating Range

- Pressure: 0 to 50 psi (1.0 to 3.5 bar) if using 60 psi (4.1 bar) clamps will be required

Models

- XFF-COUP: 17mm Barb x Barb Coupling
- XFF-ELBOW: 17mm Barb x Barb Elbow
- XFF-MA-050: 17mm Barb x 1/2" MPT Male Adapter
- XFF-TEE: 17mm Barb x Barb x Barb Tee
- XFF-TMA-050: 17mm Barb x 1/2" MPT x 17mm Barb Tee Male Adapter
- XFF-MA-075: 17mm Barb x 3/4" MPT Male Adapter
- XFF-FA-050: Low profile barb elbow female adapter 17mm x 1/2" FPT
- XFF-TFA-050: Low profile barb tee female adapter 17mm x 1/2" FPT x 17mm
- XFD-CROSS: Barb cross 17mm x 17mm x 17mm x 17mm
- XFD-TFA-075: Barb tee female adapter 17mm x 3/4" FPT x 17mm
- LD16STK: 7 3/4" barbed tubing plastic stake
- FITINS-TOOL: XF Fitting Insertion Tool. Compatible with XFF-COUP, XFF-ELBOW, XFF-TEE, and QF Dripline Header



XF Insert Fittings 17mm

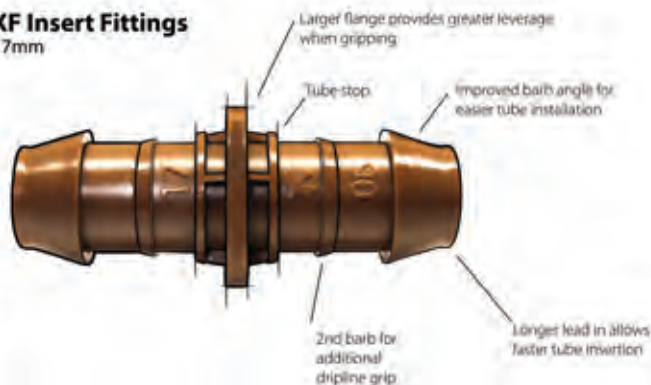

We recommend using the XF Insertion Tool (FITINS-TOOL) which lowers the effort required to insert each fitting by 50% (p. 147)



FITINS-TOOL

Easy Fit Compression Fitting System

Complete system of compression fittings and adapters for all tubing connection needs in a low-volume system

Features

- Reduces inventory costs: Multi-diameter compression fittings work with a wide range of 16mm - 17mm tubing or dripline
- Saves time and effort: 50% less force is required to connect tubing and fittings versus competitive compression fittings. Adapters swivel for easy installation
- Provides increased flexibility: Just three Easy Fit Fittings and five Easy Fit Adapters are needed to make over 160 combinations of connections, accommodating countless installation and maintenance situations
- Works with all 16-17mm dripline and blank tubing
- Patented fittings and adapters are molded from UV-resistant and durable ABS materials
- Removable flush caps can be used to flush end of line and temporarily cap off lines for later expansion
 - Not recommended with subsurface irrigation

Operating Range

- Pressure: 0 to 60 psi (0 to 4.1 bar)
- Accepts tubing with an O.D. of 0.630" to 0.669" (16-17mm)
- Recommended for use above surface only

Models

• Easy Fit Fittings

- MDCF-COUP: Coupling
- MDCF-EL: Elbow
- MDCF-TEE: Tee

• Easy Fit Adapters

- MDCF-50MPT: 1/2" Male Pipe Thread Adapter
- MDCF-75MPT: 3/4" Male Pipe Thread Adapter
- MDCF-50FPT: 1/2" Female Pipe Thread Adapter
- MDCF-75FPT: 3/4" Female Pipe Thread Adapter
- MDCF-75FHT: 3/4" Female Hose Thread Adapter
- MDCF-CAP: Removable Flush Cap For Easy Fit Fittings (Black)
- MDCF-PCAP: Removable Flush Cap For Easy Fit Fittings (Purple, to designate non-potable water)

Note: Easy Fit Adapters are not barbed fittings. They are to be used only with Easy Fit Compression Fittings.

Friction Loss per Fitting

Flow gpm	Loss psi	METRIC	
		Flow l/h	Loss bar
0.00	0.00	0.00	0.00
1.00	0.3	227.1	0.03
2.00	0.64	454.3	0.04
3.00	0.82	681.4	0.06
4.00	1.45	908.5	0.10
5.00	1.90	1135.6	0.13
6.00	2.57	1362.8	0.18



XF Insertion Tool

The XF Insertion Tool reduces the effort required to insert the fittings into the tube by 50%.

Features

- 50% Less effort required to install fittings than without a tool
- Firmly locks fittings into place while inserting Dripline
- Tool helps widen the dripline opening to make the fitting insertion easier
- Solid grip and comfortable fit in hand

Model

- FITINS-TOOL



FITINS-TOOL



The XF Insertion Tool securely locks fittings into place to make inserting dripline easier.



The tool also has a sloped valley to allow room for the dripline when inserting a fitting onto the second side.

The XF Insertion Tool works with the following XF Fittings:



XFF-COUP



XFF-ELBOW



XFF-TEE

Air/Vacuum Relief Valve Kit

Features

- Use with Rain Bird XF-Series or Landscape Dripline inline emitter tubing when installation is below soil*
- Made of quality rust-proof materials
- Fits inside an SEB 7XB emitter box

*Rain Bird recommends XFS dripline with Copper Shield™ for subsurface installations, including installations under turf grass.

Model

- ARV050: 1/2" Air Relief Valve



ARV050

Maximum Length of Dripline Useable with the ARV

1/2" ARV		
Emitter Spacing	0.6 GPH	0.9 GPH
12"	639'	424'
18"	958'	636'
24"	1278'	848'
ARV Capacity		
Total Flow (GPM)	6.5	
Total Flow (GPH)	390	

Maximum Length of Dripline Useable with the ARV METRIC

1/2" ARV		
Emitter Spacing	2.3 l/h	3.4 l/h
0.30 m	195	129
0.46 m	292	194
0.61 m	390	258
ARV Capacity		
Total Flow (l/m)	24.6	
Total Flow (l/h)	1476	

Install Air/Vacuum Relief Valves correctly by:

Locate at the highest point(s) of the dripline zone. Install the valve in an exhaust header or a line that runs perpendicular to the lateral rows to ensure all rows of the dripline can take advantage of the air/vacuum relief valve

Drip System Operation Indicator

Features

- Stem rises 6" for clear visibility
- When stem is extended, drip system is charged to a minimum of 15 psi
- Operational Indicator Kit includes three different indication caps: potable, non-potable, or an adjustable 4-VAN spray nozzle
- Includes 16" of 1/4" distribution tubing with connection fitting pre-installed

Model

- OPERIND



OPERIND

XF Series Blank Tubing

Features:

- Greater flexibility is easier to install and saves time
- Brown color matches landscape and blends with mulch. Matches XF Series Dripline inline emitter tubing
- Compatible with XF Series Dripline (0.536" I.D. x 0.634" O.D.)
- Accepts Rain Bird Easy Fit Compression Fittings, XF Dripline Insert Fittings, and 17mm insert fittings
- Not compatible with 16 mm fittings

Specifications

- Outside Diameter: 0.634" (16.1mm)
- Inside Diameter: 0.536" (13.6mm)
- Wall Thickness: 0.049" (1.2mm)



XFD100

Models:

- XFD100: 100 ft. coil (30m)
- XFD250: 250 ft. coil (76m)
- XFD500: 500 ft. coil (152m)

XF Blank Tubing Friction Loss Characteristics

O.D. .634" I.D. .536"			O.D. 16.1mm I.D. 13.6mm			METRIC
Flow gpm	Velocity fps	Loss psi	Flow l/h	Velocity m/s	Loss bar	
0.50	0.70	0.27	113.56	0.21	0.06	
1.00	1.40	0.97	227.12	0.43	0.22	
1.50	2.10	2.06	340.69	0.64	0.46	
2.00	2.80	3.50	454.25	0.85	0.79	
2.50	3.50	5.29	567.81	1.07	1.20	
3.00	4.20	7.42	681.37	1.28	1.68	
3.50	4.90	9.87	794.94	1.49	2.23	
4.00	5.60	12.64	908.50	1.71	2.86	
4.50	6.30	15.72	1022.06	1.92	3.56	
5.00	7.00	19.11	1135.62	2.13	4.32	
5.50	7.70	22.80	1249.19	2.35	5.16	
6.00	8.40	26.78	1362.75	2.56	6.06	

Psi Loss Per 100 Feet of Pipe (psi/100ft.)

bar Loss per 100 Meters of Pipe (bar/100m)

Note: Use of tubing at flows shown in dark shaded area is not recommended, as velocities exceed 5 ft/sec (1.5 m/s)

Note: Purple and Purple Stripe also available.

XT-700 Distribution Tubing

Durable, thick-walled distribution tubing stands up to harsh conditions and performs well in all climates

Features

- Thick-walled, flexible tubing resists kinks and damage caused by routine landscape maintenance activities
- Extruded from UV-resistant polyethylene resin materials

Operating Range

- Pressure: 0 to 60 psi (0 to 4.1 bar)

Specifications

- Outside diameter: 0.700" (18 mm)
- Inside diameter: 0.580" (15 mm)
- Wall thickness: 0.06" (1.5 mm)



XT-700-100

Models

- XT-700-100: 100-foot coil (30 m)
- XT-700-500: 500-foot coil (152 m)

Note: For both water conservation and appearance, it is recommended that a 2" to 3" (5 to 8 cm) mulch cover be placed on top of the tubing

XT-700 Tubing Friction Loss Characteristics

O.D. .700" I.D. .580"			O.D. 18 mm I.D. 15 mm			METRIC
Flow gpm	Velocity fps	Loss psi	Flow m³/h	Flow l/h	Velocity m/s	Loss bar
0.50	0.61	0.19	0.11	0.03	0.19	0.01
1.00	1.21	0.69	0.23	0.06	0.37	0.05
1.50	1.82	1.45	0.34	0.09	0.56	0.10
2.00	2.43	2.47	0.45	0.13	0.74	0.17
2.50	3.03	3.74	0.57	0.16	0.92	0.26
3.00	3.64	5.24	0.68	0.19	1.11	0.36
3.50	4.24	6.97	0.79	0.22	1.29	0.48
4.00	4.85	8.93	0.91	0.25	1.48	0.62
4.50	5.46	11.10	1.02	0.28	1.67	0.77
5.00	6.06	13.50	1.14	0.32	1.85	0.93
5.50	6.67	16.10	1.25	0.35	2.03	1.11
6.00	7.28	18.92	1.36	0.38	2.22	1.31

Psi Loss per 100 Feet of Pipe (psi/100ft.) bar Loss per 100 Meters of Pipe (bar/100m)

Note: Use of tubing at flows shown in dark shaded area is not recommended, as velocities exceed 5 ft/sec (1.5 m/s)

Compatible Fittings



Twist Lock Fittings
600 Series (pg. 144)
XT-700 & ½" XBS



Twist Lock Fittings
800 Series (pg. 144)
¾" XBS

XBS - Black Stripe Tubing

High quality, flexible tubing for use in any low-volume irrigation system

Features

- 1/2" & 3/4" blank tubing extruded from polyethylene resin materials for consistent durability
- 1/2" tubing is now available in two different sizes: 0.600" I.D. X 0.700" O.D. and 0.615" I.D. X 0.705" O.D.
- Available in five color stripes to differentiate zones
- UV-resistant for installations at or below grade
- Compact coils for easy storage and shipping

Operating Range

- Pressure: 0 to 60 psi (0 to 4.1 bar)

Models

XBS 700 - 1/2" Tubing Models - 600-700

- Outside diameter: 0.700" (17.8 mm)
- Inside diameter: 0.600" (15.2 mm)
- Wall thickness: 0.050" (1.3 mm)
- XBS700G500: 1/2" tubing, 500 foot (152 m) coil with green striping
- XBS700P500: 1/2" tubing, 500 foot (152 m) coil with purple striping

XBS - 1/2" Tubing Models

- Outside diameter: 0.705" (18 mm)
- Inside diameter: 0.615" (15.6 mm)
- Wall thickness: 0.045" (1.2 mm)
- XBS100: 1/2" tubing, 100 foot (30 m) coil with green striping
- XBS500: 1/2" tubing, 500 foot (152 m) coil with green striping
- XBS500B: 1/2" tubing, 500 foot (152 m) coil with black striping
- XBS500R: 1/2" tubing, 500 foot (152 m) coil with red striping
- XBS500Y: 1/2" tubing, 500 foot (152 m) coil with yellow striping
- XBS500P: 1/2" tubing, 500 foot (152 m) coil with purple striping

XBS 940 - 3/4" Tubing Models

- Outside diameter: 0.940" (24 mm)
- Inside diameter: 0.820" (21 mm)
- Wall thickness: 0.060" (1.5 mm)
- XBS940G500: 3/4" tubing, 500 foot (152 m) coil with green striping
- XBS940P500: 3/4" tubing, 500 foot (152 m) coil with purple striping

Note: XBS 940 is also available in 100' coils



Black Stripe Tubing

XBS 700 - 1/2" Tubing Friction Loss Characteristics

O.D. .700" I.D. .600"			O.D. 17.8mm I.D. 15.2mm METRIC		
Flow gpm	Velocity fps	Loss psi	Flow l/h	Velocity m/s	Loss bar
0.50	0.57	0.16	1.89	0.17	0.04
1.00	1.14	0.58	3.79	0.35	0.13
1.50	1.70	1.22	5.68	0.52	0.27
2.00	2.27	2.08	7.57	0.69	0.46
2.50	2.84	3.15	9.46	0.87	0.70
3.00	3.41	4.41	11.36	1.04	0.98
3.50	3.97	5.87	13.25	1.21	1.30
4.00	4.54	7.52	15.14	1.38	1.67
4.50	5.11	9.35	17.03	1.56	2.07
5.00	5.68	11.36	18.93	1.73	2.16
5.50	6.24	13.55	20.82	1.90	3.01
6.00	6.81	15.92	22.71	2.08	3.53

XBS - Tubing Friction Loss Characteristics

O.D. .705" I.D. .615"			O.D. 18 mm I.D. 15.6 mm METRIC		
Flow gpm	Velocity fps	Loss psi	Flow l/h	Velocity m/s	Loss bar
0.50	0.54	0.14	1.89	0.16	0.03
1.00	1.08	0.51	3.79	0.33	0.11
1.50	1.62	1.08	5.68	0.49	0.24
2.00	2.16	1.85	7.57	0.66	0.41
2.50	2.70	2.79	9.46	0.82	0.62
3.00	3.24	3.91	11.36	0.99	0.87
3.50	3.78	5.20	13.25	1.15	1.15
4.00	4.32	6.66	15.14	1.32	1.48
4.50	4.86	8.29	17.03	1.48	1.84
5.00	5.40	10.08	18.93	1.65	2.23
5.50	5.94	12.02	20.82	1.81	2.67
6.00	6.48	14.12	22.71	1.98	3.13

XBS 940 - 3/4" Tubing Friction Loss Characteristics

OD .940" ID .820"			OD 23.9mm ID 20.8mm METRIC		
Flow gpm	Velocity fps	Loss psi	Flow l/h	Velocity m/s	Loss bar
0.50	0.30	0.03	1.89	0.09	0.01
1.00	0.61	0.13	3.79	0.19	0.03
1.50	0.91	0.27	5.68	0.28	0.06
2.00	1.22	0.46	7.57	0.37	0.10
2.50	1.52	0.69	9.46	0.46	0.15
3.00	1.82	0.96	11.36	0.55	0.21
3.50	2.13	1.28	13.25	0.65	0.28
4.00	2.43	1.64	15.14	0.74	0.36
4.50	2.74	2.04	17.03	0.84	0.45
5.00	3.04	2.49	18.93	0.93	0.55
5.50	3.34	2.96	20.82	1.02	0.66
6.00	3.65	3.48	22.71	1.11	0.77
6.50	3.95	4.04	24.61	1.20	0.90
7.00	4.25	4.63	26.50	1.30	1.03
7.50	4.56	5.27	28.39	1.39	1.17
8.00	4.86	5.93	30.28	1.48	1.32
8.50	5.17	6.64	32.18	1.58	1.47
9.00	5.47	7.38	34.07	1.67	1.64
9.50	5.77	8.16	35.96	1.76	1.81
10.00	6.08	8.97	37.85	1.85	1.99

Psi Loss Per 100 Feet of Pipe (psi/100ft.)

Bar Loss per 100 Meters of Pipe (bar/100m)

Note: Use of tubing at flows shown in dark shaded area is not recommended, as velocities exceed 5 ft/sec (1.5 m/s)

XQ 1/4" Distribution Tubing

The strongest and most flexible 1/4" Distribution Tubing available to extend emitter outlets to desirable discharge locations

Features

- Unique blend of polymers that give it the flexibility of vinyl with hold of poly
- New textured finish improves handling
- Self extracting coiling feature makes it easy to use, store and eliminates waste
- Fits over barbed outlet ports and all Xerigation® emission devices and 1/4" transfer fittings
- Extruded from UV-resistant polyethylene resin materials

Specifications

- Outside Diameter: 0.25" (6.3 mm) • Wall Thickness: .04" (1.0 mm)
- Inside Diameter: 0.17" (4.3 mm) • Lengths: 100' and 1000' coils

Operating Range

- Pressure: 0 to 60 psi (0 to 4.1 bar)

Models

- XQ-100: 100-foot (30m) coil 1/4" distribution tubing
- XQ-1000: 1000-foot (305m) coil 1/4" distribution tubing
- XQ-1000-B: 1000-foot (305m) coil 1/4" distribution tubing in a bucket

XQ 1/4" Distribution Tubing Friction Loss Characteristics

O.D. .25" I.D. .17"			O.D. 6.3mm I.D. 4.3mm			METRIC	
Flow gpm	Velocity fps	Loss psi	Flow m ³ /h	Flow l/h	Velocity m/s	Loss bar	
1	0.27	0.16	0.00	3.79	0.08	0.01	
3	0.80	1.24	0.01	11.6	0.24	0.09	
5	1.33	3.20	0.02	18.92	0.41	0.22	
7	1.86	5.97	0.03	26.50	0.57	0.41	
9	2.39	9.50	0.03	34.07	0.73	0.66	
11	2.92	13.79	0.04	41.64	0.89	0.95	
13	3.45	18.75	0.05	49.21	1.05	1.29	
15	3.98	24.43	0.06	56.78	1.21	1.69	
17	4.52	30.80	0.06	64.35	1.38	2.13	
18	4.78	34.23	0.07	68.13	1.46	2.36	
19	5.05	37.83	0.07	71.92	1.54	2.61	
20	5.31	41.60	0.08	75.70	1.62	2.87	
25	6.64	62.86	0.09	94.63	2.03	4.34	
30	7.97	88.08	0.11	113.55	2.43	6.08	

Psi Loss Per 100 Feet of tubing; C=150 Bar Loss per 100 Meters of tubing

Note: Use of tubing at flows shown in dark shaded area is not recommended, as velocities exceed 5 ft/sec (1.5 m/s)



XQ-100 and XQ-1000 1/4" Tubing



XQ-1000-B 1/4" Tubing

1/4" Landscape Dripline

Rain Bird 1/4" Dripline is a perfect choice for small-sized areas such as planter boxes, container gardens, loops around trees, vegetable gardens and shrubs

Features

- Simple to use, as the flexible tubing makes watering pots and container gardens easy
 - Clog resistance through built-in filtration and two outlet holes, 180 degrees apart
- Brown tubing complements Rain Bird XF Dripline
- Works with Rain Bird 1/4" barbed Fittings

Operating Range

- 10 to 40 psi (0.7 to 2.7 bar)
- Flow rate at 30 psi (2.0 bar): 0.8gph (3.0 l/h)
- Required filtration: 200 mesh (75 micron)

Specifications

- Outside diameter: 0.250" (6 mm)
- Inside diameter: 0.170" (4 mm)
- Wall thickness: 0.040" (1 mm)
- Spacing: 6" or 12" (15.25 cm and 30.5 cm)
- Length: 100' (30.5 m) coils

Models

- LDQ0806100 • LDQ0812100



LDQ-08-06-100

Flow Characteristics

Model	Flow at 30 psi		Spacing		Coil Length	
	gph	l/h	in.	cm	ft.	m
LDQ0806100	0.8	3.0	6	15.25	100	30.50
LDQ0812100	0.8	3.0	12	30.5	100	30.5

1/4" Landscape Dripline Performance

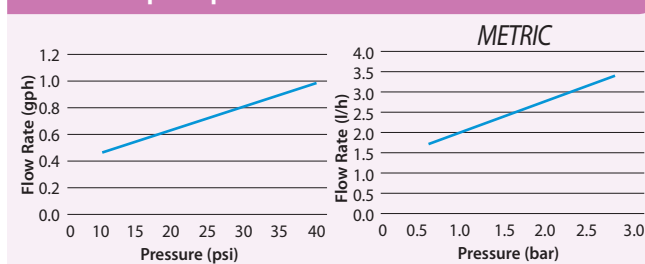

Maximum Length of Run (Feet)

Emitter Spacing	Maximum Length of Run	Flow per Ft. @ 15 psi
6"	19 feet	1 gph/ft.
12"	33 feet	0.5 gph/ft.

1/4" Barb Transfer Fittings

Features

- Used to connect 1/4" Distribution Tubing (XQ) in different configurations or attach 1/4" tubing to 1/2" or 3/4" tubing
- Newly designed connectors have self-piercing barbs that easily puncture 1/2" or 3/4" tubing
- Stem on fittings allows simple, quick installation using Xeriman™ Tool (XM-TOOL)
- Rugged plastic construction

Operating Range*

- Pressure: 0 to 50 psi (0 to 3.5 bar)
**with polyethylene tubing*

Models

- XBF1CONN: 1/4" barb connector
- XBF2EL: 1/4" barb x barb elbow
- XBF3TEE: 1/4" barb x barb x barb tee



XBF1CONN

XBF2EL

XBF3TEE

Subterranean Emitter Box

Features

- Provides convenient access to subsurface emitter while protecting against vandalism. Ideal for multi-outlet devices (such as Xeri-Bird 8) and Air Vacuum Relief Valve Kit
- New larger body allows more room for components and distribution tubing
- Rugged, UV-resistant thermoplastic construction
- Available with black top

Dimensions

- Height: 9.0" (22.9 cm)
- Top Diameter: 6.4" (16.3 cm)
- Base Diameter: 9.8" (24.9 cm)

Model

- SEB 7XB



SEB 7XB

Galvanized Tie-Down Stake

9-gauge galvanized steel stake to secure distribution tubing, XF Dripline or XBS Tubing to finished grade

Features

- **Durability:** Sturdy 9 gauge galvanized steel provides long-lasting and corrosion resistant hold strength for distribution tubing
- **Easy installation:** Sharp tips provide easy insertion into all soil types
- **Convenience:** robust packaging options provide ease of transportation and storage

Specifications:

- Size: 6 inches
- Material: galvanized steel
- Thickness: 9 gauge

Models

- TDS-6050: 6 in. galvanized tie down stake (50 piece)
- TDS-6500: 6 in. galvanized tie down stake (500 pieces, pail)



TDS-6050

TDS-6500

Tubing Goof Plug

Features

- Used to plug unwanted holes in tubing
- New design works with Xeriman™ Tool (XM-TOOL) for a quick, easy installation

Model

- EMA-GPX



EMA-GPX

Tubing Cutter

Features

- Re-designed Xerigation® Tubing Cutter allows for easier and cleaner cuts of all low-volume tubing
- Unique design provides two different-sized wells (one for 1/2" - 3/4" tubing and one for 1/4" tubing; giving more leverage so less force is needed to cut any tubing)
- Tubing Cutter is lightweight with stainless steel blades. Replacement blades available (PPC-200XBLD)

Models

- PPC-200X: Tubing cutter
- PPC-200XBLD: Replacement blades



PPC-200X

Improved Dual-well
Design Allows for
Clean Cuts

Control Zone Kit Selection Guide



XCZ-150-LCS
FLOW: 15 - 62 gpm



XCZ-150-LCDR
FLOW: 15 - 62 gpm

Commercial High Flow: 15 - 62 gpm

Pages
155 - 152



XCZ-100-FLOW
FLOW: 0.3 - 20 gpm



XCZ-100-PRB-COM
FLOW: 0.3 - 20 gpm



XCZ-100-PRBR
FLOW: 0.3 - 20 gpm



XCZ-100-PRB-LC
FLOW: 0.3 - 20 gpm

Commercial Wide Flow: 0.3 - 20 gpm

Pages
157 - 158



XCZPGA-100-PRF
FLOW: 3 - 15 gpm



XCZ-100-PRF
FLOW: 3 - 15 gpm



XACZ-100-PRF
FLOW: 3 - 15 gpm

Residential Medium Flow: 3 - 15 gpm

Pages
155 - 156



XCZLF-100-PRF
FLOW: 0.2 - 10 gpm



XCZ-075-PRF
FLOW: 0.2 - 5 gpm



XACZ-075-PRF
FLOW: 0.2 - 5 gpm

Residential Low Flow: Flow: 0.2 - 10 gpm

Residential Low Flow: Flow: 0.2 - 5 gpm

Pages
154 - 155

Online Control Zone Kit Selection Guide

Rain Bird Control Zone Kits provide all of the components necessary for on/off control, filtration and pressure regulation of a low-volume irrigation zone, making the kits simple to order and easy to install.

This quick selection tool will help you find the appropriate control zone kit for your application. By answering a few simple questions, the selection guide will provide recommended control zone kits best suited for your application. Simply click on the kit image for detailed information and specifications.

Features

- Includes detailed drawings and specifications for each kit
- Available at www.rainbird.com/CZK



Control Zone Kits

Rain Bird Control Zone Kits provide all of the components necessary for on/off control, filtration, and pressure regulation in a single package, making them simple to order and easy to install.

- Most reliable kits, and contain revolutionary products such as the Low Flow Valve and Quick Check Basket Filter
- All kits in every category use the innovative PR Filter which combines the filter and pressure regulator into one unit.

- Rain Bird offers the most complete line of Control Zone Kits, giving contractors and specifiers the flexibility to meet every need from 0.2 to 40 gpm. Choose from:
 - ¾", 1" or 1½" inlet opening
 - Low Flow Valve, Anti-Siphon Valve, DV Valve, or PESB Valve
 - Pressure Regulating RBY Filters, Pressure Regulating Quick Check Basket Filter, Quick Check Basket Filter or Quick Check Basket Filter with Flow Indicator

Use the chart below to identify the most appropriate kit or see pages 154 - 166 for specific detailed information on these kits and their individual components. Also available is the interactive Control Zone Kit Pyramid Selection Guide for selection and detailed specification information; found at www.rainbird.com/professionals/products/drip-control

Control Zone Selection Chart									
Model	Flow Rate	Flow rate capability (.9 gph dripline with 12" emitter spacing)	Valve Type	2-Wire Compatible	Filtration Type	Pressure Regulator	Inlet/Outlet Size	Size	Minimal Valve Box Size
Commercial Control Zone Kits									
XCZ-150-LCS	15-62 GPM	1000 to 4000 feet of dripline	150-PEB	Yes	120 Mesh Disc Filter (130 Micron)	40 psi	1.5" x 1.5"	20.5" Length	Jumbo Rectangular
XCZ-100-FLOW	0.3-20 GPM	20 to 1300 feet of dripline	100-PESB		150 Mesh Disc Filter (100 Micron)		1" x 1"	14" Length	Mini- Standard Rectangular
XCZ-100-PRB-COM			100-PEB		200 Mesh Stainless Steel (75 Micron)		12" Length		
XCZ-100-PRB-LC									
Commercial Control Zone Kits for Reclaimed Water									
XCZ-150-LCDR	15-62 GPM	1000 to 4000 feet of dripline	150-PESBR	Yes	120 Mesh Disc Filter (130 Micron)	40 psi	1.5" x 1.5"	23.5" Length	Jumbo Rectangular
XCZ-100-PRBR	0.3-20 GPM	20 to 1300 feet of dripline	100-PESBR	Yes	200 Mesh Stainless Steel (75 Micron)		1" x 1"	10.5" Length	Mini- Standard Rectangular
Residential Control Zone Kits									
XCZPGA-100-PRF	3-15 GPM	200 to 1000 feet of dripline	100-PGA	Yes	200 Mesh Stainless Steel (75 Micron)	40 psi	1" x 1"	11" Length	Mini- Standard or 10" Round
XCZ-100-PRF			100-DV	No				10" Length	
XCZLF-100-PRF	0.2-10 GPM	LFV-100							
XCZ-075-PRF	0.2-5 GPM	LFV-075							
Residential Control Zone Kits with Anti-Siphon									
XACZ-100-PRF	3-15 GPM	200 to 1000 feet of dripline	100-ASV	No	200 Mesh Stainless Steel (75 Micron)	40 psi	1" x 1"	14" Height	—
XACZ-075-PRF	0.2-5 GPM	13 to 300 feet of dripline	ASV-LFV-075			30 psi	¾" x ¾"		



Combine a Xerigation® Control Zone Kit with a Rain Bird controller product to precisely regulate zone watering times.

Low Flow Control Zone Kits with PR Filter

- Reliable Control Zone Kits that include the Low Flow Valve, the only valve on the market that can handle low flows (below 3 gpm) without weeping
- Shorter kits with only two components (valve plus pressure-regulating filter) mean that you can fit more Control Zone Kits in a valve box, saving time and money
- These PR Filter kits provide on/off control, filtration, and pressure regulation with fewer components; so there is less chance of leakage at the connections, both at installation and over the life of the system

Operating Range

- Flow: 0.20 to 10 gpm (0.8 to 37.85 l/m)
- Inlet pressure: 20 to 150 psi (1.4 to 10.3 bar)
- Regulated pressure: 30 psi (2.1 bar)
- Filtration: 200 mesh stainless steel screen (75 micron)

Models

- XCZ-075-PRF: ¾" Low Flow Valve with ¾" PR RBY Filter (Assembled)
- Flow: 0.2 to 5.0 gpm (0.8 to 18.91 l/m)
- XCZLF-100-PRF: 1" Low Flow Valve with 1" PR RBY Filter (Assembled)
- Flow: 0.2 to 10.0 gpm (0.8 to 37.85 l/m)

Replacement Screen

- RBY-200SSMX (200 mesh stainless steel screen)

Minimum Inlet Pressure for 30psi (2.1 bar) outlet pressure			
XCZ-075-PRF			
Flow (gpm)	Flow (l/m)	Pressure (psi)	Pressure (bar)
0.2	0.8	34.4	2.4
1.0	3.8	36.1	2.5
3.0	11.4	38.1	2.6
5.0	18.9	43.4	3.0

Minimum Inlet Pressure for 40psi (2.8 bar) outlet pressure			
XCZLF-100-PRF			
Flow (gpm)	Flow (l/m)	Pressure (psi)	Pressure (bar)
0.2	0.8	44.4	3.1
1.0	3.8	44.4	3.1
3.0	11.4	45.0	3.1
5.0	18.9	46.2	3.2
10.0	37.9	52.2	3.6



Four Control Zone Kits in a Standard Valve Box



Low Flow Control Zone Kits with Anti-Siphon Valve and PR Filter

- Reliable Control Zone Kits that include the Low Flow Valve, the only valve on the market that can handle low flows (below 3 gpm) without weeping
- Complete, two-piece Control Zone Kits include the field-proven Low Flow Anti-Siphon Valve that has an atmospheric vacuum breaker for backflow prevention and an IAPMO rating
- These PR Filter kits provide on/off control, filtration, and pressure regulation with only two parts; so there is less chance of leakage at the connections, both at installation and over the life of the system

Operating Range

- Flow: 0.20 to 5.0 gpm (0.8 to 18.9 l/m)
- Inlet pressure: 20 to 150 psi (1.4 to 10.3 bar)
- Filtration: 200 mesh stainless steel screen (75 micron)
- Regulated pressure: 30 psi (2.1 bar)

Models

- XACZ-075-PRF: 3/4" Low Flow Anti-Siphon Valve with 3/4" PR RBY Filter

Replacement Screen

- RBY-200SSMX (200 mesh stainless steel screen)



XACZ-075-PRF

Medium Flow Control Zone Kits with Anti-Siphon Valve and PR Filter

- Complete, two-piece Control Zone Kits include the field-proven ASVF valve which has an atmospheric vacuum breaker for backflow prevention and an IAPMO rating
- These PR Filter kits provide on/off control, filtration, and pressure regulation with only two parts; so there is less chance of leakage at the connections, both at installation and over the life of the system

Operating Range

- Flow: 3.0 to 15.0 gpm (11.4 to 56.8 l/m)
- Inlet pressure: 20 to 150 psi (1.4 to 10.3 bar)
- Filtration: 200 mesh stainless steel screen (75 micron)
- Regulated pressure: 40 psi (2.8 bar)

Models

- XACZ-100-PRF: 1" ASVF with 1" PR RBY Filter

Replacement Screen

- RBY-200SSMX (200 mesh stainless steel screen)



XACZ-100-PRF

Minimum Inlet Pressure for 30psi (2.1 bar) outlet pressure

Flow gpm	l/m	Inlet Pressure	
		psi	bar
0.2	0.8	37.4	2.6
1.0	3.8	39.1	2.7
3.0	11.4	40.0	2.8
5.0	18.9	49.7	3.4

XACZ-075-PRF

Minimum Inlet Pressure for 40 psi Outlet Pressure

Flow gpm	l/m	Inlet Pressure	
		psi	bar
3.0	11.4	43.3	3.0
5.0	18.9	44.7	3.1
7.0	26.5	46.2	3.2
9.0	34.1	47.3	3.3
11.0	41.6	50.8	3.5
13.0	49.2	55.4	3.8
15.0	56.8	59.7	4.1

XACZ-100-PRF

Medium Flow Control Zone Kits with PR Filter

- Reliable Control Zone Kit that includes an extra durable PGA valve
- These PR Filter kits provide on/off control, filtration, and pressure regulation with only two parts; so there is less chance of leakage at the connections, both at installation and over the life of the system
- 2-wire compatible residential Control Zone Kit

Operating Range

- Flow: 3 to 15 gpm (11.4 to 56.8 l/m)
- Inlet pressure: 20 to 150 psi (1.4 to 10.3 bar)
- Filtration: 200 mesh stainless steel screen (75 micron)
- Regulated pressure: 40 psi (2.8 bar)

Models

- XCZPGA-100-PRF: 1" PGA Valve with 1" PR Filter

Replacement Screen

- RBY-200SSMX (200 mesh stainless steel screen)



XCZPGA-100-PRF

Medium Flow Control Zone Kits with PR Filter

- Shorter kits with only two components (valve plus pressure-regulating filter) mean that you can fit more Control Zone Kits in a valve box, saving time and money
- These PR Filter kits provide on/off control, filtration, and pressure regulation with only two parts; so there is less chance of leakage at the connections, both at installation and over the life of the system

Operating Range

- Flow: 3 to 15 gpm (11.4 to 56.8 l/m)
- Inlet pressure: 20 to 150 psi (1.4 to 10.3 bar)
- Filtration: 200 mesh stainless steel screen (75 micron)
- Regulated pressure: 40 psi (2.8 bar)

Models

- XCZ-100-PRF: 1" DV Valve with 1" PR Filter (Assembled)*

* Available with BSP threads

Replacement Screen

- RBY-200SSMX (200 mesh stainless steel screen)



XCZ-100-PRF

Minimum Inlet Pressure for 40 psi outlet pressure

Flow gpm	Inlet Pressure (psi) XCZPGA-100-PRF	Inlet Pressure (psi) XCZ-100-PRF
3.0	45.8	42.9
5.0	47.0	44.1
10.0	50.7	48.5
15.0	57.6	55.5

Minimum Inlet Pressure for 2.8 bar outlet pressure

Flow l/m	Inlet Pressure (bar) XCZPGA-100-PRF	Inlet Pressure (bar) XCZ-100-PRF
11.4	3.2	3.0
18.9	3.2	3.0
37.9	3.5	3.3
56.8	4.0	3.8

Wide Flow Commercial Control Zone Kit with Pressure Regulating, Basket Filter

- Industry wide flow range between 0.3 and 20 gpm (1.13 to 75.71 l/m) leading enables single SKU purchase for large projects
- Updated with the reliable, flexible and proven PEB valve with the rugged pressure regulating basket filter
- This PR Filter kit provides on/off control, filtration, and pressure regulation with only two parts; so there is less chance of leakage at the connections, both at installation and over the life of the system
- The “No Spill” feature of the basket filter ensures dirt does not fall back into the filter during cleanup operation. The threaded filter top with O-ring makes it easy to remove and clean that stainless steel filter screen

Operating Range

- Flow: 0.3 to 20 gpm (1.13 to 75.71 l/m)*
- Inlet Pressure: 15 to 150 psi (1,0 to 10,3 bar)
- Regulating Pressure: 40 psi (2,7 bar)
- Filtration: 200 mesh (75 micron) stainless steel
- Temperature: Up to 150 degree F (66 degree C)

Model

- X CZ-100-PRB-LC: 1" PEB Valve with 1" Pressure Regulating (40 psi), Basket Filter

Replacement Filter Screens

- QKCHK-100M: 100 mesh stainless steel screen, red
- QKCHK-200M: 200 mesh stainless steel screen, white

Replacement Cap

- BFCAP (Complete cap with body o-ring)

**For flows below 5gpm Rain Bird recommends use of upstream filtration to prevent debris from collecting below the diaphragm*

Minimum Inlet Pressure for 40 psi (2.8 bar) Outlet Pressure

Flow Rate gpm	l/m	Inlet Pressure	
		psi	bar
0.3	1.14	41.0	2.82
1.0	3.78	41.5	2.86
5.0	18.9	43.0	2.9
10.0	37.9	48.0	3.3
15.0	56.8	56.0	3.8
20.0	75.7	65.0	4.5



X CZ-100-PRB-LC

Wide Flow Commercial Control Zone Kit with Scrubber Valve & Pressure Regulating, Basket Filter

- Complete kit is the simplest, smallest and most reliable Control Zone Kit for commercial applications between 0.3 and 20 gpm (1.13 and 76 l/m)
- Includes the reliable, proven PESB Valve which provides patented scrubbing action, making this kit ideal for commercial dirty water applications
- Includes the Pressure Regulating, Quick-Check Basket Filter that has a clear indicator which goes from green to red, telling you when to clean the filter. This reduces maintenance and takes the guesswork out of cleaning the filter. In addition, the threaded top makes it easy to remove and clean the stainless steel screen
- Basket Filter and Pressure Regulator have been combined for one smaller Pressure Regulating, Quick-Check Basket filter that is 24% smaller than the previous unit
- Flow Indicating Basket Filter kit provides flow measurement, filtration (stainless steel, 150 mesh) and 40 psi integrated pressure regulation all in an all-in-one compact kit that protects your irrigation system

Operating Range

- Flow: 0.3 to 20.0 gpm (1.13 to 75.7 l/m)*
- Inlet Pressure: 15 to 150 psi (1,0 to 10,3 bar)
- Regulating Pressure: 40 psi (2,7 bar)
- Filtration: 200 mesh (75 micron) stainless steel
- Temperature: Up to 150° F (66° C)

Model

- XCZ-100-FLOW: 1" Ball Valve with 1" PESB valve and 1" Pressure Regulating (40 psi) Quick Check Basket Filter with Flow Indication
- XCZ-100-PRB-COM: 1" Ball Valve with 1" PESB Valve and 1" Pressure Regulating (40 psi), Quick-Check Basket Filter
- XCZ-100-PRBR: 1" PESBR Valve and 1" Pressure Regulating (40psi) Basket Filter

Replacement Screens

Replacement Screens for XCZ-100PRBR & XCZ-PRB-COM

- QKCHK100M (100 mesh/150 micron stainless steel screen)
- QKCHK200M (200 mesh/75 micron stainless steel screen)

Replacement Screens for XCZ-100-FLOW

- FLOW120M (120 mesh/125 micron stainless steel screen)
- FLOW150M (150 mesh/100 micron stainless steel screen)
- FLOW200M (200 mesh/75 micron stainless steel screen)

Replacement Cap

- QKCHKCAP (Complete cap with body o-ring)

*For flows below 5gpm Rain Bird recommends use of upstream filtration to prevent debris from collecting below the diaphragm

Minimum Inlet Pressure for 40 psi outlet pressure		
Flow gpm	Inlet Pressure (psi) XCZ-100-PRB-COM	Inlet Pressure (psi) XCZ-100-PRBR
0.3	41.0	41.0
1.0	41.5	41.5
3.0	42.0	42.0
5.0	44.0	45.0
10.0	47.3	49.0
15.0	53.0	57.0
20.0	62.5	62.5

Minimum Inlet Pressure for 2.8 bar Outlet Pressure		
Flow l/m	Inlet Pressure (bar) XCZ-100-PRB-COM	Inlet Pressure (bar) XCZ-100-PRBR
1.136	2.82	2.82
3.78	2.86	2.86
11.4	2.9	2.9
18.9	3.0	3.1
37.9	3.3	3.4
56.8	3.6	3.9
75.7	4.3	4.3



1.5" Inline Commercial Control Zone Kit

Run Up to 62 gpm for Large Zones

- High Flow Range: Allows for larger drip zone coverage with one control zone kit, saving labor cost, material cost and installation hassle.
- Low Friction Loss: Allows usage in zones with lower head pressure.
- Fully Assembled: Saves installation labor cost by ensuring all key components are included and that the direction of flow in individual components is assembled properly.
- Inline Configuration: Fewer connection points, which fits two kits instead of just one in a jumbo valve box. Also provides more access for maintenance and components.

Operating Range

- Flow Range: 15 to 62 gpm (56.8 l/min to 234.69 l/min)
- Inlet Pressure: 15 to 115 psi (1.03 to 7.9 bar)
- Regulated Pressure: 40 psi (2.8 bar)
- Filtration: 120 mesh (130 micron)
- Water Temperature: 33° F up to 110° F (0.5° C to 43° C)
- Ambient Temperature: 33° F up to 125° F (0.5° C to 52° C)

Specifications

Dimensions

- XCZ-150-LCS: 20 3/4" L x 5 3/4" W x 9 1/2" H
- XCZ-150-LCDR: 23 1/2" L x 5 3/4" W x 9 1/2" H

Filtration

- XCZ-150-LCS: 1 1/2" (3.81 cm) Stainless Steel Screen Filter, 120 Mesh (130 Micron); Surface Area: 42 in² (270 cm²)
- XCZ-150-LCDR: 1 1/2" (3.81 cm) Disc Filter, 120 Mesh (130 Micron); Surface Area: 48 in² (310 cm²)

Valve Type

- XCZ-150-LCS: 1.5" PEB
- XCZ-150-LCDR: 1.5" PESB-R
- Power: 24 VAC 50/60 Hz (cycles/sec) solenoid
- Inrush Current: 0.41A (9.84 VA) at 50/60Hz
- Holding Current: 0.14A (3.43VA) at 50/60Hz
- Coil Resistance: 30-39 Ohms
- Two-wire compatible with ESP-LXD Decoders

Models

- XCZ-150-LCS
- XCZ-150-LCDR

Replacement Filters

Disc

- LGFC120MD

Screen

- LGFC120MS

Pressure Loss Characteristics

Flow Rate (gpm)	XCZ-150-LCS	XCZ-150-LCDR
15	1.9	2.3
20	2.4	3.4
25	4.1	4.9
30	5.3	5.3
40	7.4	8.0
50	13.6	14.4
60	20.7	20.7

Pressure Loss Characteristics

Flow Rate (l/h)	XCZ-150-LCS	XCZ-150-LCDR
56.8	0.13	0.16
75.7	0.17	0.23
94.7	0.28	0.34
113.6	0.37	0.37
151.4	0.51	0.55
189.3	0.94	0.99
227.1	1.43	1.43



XCZ-150-LCS



XCZ-150-LCDR

Low Flow Valves

Valves designed exclusively for the low flow rates of a drip irrigation system (0.2 - 10.0 gpm; 0.6 to 37.8 l/m)

Features

- The only valves in the industry made specifically for drip irrigation systems, making these the only valves that can effectively handle particles at low flow rates – patented design
- These valves contain all of the features of reliable Rain Bird DV valves, coupled with a unique diaphragm design that allows particles to pass through at extremely low flow rates, thereby preventing weeping of the valve
- Allows the filter to be safely placed downstream of the valve since these valves handle all sizes of particles
- Unique “double-knife” diaphragm coupled with ½" diameter seat for flawless operation at low flow rates
- Low Flow Valve is available in ¾" In-line model
- Double-filtered pilot flow design for maximum reliability
- External bleed to manually flush the system of dirt and debris during installation and system start-up
- Internal bleed for spray-free manual operation.

Operating Range

- Flow: 0.20 to 10.0 gpm (0.6 to 37.8 l/m)
- Pressure: 15 to 150 psi (1.0 to 10.3 bar)

Electrical Specifications

- 24 VAC 50/60 Hz (cycles/sec) solenoid
- Inrush current: 0.30 (7.2 VA) at 50/60 Hz
- Holding current: 0.19 A (4.56 VA) at 50/60 Hz

Models

- LFV-075: ¾" Low Flow DV Valve
- LFV-100*: 1" Low Flow DV Valve

*Available with BSP threads

Pressure Loss Characteristics		
Flow gpm	LFV-075 psi	LFV-100 psi
0.2	3.0	3.0
1.0	3.2	3.4
2.0	3.3	3.8
4.0	3.6	5.0
6.0	4.2	6.4
8.0	6.8	7.5

Pressure Loss Characteristics		METRIC
Flow l/m	LFV-075 bar	LFV-100 bar
0.6	0.21	0.21
3.6	0.22	0.23
7.8	0.23	0.26
15.0	0.25	0.34
22.8	0.28	0.44
30.0	0.47	0.52

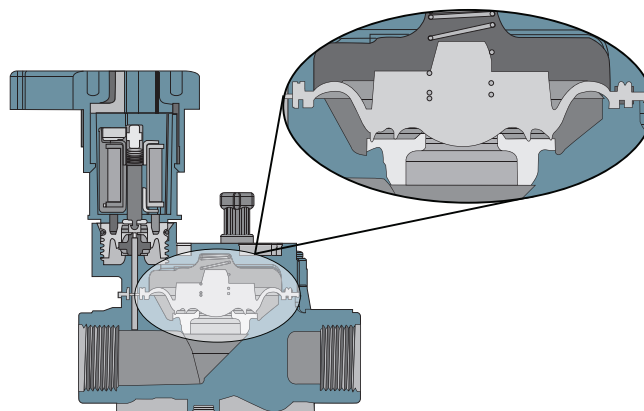

Unique Diaphragm Design



LFV-075

Note: Also available as part of XCZLF-100-PRF (p. 154)

Inline RBV Filter

Static filter helps prevent plugging in a drip irrigation system

Features

- A simple and reliable filter for low-volume irrigation systems
- Simple to clean, as cap has a sealing O-ring and unthreads to provide access to the stainless steel filter element
- Strong and reliable due to its robust design and glass-filled polypropylene construction
- Male x Male threaded connections for direct connection to valves and pressure regulators
- Replacement stainless steel elements are available in 200 mesh (75 micron)

Operating Range

- Flow:
 - 3/4" units: 0.20 to 12.0 gpm (0.8 to 45.4 l/m)
 - 1" units: 0.20 to 18.0 gpm (0.8 to 68.1 l/m)
- Pressure: 20 to 150 psi (1.4 to 10.3 bar)
- Filtration: 200 mesh (75 micron)

Models

- RBY075MPTX: 3/4" Inline RBV Filter with 200 Mesh Screen
- RBY100MPTX: 1" Inline RBV Filter with 200 Mesh Screen*

Replacement screen:

- RBY-200SSMX (200 mesh stainless steel screen)

Note: Filter must be installed downstream of a control valve and not under constant pressure.



RBY075MPTX

Pressure Loss Characteristics					
Flow Rate		RBY075MPTX		RBY100MPTX	
gpm	l/m	psi	bar	psi	bar
1.00	0.8	0.1	0.00	0.1	0.00
3.00	3.8	0.4	0.01	0.3	0.01
5.0	11.4	1.1	0.03	0.5	0.02
7.0	18.9	1.6	0.08	0.8	0.03
9.0	26.5	2.7	0.11	1.4	0.06
12.0	34.1	4.5	0.19	2.2	0.10
14.0	45.4	—	0.31	3.0	0.15
16.0	53.0	—	—	3.8	0.21
18.0	60.6	—	—	4.7	0.26
	68.1	—	—	—	0.32

Note: Pressure loss for 200 mesh filter screen

Pressure-Regulating Filter (RBY)

Unique, compact unit that works with all valves to create a simple, efficient control zone. Combines filtration and pressure regulation in one piece for protection of downstream components in a low-volume irrigation system

Features

- Reduces the number of components in a control zone, making it smaller and easier to install. More control zones can fit in one valve box!
- Combination unit comes with 200 mesh (75 micron) stainless steel reduces the number of connections, making installation easier and faster
- Static RBY filter regulates pressure to a nominal 30 or 40 psi (2.0 or 2.8 bar) - PR RBY Filter Cap has sealing O-ring and unthreads to provide access to the filter element for easy cleaning
- 30 or 40 psi pressure regulator is integrated into the filter body
- Robust body and cap are made of glass-filled polypropylene and provide 150 psi (10.3 bar) pressure rating

Operating Range

- Flow - 3/4" units: 0.20 to 5.0 gpm (0.8 to 18.9 l/m)
 - 1" units: 3.0 to 15.0 gpm (11.4 to 56.8 l/m)
- Inlet pressure: 20 to 150 psi (1.4 to 10.3 bar)
- Regulated pressure: - 3/4" units: 30 psi (2.1 bar)
 - 1" units: 40 psi (2.8 bar)

Models

- PRF-075-RBY: 3/4" PR RBY Filter
- PRF-100-RBY: 1" PR RBY Filter

Replacement Screen

- RBY-200SSMX (200 mesh stainless steel screen)

Note: When installing with emission points more than 5 ft. above the pressure regulating filter, a check valve should be installed after the regulator.

Note: Filter must be installed downstream of a control valve and not under constant pressure.



PRF-075-RBY and PRF-100-RBY

Pressure Loss Characteristics					
Flow Rate		PRF-075-RBY		PRF-100-RBY	
gpm	l/m	psi	bar	psi	bar
0.2	0.8	3.0	0.21	N/A	N/A
1.0	3.8	4.0	0.28	N/A	N/A
3.0	11.4	6.1	0.42	0.8	0.06
5.0	18.9	10.0	0.69	2.0	0.14
8.0	30.3	N/A	N/A	3.8	0.26
10.0	37.9	N/A	N/A	5.2	0.36
15.0	56.8	N/A	N/A	12.0	0.83

Note: Pressure loss for 200 mesh filter screen

Components of Control Zone Kits Found on pg. 154-166

Stainless Steel Screen

Drip Irrigation



Quick-Check Basket Filter

The only commercial-grade filter with a clean/dirty indicator for low-volume irrigation zones

Features

- Reduces maintenance and labor costs — the indicator tells you when to clean the filter, taking the guesswork out of cleaning the filter
- Provides increased reliability – “No-spill” feature ensures dirt does not fall back into the filter during cleanup operation
- Simplifies installation and maintenance - threaded top with O-ring makes it easy to remove and clean the screen
- Available in 1" model
- Comes pre-assembled with 200 mesh (75 micron) stainless steel screen (other screen sizes available)

Operating Range

- Flow: 0.3 to 20.0 gpm (11.4 to 75.7 l/m)
- Pressure: 0-150 psi (0 to 10.3 bar)

Models

- QKCHK-100*: 1" Basket Filter with 200 mesh stainless steel screen
* Available with BSP threads

Pressure Loss Characteristics - QKCHK-100

Flow Rate gpm	l/m	100 mesh screen		200 mesh screen	
		psi	bar	psi	bar
3	11.4	0.1	0.0	0.0	0.0
5	18.9	0.2	0.0	0.0	0.0
7	26.5	0.4	0.0	0.4	0.0
9	34.1	0.7	0.0	0.7	0.0
11	41.6	0.9	0.1	1.1	0.1
14	53.0	1.3	0.1	1.6	0.1
20	75.7	2.9	0.2	3.2	0.2

Note: Pressure loss for 200 mesh filter screen

Replacement Filter Screens

- QKCHK-100M: 100 mesh screen, red
- QKCHK-200M: 200 mesh stainless steel screen, white

Replacement Cap

- QKCHKCAP (Complete cap with body o-ring)



QKCHK-100

Retrofit Pressure Regulators

Features

- Provides convenient 30 psi (2.1 bar) pressure regulation at the riser for any ½" FPT emission device or compression adapter
- Can be installed above or below grade
- Can be used with Xeri-bird™ 8 Multi-Outlet Emission Device (see page 121)

Operating Range

- Flow: 0.50 to 4.00 gpm; 30 to 240 gph (1.9 to 15.1 l/m)
- Inlet Pressure: 15 to 70 psi (1.0 to 4.8 bar)

Dimensions

- ½" female-threaded inlet
- Height: 4" (10 cm)

Model

- PRS-050-30



PRS-050-30

Pressure Regulating, and Quick-Check Pressure Regulating Basket Filters

The only commercial-grade filter with built in pressure regulator for low-volume irrigation zones. Also available with a clean/dirty indicator.

Features

- Reduces maintenance and labor costs - 40% larger filter surface than standard filters means less frequent cleaning
- Provides increased reliability – “No Spill” feature ensures dirt does not fall back into the filter during cleanup operation
- Simplifies installation and maintenance – threaded top with O-ring makes it easy to remove and clean that stainless steel filter screen
- Efficient design – combines filtration and pressure regulation in one compact unit with fewer connections
- Available in 1" model
- Comes pre-assembled with 200 mesh (75 micron) stainless steel screen (other screen sizes available)
- Built-in 40 psi (2,7 bar) pressure regulator
- Also available in Light Commercial Control Zone Kits:
 - XCZ-100-PRBR (without Quick-Check feature)
 - XCZ-100-PRB-LC (without Quick-Check feature)
 - XCZ-PRB-100-COM (with Quick-Check)
 - XCZ-PRB-150-COM (with Quick-Check)

Operating Range

- Flow: 0.3 to 20 gpm (18.9 to 75.7 l/m)
- Inlet Pressure: 15 to 150 psi (1,0 to 10,3 bar)
- Regulating Pressure: 40 psi (2,7 bar)
- Filtration: 200 mesh (75 micron) stainless steel
- Temperature: Up to 150 degree F (66 degree C)

Components
of Control Zone
Kits Found on
pg. 154-166

Models

- PRB-100: 1" Basket Filter with built-in Pressure Regulator (40 psi) and 200 mesh (75 micron) stainless steel screen
- PRB-QKCHK-100: 1" Basket Filter with built-in Pressure Regulator (40 psi) and 200 mesh (75 micron) stainless steel screen

Replacement Filter Screens

- QKCHK-100M: 100 mesh stainless steel screen, red
- QKCHK-200M: 200 mesh stainless steel screen, white

Replacement Cap

- QKCHKCAP (Complete cap with body o-ring)

Note: When installing with the emission points more than 5 feet above the pressure regulating filter, a check valve should be installed after the regulator.

Minimum Inlet Pressure for 40 psi (2.8 bar) Outlet Pressure

Flow Rate gpm	l/m	Inlet Pressure PRB-100 / PRB-QKCHK-100		Inlet Pressure PRB-QKCHK-200	
		psi	bar	psi	bar
3	11.4	41	2.8	43	2.9
5	18.9	42	2.9	48	3.3
10	37.9	48	3.3	52	3.6
15	56.8	52	3.6	54	3.7
20	75.7	64	4.4	66	4.5



PRB-100

Stainless
Steel
Screen



PRB-QKCHK-100



QKCHK-200M

1" & 1½" High Flow Inline Pressure Regulators

NEW

High flow Pressure Regulator family that delivers pre-set regulation for a wide flow range (0.5 -70 gpm) providing a solution for most irrigation applications.

Features

Flexibility

- Its high flow range (0.5 gpm to 70 gpm) capacity allows usage in a wide range of applications, making it ideal for drip or spray applications. It can be installed above or below grade.
 - 1" Pressure Regulators flow range: 0.5-35 gpm (1.9 to 132.5 l/min)
 - 1½" Pressure Regulator flow range: 15-70 gpm (56.8 to 265.0 l/min)

Reliable Performance:

- Pre-set outlet pressure regulation at either 40 psi (2.8 bar) or 50 psi (3.4 bar) provides worry-free protection for your irrigation installations.

Durability:

- Tested to meet Rain Bird's high-quality standards. High Strength ABS construction and stainless steel springs provide the durability to withstand any job.

Operating Range

- Pressure Regulation:
 - PSI-H40X-100: 40 psi (2.8 bar)
 - PSI-H50X-100: 50 psi (3.4 bar)
 - PSI-H40X-150: 40 psi (2.8 bar)
 - PSI-M30X-075: 30 psi (2.1 bar)
- Flow Range:
 - PSI-H40X-100 & PSI-H50X-100: 0.5 gpm (1.9 l/min) to 35 gpm (132.5 l/min)
 - PSI-H40X-150: 15 gpm (56.8 l/min) to 70 gpm (265.0 l/min)
 - PSI-M30X-075: 2.0 to 10.0 gpm; 120 to 600 gph (7.8 to 37.9 l/m)
- Inlet pressure: 15 to 150 psi (10.3 bar)
- Inlet Pressure (PSI-M30X-075): 10 to 150 psi (0.7 to 10.3 bar)

Specifications

- PSI-H40X-100 & PSI-H50X-100 : 1" Female NPT X 1" Female NPT
- PSI-H40X-150: 1 ½" Female NPT X 1 ½" Female NPT
- PSI-M30X-075: ¾" NPT female-threaded inlet and outlet

Dimensions:

- PSI-H40X-100 & PSI-H50X-100: 5.8" (14.7 cm) in Length x 2.7" (6.8 cm) in Width
- PSI-H40X-150: 6.3" (16.0 cm) in Length x 3.3" (8.4 cm) in Width

Models

- PSI-H40X-100: 1" 40 psi inline Pressure Regulator
- PSI-H50X-100: 1" 50 psi inline Pressure Regulator
- PSI- H40X-150: 1½" 40 psi inline Pressure Regulator
- PSI-M30X-075: ¾" 30 psi (2.1 bar) regulator for medium flow



1" & 1½" High Flow Inline Pressure Regulators



PSI-M30X-075

How to Specify

PSI - H XX X - 100	
Model Pressure Regulator	Inlet/Outlet Size 075 = ¾ in (1.9 cm) 100 = 1 in (2.5 cm) 150 = 1½ in (3.8 cm)
	Pre-Set Pressure Regulation 40 = 40 psi (2.8 bar) 50 = 50 psi (3.5 bar)
Flow Range Capacity H = High Flow (up to 70 gpm; 265 l/m) M = Medium Flow (up to 10 gpm; 37.9 l/m)	

Large-Capacity Filters

Large-Capacity high flow and low maintenance with a solid build

Features

- Provides extra large filtration capacity for residential, commercial, and municipal applications
- Durable filters can be easily removed for cleaning, significantly reducing cleaning time
- Disc filters can decompress for easy cleaning
- Auxiliary connection with a threaded cap can be drilled to allow draining or depressurization

Operating Range

- 1" Model: Maximum flow: Up to 26 gpm (6 m³/hr)
 - Filtering surface (disc): 28 in² (180cm²)
- 1.5" Models: Maximum flow: Up to 62 gpm (14 m³/hr)
 - Filtering surface (disc): 48 in² (310 cm²)
 - Filtering surface (screen): 42 in² (270 cm²)
- 2" Models: Maximum flow: Up to 110 gpm (25 m³/hr)
 - Filtering surface (disc): 81 in² (525 cm²)
 - Filtering surface (screen): 75 in² (485 cm²)
- Maximum Pressure: 116 psi (8 bar)
- Maximum Temperature: Up to 140° F (60° C)

Models

- LCRBY100D - 1" Large-Capacity Disc Filter
- LCRBY150S - 1.5" Large-Capacity Screen Filter
- LCRBY150D - 1.5" Large-Capacity Disc Filter
- LCRBY200S - 2" Large-Capacity Screen Filter
- LCRBY200D - 2" Large-Capacity Disc Filter

Specifications

- Inlet / Outlet Size:
 - 1" Models: 1" NPT
 - 1.5" Models: 1.5" NPT
 - 2" Models: 2" NPT

Dimensions

- 1": (6.8" H x 7.5" W x 3.3" D)
- 1.5": (9.5" H x 10.3" W x 5.7" D)
- 2": (9.7" H x 10.6" W x 5.7" D)

Filtration

- Stainless Steel Screen Filter: 120 Mesh (130 Micron)*
- Plastic Filter Discs: 120 Mesh (130 Micron)

*Screen not available in 1" model

Replacement Filters

- | | |
|-------------|---------------|
| Disc | Screen |
| • LGFC120MD | • LGFC120MS |



LCRBY200D



Disc & Screen Filters

Pressure Loss Characteristics - Disc Filter

Flow Rate gpm	l/m	1" Filter		1.5" Filter		2" Filter	
		psi	bar	psi	bar	psi	bar
5	18.93	0.60	0.04	0.08	0.01	0.10	0.01
11	41.67	1.16	0.08	0.18	0.01	0.10	0.01
22	83.33	2.61	0.18	0.40	0.03	0.10	0.01
33	125.0	4.35	0.30	0.73	0.05	0.24	0.02
44	166.67	—	—	1.05	0.07	0.40	0.03
55	208.33	—	—	1.50	0.10	0.60	0.04
66	250.00	—	—	2.18	0.15	0.82	0.06
77	291.67	—	—	3.10	0.21	1.10	0.08
88	333.33	—	—	3.95	0.27	1.60	0.11
99	375.00	—	—	—	—	2.03	0.14
110	416.67	—	—	—	—	2.47	0.17

Pressure Loss Characteristics - Screen Filter

Flow Rate gpm	l/m	1" Filter		1.5" Filter		2" Filter	
		psi	bar	psi	bar	psi	bar
5	18.93	0.80	0.06	0.00	0.00	0.00	0.00
11	41.67	1.74	0.12	0.00	0.00	0.00	0.00
22	83.33	2.90	0.20	0.50	0.03	0.20	0.01
33	125.0	4.06	0.28	0.95	0.07	0.25	0.02
44	166.67	—	—	1.45	0.10	0.44	0.03
55	208.33	—	—	1.89	0.13	0.60	0.04
66	250.00	—	—	2.32	0.16	0.87	0.06
77	291.67	—	—	2.76	0.19	1.16	0.08
88	333.33	—	—	3.19	0.22	1.45	0.10
99	375.00	—	—	—	—	1.89	0.13
110	416.67	—	—	—	—	2.32	0.16

Note: Body dimensions are available on the Rain Bird website.

Note: Filter must be installed downstream of the valve, to prevent the filter from being under constant pressure.

Spray-to-Drip Retrofit Kit

Simple kit that easily converts a conventional spray zone to a low-volume irrigation zone

Features

- Permits convenient conversion to drip tubing when used with barbed adapter
- Provides 30 psi (2,0 Bars) pressure regulation and a 200-mesh (75 micron) screen that is easily accessible
- Supports flow rates of 0.5 to 6 gpm
- Internal assembly drops into 1804 spray head bodies to easily retrofit existing system to Xerigation® products
- Comes with 1 low profile Barb Tee and 1 Elbow Fitting
- Includes (1) ½" FPT x Elbow Fitting and (1) ½" FPT x Tee Fitting for easy connection to drip tubing

Operating Range

- Flow: 0.5 to 6 gpm (0.11 to 1.36 l/m)
- Inlet pressure: 15 to 70 psi (1.0 to 4.8 bar)
- Regulated pressure: 30 psi (2.1 bar)
- Filtration: 200 mesh (75 micron)

Model

- 1800-RETRO

Dimensions

- ½" (15/21) female-threaded inlet
- ½" (15/21) male-threaded swivel outlet
- Width:
 - Cap: 2.25" (5.70 cm)
 - Body: 1.5" (3.80cm)

Replacement Screen

- RBY-200SSMX (200 mesh stainless steel screen)



Model# 1800XC
Can be used to cap off unused Rain Bird 1800 Series spray bodies. (Sold separately)

Spray-to-Drip Conversion Steps



Designed specifically for areas with water restrictions, our Spray-to-Drip Retrofit Kit allows use of existing 1800 Series Spray Bodies as drip irrigation connection points.



- Introduction
- Spray Bodies
- Spray & Rotary Nozzles
- Rotors
- Valves
- Controllers
- Sensors & Meters
- Central Controls
- Drip Irrigation
- Pumps & Filtration**
- Drainage Products
- Resources



Pump Stations & Filtration



Water Saving Tips

- Newer high-efficiency motors are able to convert a higher percentage of their electric input to useful mechanical work resulting in energy and cost savings.
- Rain Bird Variable Frequency Drive (VFD) pump stations save energy while delivering the water pressure necessary to ensure maximum water use efficiency.
- Rain Bird designs pump stations specifically for the application, ensuring the pump runs at maximum efficiency. Delivering the right pressure as demanded by the system ensures your irrigation system is efficient and effective. For assistance call 520-806-5620 or email pumps@rainbird.com.

CLP Series

3 - 10hp; Up to 114 psi (7.9 bar); Up to 240 gpm (55 m³/hr)

Rain Bird's CLP Series pump station is designed for boost and flooded suction-lift applications. The CLP Series is a complete pump package that is simple to install and operate. It includes a professional-grade pump, a marine-grade aluminum enclosure, highest quality pump protection, and optional mounting for a Rain Bird controller. Home owner associations, small sports fields, schools, parks, and small agricultural projects are ideal applications. With this complete solution there is no need to deal with the hassle of stick building a pump station with non-compatible parts and a makeshift enclosure. Only Rain Bird provides a totally integrated irrigation solution with UL-listed components and a three-year warranty that dependably deliver healthy, beautiful landscapes, saving time and minimizing maintenance.

Features

- Plumbing Configurations
 - Inlet and discharge piping on opposite sides of the enclosure (as shown)
 - ¾" and 2" Priming Ports Included
- Mechanical Features
 - Isolation valve
 - Liquid filled pressure gauge
 - Rugged centrifugal pump (Suction Lift model is self-priming)

Enclosures / External Connections

- Marine grade aluminum enclosure and deck
- Stainless Steel piping
- Fused main power disconnect
- Pump Control Runs based on signal from irrigation controller, or from optional Flow Start Switch (Boost model only)
- 24VAC Pump start relay included. Other voltages available as an accessory
- 130 °F Temperature cutout switch



CLP Series
(Suction Lift shown)

At-A-Glance Description

- Variable Frequency Drive (VFD)
- Pump Start Relay included (24VAC/DC)
- Marine-Grade Aluminum Deck and Enclosure
- Powder-coated steel piping
- Isolation Valves for easy maintenance
- Manual Switch provides the user full control and override capabilities
- 3" Grooved Discharge, 3" Grooved Intake
- Available in single and three phase 208V, 220V, 230V, VAC and three phase 480V VAC configurations
- Mounting options for Rain Bird Controllers (purchased separately)

Options and Accessories

- Stainless steel piping to replace internal powder-coated steel piping (Contact Rain Bird Factory for availability)
- Pump Start Relay - 6VDC, 12VDC
- Controller Mounting Bracket: Controller can be mounted inside or outside of aluminum casing
- Surge Suppression Kit
 - Single Phase (208-230 VAC)
 - Three Phase (208-230 VAC or 480 VAC)Foot valve – 4" Vertical Flanged p/n CLPFTVLV4VF

CLP Series Pump Selection Chart | Please contact your Rain Bird Sales Representative for customization and ordering support

		Flow																															
Feet	PSI	30	35	40	45	50	55	60	65	70	75	80	85	90	95	100	105	110	115	120	125	130	135	140	150	160	170	180	190	200	210	PSI	Feet
270	110																															110	270
259	105																															105	259
247	100																															100	247
236	95																															95	236
224	90																															90	224
213	85																															85	213
201	80																															80	201
189	75																															75	189
178	70																															70	178
166	65																															65	166
155	60																															60	155
143	55																															55	143
132	50																															50	132
120	45																															45	120
109	40																															40	109
97	35																															35	97
85	30																															30	85
74	25																															25	74
62	20																															20	62
51	15																															15	51
39	10																															10	39

Low Profile Pump Stations – LP Series

Rain Bird's LP Series Horizontal End Suction and Vertical multistage pump stations are designed for small to midsize boost, flooded suction and suction lift applications such as city parks and buildings, sports fields, commercial buildings, small home owner's associations and large residential sites. Its low profile design, durable centrifugal or vertical multistage pump configuration, and choice of options make it an ideal choice for Turf irrigation applications.

Standard Features

- Cost effective – Standardized VFD driven pump system in enclosure delivers high performance with minimum investment
- Low Profile – Compact aluminum enclosure with powder coated skid and piping
- Energy efficient – Variable Frequency Drive (VFD) maintains constant pressure at varying flow demand
- Reliability – Simple, standard design, easy installation and maintenance
- Mechanical Features
 - Inlet Butterfly Isolation Valve
 - Discharge Butterfly Isolation Valve
 - Silent Check Valve
- Enclosures / External Connections
 - Marine Grade Aluminum Enclosure
 - Polyester Powder-Coated Steel Deck and Piping
 - Thermostat and Fan on Mechanical Enclosure
- Pump Control
 - Pump Start Relay
 - VFD - Variable Frequency Drive for Control of Pressure
- Display
 - Monochrome Touch Screen Display

Optional Features and Accessories

Visit: www.rainbird.com/professionals/products/pumps-pump-stations

Models

- **Horizontal End Suction - LP Series**
 - 5 to 10 HP; Up to 100 psi (6.9 bar); Up to 200 gpm (12.6 lps, 45.4 m³/h)
- **Vertical Multistage - LP Series**
 - 1 to 7.5 HP; Up to 120 psi (8.3 bar); Up to 90 gpm (5.7 lps, 20.4 m³/h)

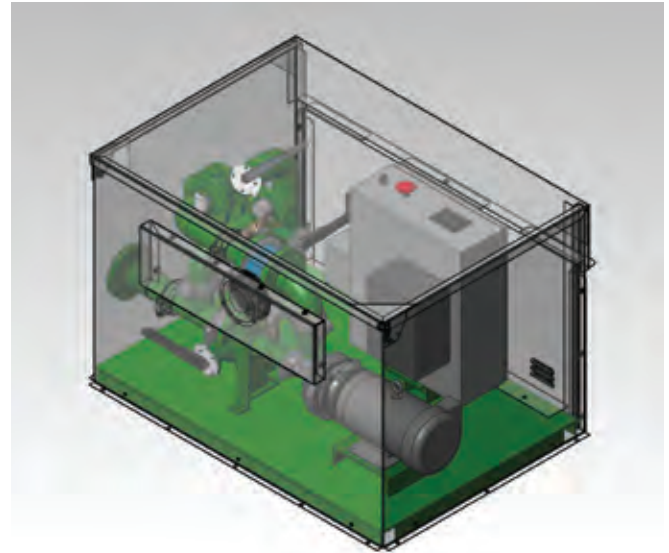

Horizontal End Suction - LP Series Shown
 5 to 10 HP; Up to 100 psi (6.9 bar);
 Up to 200 gpm (12.6 lps, 45.4 m³/h)

LP Series – Horizontal End Suction - 1 Pump – Aluminum Enclosure

Motor Size	5 HP	7.5 HP	10 HP
Pump Type	Horizontal End Suction		
Power Requirement	480/60/3 V/HZ/PH		
	208-230/60/3 V/HZ/PH		
	208-230/60/1 V/HZ/PH		
Inlet Pressure Requirement	Suction Lift or Boost Applications		
Outlet Pressure	Up to 100 psi (6.9 bar) ⁽¹⁾		
Outlet Flow	Up to 200 gpm (12.6 lps, 45.4 m ³ /h) ⁽¹⁾		
Concrete Slab Dimensions (min)	65" x 49" (165 cm x 125 cm)		
Platform Skid Dimensions (min)	53" x 39.75" (135 cm x 101 cm)		
Inlet / Discharge Size	2" Flange Fitting (adapter)	3" Flange Fitting	4" Flange Fitting (adapter)
Cabinet Height (from slab)	35" (89 cm)		

LP Series – Vertical Multistage – 1 Pump – Aluminum Enclosure

Motor Size	1 HP	1.5 HP	2 HP	5 HP	7.5 HP
Pump Type	Vertical Multistage				
Power Requirement	480/60/3 V/HZ/PH				
	208-230/60/3 V/HZ/PH				
	208-230/60/1 V/HZ/PH				
Inlet Pressure Requirement	Suction Lift or Boost Applications				
Outlet Pressure	Up to 120 psi (8.3 bar) ⁽¹⁾				
Outlet Flow	Up to 90 gpm (5.7 lps, 20.4 m ³ /h) ⁽¹⁾				
Concrete Slab Dimensions (min)	65" x 49" (165 cm x 125 cm)				
Platform Skid Dimensions (min)	53" x 39 3/4" (135 cm x 101 cm)				
Inlet / Discharge Size	2" flange fitting standard - 3" and 4" adapters available				
Cabinet Height (from slab)	35" (89 cm) or 47" (107 cm)				

⁽¹⁾ Refer to pump performance curves, provided upon request from pumps@rainbird.com

Low to Medium Flow Pump Stations – D-Series

Rain Bird's single pump, Vertical Multi-Stage and Horizontal End Suction stations in powder-coated green enclosures are designed for small to midsize boost, flooded suction and suction lift applications such as city parks and buildings, sports fields, commercial buildings, small home owner's associations and large residential sites. Its small footprint, durable centrifugal or multistage pump configuration, and choice of options make it an ideal choice for Turf irrigation applications.

Standard Features

- Reliability – Integrated Plug-n-Pump provide single source responsibility for the entire pumping system insuring trouble-free installation and operation
- Energy efficient – Variable Frequency Drive (VFD) maintains constant pressure at varying flow demand
- Inlet and discharge isolation valves for easier mechanical serviceability
- Easy Start-up – All stations are water-tested at the factory prior to shipment.
- Mechanical Features
 - Inlet Butterfly Isolation Valve
 - Discharge Butterfly Isolation Valve
 - Silent Check Valve
- Pressure / Flow
 - Stainless Steel Pressure Transducer
 - Flow Switch
- Enclosures / External Connections
 - Polyester Powder Coated Steel Enclosure
 - Polyester Powder-Coated Steel Deck and Piping
 - Re-Prime Piping (Suction Lift only)
 - Thermostat and Fan on Mechanical Enclosure
- Pump Control
 - Pump Start Relay
 - VFD - Variable Frequency Drive for Control of Pressure
- Display
 - Monochrome Touch Screen Display
 - Optional Color Touch Screen Display with Remote Communication Capability

Optional Features and Accessories

Visit: www.rainbird.com/professionals/products/pumps-pump-stations

Models

- **Horizontal End Suction - 1 Pump - D Series**
 - 5 to 20 HP; Up to 130 psi (9.0 bar); Up to 180 gpm (11.4 lps, 40.9 m³/h)
- **Vertical Multistage – 1 Pump – D Series**
 - 3 to 15 HP; Up to 120 psi (8.3 bar); Up to 200 gpm (12.6 lps, 45.4 m³/h)

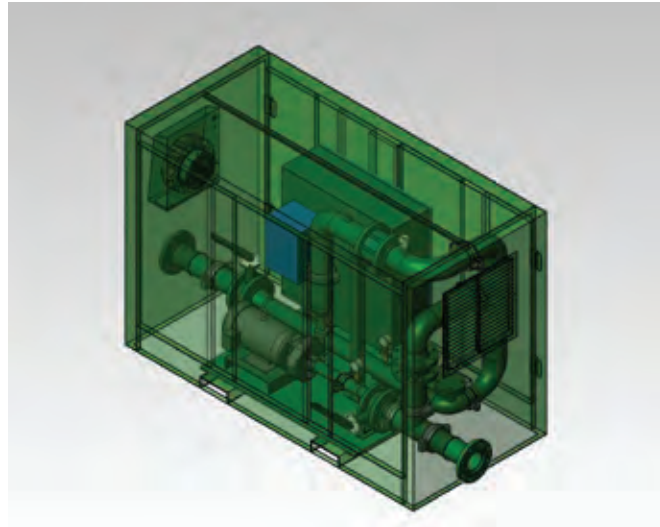

Horizontal End Suction - 1 Pump - D Series shown
5 to 20 HP; Up to 130 psi (9.0 bar);
Up to 350 gpm (22.1 lps, 79.5 m³/h)

D-Series – Horizontal End Suction – 1 Pump – Green Enclosure

Motor Size	5 HP	7 ½ HP	10 HP	15 HP	20 HP
Pump Type	Horizontal End Suction				
Power Requirement	480/60/3 V/HZ/PH				
	208-230/60/3 V/HZ/PH				
Inlet Pressure Requirement	230/60/1 V/HZ/PH				
	208/60/1 V/HZ/PH				
Inlet Pressure Requirement	Suction Lift (up to 3 ft. lift), or Boost Applications				
Outlet Pressure	Up to 130 psi (9.0 bar) ⁽¹⁾				
Outlet Flow	Up to 350 gpm (22.1 lps, 79.5 m ³ /h) ⁽¹⁾				
Concrete Slab Dimensions (min)	90" x 48" (229 cm x 122 cm)				
Platform Skid Dimensions (min)	78" x 36" (198 cm x 91 cm)				
Inlet / Discharge Size	4" standard - 2", 3" and 6" adapters are external accessories				
Cabinet Height (from slab)	52" (132 cm) or 64" (163 cm)				

D-Series – Vertical Multistage – 1 Pump – Green Enclosure

Motor Size	3 HP	5 HP	7 ½ HP	10 HP	15 HP
Pump Type	Vertical Multi-Stage				
Power Requirement	480/60/3 V/HZ/PH				
	208-230/60/3 V/HZ/PH				
Inlet Pressure Requirement	208-230/60/1 V/HZ/PH				
	Suction Lift or Boost Applications				
Outlet Pressure	Up to 120 psi (8.3 bar) ⁽¹⁾				
Outlet Flow	Up to 180 gpm (11.4 lps, 40.9 m ³ /h) ⁽¹⁾				
Concrete Slab Dimensions (min)	90" x 48" (229 cm x 122 cm)				
Platform Skid Dimensions (min)	78" x 36" (198 cm x 91 cm)				
Inlet / Discharge Size	4" Standard - 2", 3", and 6" adapters available				
Cabinet Height (from slab)	52" (132 cm) or 64" (163 cm)				

⁽¹⁾ Refer to pump performance curves, provided upon request from pumps@rainbird.com

Medium Flow Pump Station

Rain Bird's single pump, Vertical Multi-Stage Enhanced station in a compact enclosure is designed for medium-flow boost, flooded suction and suction lift applications, such as; parks, sports complexes, golf courses, turf farms and other agricultural projects. Its compact design, durable centrifugal pump configuration, choice of options and enclosures make it an ideal choice for Turf irrigation applications with flows up to 500 gpm (31.5 lps, 114 m³/h).

Standard Features

- Entry Level through High Performance
- Control Package – With either a cost-effective monochrome touch-panel display or high resolution color touch-panel display for improved user interfaced and remote monitoring via VNC (Virtual Network Computing)
- Energy efficient – Variable Frequency Drive (VFD) maintains constant pressure at varying flow demand
- Enhanced Serviceability – Modern electrical design utilizing industrial breaker motor protection instead of fuses. Industrial circuit breakers are quickly reset and designed for an extended service life
- Inlet and discharge isolation valves for easier mechanical serviceability
- Plumbing Configurations
 - Inlet and Discharge Piping on same side of the enclosure (as shown)
- Mechanical Features
 - Inlet Butterfly Isolation Valve
 - Discharge Butterfly Isolation Valve
 - Pump Isolation Valve
 - Silent Check Valve
- Pressure / Flow
 - Stainless Steel Pressure Transducer
 - Flow Switch
- Enclosures / External Connections
 - Marine Grade Aluminum Enclosure
 - Polyester Powder-Coated Steel Deck and Piping
 - Thermostat and Fan on Mechanical Enclosure

Optional Features

Visit: www.rainbird.com/professionals/products/pumps-pump-stations

Models

- **Vertical Multi-Stage – 1 Pump Enhanced – Aluminum Enclosure**
 - 5 to 50 HP; Up to 150 psi (10.3 bar); Up to 500 gpm (31.5 lps, 114 m³/h)

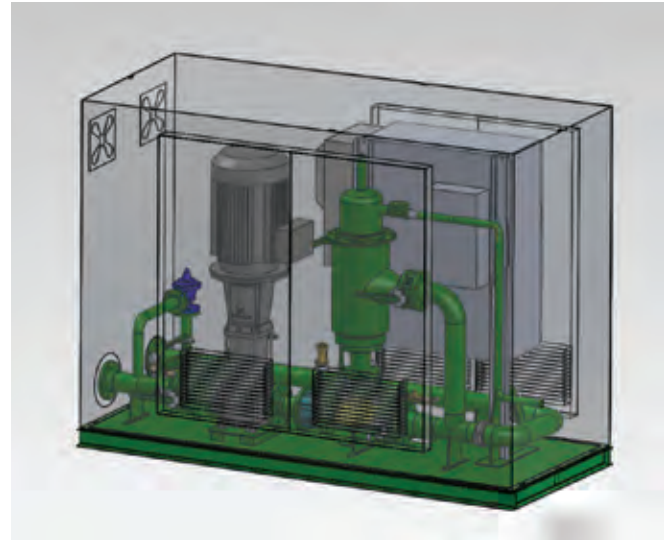

Vertical Multi-Stage – 1 Pump Enhanced – Aluminum Enclosure shown
 5 to 50 HP; Up to 150 psi (10.3 bar);
 Up to 500 gpm (31.5 lps, 114 m³/h)

Vertical Multi-Stage – 1 Pump Enhanced – Aluminum Enclosure										
Motor Size	5 HP	7.5 HP	10 HP	15 HP	20 HP	20 HP	25 HP	30 HP	40 HP	50 HP
Pump Type	Vertical Multi-Stage									
Power Requirement	208-230/1/60 V/PH/HZ									
Power Requirement (Other power configurations available upon request)	208-230/3/60 V/PH/HZ									
	480/3/60 V/PH/HZ									
	575/3/60 V/PH/HZ									
Inlet Pressure Requirement	Suction Lift or Boost Applications									
Outlet Pressure	Up to 150 psi (10.3 bar) ⁽¹⁾									
Outlet Flow	Up to 500 gpm (31.5 lps, 114 m ³ /h) ⁽¹⁾									
Concrete Slab Dimensions (min)	10' 3" x 4' 9" (312.4 cm x 145 cm)									
Platform Skid Dimensions (min)	9' 3" x 3' 9" (281 cm x 114.3 cm)									
Inlet / Discharge Size	4" Flanges Standard, 6" Inlet Flange (Suction Lift), 3", 4", 6", 8" Adapters Available									

(1) Refer to pump performance curves, provided upon request from pumps@rainbird.com

Main Irrigation Pump Stations

Flows Up to 7000 GPM

Reliable Variable Frequency Drive Pump Stations designed to serve as the main irrigation pump station for golf courses and large commercial sites. Rain Bird's Pump Station Platforms are designed for both new construction projects and renovation projects

Available in the following configurations:

- Vertical Turbine Pump Stations for Wet-well Applications
- Horizontal End Suction for Flooded Suction and Pressure Boosting Applications
- Vertical Multistage Pumps for Flooded Suction, Suction Lift, and Pressure Boosting Applications

Benefits:

- Enhanced Serviceability: Modern electrical design utilizing industrial breaker motor protection instead of time-wasting fuses. Industrial circuit breakers are quickly reset and designed for an extended service life
- Reduced Downtime: Industrial circuit breakers are good for thousands of trips
- Easy Operator Training: Multi-language color touch-screen that is easy to learn
- Superior Corrosion Resistance; Choice of Polyester Powder Coated or Marine Grade Aluminum deck for the highest level of corrosion resistance. Less corrosion equals longer pipe, skid, and manifold life, reducing cost
- No-Hassle Buying: Get everything you need for your irrigation system construction or renovation from the only manufacturer dedicated to irrigation for over seven decades
- Real-Time Communication: The pump station communications in real-time with the central, allowing the central to make immediate decisions to maximize the efficiency of the entire irrigations systems

Electrical Power Specifications:

- 60 Hz, 3-Phase Power: 208V - 230V (up to 60HP per pump), 460V, 575V
- 50 Hz, 3-Phase Power: 380V, 415V
- Other power configurations available upon request

Many options to choose from include:

- Air Conditioned Electrical Panel Cooling System
- Enclosures: Aluminum, Painted Steel (Government Specified Colors)
- Fertigation Systems
- Filtration: Backwashing Screen Filters and Suction Scan Filters (Hydraulic or Electric)
- Heater, Skid Mounted
- Intake Box Screen with 3 Stainless Steel Screens
- Intermediate Pump
- Lake Level Control: Float Switches and Level Transducer
- Magnetic Flow Meter
- Modem, Radio, Hard-wired or Cellular Gateway connection
- Power Zones
- Premium Efficient Motors
- VFD per pump
- Wye Strainer with Auto Back-flush
- Z Discharge Pipe



Pump Manager with SmartPump™

- Combine a Rain Bird Pump Station and central control software to fully integrate pump station operation with your central control. This combination allows the pump station and central control to respond to changes in the system and irrigation immediately, providing the highest level of efficiency
- Smart Pump™ matches the irrigation system operation with the real capacity of the pump station, shortening the water window by an average of 20 percent and decreasing energy consumption. In addition, Smart Pump alerts the superintendent in real time of irrigation and pump station problems via cell phone text messaging. When an issue occurs such as an irrigation pipe break, the system verifies the break, shuts down the system and notifies the superintendent. Other systems cannot respond in a timely manner and can lose an hour of irrigation time trying to recover from a system fault



Need Help Specifying a Pump?

- Email pumps@rainbird.com or call 520-806-5620 for assistance with quotes and specifications

Pump Start Relays

For Optimum Pump Performance and Protection

Rain Bird Pump Start Relays (PSRs) provide worry free performance for your irrigation system and are compatible with Rain Bird and other reliable irrigation controllers.

Dual Voltage Pump Start Relay Features

- Works with a lawn controller's start/stop command to facilitate the electrical path from the breaker box to the pump motor
- Provides "pilot duty" operation for all types of electrically driven pump equipment with available coil voltages of 24, 110 and 220 VAC
- 40 AMP certified relay
- Quick connect terminals with wire nuts
- Grounding provision
- Compatible with 24 VAC timed lawn controllers
- Compatible with 110 or 220 VAC 3/4 HP thru 5 HP* single phase pumps
- Grey "baked-on" powder coating, for long life in difficult environments
- UL Listed as "Enclosed Industrial Control Panels" and backed by a one-year warranty
- Housed in compact NEMA3R weather-tight enclosures
- Not recommended for use with 2-wire controller/decoder systems

Model

- PSR110220

2-Wire Pump Start Relay Features

- Works with a lawn controller's start/stop command to facilitate the electrical path from the breaker box to the pump motor
- Provides "pilot duty" operation for all types of electrically driven pump equipment with available coil voltages of 24, 110 or 220 VAC
- 40 AMP certified relay
- Quick connect terminals with wire nuts
- Grounding provision
- Compatible with 24 VAC timed lawn controllers
- Compatible with 110 or 220 VAC 3/4 HP thru 5 HP* single phase pumps
- Grey "baked-on" powder coating, for long life in difficult environments
- UL Listed as "Enclosed Industrial Control Panels" and backed by a one-year warranty
- Housed in compact NEMA3R weather-tight enclosures
- Includes an additional ice cube relay for 2-wire controller/decoder systems

Models

- PSR1101C or PSR2201C

* when thermal protection is present

Pump Start Relays Specifications

Model	Line Voltage	Coil Voltage	hp
PSR1101C	110	24	3/4 through 2*
PSR2201C	220	24	3/4 through 5*
PSR110220	110 or 220	24	3/4 through 5*

* National electrical code (nec) states all motors will be thermally protected from excessive "amperage draw." Most motors under 2 hp are supplied with thermal protection from the motor manufacturer. For motors over 2 hp, code-compliant PSRB pump protection is recommended.

NOTE: Circuit breakers are never classified as motor protection

NOTE: Check with your local health department for regulations and requirements for backflow prevention.



PSR110220



PSR1101C
or
PSR2201C

"G-Series" Hydraulic Suction Scanning Screen Filter

Economy and Value with Lower Backwash Volumes

Features

- Provides worry free medium-flow rate filtered water quality
- Powered by source line water pressure, the filter's backwashing system produces a concentrated high velocity and low volume reverse water flow to systematically clean the screen of any entrapped contaminants
- Models are available as a filter unit only, or as a filter assembly including bypass plumbing and valves for fast and easy installation on site
- Heavy-duty, durable, SS woven wire mesh screen filtration element with PVC support is supplied standard. Optional screen construction including multi-layer sintered SS and wedgewire are also available upon request. HT models only supplied with sintered SS
- Standard: 200 micron. Optional: 50 - 2000 micron. Flow rates will vary with screen size and water source. Max flow assumes good water quality (< 20 ppm solids) and 200 micron screen
- Standard flow rates from 100 to 2,640 GPM
- Standard maximum operating pressure of 150 PSI (higher pressures optionally available)
- Filtered, clean water backwashing initiated automatically by time or pressure differential via integrated Rain Bird F2 AC/DC Controller
- Flanged inlet and outlet standard except on HO-G-02 and HT-G-02 filter only configurations which are threaded. Grooved inlet and outlet configuration optionally available
- Vessel Material (based on model): Powder Coated Carbon Steel or 304 Stainless Steel, 316 SS and Duplex SS optional
- Available as filter only, or as a complete assembly with bypass manifold and valves. Higher pressures optionally available.



G-Series
(Shown with integrated
bypass assembly and
optional wye-strainer)

G-Series
(Shown as
filter only)

"G-Series" Suction Scanning Screen Filter Performance Data

Powder Coated Carbon Steel Model Number	Stainless Steel Model Number	SS Mesh Screen Area (in ²)	Sintered Screen Area (in ²)	Max Flow (GPM)	Max Flow (m ³ /hr)	Max Pressure (psi)	Inlet / Outlet Flange Size (in)	Flush Valve Size	Minimum Inlet Pressure During Rinse Cycle (psi)
HO-G-02-LE-C	HO-G-02-LE-S	64		100	22.7	150	2	1"	35
HO-G-03-LE-C	HO-G-03-LE-S	120		200	45.4	150	3	1"	35
HO-G-04-LS-C	HO-G-04-LS-S	120		300	68.1	150	4	1"	35
HO-G-04-LE-C	HO-G-04-LE-S	466		500	113.6	150	4	1.5"	35
HO-G-06-LS-C	HO-G-06-LS-S	466		750	170.3	150	6	1.5"	35
HO-G-08-LS-C	HO-G-08-LS-S	648		1300	295.3	150	8	1.5"	35
HO-G-08-LE-C	HO-G-08-LE-S	810		1320	299.8	150	8	2"	35
	HT-G-02-LE-S		216	200	45.4	150	2	1"	35
	HT-G-02-LEX-S		432	300	68.1	150	2	1"	35
	HT-G-03-LE-S		216	200	45.4	150	3	1"	35
	HT-G-04-LS-S		432	500	113.6	150	4	1"	35
	HT-G-04-LE-S		720	600	136.3	150	4	1"	35

Contact Rain Bird for drawings or visit www.rainbird.com to download.

Filter flow is based on 200 micron or greater filtration of clear irrigation water (< 20 ppm solids). Appropriate flow de-rating is required for excessive debris loads (silt, organics, algae, etc.), reclaim water and finer screens. Water sources with chlorides over 175 PPM and free chlorine over 2 mg/l require special construction materials. Contact Rain Bird for filter selection assistance for these applications.

"I-Series" Hydraulic Suction Scanning Screen Filter

Irrigation Uses

Self-cleaning, line powered hydraulic water filters for turf, landscape, agriculture, greenhouse, golf course and nursery applications.

Features

- Flow Rate: 300 – 7,500 gpm
- Max Temperature: 210° F
- Single SS electric ball valve for flushing operations standard
- Heavy-duty, durable, 316 SS woven wire mesh screen filtration element with PVC support is supplied standard. Optional screen construction including multi-layer sintered 316 SS and wedgewire are also available upon request. HT models only supplied with sintered SS.
- Screen opening: 50µ – 2000µ
- Working pressure: 40 – 150 psi
- Vessel Material (based on model): Powder Coated Carbon Steel or 304 Stainless Steel, 316 SS and Duplex SS optional
- Available as filter only, or as a complete assembly with bypass manifold and valves. Higher pressures optionally available.

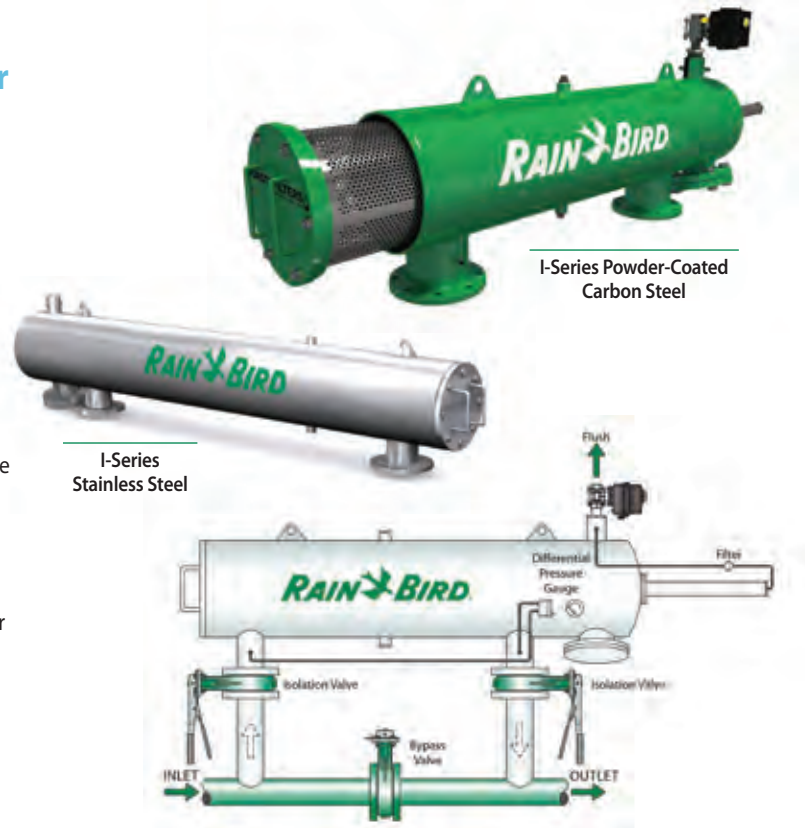

"I-Series" Suction Scanning Screen Filter Performance Data

Powder Coated Carbon Steel Model Number	Stainless Steel Model Number	Line Size (in)	300	200	120	100	Micron Mesh	Sintered Screen Area (in ²)	Rinse Duration (Seconds)	Flush Volume (Gallons)	Flush Valve Size (in)	Minimum Inlet Pressure During Rinse Cycle (psi)
			Std. Flow Rate (gpm)	Std. Flow Rate (gpm)	Std. Flow Rate (gpm)	Std. Flow Rate (gpm)						
HO-I-03-PS-C-M	HO-I-03-PS-S-M	2	300	300	300	260	254	390	12 to 16	≈ 35	1.5	40
HO-I-04-PS-C-M	HO-I-04-PS-S-M	4	500	500	500	420	413	620	12 to 16	≈ 35	1.5	40
HO-I-06-PS-C-M	HO-I-06-PS-S-M	6	750	750	580	420	413	620	12 to 16	≈ 35	1.5	40
HO-I-08-PM-C-M	HO-I-08-PM-S-M	8	1000	830	580	420	413	620	12 to 16	≈ 35	1.5	40
HO-I-08-PS-C-M	HO-I-08-PS-S-M	8	1400	1240	880	650	614	930	12 to 16	≈ 65	2	40
HO-I-10-PS-C-M	HO-I-10-PS-S-M	10	2000	1300	920	675	614	930	12 to 16	≈ 65	2	40
HO-I-12-PS-C-M	HO-I-12-PS-S-M	12	2750	1800	1200	850	826	1240	12 to 16	≈ 65	2	40
HO-I-14-PS-C-M	HO-I-14-PS-S-M	14	3750	1950	1300	875	826	1240	12 to 16	≈ 65	2	40
Bypass Manifold												
	HT-I-03-LP-S-M	3	300	300	300	300		360	12 to 16	≈ 12	1	40
	HT-I-04-PE-S-M	4	600	600	600	600		720	12 to 16	≈ 35	1.5	40
	HT-I-06-PE-S-M	6	800	800	800	720		720	12 to 16	≈ 35	1.5	40
	HT-I-08-PS-S-M	8	1400	1400	1400	1000		1008	12 to 16	≈ 35	1.5	40
	HT-I-08-PE-S-M	8	1500	1500	1500	1152		1152	12 to 16	≈ 65	2	40
	HT-I-10-PE-S-M	10	3200	3200	2520	1800		1800	12 to 16	≈ 65	2	40
	HT-I-12-PS-S-M	12	3400	3400	2550	1850		1820	12 to 16	≈ 65	2	40
	I-3-CS-T	3	300									
	I-4-CS-F	4	600									
	I-6-CS-F	6	800									
	I-8-CS-F	8	1500									
	I-10-CS-F	10	3200									
	I-12CS-F	12	3400									
	I-14-CS-F	14	3750									

Contact Rain Bird for drawings or visit www.rainbird.com to download.

Filtered, clean water backwashing initiated automatically by time or pressure differential via integrated Rain Bird F2 AC/DC controller or Filtron 110 controller (based on application).

The calculated flow rates above are based on average clear lake quality water (< 40 ppm solids). For good, poor or bad water contact Rain Bird. Drawings of standard filter models are available at www.rainbird.com. Standard Rain Bird controllers: F2 AC/DC or Filtron 110 (I-series filters integrated with a Rain Bird Pump station are controlled by pump station PLC).

Water sources with chlorides over 175 PPM and free chlorine over 2 mg/l require special construction materials. Contact Rain Bird for filter selection assistance for these applications.

PSS Series Self-Cleaning Pump Suction Screen

Keep Debris Out of Your Pump and Irrigation System

Features

- Galvanized, Self-Cleaning Pump Suction Screen removes large trash and debris from water sources, saving time and money in energy, pumping efficiency and maintenance costs
- All water must pass through the pump suction screen attached to the end of the pump suction line before entering the pump intake pipe. A small, side-stream from the pump discharge plumbing drives two spray bars that continually rotate, jetting water at the screen and blasting debris away
- Heavy 12 mesh stainless steel screen increases your pump efficiency for many years to come

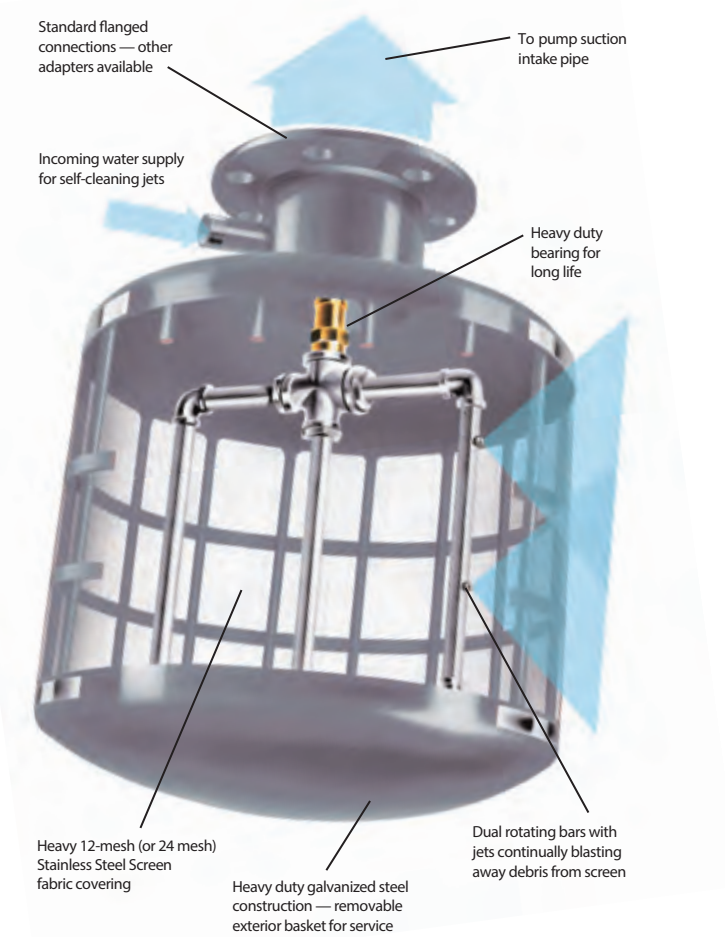

12 Mesh Self-Cleaning Pump Suction Screen Performance Data

Model Number	Flow US GPM	Flow m ³ /Hour	Screen Length (in)	Total Length (in)	Screen Diameter (in)	Flange Size (in)	Return Inlet Pipe Size (in)	Operating Pressure (min - max psi)	Weight Lbs.	Cleaning Spray (GPM)
12 Mesh Filter										
PSS200	325	73.8	11	25	16	4	1.5	35-100	38	20
PSS400	550	124.9	15	28.8	16	6	1.5	40-100	57	20
PSS600	750	170.3	16	32.5	24	8	1.5	40-100	101	20
PSS800	950	215.7	18	34.5	24	10	1.5	45-100	108	20
PSS1000	1350	306.5	23	39.5	24	10	1.5	50-100	116	24
PSS1400	1650	374.6	26	42.5	24	12	1.5	55-100	128	24
PSS1700	1950	442.7	28	44.5	26	12	1.5	55-100	148	24
PSS2000	2350	533.5	32	48.5	26	14	1.5	60-100	160	24
PSS2400	2600	590.2	35	52.5	30	16	1.5	65-100	223	28
PSS3000	3000	681.0	40	57.5	30	16	1.5	40-65	236	44
PSS3500	3500	794.5	40	59.5	36	18	1.5	40-65	283	44
PSS4000	4000	908.0	40	63.5	42	18	1.5	40-65	358	44

Contact Rain Bird for drawings or visit www.rainbird.com to download.

CS Series Centrifugal Sand Separator

Remove contaminants to minimize required maintenance and increase efficiency

Features

- Capacities of 4 to 8300 gpm
- Simple installation (no electrical power required)
- Efficient pre-filter to reduce sand load on downstream components
- Rain Bird Centrifugal Sand Separators are designed to separate abrasive particles before they can enter the irrigation system, keeping equipment clean and clear of debris, which minimizes the amount of maintenance required and increases operational efficiency
- The separator removes sand and particles that are heavier than water (materials with a specific gravity of 2 or greater)
- Liquids and solids enter the unit and begin traveling in a circular flow. This centrifugal action throws heavier particulates towards the filter walls and eventually downward in a spiral motion to the separation chamber. The particulates collect in the separation chamber and are purged manually from the system. The filtered water is then drawn to the separator's vortex and through the outlet
- An optional automatic purge controller and valve can be used on all applications to automate the purge process, which eliminates the need for manual flushing. Small vertical design separators may be wall mounted or supported by the system piping



Centrifugal Sand Separator

Centrifugal Sand Separators Performance Data

Model Number	Flow* US GPM	Flow m ³ /Hour	Inlet / Outlet Line Size (in)	Length (in)	Length (cm)	Weight Lbs.	Max. Particle Size (in)	Flush Valve Size (in)
Vertical Separators								
VCS-R5V	4 - 10	0.9 - 2.3	0.5	20	50.8	13	0.625	1
VCS-R7V	10 - 20	2.3 - 4.6	0.75	20	50.8	15	0.375	1
VCS-R10V	18 - 38	4 - 8.7	1	30.5	77.5	26	0.5	1
VCS-R12V	26 - 52	6 - 12	1.25	30.5	77.5	26	0.5	1
VCS-R15V	38 - 79	8.7 - 18	1.5	30.5	77.5	26	0.5	1
VCS-R20V	63 - 120	14.5 - 27.6	2	36	91.4	44	0.5	2
VCS-R25V	100 - 180	23 - 41.4	2.5	44	111.8	55	0.5	2
VCS-R30V	125 - 260	28.8 - 59.8	3	48	121.9	75	0.5	2
VCS-R40V	190 - 345	43.7 - 79.4	4	52	132.1	120	0.5	2
Angled Separators								
ACS-R40LA	200 - 525	46 - 120	4	80	221	280	1.5	2
ACS-R60LA	365 - 960	84 - 220	6	106.25	293.4	493	1.5	2
ACS-R80LA	800 - 1600	184 - 369	8	114	316.9	722	1.5	2
ACS-R100LA	1300 - 2300	299 - 529	10	123.5	342.9	840	1.5	2
ACS-R120LA	2025 - 3400	465 - 782	12	139	396.2	1400	1.5	2
ACS-R140LA	2975 - 5000	684 - 1150	14	148	424.2	1550	2	2
ACS-R160LA	4000 - 6200	920 - 1426	16	160	462.3	1850	2	2
ACS-R180LA	5100 - 8300	1173 - 1909	18	177	462.3	2400	2	3

HDF Series Disc Filters

Automatic self-cleaning disc filtration equipment

Features

- Automatic self-cleaning disc filtration equipment with 2" valves and high density polyethylene manifolds
- Ideal for surface and well water containing both organic (algae) and inorganic materials: rivers, reservoirs, canals, waste water, and well water containing light sand (<3PPM) and other contaminants
- The patented system's helical action provides efficient cleaning
- Manufactured from engineered plastics to resist rust and corrosion from chemicals and water
- All units are factory tested prior to shipment
- Disc elements provide depth filtration -not just surface filtration
- Unit is pre-assembled with HDPE (High -density polyethylene) manifold for easy installation
- DP, time or manual backflush cycle can be imitated from the controller
- Plastic backflush valves are lightweight and corrosion resistant
- Low maintenance and performs reliable backflush
- Filtration disc versatility (filtration grades can be easily changed)
- Available with 100, 130, 200 or 400 micron discs (specify when ordering)

Rain Bird HDF Series 1X2 filter backwash.

- **FILTRATION STAGE:** As water goes through the discs, particles are projected away due to the cyclone effect, reducing the backflushing frequency
- **BACKFLUSHING STAGE:** Water is projected through the discs, expelling the retained particles and evacuating them through the drainage manifold while the rest of the equipment is still in the filtration stage, supplying the remaining installation

Rain Bird HDF Series-2 systems backwashes one station at a time while the remaining elements continue filtering.

- **FILTRATION STAGE:** As water goes through the discs, particles are projected away and kept in suspension due to the cyclone effect, reducing the backflushing frequency
- **BACKFLUSHING STAGE:** Water is projected through the discs, expelling the retained particles and evacuating them through the drainage manifold. The rest of the filters battery continue filtering.

The filtration process restarts when the discs recompress. The backflush process is controlled by the Rain Bird Control Unit

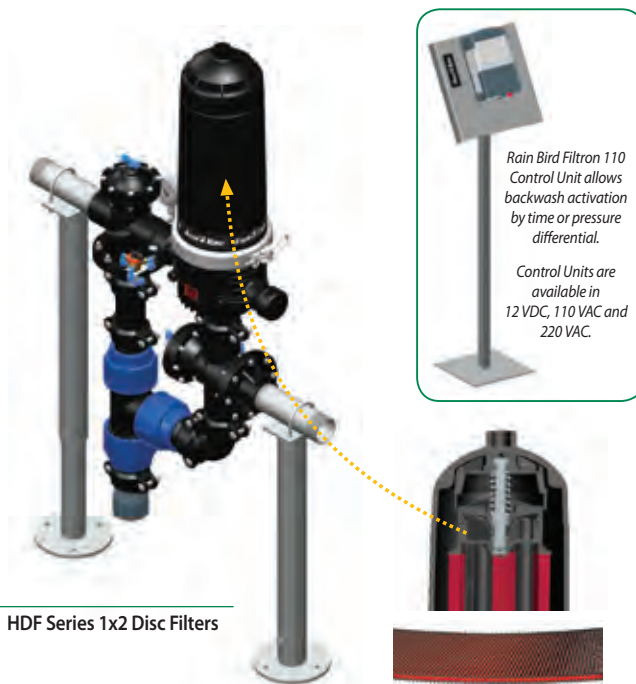

HDF Series 1x2 Disc Filters



HDF Series-2 Disc Filters



HDF Series 4 Disc Filters

Specifications

HDF Series 1x2 Disc Filters

- Suited for areas with or without electricity.
- Ideal where manual cleaning is troublesome.
- Compact design fits in tight spaces.
- Control Unit functions on pressure differential or time.
- Automatic self-cleaning 2" filter for low flow ranges.
- Maximum Flow: 106 gpm (24 m³/h)
- Maximum filtering surface (231 in²/1492 cm²).
- Maximum pressure: 145 psi (10 bar)
- Maximum temperature: 140° F (60° C)
- Standard 100 micron : Optional 130, 200 or 400 micron.

HDF Series 2 Disc Filters

- Suitable for surface and well waters containing both organic (algae) and inorganic materials.
 - Rivers, reservoirs, canals and waste water
- Well water containing light sand (<3 PPM) and other contaminants.
- Maximum flow: 848 gpm (192 m³/h) - 106 gpm (24 m³/h) per filter element. Max flow is based on 200 micron discs and good water quality source (< 20 ppm solids). Flow is de-rated based on water source and filtration level. Consult Rain Bird for sizing information
- Maximum filtering surface: (231 in²/1492 cm²)
- Maximum pressure: 145 psi (10 bar)
- Maximum temperature: 140° F (60° C)
- Standard: 100 micron. Optional: 20, 50, 130, 200 or 400 micron.

Control Units

Rain Bird Filtron 11 O with integrated pressure differential switch allows backwash activation by time or pressure differential. Controllers are available in 12 VDC, 11 O VAC and 220 VAC.

HDF Series 1x2 Disc Filters Specifications

Model Number	Number of Filters	Manifold	Filtering Surface	
			(in)	(cm)
1X2/2G	1-2"	Inlet: 2" PVC Outlet: 2" NPT Drainage: 2: NPT	231	1492

HDF Series 2 Disc Filters Specifications

Model Number	Number of Filters	Manifold	Filtering Surface	
			(in)	(cm)
2X2/3G	2	3"- GROOVED	463	2,984
3X2/4G	3	4"- GROOVED	694	4,476
4X2/6G	4	6"- GROOVED	925	5,968
5X2/6G	5	6"- GROOVED	1,156	7,460
6X2/6G	6	6"- GROOVED	1,388	8,952
7X2/6G	7	6"- GROOVED	1,619	10,444
8X2/8G	8	8"- GROOVED	1,850	11,936

Drainage manifolds included.

Consult factory for other configurations.

Rain Bird reserves the right to change the characteristics of these products without prior notice.

HDF Series 4 Disc Filtration systems for flows over 848 GPM (192 m³/h) quoted upon request.

Rain Bird Filtration Controller



F2 AC/DC-P Specifications

INPUT
115 - 230VAC
12 - 15VDC
230VAC (optional)
OUTPUT
24VAC, 12VDC
FEATURES
Up to Two (2) stations plus master valve
Input voltage 115, 230 VAC (optional) 12VDC
Output selectable to operate 24VAC, 12VDC solenoids
Pressure differential (PD) gauge included
Fixed PD delay
Resettable backwash count
Resettable alarm
Plastic outdoor box
Periodic, manual, or pressure differential (PD) actuation
Accurate timing
Simple programming



Drainage

Water Saving  **Water Saving Tips**

- Installing a well-designed drainage system will result in the collection and capture of rain, runoff water and standing water from the site.
- The collected water can then be directed to an on-site storage tank, treated (if required) and pumped on an “as needed” basis to feed a Rain Bird water efficient irrigation system.
- Drainage systems can reduce damage to structures by directing water away from the foundation of the structure to a more desirable area on the site.
- A Rain Bird Drainage Pop-Up Valve (DPUV) can be installed at the lowest point of the piping network to allow for the collected water to slowly percolate into the soil and recharge the ground water supply.
- A properly installed drainage system can eliminate issues on the site caused by rushing or standing water which can result in soil erosion, plant disease and structural damage.
- Remember, water always runs downhill. Make sure that there is at least a 2% elevation difference between the high-end and the low-end of the drainage system.

Rain Bird Drainage Products

Ruggedly constructed and designed to work together, these drainage grates, basins, adapters, pipe, and accessories can help you efficiently manage water run-off for virtually any residential, light commercial or municipal site.

Three-Year Warranty

You need products that will last long after the job's done. That's why we stand behind our drainage products with the longest warranty in the drainage product category.

All Rain Bird drainage purchases qualify for valuable Rain Bird Rewards points.

Round Catch Basin

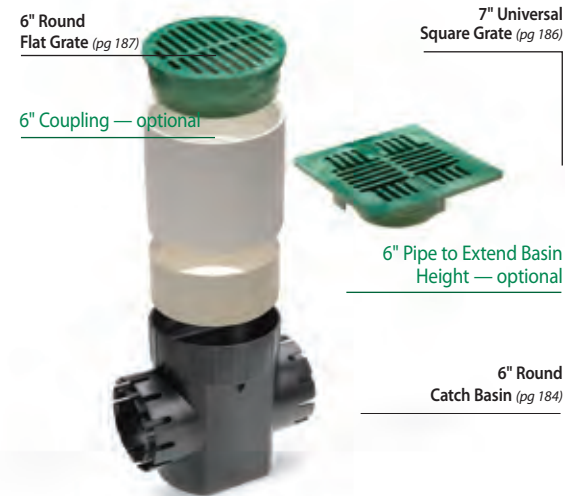

Compatible Drainage Pipe (not manufactured by Rain Bird)



Color, Size and Style are Optional. Loose Fits are Not.

No matter the job, you'll have the equipment you need to do it right. We offer grates and basins of varying dimensions, shapes and colors—all designed to fit together for tight, worry-free connections.

Recycled Plastics

All drainage models are constructed from 100% recycled plastic and therefore qualify for points on LEED projects.

Full Compatibility

Any way you put them together, our grates and basins will give you the best fit. For easy upgrades and quick replacements, our products are also compatible with components from most other drainage manufacturers.

Low-Profile Basin

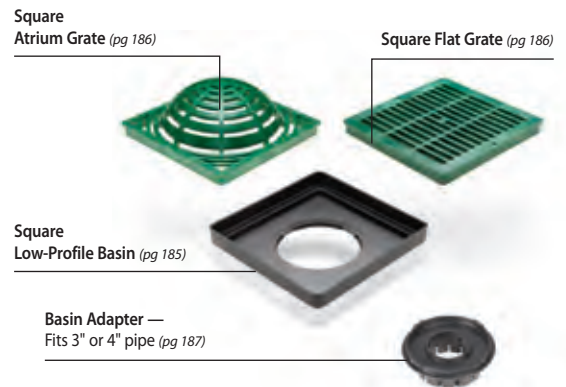

Square Catch Basin

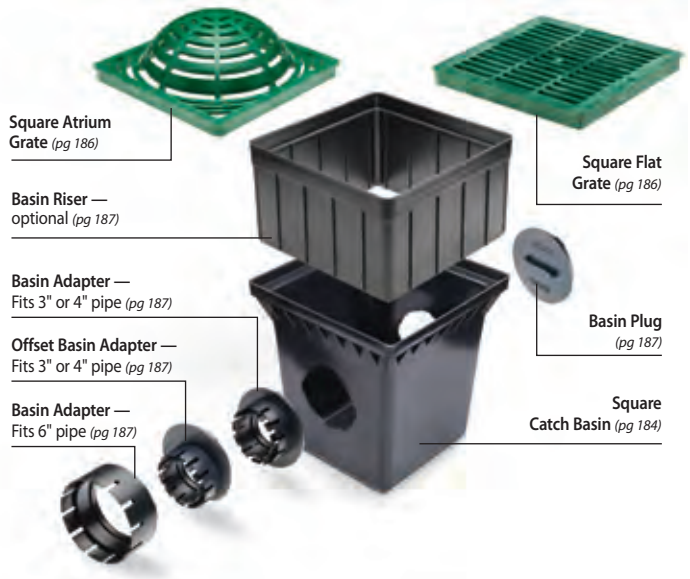

Round Catch Basins

Features

- Manufactured from High-Impact Polystyrene (HIPS)
- UV stabilized to protect from sun degradation
- Universal outlet(s) used to connect to 3" or 4" Sewer and Drain Pipe (ASTM D2729), 3" or 4" Corrugated Pipe and 3" or 4" Triple Wall Pipe
- Includes a sump to minimize clogging of pipes
- To extend height of basin, use 6" PVC Pipe (ASTM D2729 and ASTM D3034, SDR 35) as a riser



Model Number	Number of Outlets	Inlet (Top) Accepts	Outlet (Side) Fits	Capacity	Sump Capacity
6" Round, 1 Outlet or 6" Round, 2 Outlets					
DB6R1	1	<ul style="list-style-type: none"> • 6" Round Flat and Atrium Grates • 7" Universal Square Grates 	<ul style="list-style-type: none"> • 3" or 4" Corrugated Pipe • 3" or 4" Triple Wall Pipe 	0.80 gals	0.20 gals
DB6R2	2	<ul style="list-style-type: none"> • 6" PVC Pipe (ASTM D2729, ASTM D3034, SDR 35) 	<ul style="list-style-type: none"> • S & D Pipe (ASTM D2729) 		

Square Catch Basins

Features

- Manufactured from High-Density Polyethylene (HDPE)
- UV stabilized to protect from sun degradation
- Use a 3" and 4" Basin Adapter to connect basin to 3" or 4" Corrugated Pipe and 3" or 4" Triple Wall Pipe
- Use a 6" Basin Adapter to connect basin to 6" PVC Pipe (ASTM D2729 and ASTM D3034, SDR 35) and 6" Corrugated Pipe
- Use 9" or 12" Square Basin Riser(s) to extend height of 9" and 12" Square Catch Basins by 6" in height, respectively
- Accepts 9", 12" or 18" Square Flat and Square Atrium grates



Model Number	Number of Outlets	Inlet (Top) Accepts	Outlet (Side) Fits	Capacity	Sump Capacity
9" Square, 2 Outlets					
DB9S2	2	<ul style="list-style-type: none"> • 9" Square Flat Grates • 9" Square Basin Riser (DBRE9) 	<ul style="list-style-type: none"> • Basin Plug (DBAAP) • 3" & 4" Basin Adapter (DBAA34 or DBAAO34) • 6" Basin Adapter (DBAA6) 	2.20 gals	0.45 gals
12" Square, 2 Outlets					
DB12S2	2	<ul style="list-style-type: none"> • 12" Square Flat Grates • 12" Square Atrium Grates • 12" Square Basin Riser (DBRE12) 	<ul style="list-style-type: none"> • Basin Plug (DBAAP) • 3" & 4" Basin Adapter (DBAA34 or DBAAO34) • 6" Basin Adapter (DBAA6) 	5.10 gals	1.25 gals
18" Square, 2 Outlets					
DB18S2	2	<ul style="list-style-type: none"> • 18" Square Flat Grates 	<ul style="list-style-type: none"> • Basin Plug (DBAAP) • 3" & 4" Basin Adapter (DBAA34 or DBAAO34) • 6" Basin Adapter (DBAA6) 	16.70 gals	4.90 gals

Square Low-Profile Basins

Features

- Manufactured from High-Impact Polystyrene (HIPS)
- UV stabilized to protect from sun degradation
- One bottom outlet designed to accept all Basin Adapters
- Use a 3" and 4" Basin Adapter to connect to 3" or 4" Corrugated Pipe and 3" or 4" Triple Wall Pipe
- Use a 6" Basin Adapter to connect to 6" PVC Pipe (ASTM D2729 and ASTM D3034, SDR 35) and 6" Corrugated Pipe
- Accepts 12" Square Flat and Atrium Grates
- Includes two screw holes to enable grates to be secured to Low-Profile Basin
- Made in the USA

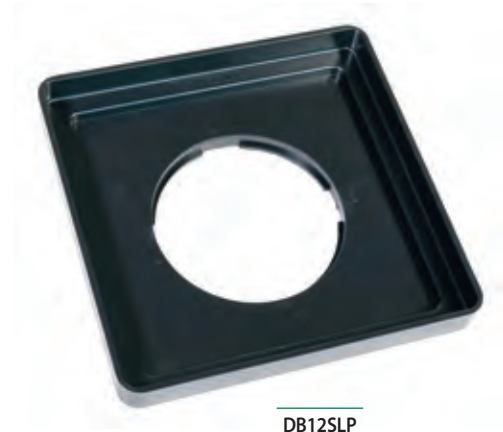

DB12SLP

Model Number	Inlet (Top) Accepts	Outlet (Side) Fits
12" Square		
DB12SLP	<ul style="list-style-type: none"> • 12" Square Flat Grates • 12" Square Atrium Grates • 12" Square Basin Riser (DBRE12) 	<ul style="list-style-type: none"> • 3" & 4" Basin Adapter (DBAA34 or DBAA034) • 6" Basin Adapter (DBAA6)

Square Basin Kits

For your convenience, Basin Kits are available with the most popular basin, grate and adapter components required on most jobs.

Model Number	Each Kit Includes	
9" Square Basin Kit		
DB9KITG	<ul style="list-style-type: none"> • 9" Square Basin with two outlets (DB9S2) • Two 3" and 4" Adapters (DBAA34) 	<ul style="list-style-type: none"> • Basin Plug (DBAAP) • 9" Square Flat Grate, GREEN (DG9SFG)
DB9KITB	<ul style="list-style-type: none"> • 9" Square Basin with two outlets (DB9S2) • Two 3" and 4" Adapters (DBAA34) 	<ul style="list-style-type: none"> • Basin Plug (DBAAP) • 9" Square Flat Grate, BLACK (DG9SFB)
12" Square Basin Kit (not shown)		
DB12KITG	<ul style="list-style-type: none"> • 12" Square Basin with two outlets (DB12S2) • Two 3" and 4" Adapters (DBAA34) 	<ul style="list-style-type: none"> • Basin Plug (DBAAP) • 12" Square Flat Grate, GREEN (DG12SFG)
DB12KITB	<ul style="list-style-type: none"> • 12" Square Basin with two outlets (DB12S2) • Two 3" and 4" Adapters (DBAA34) 	<ul style="list-style-type: none"> • Basin Plug (DBAAP) • 12" Square Flat Grate, BLACK (DG12SFB)



DB9KITG

Universal Square Grates

Features

- Manufactured from structurally foamed High-Density Polyethylene (HDPE)
- UV stabilized to protect from sun degradation
- Textured anti-skid surface
- Load rated for pedestrian traffic¹
- ADA compliant

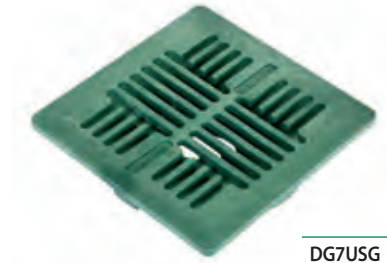

DG7USG

Model Number	Color	Fits	Open Slot Width	Open Surface Area	Maximum Flow Rating	Maximum Load
7" Universal Square Flat						
DG7USG	Green	<ul style="list-style-type: none"> • 6" Round Catch Basin (DB6R1, DB6R2) • 3" or 4" S & D Pipe (ASTM D2729) • 3" or 4" Corrugated Pipe • 3" or 4" Triple Wall Pipe • 3", 4" or 6" S & D Fittings (SDR 35) 	1/4"	13 sq in	11 GPM	250 lbs

¹Maximum load rating based on basin encased in concrete and weight uniformly applied across entire grate surface

Plastic Square Grates

Features

- Manufactured from structurally foamed High-Density Polyethylene (HDPE)
- UV stabilized to protect from sun degradation
- Flat and atrium (domed) profiles, available in two colors, green and black
- Each grate has three stepped diameters to fit Sewer and Drain (S & D) Pipe and Fittings, Triple Wall Pipe and Corrugated Pipe
- Textured anti-skid surface¹
- Load rated for autos and light trucks at speeds less than 20 mph^{1,2}
- ADA compliant¹

Flat

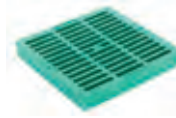

9"
DG9SFG

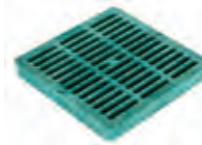

12"
DG12SFG



18"
DG18SFG

Atrium



12"
DG12SAG

Model Number	Color	Fits	Open Slot Width	Open Surface Area	Maximum Flow Rating	Maximum Load
9" Square Flat						
DG9SFG	Green	9" Square Catch Basin (DB9S2)	3/8"	38 sq in	50 GPM	2,000 lbs
DG9SFB	Black					
12" Square Flat						
DG12SFG	Green	12" Square Catch Basins (DB12S2 & DB12S4)	7/16"	53 sq in	70 GPM	3,000 lbs
DG12SFB	Black	12" Low-Profile Basin (DB12SLP)				
18" Square Flat						
DG18SFG	Green	18" Square Catch Basins (DB18S2 & DB18S4)	15/32"	92 sq in	120 GPM	4,000 lbs
DG18SFB	Black					
12" Square Atrium						
DG12SAG	Green	12" Square Catch Basins (DB12S2 & DB12S4)	7/16"	50 sq in	65 GPM	NA
DG12SAB	Black	12" Low-Profile Basin (DB12SLP)				

¹Flat grate only

²Maximum load rating based on basin encased in concrete and weight uniformly applied across entire grate surface

Plastic Round Grates

Features

- Manufactured from structurally foamed High-Density Polyethylene (HDPE)
- UV stabilized to protect from sun degradation
- 3" and 6" available in two colors, green and black
- Each grate has three stepped diameters to fit Sewer and Drain (S & D) Pipe and Fittings, Triple Wall Pipe and Corrugated Pipe
- Textured anti-skid surface¹
- Load rated for autos and light trucks at speeds less than 20 mph^{1,2}
- ADA compliant¹

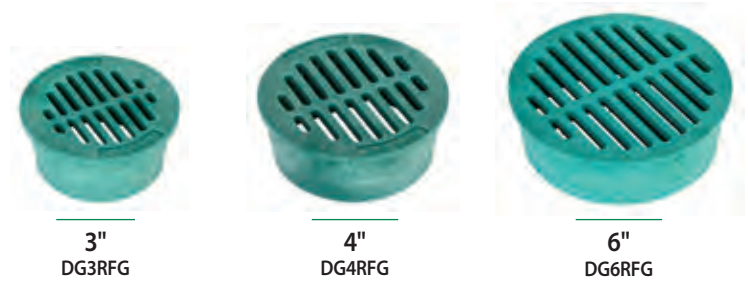

Model Number	Color	Each Diameter Fits			Open Slot Width	Open Surface Area	Maximum Flow Rating	Maximum Load
		Small	Medium	Large				
3" Round Flat								
DG3RFG	Green	3" Triple Wall Pipe	3" S & D Pipe (ASTM D2729)	3" S & D Fittings (SDR 35)	3/16"	3 sq in	3 GPM	500 lbs
DG3RFB	Black		3" Corrugated Pipe					
4" Round Flat								
DG4RFG	Green	4" Triple Wall Pipe	4" S & D Pipe (ASTM D2729) 4" Corrugated Pipe	4" S & D Fittings (SDR 35)	1/4"	5 sq in	6 GPM	750 lbs
6" Round Flat								
DG6RFG	Green	6" Sewer Pipe (ASTM D3034, SDR 35)	6" S & D Pipe (ASTM D2729)	6" S & D Fittings (SDR 35) 6" Round Catch Basins (DB6R1 & DB6R2)	5/16"	13 sq in	16 GPM	1,000 lbs
DG6RFB	Black		6" Corrugated Pipe					

¹Flat grate only ²Maximum load rating based on basin encased in concrete and weight uniformly applied across entire grate surface

Basin Adapters and Accessories



Model Number	Description	Use
DBAAP	Basin Plug	• Blocks 9", 12" & 18" Square Basin side outlets
DBAA34	3" and 4" Basin Adapter	• Adapts 9", 12" and 18" Square Basin side outlets and 9" & 12" Low-Profile Basin outlets to 3" or 4" PVC and Corrugated Pipe
DBAAO34	3" and 4" Offset Basin Adapter	• Adapts 9", 12" & 18" Square Basin side outlets and 9" & 12" Low-Profile Basin outlets to 3" or 4" PVC and Corrugated Pipe
DBAA6	6" Basin Adapter	• Adapts 9", 12" & 18" Square Basin side outlets and 9" & 12" Low-Profile Basin outlets to 6" PVC and Corrugated Pipe
DPAFH34	Fitting Adapter	• Adapts 3" or 4" Triple Wall Pipe to 3" or 4" PVC and Corrugated Pipe
DBRE9	9" Square Basin Riser	• Extends height of 9" Square Basin or 9" Low-Profile Basin by 6"
DBRE12	12" Square Basin Riser	• Extends height of 12" Square Basin or 12" Low-Profile Basin by 6"

Flex Pipe

NEW

Ruggedly constructed and designed to work together, these drainage grates, basins, adapters, pipe, and accessories can help you efficiently manage water run-off for virtually any residential, light commercial or municipal site.

Solid Pipe Features

- Solid pipe is ideal for applications that involve diverting water from one point to another (i.e. away from downspouts). Does not allow water to seep in or out anywhere except pipe ends
- Available in 8', 12', 25' and 50' lengths
- Exceeds ASTM F-405 standards

Perforated Pipe Features

- A pipe with spaced slits, ideal for ground water drainage (French drains, dispersing water from flower beds) in applications where surrounding soil is coarse enough not to pose a clogging threat and/or surrounding debris is minimal
- Available in 8', 12', 25' and 50' lengths

Perforated with Sock Features

- A pipe with spaced slits, covered with removable polyester sock. Ideal for ground water drainage (French drains, dispersing water from flower beds) in applications where surrounding soil or sand is fine enough to require filtration and/or surrounding debris is considerable
- Available in 25' and 50' lengths

Model Number	Description	Width	Length
DFLXSOLID8	4 Inch Solid Flexible Drainage Pipe, From 2 Ft To 8 Ft	4"	8"
DFLXSOLID12	4 Inch Solid Flexible Drainage Pipe, From 3 Ft To 12 Ft	4"	12"
DFLXSOLID25	4 Inch Solid Flexible Drainage Pipe, Expands From 6 Ft To 25 Ft	4"	25"
DFLXSOLID50	4 Inch Solid Flexible Drainage Pipe, Expands From 12 Ft To 50 Ft	4"	50"
DFLXPERF8	4 Inch Perforated Flexible Drainage Pipe, Expands From 3 Ft To 8 Ft	4"	8"
DFLXPERF12	4 Inch Perforated Flexible Drainage Pipe, Expands From 3 Ft To 12 Ft	4"	12"
DFLXPERF25	4 Inch Perforated Flexible Drainage Pipe, Expands From 6 Ft To 25 Ft	4"	25"
DFLXPERF50	4 Inch Perforated Flexible Drainage Pipe, Expands From 12 Ft To 50 Ft	4"	50"
DFLXSOCK25	4 Inch Perforated Drainage Pipe With Filter Sock, Expands From 6 Ft To 25 Ft	4"	25"
DFLXSOCK50	4 Inch Perforated Drainage Pipe With Filter Sock, Expands From 12 Ft To 50 Ft	4"	50"



Rain Bird® Flexible Drain Pipe

Competition Corrugated Pipe



DFLXSOLID12

DFLXSOLID50



DFLXPERF8

DFLXPERF12



DFLXSOCK25

Flex Pipe Fittings and Accessories

Coupler

Female coupler is used to adapt flexible drainage pipe to other Rain Bird fittings, basins, channels, pop-ups, and 4" caps. It also connects the pipe to other standard 4" fittings to improve the fit and function of the overall system. Female coupler can also be used for joining 2 cut pieces of FLEXDrain together.

Connector

Expands up to 21" to connect 4" corrugated pipe, PVC and many other 4" pipes together. Creates any angle or turn, and expands to reach pipes that have been cut short, and is an excellent repair piece for damaged sections of pipe.

Model Number	Description	Width
DFLXCOUPL	Flexible Drainage Pipe Connector, Attaches Cut Pieces Of Flexible Pipe, And Connects Flexible Pipe To 4" Basins And Channel	4"
DFLXCONNECT	4 Inch Flexible Drainage Pipe Elbow Connector	4"
DFLXSPOU3X4	Downspout Adaptor, Fits 3X4 Downspout, Connects To 4" Flex Pipe, Pvc And Corrugated Pipe	4"
DFLXSPOU2X3	Downspout Adaptor, Fits 2X3 Downspout, Connects To 4" Flex Pipe, Pvc And Corrugated Pipe	4"
DFLXTYCON	4 Inch Flexible Tee. Wye Fitting, Connects Flexible Drainage Pipe, Pvc, And Corrugated Pipe	4"

Flexible Tee/Wye

Bends to any shape and connects multiple pieces of pipe including Flexible Drainage Pipe, 4" PVC, and 4" corrugated pipe. Allows you to the ability to create multiple angles. Couplers are required to connect the male end or cut end of flexible drain pipe to the fitting.



DFLXCOUPL



DFLXCONNECT



DFLXSPOU3X4



DFLXSOU2X3



DFLXTYCON

Rain Bird Series Channel Drainage

NEW

Rain Bird Engineered Channel Drain Systems are designed with the professional in mind. 5" wide systems with the accessories you need designed to save time and money.

Features

- Lattice Sidewall Anchors the Channel Drain into Concrete providing increased strength
- Less concrete required vs. competitor products
- Manufactured from structurally foamed High-Density Polyethylene (HDPE)
- UV stabilized recycled plastic to protect from sun degradation
- Snap-in design for grates that require no screws
- Ideal for sidewalks, driveways and patios
- Hold down feet to stop floatation during pouring of concrete
- Available in 1m lengths, plus a wide range of accessories

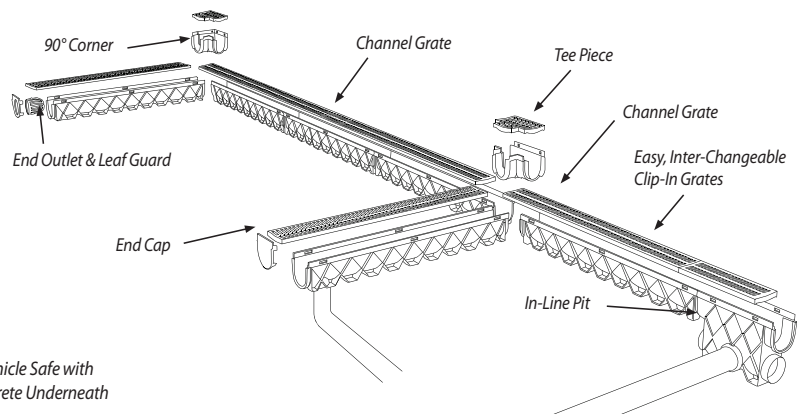
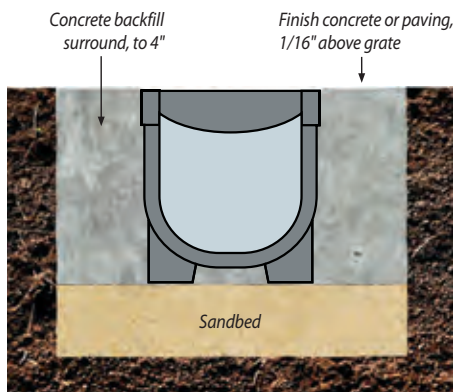

Channel Drains

NEW

Rain Bird **Low Profile 5" Channel Drain** is our in line drainage solution perfect for sidewalks, driveways and pool decks because it is lightweight, durable and UV stabilized. The hold down feet and pipe cut-outs make it simple to install.

Rain Bird **Standard 5" Channel Drain** is the complete professional drainage system designed for sidewalks, driveways, and patios, with corners and tee sections. With a complete range of accessories, and our no-screws clip-in grate design, our product is designed to make life easy. 5" Channel Drains are 5 ton vehicle safe.

Rain Bird **10" Industrial Drainage** is ideal for light commercial traffic or heavy, slow moving vehicles and has a complete range of accessories. 10 ton vehicle safe.

Model Number	Description	Width	Length
DCD1MX5SS	5" Standard Channel Drain, 1M Stainless Steel Grate	5"	40"
DCD1MX4B	5" Low Profile Straight Line Channel, 1M, Black Heel Guard	5"	40"
DCD1MX5G	5" Standard Channel Drain, 1M Gray Grate	5"	40"
DCD1MX5AR	5" Standard Channel Drain, 1M Architectural Grate	5"	40"
DCD1MX10ST	10" Industrial Grade Channel Drain, 1M Galvanized Steel Grate	10"	40"



DCD1MX5SS

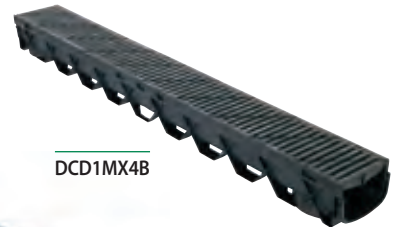

DCD1MX4B

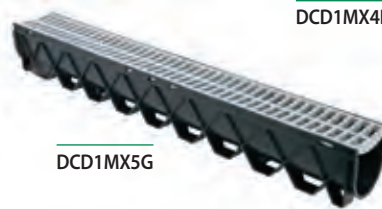

DCD1MX5G



DCD1MX5AR

Channel Drain In-Line Pits

NEW

- In-Line pit looks like an extension of the channel drain for a clean, uniform appearance
- In-Line pit has 4 outlet options
- Outlets allow for quick and easy gluing of 4" PVC pipe

Model Number	Description
DCDPIT5G	5" Standard Channel Drain Pit, Gray Grate
DCDPIT5SS	5" Standard Channel Drain Pit, Stainless Steel Grate
DCDPIT5AR	5" Standard Channel Drain Pit, Architectural Grate
DCDPIT10ST	10" Industrial Grade Drain Pit, Galvanized Steel Grate



DCDPIT5G



DCDPIT5SS



DCDPIT5AR

Drainage Products

Rain Bird Series Channel Drain Corners, Tees, End Caps, End Outlets and Leaf Guards

Channel Drain Corners and Tees

NEW

- Corners and Tees perfect for left or right extensions
- Designed to fit full length or cut channel drain sections
- Flexibility to change flow direction

Model Number	Description
DCDCOR5AR	5" Standard Channel Drain Corner, Architectural Grade
DCDCOR10ST	10" Industrial Grade Drain Corner, Galvanized Steel Grade



DCDCOR5AR

Channel Drain End Caps, End Outlets and Leaf Guards

NEW

- End caps can be sealed using silicone
- Use End Caps at the highest point of the Rain Bird Channel
- Use End Outlets at the low points of the Rain Bird Channel
- Connect to the low end of the channel or to the end of the In-Line Pit when using the bottom outlets

Model Number	Description
DCDENDOUT5	5" Standard Channel Drain Outlet
DCDENDCAP4	5" Low Profile Channel End Cap
DCDENDCAP5	5" Standard Channel Drain End Cap
DCDLEAFGD4	5" Low Profile Channel Drain Leaf Guard
DCDLEAFGD5	5" Standard Channel Drain Leaf Guard
DCDENDCAP10	10" Industrial Grade Channel Drain End Cap



DCDENDOUT5

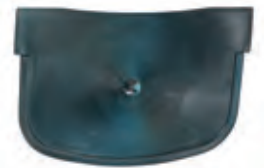

DCDENDCAP4



DCDENDCAP5



DCDENDCAP10



DCDLEAFGD4



DCDLEAFGD5

Drainage Pop-Up Valves

Features

- Available in four configurations
- Pop-up valve body manufactured from structurally foamed High-Density Polyethylene (HDPE)
- Elbow (where applicable) manufactured from PVC
- Adapter (where applicable) manufactured from High Impact Polystyrene (HIPS)
- UV stabilized to protect from sun degradation
- Spring-loaded cover rises ½" to discharge excess water in system
- Spring automatically retracts cover to closed position after excess water is discharged
- Can be used in both vertical and horizontal position
- Stainless steel spring to prevent rusting
- PVC elbows (where applicable) include a ¼" drain hole to eliminate standing water
- Made in the USA



Model Number	Color	Description	Connects To
DPUV3E	Green	Drainage Pop-Up Valve with 3" PVC Elbow	<ul style="list-style-type: none"> • 3" S & D Pipe (ASTM D2729) • 3" Triple Wall Pipe
DPUV4EHUB	Green	Drainage Pop-Up Valve with 4" PVC Elbow and Adapter (DPAFHA34)	<ul style="list-style-type: none"> • 3" or 4" Corrugated Pipe • 3" or 4" Triple Wall Pipe • 3" or 4" S & D Pipe (ASTM D2729)

Accessories

Soakwell

- High strength reinforced polymer
- Collects and reuses unwanted storm water runoff
- Drainage slots provide maximum water flow to surrounding soil
- 3 Piece design makes for easier installation and transport
- Strong but lightweight lid replaces concrete lid for easier installation

Model Number	Description	Color
DSOAKWELL	26.75" Diameter x 31.75" H Soakwell Base	6.61
DSOAKLID	26.75" Diameter Soakwell Lid	3.09
DSOAKSOCK	Soakwell Sock	0.22





Resources

Rain Bird Online Resources and Contacts List

Programs and Marketing Resources	Contacts/Information
Design and Specification Resources	www.rainbird.com/documents/professionals
Distributor Portal Website	www.rainbird.com/turfdistributor
Public and Non-Profit Agencies Portal	www.rainbird.com/agency
Facebook	www.facebook.com/RainBirdCorp
Intelligent Use of Water™	www.rainbird.com/corporate/intelligent-use-water
LEED Library	www.rainbird.com/LEED
Rain Bird Logo	www.rainbird.com/corporate/rain-bird-logo
Product Catalog	www.rainbird.com/catalog
Product Literature and Tech Specs	www.rainbird.com/documents/professionals
Rain Bird Agency Rewards (non-profits and government agencies)	www.rainbird.com/agency • E-mail: rewards@rainbird.com
Rain Bird Rewards	www.rainbird.com/Rewards • E-mail: rewards@rainbird.com
Rain Bird Training Services	www.rainbirdsolutions.com
Rain Bird Replacement Parts	www.rainbird.com/parts
Twitter	www.twitter.com/rainbirdcorp
Water Efficiency Calculators	www.rainbird.com/professionals/calculators
Site Reports	www.rainbird.com/sitereports
YouTube	www.youtube.com/rainbirdcorp

Rain Bird Training Services

Dedicated to the Development of Irrigation Professionals

Rain Bird Live and Online

Rain Bird Live Streaming

Rain Bird Brings the classroom to you

- Short pre-scheduled classes that cover relevant irrigation topics
- Make the most of your time and let Rain Bird bring training to you
- Live pre-scheduled training taught by professional irrigation trainers
- Not another sales webinar, we provide interactive virtual classroom training



Rain Bird Online Training

Rain Bird Basics Online

- For people with little to no irrigation experience
- Non-manufacturer specific training, not just Rain Bird
- The basics of irrigation adjustments, repairs and operation



Rain Bird Technical Online

- In-depth technical irrigation training anytime, anywhere
- Best practices for installing, operating, and maintaining irrigation systems
- Pass the Factory Trained exam and you will earn a Factory Trained designation and certificate



Rain Bird Classroom Training

Rain Bird Academy

General Irrigation Skills Training

- Top quality training on many manufacturers' products
- Prepare for Irrigation Association (IA) exams
- The Rain Bird Academy Boot Camp delivers the basics of irrigation in one week
 - Boot Camp classes are part of the IA Select Program



Rain Bird Factory Trained

Comprehensive Training on Rain Bird Products

- Training is exclusive to Rain Bird Products
- Be an expert on installing, managing and maintaining Rain Bird irrigation systems
- Get the designation that proves to your customers that you are the best choice to do the job



To learn more, visit: www.rainbirdsolutions.com

Rain Bird Rewards

Supporting Your Business Success and Growth

You're working hard to build a successful business and Rain Bird Rewards is here to reward you. We have the benefits and tools you can use to attract new customers, train your employees and reduce costs. Reinvesting in your company and its future success has never been so easy.

Join today — and get the benefits you need to take your business to the next level.

Help Your Business Succeed

Tools to grow your business.

- Use Rain Bird marketing materials to align your business with the industry leader

Rewards you deserve.

- Points can be redeemed to reward your hard work and help you build a successful business

Training discounts.

- Receive 20% off professional-level training from Rain Bird Training Services

Enroll today at ww2.rainbird.com/rewards/enrollment.htm



Reward for Your Hard Work

Let Rain Bird reward your growing business now and in the future.

Customer Service

At Rain Bird, we believe that when you purchase our products, you should also receive the support you need to ensure that they perform as designed. Like our products, Rain Bird customer service is designed to exceed expectations. When you call with questions about orders or new products, you get the support you need from the top water management professionals in the industry, backed by our vast global network of distributor-partners.

Worry-Free Warranties

Our comprehensive product warranties make it even easier to choose Rain Bird and relax. Most Rain Bird Landscape Irrigation products are warranted to the trade for a period of either three or five years from the date of original purchase. A Rain Bird warranty is hassle-free support that enables maximum peak performance by irrigation system professionals. For you, it's the added peace of mind of knowing Rain Bird is there when you need it.

Rain Bird's Professional Customer Satisfaction Policy

Rain Bird will repair or replace at no charge any Rain Bird professional product that fails in normal use within the warranty period stated below. You must return it to the dealer or distributor where you bought it. Product failures due to acts of God including without limitation, lightning and flooding, are not covered by this warranty. This commitment to repair or replace is our sole and total warranty.

Implied Warranties of Merchantability and Fitness, if Applicable, are Limited to One Year from the Date of Sale.

We will not, under any circumstances be liable for incidental or consequential damages, no matter how they occur.

I. Landscape Irrigation and Drainage Products

1800 Series Pop-Up Spray Heads, U-Series Nozzles, PA-8S and PA-8S-PRS Shrub Adapters, 1300 and 1400 Bubblers, 5000 Series Rotors, 5500 Series Rotors, 8005 Series Rotors, Falcon® 6504 Series Rotors, PEB/PESB/PESB-R Plastic Valves, DV/DVF and ASVF Plastic Valves, VB Series Valve Boxes, Internet Connected Water Meters (ICWM), and XF Series Dripline* – 5 years

C2 Power Unit – 2 years

Pump Start Relays – 1 year for controls/electronics, 2 years for enclosure

All other Landscape Irrigation and Drainage products – 3 years

II. Golf Products, Agricultural Products, and Pump Stations

For complete information and details please visit:

<http://www.rainbird.com/corporate/CustomerSatisfactionPolicy.htm>

III. All Other Products - 1 year

*XF Series Dripline - 7 Years on Environmental Stress Cracking (ESCR)

For more information, see your Rain Bird Distributor. To find the nearest authorized distributor in your area, visit www.rainbird.com or call 1-800-RAINBIRD

Controller Compatibility Matrix											
Accessory	Description	ESP9V	TBOSBT	ESPTM2	ESPME	ESPME3	ESPLXME	ESPLXMEF	ESPLXD	ESPLXIVM	ESPLXIVMP
Weather Sensors & Stations											
RSD-BEx	Wired Rain Sensor	●	●	●	●	●	●	●	●	●	●
WR2	Wireless Rain/Freeze Sensor			●	●	●	●	●	●	●	●
SMRT-Y	Soil Moisture Sensor			●	●	●					
ANEMOMETER	Wind Speed Sensor						● ¹	● ¹	● ¹	● ¹	● ¹
Flow Meters & Sensors											
MJ100B	1" Brass Water Meter					●		●	●	●	●
ICWM	Internet Connected Water Meter							●	●	●	●
FS100P	1" PVC Tee Flow Sensor					●		●	●	●	●
FS150P	1-1/2" PVC Tee Flow Sensor					●		●	●	●	●
FS200P	2" PVC Tee Flow Sensor					●		●	●	●	●
FS300P	3" PVC Tee Flow Sensor					●		●	●	●	●
FS400P	4" PVC Tee Flow Sensor					●		●	●	●	●
FS100B	1" Brass Tee Flow Sensor					●		●	●	●	●
FS150B	1-1/2" Brass Tee Flow Sensor					●		●	●	●	●
FS200B	2" Brass Tee Flow Sensor					●		●	●	●	●
FSINSERT	Replacement insert for tee sensors					●		●	●	●	●
FS350B	Insert Flow Sensor					●		●	●	●	●
Pulse Monitor/Transmitters											
PT322	Pulse Transmitter Flow										
PT5002	Flow Monitor/Pulse Transmitter Flow										
PT5002	Flow Monitor/Pulse Transmitter Wind						●	●	●	●	●
Sensor Decoders/Inputs											
SD210TURF	Sensor Decoder								●		
LXIVMSEN	IVM Sensor Input									●	●
Modules											
ESPSM3	ME 3-Station Module				●	●					
ESPSM6	ME 6-Station Module				●	●					
ESPLXMSM8	LXME 8-Station Module						●	●			
ESPLXMSM12	LXME 12-Station Module						●	●			
LXBASEMOD	LXME Base Module						●				
FSMLXME	LXME Flow Smart Module						●	●			
ESPLXD5M75	LXD 75-Station Module								●		
MOD50LXD	LXD 2-Wire Module								●		
LXIVM2WMOD	IVM 2-Wire Module									●	●
Field Decoders/Output Devices											
FD101TURF	1 Address, 1 Valve per Station Decoder								●		
FD102TURF	1 Address, 2 Valve per Station Decoder								●		
FD202TURF	2 Address, 2 Valve per Station Decoder								●		
FD401TURF	4 Address, 1 Valve per Station Decoder								●		
FD601TURF	1 Address, 1 Valve per Station Decoder								●		
DPU-210	FD-Series Decoder Programming Device								●		
LXIVMSOL	IVM Commercial Valve Solenoid									●	●
LXIVMOUT	IVM Output Device									●	●
Pump Start Relays											
PSR110220	110/220V Single Relay Pump Start Relay	●	●	●	●	●	●	●			
PSR1101C	110V Double Relay Pump Start Relay	●	●	●	●	●	●	●	●		
PSR2201C	220V Double Relay Pump Start Relay	●	●	●	●	●	●	●	●		
PSR110-IVM	110V DC Latching Pump Start Relay									●	●
PSR220-IVM	220V DC Latching Pump Start Relay									●	●
Surge Protection Devices											
LSP-1TURF	FD-Series Decoder Line Surge Protector								●		
LXIVMSD	IVM Surge Device									●	●
Communication Devices											
LNK-WIFI	Wi-Fi Module for Residential Controllers			●	●	●					
IQFSCMLXME	IQ Flow Smart Connection Module LXME						●	●			
IQCMLXD	IQ Connection Module LXD								●	●	●
IQ4G-USA	IQ 4G Cellular Communication Cartridge						●	●	●	●	●
IQNCCEN	IQ Ethernet Communication Cartridge						●	●	●	●	●
IQNCCRS	IQ RS232 Communication Cartridge						●	●	●	●	●
Radios											
IQSSRADIO	900MHz Radio, TCP-IP, Metal Case						●	●	●	●	●
RB-SS-TN9B	900MHz Radio, TCP-IP, Plastic Case						●	●	●	●	●
IQRADPK	900MHz Radio Programming Kit						●	●	●	●	●
Metal Cabinets & Pedestals											
LXMM	Painted Metal Wall Mount Enclosure						●	●	●	●	●
LXMMSS	Stainless Steel Wall Mount Enclosure						●	●	●	●	●
LXMPED	Painted Metal Pedestal (requires LXMM)						●	●	●	●	●
LXMMSSPED	Stainless Steel Pedestal (requires LXMMSS)						●	●	●	●	●

¹ Requires PT5002 Pulse Transmitter

Central Control Compatibility Matrix											
	ESPLXME	ESPLXMEF	IQ with ESPLXD	ESPLXIVM	ESPLXIVMP	Maxicom with ESPSITE	Maxicom CCU with ESPSAT2	ESPSATL	SiteControl TWI with ESPSAT2	ESPSATL	SiteControl with LDI
Weather Sensors & Stations											
RSD-BEx	Wired Rain Sensor	●	●	●	●	●	●	●	●	●	●
WR2	Wireless Rain/Freeze Sensor	●	●	●	●	●	●	●	●	●	●
RAINGAUGE	Tipping Rain Gauge Sensor	●	●	●	●	●	●	●	●	●	●
ANEMOMETER	Wind Speed Sensor	● ¹	● ¹	● ¹	● ¹	● ²	● ²	● ²	● ²	● ²	● ²
WSPRO2DC	Weather Station (requires modem)	●	●	●	●	●	●	●	●	●	●
Flow Meters & Sensors											
MJ100B	1" Brass Water Meter	●	●	●	●	● ²	● ²	● ²	● ²	● ²	●
ICWM	Internet Connected Water Meter	●	●	●	●	●	●	●	●	●	●
FS100P	1" PVC Tee Flow Sensor	●	●	●	●	● ²	● ²	● ²	● ²	● ²	●
FS150P	1-1/2" PVC Tee Flow Sensor	●	●	●	●	● ²	● ²	● ²	● ²	● ²	●
FS200P	2" PVC Tee Flow Sensor	●	●	●	●	● ²	● ²	● ²	● ²	● ²	●
FS300P	3" PVC Tee Flow Sensor	●	●	●	●	● ²	● ²	● ²	● ²	● ²	●
FS400P	4" PVC Tee Flow Sensor	●	●	●	●	● ²	● ²	● ²	● ²	● ²	●
FS100B	1" Brass Tee Flow Sensor	●	●	●	●	● ²	● ²	● ²	● ²	● ²	●
FS150B	1-1/2" Brass Tee Flow Sensor	●	●	●	●	● ²	● ²	● ²	● ²	● ²	●
FS200B	2" Brass Tee Flow Sensor	●	●	●	●	● ²	● ²	● ²	● ²	● ²	●
FSINSERT	Replacement insert for tee sensors	●	●	●	●	● ²	● ²	● ²	● ²	● ²	●
FS350B	Insert Flow Sensor	●	●	●	●	● ²	● ²	● ²	● ²	● ²	●
Pulse Monitor/Transmitters											
PT322	Pulse Transmitter	●	●	●	●	●	● ¹	●	● ¹	●	●
PTS002	Flow Monitor/Pulse Transmitter	●	●	●	●	●	● ¹	●	● ¹	●	●
Sensor Decoders/Inputs											
SD210TURF	Sensor Decoder	●	●	●	●	●	●	●	●	●	●
LXIVMSEN	IVM Sensor Input	●	●	●	●	●	●	●	●	●	●
DECPULLR	Pulse Decoder	●	●	●	●	●	●	●	●	●	●
DECEENLR	Sensor Decoder	●	●	●	●	●	●	●	●	●	●
Modules											
ESPM3	ME 3-Station Module	●	●	●	●	●	●	●	●	●	●
ESPM6	ME 6-Station Module	●	●	●	●	●	●	●	●	●	●
ESPLXMSM8	LXME 8-Station Module	●	●	●	●	●	●	●	●	●	●
ESPLXMSM12	LXME 12-Station Module	●	●	●	●	●	●	●	●	●	●
LXBASEMOD	LXME Base Module	●	●	●	●	●	●	●	●	●	●
FSMLXME	LXME Flow Smart Module	●	●	●	●	●	●	●	●	●	●
ESPLXDSM75	LXD 75-Station Module	●	●	●	●	●	●	●	●	●	●
MOD50LXD	LXD 2-Wire Module	●	●	●	●	●	●	●	●	●	●
LXIVM2WMOD	IVM 2-Wire Module	●	●	●	●	●	●	●	●	●	●
Field Decoders/Output Devices											
FD101TURF	1 Address, 1 Valve per Station Decoder	●	●	●	●	●	●	●	●	●	●
FD102TURF	1 Address, 2 Valve per Station Decoder	●	●	●	●	●	●	●	●	●	●
FD202TURF	2 Address, 2 Valve per Station Decoder	●	●	●	●	●	●	●	●	●	●
FD401TURF	4 Address, 1 Valve per Station Decoder	●	●	●	●	●	●	●	●	●	●
FD601TURF	1 Address, 1 Valve per Station Decoder	●	●	●	●	●	●	●	●	●	●
DPU-210	FD-Series Decoder Programming Device	●	●	●	●	●	●	●	●	●	●
LXIVMSOL	IVM Commercial Valve Solenoid	●	●	●	●	●	●	●	●	●	●
LXIVMOUT	IVM Output Device	●	●	●	●	●	●	●	●	●	●
Pump Start Relays											
PSR110220	110/220V Single Relay Pump Start Relay	●	●	●	●	●	●	●	●	●	●
PSR1101C	110V Double Relay Pump Start Relay	●	●	●	●	●	●	●	●	●	●
PSR2201C	220V Double Relay Pump Start Relay	●	●	●	●	●	●	●	●	●	●
PSR110-IVM	110V DC Latching Pump Start Relay	●	●	●	●	●	●	●	●	●	●
PSR220-IVM	220V DC Latching Pump Start Relay	●	●	●	●	●	●	●	●	●	●
Surge Protection Devices											
FSSURGEKIT	FS-Series Flow Sensor Surge Protector	●	●	●	●	●	●	●	●	●	●
LSP-1TURF	FD-Series Decoder Line Surge Protector	●	●	●	●	●	●	●	●	●	●
LXIVMSD	IVM Surge Device	●	●	●	●	●	●	●	●	●	●
Communication Devices											
LNK-WIFI	Wi-Fi Module for Residential Controllers	●	●	●	●	●	●	●	●	●	●
PBC-LXD	ESPLXD Programming Backup Cartridge	●	●	●	●	●	●	●	●	●	●
IQFSCMLXME	IQ Flow Smart Connection Module LXME	●	●	●	●	●	●	●	●	●	●
IQGMLXD	IQ Connection Module LXD	●	●	●	●	●	●	●	●	●	●
IQ4G-USA	IQ 4G Cellular Communication Cartridge	●	●	●	●	●	●	●	●	●	●
IQNCCEN	IQ Ethernet Communication Cartridge	●	●	●	●	●	●	●	●	●	●
IQNCCRS	IQ RS232 Communication Cartridge	●	●	●	●	●	●	●	●	●	●
RBDS-MPX	Maxi Link Communication Multiplexer	●	●	●	●	●	●	●	●	●	●
RBDS-PME	Maxi Primary Ethernet Modem	●	●	●	●	●	●	●	●	●	●
RBDS-SEMET	Maxi Link Secondary Ethernet Modem	●	●	●	●	●	●	●	●	●	●
ESPMIBTW	Maxi Two-Wire Satellite Interface Board	●	●	●	●	●	●	●	●	●	●
ESPMIBLINK	Maxi Link Satellite Interface Board	●	●	●	●	●	●	●	●	●	●
ESPMIBSITE	Maxi Site Satellite Interface Board	●	●	●	●	●	●	●	●	●	●
Radios											
IQSSRADIO	900MHz Radio, TCP-IP, Metal Case	●	●	●	●	●	●	●	●	●	●
RB-SS-TM9B	900MHz Radio, TCP-IP, Plastic Case	●	●	●	●	●	●	●	●	●	●
RADTN9M1B	900MHz Radio, TCP-IP, Plastic Case	●	●	●	●	●	●	●	●	●	●
IQRADPK	900MHz Radio Programming Kit	●	●	●	●	●	●	●	●	●	●
Auxiliary Terminal Strips											
ESPSATOB24	Maxi 1-24 Station Terminal Strip	●	●	●	●	●	●	●	●	●	●
ESPSATOB40	Maxi 25-40 Station Terminal Strip	●	●	●	●	●	●	●	●	●	●
Metal Cabinets & Pedestals											
LXMM	Painted Metal Wall Mount Enclosure	●	●	●	●	●	●	●	●	●	●
LXMMSS	Stainless Steel Wall Mount Enclosure	●	●	●	●	●	●	●	●	●	●
LXMMPED	Painted Metal Pedestal (requires LXMM)	●	●	●	●	●	●	●	●	●	●
LXMMSSPED	Stainless Steel Pedestal (requires LXMMSS)	●	●	●	●	●	●	●	●	●	●

¹ Requires PTS002 Pulse Transmitter

² Requires PT322 or PTS002 Pulse Transmitter

³ Requires DEC-Series Decoder for Sensor Input

How to Use This Catalog

Precipitation Rates

Rain Bird has calculated for you the precipitation rates for our comprehensive lines of impacts, sprays, and rotors. These rates are an indication of the approximate rate at which water is being applied. The equations used to calculate the precipitation rates are as follows:

Square Spacing

U.S.: $PR = 96.3 \times \frac{gpm}{S \times S}$
Metric: $PR = 1000 \times \frac{m^3/h}{S \times S}$

Triangular Spacing

U.S.: $PR = 96.3 \times \frac{gpm}{S \times L}$
Metric: $PR = 1000 \times \frac{m^3/h}{S \times L}$

96.3 = Constant (inches/square foot/hour)

1000 = Constant (millimeter/square meter/hour)

gpm = Gallons per minute (applied to area by sprinklers)

m³/h = Cubic meters per hour (applied to area by sprinklers)

S = Spacing between sprinklers

L = Spacing between rows (S x 0.866)

Specification Information

The information in this catalog was accurate at the time of printing and may be used for proper specification of each product. For the most up-to-date information, go to the Rain Bird web site at www.rainbird.com.

ASABE Test Certification Statement

Rain Bird Corporation certifies that pressure, flow rate, and radius data for its products were determined and listed in accordance with ASABE/ICC 802-2014 or ASAE S398.1, Procedure for Sprinkler Testing and Performance Reporting, and are representative of performance of production sprinklers at the time of publication. Actual product performance may differ from the published specifications due to normal manufacturing variations and sample selection. All other specifications are solely the recommendations of Rain Bird Corporation.

Reference Charts

Information contained in this catalog is based upon generally accepted formulas, computations, and trade practices. Rain Bird Corporation, and its subsidiaries and affiliates, shall not be responsible or liable therefore if any problems, difficulties, or injuries should arise from or in connection with the use or application of this information, or if there is any error herein, typographical or otherwise.

Technical Support

Rain Bird Technical Support has the answers to your specific product and water-management questions. Call our toll-free Technical Service number, or for maximum convenience, access the Rain Bird web site. You'll get expert advice and the right solutions.

Technical Service

1-800-RAINBIRD
(1-800-724-6247)

Internet Address

www.rainbird.com

Pressure Loss Through Water Meters

Pressure Loss: psi
Nominal Size

Flow gpm	5/8"	3/4"	1"	1 1/2"	2"	3"	4"
1	0.2	0.1					
2	0.3	0.2					
3	0.4	0.3					
4	0.6	0.5	0.1				
5	0.9	0.6	0.2				
6	1.3	0.7	0.3				
7	1.8	0.8	0.4				
8	2.3	1.0	0.5				
9	3.0	1.3	0.6				
10	3.7	1.6	0.7				
11	4.4	1.9	0.8				
12	5.1	2.2	0.9				
13	6.1	2.6	1.0				
14	7.2	3.1	1.1				
15	8.3	3.6	1.2				
16	9.4	4.1	1.4	0.4			
17	10.7	4.6	1.6	0.5			
18	12.0	5.2	1.8	0.6			
19	13.4	5.8	2.0	0.7			
20	15.0	6.5	2.2	0.8			
22		7.9	2.8	1.0			
24		9.5	3.4	1.2			
26		11.2	4.0	1.4			
28		13.0	4.6	1.6			
30		15.0	5.3	1.8			
32			6.0	2.1	0.8		
34			6.9	2.4	0.9		
36			7.8	2.7	1.0		
38			8.7	3.0	1.2		
40			9.6	3.3	1.3		
42			10.6	3.6	1.4		
44			11.7	3.9	1.5		
46			12.8	4.2	1.6		
48			13.9	4.5	1.7		
50			15.0	4.9	1.9	0.7	
52				5.3	2.1		
54				5.7	2.2		
56				6.2	2.3		
58				6.7	2.5		
60				7.2	2.7		
65				8.3	3.2	1.1	
70				9.8	3.7	1.3	
75				11.2	4.3	1.5	
80				12.8	4.9	1.6	0.7
90				16.1	6.2	2.0	0.8
100				20.0	7.8	2.5	0.9
110					9.5	2.9	1.0
120					11.3	3.4	1.2
130					13.0	3.9	1.4
140					15.1	4.5	1.6
150					17.3	5.1	1.8
160					20.0	5.8	2.1
170						6.5	2.4
180						7.2	2.7
190						8.0	3.0
200						9.0	3.2
220						11.0	3.9
240						13.0	4.7
260						15.0	5.5
280						17.3	6.3
300						20.0	7.2
350							10.0
400							13.0
450							16.2
500							20.0

PVC Class 160 IPS Plastic Pipe

(1120, 1220) SDR 26 C=150

psi Loss per 100 Feet of Pipe (psi/100 ft.)

Sizes 1" through 6" Flow 1 through 600 gpm

Nominal Size	1"	1 1/4"	1 1/2"	2"	2 1/2"	3"	4"	6"								
Pipe OD	1.315	1.660	1.900	2.375	2.875	3.500	4.500	6.625								
Avg. ID	1.175	1.512	1.734	2.173	2.635	3.21	4.134	6.084								
Avg. Wall	0.070	0.074	0.083	0.101	0.120	0.145	0.183	0.271								
Tolerance	0.020	0.020	0.020	0.020	0.020	0.020	0.020	0.031								
Min. Wall	0.060	0.064	0.073	0.091	0.110	0.135	0.173	0.255								
Flow (gpm)	Velocity (ft/s)	Loss (psi)	Velocity (ft/s)	Loss (psi)	Velocity (ft/s)	Loss (psi)	Velocity (ft/s)	Loss (psi)	Velocity (ft/s)	Loss (psi)	Velocity (ft/s)	Loss (psi)	Velocity (ft/s)	Loss (psi)	Velocity (ft/s)	Loss (psi)
1	0.30	0.02	0.18	0.01	0.14	0.00	0.09	0.00	0.06	0.00	0.04	0.00	0.02	0.00	0.01	0.00
2	0.59	0.07	0.36	0.02	0.27	0.01	0.17	0.00	0.12	0.00	0.08	0.00	0.05	0.00	0.02	0.00
3	0.89	0.15	0.54	0.04	0.41	0.02	0.26	0.01	0.18	0.00	0.12	0.00	0.07	0.00	0.03	0.00
4	1.18	0.25	0.71	0.07	0.54	0.04	0.35	0.01	0.24	0.00	0.16	0.00	0.10	0.00	0.04	0.00
5	1.48	0.38	0.89	0.11	0.68	0.06	0.43	0.02	0.29	0.01	0.20	0.00	0.12	0.00	0.06	0.00
6	1.77	0.54	1.07	0.16	0.81	0.08	0.52	0.03	0.35	0.01	0.24	0.00	0.14	0.00	0.07	0.00
7	2.07	0.71	1.25	0.21	0.95	0.11	0.60	0.04	0.41	0.01	0.28	0.01	0.17	0.00	0.08	0.00
8	2.36	0.91	1.43	0.27	1.09	0.14	0.69	0.05	0.47	0.02	0.32	0.01	0.19	0.00	0.09	0.00
9	2.66	1.14	1.61	0.33	1.22	0.17	0.78	0.06	0.53	0.02	0.36	0.01	0.21	0.00	0.10	0.00
10	2.96	1.38	1.78	0.40	1.36	0.21	0.86	0.07	0.59	0.03	0.40	0.01	0.24	0.00	0.11	0.00
11	3.25	1.65	1.96	0.48	1.49	0.25	0.95	0.08	0.65	0.03	0.44	0.01	0.26	0.00	0.12	0.00
12	3.55	1.94	2.14	0.57	1.63	0.29	1.04	0.10	0.71	0.04	0.48	0.01	0.29	0.00	0.13	0.00
14	4.14	2.58	2.50	0.76	1.90	0.39	1.21	0.13	0.82	0.05	0.55	0.02	0.33	0.01	0.15	0.00
16	4.73	3.30	2.86	0.97	2.17	0.50	1.38	0.17	0.94	0.06	0.63	0.02	0.38	0.01	0.18	0.00
18	5.32	4.10	3.21	1.20	2.44	0.62	1.56	0.21	1.06	0.08	0.71	0.03	0.43	0.01	0.20	0.00
20	5.91	4.99	3.57	1.46	2.71	0.75	1.73	0.25	1.18	0.10	0.79	0.04	0.48	0.01	0.22	0.00
22	6.50	5.95	3.93	1.74	2.99	0.90	1.90	0.30	1.29	0.12	0.87	0.04	0.53	0.01	0.24	0.00
24	7.09	6.99	4.28	2.05	3.26	1.05	2.07	0.35	1.41	0.14	0.95	0.05	0.57	0.02	0.26	0.00
26	7.68	8.11	4.64	2.38	3.53	1.22	2.25	0.41	1.53	0.16	1.03	0.06	0.62	0.02	0.29	0.00
28	8.27	9.30	5.00	2.73	3.80	1.40	2.42	0.47	1.65	0.18	1.11	0.07	0.67	0.02	0.31	0.00
30	8.87	10.57	5.35	3.10	4.07	1.59	2.59	0.53	1.76	0.21	1.19	0.08	0.72	0.02	0.33	0.00
35	10.34	14.06	6.25	4.12	4.75	2.12	3.02	0.71	2.06	0.28	1.39	0.11	0.84	0.03	0.39	0.00
40	11.82	18.00	7.14	5.28	5.43	2.71	3.46	0.90	2.35	0.35	1.58	0.14	0.95	0.04	0.44	0.01
45	13.30	22.39	8.03	6.56	6.11	3.37	3.89	1.12	2.64	0.44	1.78	0.17	1.07	0.05	0.50	0.01
50	14.78	27.21	8.92	7.98	6.78	4.10	4.32	1.37	2.94	0.53	1.98	0.20	1.19	0.06	0.55	0.01
55			9.82	9.52	7.46	4.89	4.75	1.63	3.23	0.64	2.18	0.24	1.31	0.07	0.61	0.01
60			10.71	11.18	8.14	5.74	5.18	1.91	3.53	0.75	2.38	0.29	1.43	0.08	0.66	0.01
65			11.60	12.97	8.82	6.66	5.62	2.22	3.82	0.87	2.57	0.33	1.55	0.10	0.72	0.01
70			12.49	14.88	9.50	7.64	6.05	2.55	4.11	1.00	2.77	0.38	1.67	0.11	0.77	0.02
75			13.38	16.90	10.18	8.68	6.48	2.89	4.41	1.13	2.97	0.43	1.79	0.13	0.83	0.02
80			14.28	19.05	10.86	9.78	6.91	3.26	4.70	1.28	3.17	0.49	1.91	0.14	0.88	0.02
85					11.53	10.94	7.34	3.65	4.99	1.43	3.37	0.55	2.03	0.16	0.94	0.02
90					12.21	12.16	7.78	4.06	5.29	1.59	3.56	0.61	2.15	0.18	0.99	0.03
95					12.89	13.45	8.21	4.48	5.58	1.76	3.76	0.67	2.27	0.20	1.05	0.03
100					13.57	14.79	8.64	4.93	5.88	1.93	3.96	0.74	2.39	0.22	1.10	0.03
110					14.93	17.64	9.50	5.88	6.46	2.30	4.36	0.88	2.63	0.26	1.21	0.04
120							10.37	6.91	7.05	2.71	4.75	1.04	2.86	0.30	1.32	0.05
130							11.23	8.02	7.64	3.14	5.15	1.20	3.10	0.35	1.43	0.05
140							12.10	9.20	8.23	3.60	5.54	1.38	3.34	0.40	1.54	0.06
150							12.96	10.45	8.81	4.09	5.94	1.57	3.58	0.46	1.65	0.07
160							13.82	11.77	9.40	4.61	6.34	1.76	3.82	0.52	1.76	0.08
170							14.69	13.17	9.99	5.16	6.73	1.97	4.06	0.58	1.87	0.09
180									10.58	5.73	7.13	2.19	4.30	0.64	1.98	0.10
190									11.16	6.34	7.52	2.42	4.54	0.71	2.09	0.11
200									11.75	6.97	7.92	2.67	4.77	0.78	2.20	0.12
225									13.22	8.67	8.91	3.32	5.37	0.97	2.48	0.15
250									14.69	10.53	9.90	4.03	5.97	1.18	2.76	0.18
275											10.89	4.81	6.57	1.40	3.03	0.21
300											11.88	5.65	7.16	1.65	3.31	0.25
325											12.87	6.55	7.76	1.91	3.58	0.29
350											13.86	7.52	8.36	2.19	3.86	0.33
375											14.85	8.54	8.95	2.49	4.13	0.38
400													9.55	2.81	4.41	0.43
425													10.15	3.14	4.68	0.48
450													10.74	3.50	4.96	0.53
475													11.34	3.86	5.24	0.59
500													11.94	4.25	5.51	0.65
550													13.13	5.07	6.06	0.77
600													14.32	5.96	6.61	0.91

Note: Dark shaded area of chart indicates velocities over 5' per second. Use with caution

The velocity values were derived using the following equation $V = \frac{0.408 \times Q_{gpm}}{d^2}$

Table are based upon the following Hazen-Williams equation: $H_f = 0.2083 \times \left(\frac{100}{C}\right)^{1.852} \times \frac{Q^{1.852}}{D^{4.8655}}$ for change in psi per foot of elevation. Pressure loss for uphill elevation and pressure gain for downhill elevation changes.

PVC Class 200 IPS Plastic Pipe

(1120, 1220) SDR 21 C=150

psi Loss per 100 Feet of Pipe (psi/100 ft.)

Sizes 3/4" through 6" Flow 1 through 600 gpm

Nominal Size Pipe OD	3/4"	1"	1 1/4"	1 1/2"	2"	2 1/2"	3"	4"	6"	
Avg. ID	0.91	1.169	1.482	1.7	2.129	2.581	3.146	4.046	5.955	
Avg. Wall	0.070	0.073	0.089	0.100	0.123	0.147	0.177	0.227	0.335	
Tolerance	0.020	0.020	0.020	0.020	0.020	0.020	0.020	0.026	0.038	
Min. Wall	0.060	0.063	0.079	0.090	0.113	0.137	0.167	0.214	0.316	
Flow (gpm)	Velocity (ft/s)	Loss (psi)	Velocity (ft/s)	Loss (psi)	Velocity (ft/s)	Loss (psi)	Velocity (ft/s)	Loss (psi)	Velocity (ft/s)	Loss (psi)
1	0.49	0.07	0.30	0.02	0.19	0.01	0.14	0.00	0.09	0.00
2	0.99	0.24	0.60	0.07	0.37	0.02	0.28	0.01	0.18	0.00
3	1.48	0.52	0.90	0.15	0.56	0.05	0.42	0.02	0.27	0.01
4	1.97	0.88	1.19	0.26	0.74	0.08	0.56	0.04	0.36	0.01
5	2.46	1.33	1.49	0.39	0.93	0.12	0.71	0.06	0.45	0.02
6	2.96	1.86	1.79	0.55	1.11	0.17	0.85	0.09	0.54	0.03
7	3.45	2.47	2.09	0.73	1.30	0.23	0.99	0.12	0.63	0.04
8	3.94	3.17	2.39	0.94	1.49	0.30	1.13	0.15	0.72	0.05
9	4.43	3.94	2.69	1.17	1.67	0.37	1.27	0.19	0.81	0.06
10	4.93	4.79	2.99	1.42	1.86	0.45	1.41	0.23	0.90	0.08
11	5.42	5.72	3.28	1.69	2.04	0.53	1.55	0.27	0.99	0.09
12	5.91	6.71	3.58	1.98	2.23	0.63	1.69	0.32	1.08	0.11
14	6.90	8.93	4.18	2.64	2.60	0.83	1.98	0.43	1.26	0.14
16	7.88	11.44	4.78	3.38	2.97	1.07	2.26	0.55	1.44	0.18
18	8.87	14.23	5.37	4.21	3.34	1.33	2.54	0.68	1.62	0.23
20	9.85	17.29	5.97	5.11	3.72	1.61	2.82	0.83	1.80	0.28
22	10.84	20.63	6.57	6.10	4.09	1.92	3.11	0.99	1.98	0.33
24	11.82	24.24	7.17	7.17	4.46	2.26	3.39	1.16	2.16	0.39
26	12.81	28.11	7.76	8.31	4.83	2.62	3.67	1.34	2.34	0.45
28	13.80	32.25	8.36	9.53	5.20	3.01	3.95	1.54	2.52	0.52
30	14.78	36.64	8.96	10.83	5.57	3.41	4.24	1.75	2.70	0.59
35			10.45	14.41	6.50	4.54	4.94	2.33	3.15	0.78
40			11.94	18.45	7.43	5.82	5.65	2.98	3.60	1.00
45			13.44	22.95	8.36	7.24	6.35	3.71	4.05	1.24
50			14.93	27.90	9.29	8.79	7.06	4.51	4.50	1.51
55					10.22	10.49	7.76	5.38	4.95	1.80
60					11.15	12.33	8.47	6.32	5.40	2.11
65					12.07	14.30	9.18	7.33	5.85	2.45
70					13.00	16.40	9.88	8.41	6.30	2.81
75					13.93	18.63	10.59	9.56	6.75	3.20
80					14.86	21.00	11.29	10.77	7.20	3.60
85							12.00	12.05	7.65	4.03
90							12.71	13.40	8.10	4.48
95							13.41	14.81	8.55	4.95
100							14.12	16.28	9.00	5.45
110									9.90	6.50
120									10.80	7.63
130									11.70	8.85
140									12.60	10.16
150									13.50	11.54
160									14.40	13.01
170									10.41	5.70
180									11.02	6.34
190									11.64	7.01
200									12.25	7.71
225									13.78	9.58
250									15.31	11.65
275									10.31	4.45
300									11.34	5.30
325									12.37	6.23
350									13.40	7.23
375									14.43	8.29
400									9.35	2.77
425									9.97	3.12
450									10.59	3.49
475									11.22	3.88
500									11.84	4.29
550									12.46	4.72
600									13.71	5.63

Note: Dark shaded area of chart indicates velocities over 5' per second. Use with caution

The velocity values were derived using the following equation $V = \frac{0.408 \times Q_{gpm}}{d^2}$

Table are based upon the following Hazen-Williams equation: $H_f = 0.2083 \times \left(\frac{100}{C}\right)^{1.852} \times \frac{Q^{1.852}}{D^{4.8655}}$ for change in psi per foot of elevation. Pressure loss for uphill elevation and pressure gain for downhill elevation changes.

PVC Class 315 IPS Plastic Pipe

(1120, 1220) SDR 13.5 C=150

psi Loss per 100 Feet of Pipe (psi/100 ft.)

Sizes 1/2" through 6" Flow 1 through 600 gpm

Nominal Size	1/2"	3/4"	1"	1 1/4"	1 1/2"	2"	2 1/2"	3"	4"	6"		
Pipe OD	0.840	1.050	1.315	1.660	1.900	2.375	2.875	3.500	4.500	6.625		
Avg. ID	0.6960	0.8740	1.1010	1.3940	1.5980	2.0030	2.4230	2.9510	3.7940	5.5840		
Avg. Wall	0.072	0.088	0.107	0.133	0.151	0.186	0.226	0.275	0.353	0.521		
Tolerance	0.020	0.020	0.020	0.020	0.020	0.020	0.026	0.031	0.040	0.059		
Min. Wall	0.062	0.078	0.097	0.123	0.141	0.176	0.213	0.259	0.333	0.491		
Flow (gpm)	Velocity (ft/s)	Loss (psi)	Velocity (ft/s)	Loss (psi)	Velocity (ft/s)	Loss (psi)	Velocity (ft/s)	Loss (psi)	Velocity (ft/s)	Loss (psi)	Velocity (ft/s)	Loss (psi)
1	0.84	0.25	0.53	0.08	0.34	0.03	0.21	0.01	0.16	0.00	0.10	0.00
2	1.68	0.90	1.07	0.30	0.67	0.10	0.42	0.03	0.32	0.02	0.20	0.01
3	2.53	1.90	1.60	0.63	1.01	0.20	0.63	0.06	0.48	0.03	0.31	0.01
4	3.37	3.24	2.14	1.07	1.35	0.35	0.84	0.11	0.64	0.06	0.41	0.02
5	4.21	4.89	2.67	1.61	1.68	0.53	1.05	0.17	0.80	0.09	0.51	0.03
6	5.05	6.86	3.20	2.26	2.02	0.74	1.26	0.23	0.96	0.12	0.61	0.04
7	5.90	9.12	3.74	3.01	2.36	0.98	1.47	0.31	1.12	0.16	0.71	0.05
8	6.74	11.68	4.27	3.86	2.69	1.25	1.68	0.40	1.28	0.20	0.81	0.07
9	7.58	14.53	4.81	4.80	3.03	1.56	1.89	0.49	1.44	0.25	0.92	0.08
10	8.42	17.66	5.34	5.83	3.37	1.90	2.10	0.60	1.60	0.31	1.02	0.10
11	9.26	21.07	5.88	6.96	3.70	2.26	2.31	0.72	1.76	0.37	1.12	0.12
12	10.11	24.75	6.41	8.17	4.04	2.66	2.52	0.84	1.92	0.43	1.22	0.14
14	11.79	32.93	7.48	10.87	4.71	3.53	2.94	1.12	2.24	0.58	1.42	0.19
16	13.48	42.16	8.55	13.92	5.39	4.53	3.36	1.44	2.56	0.74	1.63	0.25
18	15.16	52.44	9.61	17.32	6.06	5.63	3.78	1.79	2.88	0.92	1.83	0.31
20			10.68	21.05	6.73	6.84	4.20	2.17	3.20	1.12	2.03	0.37
22			11.75	25.11	7.40	8.16	4.62	2.59	3.52	1.33	2.24	0.44
24			12.82	29.50	8.08	9.59	5.04	3.04	3.83	1.57	2.44	0.52
26			13.89	34.21	8.75	11.12	5.46	3.53	4.15	1.82	2.64	0.60
28			14.96	39.25	9.42	12.76	5.88	4.05	4.47	2.08	2.85	0.69
30			16.02	44.60	10.10	14.50	6.30	4.60	4.79	2.37	3.05	0.79
35					11.78	19.29	7.35	6.12	5.59	3.15	3.56	1.05
40					13.46	24.70	8.40	7.84	6.39	4.03	4.07	1.34
45					15.15	30.72	9.45	9.75	7.19	5.01	4.58	1.67
50					16.83	37.34	10.50	11.85	7.99	6.09	5.08	2.03
55							11.55	14.13	8.79	7.27	5.59	2.42
60							12.60	16.60	9.59	8.54	6.10	2.85
65							13.65	19.26	10.39	9.91	6.61	3.30
70							14.70	22.09	11.18	11.37	7.12	3.79
75							15.75	25.10	11.98	12.91	7.63	4.30
80							16.80	28.29	12.78	14.55	8.14	4.85
85									13.58	16.28	8.64	5.42
90									14.38	18.10	9.15	6.03
95									15.18	20.01	9.66	6.67
100									15.98	22.00	10.17	7.33
110											11.19	8.74
120											12.20	10.27
130											13.22	11.92
140											14.24	13.67
150											15.25	15.53
160											16.27	17.50
170											11.81	7.76
180											12.51	8.62
190											13.20	9.53
200											13.90	10.48
225											15.64	13.03
250											17.37	15.84
275											12.88	7.24
300											14.06	8.51
325											15.23	9.87
350											16.40	11.32
375											17.57	12.86
400											11.34	4.27
425											12.05	4.77
450											12.75	5.31
475											13.46	5.87
500											14.17	6.45
550											15.59	7.70
600											17.01	9.04

Note: Dark shaded area of chart indicates velocities over 5' per second. Use with caution

The velocity values were derived using the following equation $V = \frac{0.408 \times Q_{gpm}}{d^2}$

Table are based upon the following Hazen-Williams equation: $H_f = 0.2083 \times \left(\frac{100}{C}\right)^{1.852} \times \frac{Q^{1.852}}{D^{4.8655}}$ for change in psi per foot of elevation. Pressure loss for uphill elevation and pressure gain for downhill elevation changes.

PVC Schedule 40 IPS Plastic Pipe

(1120, 1220) C=150

psi Loss per 100 Feet of Pipe (psi/100 ft.)

Sizes 1/2" through 6" Flow 1 through 600 gpm

Nominal Size	1/2"	3/4"	1"	1 1/4"	1 1/2"	2"	2 1/2"	3"	4"	6"		
Pipe OD	0.840	1.050	1.315	1.660	1.900	2.375	2.875	3.500	4.500	6.625		
Avg. ID	0.602	0.804	1.029	1.36	1.59	2.047	2.445	3.042	3.998	6.031		
Avg. Wall	0.119	0.123	0.143	0.150	0.155	0.164	0.215	0.229	0.251	0.297		
Tolerance	0.020	0.020	0.020	0.020	0.020	0.020	0.024	0.026	0.028	0.034		
Min. Wall	0.109	0.113	0.133	0.140	0.145	0.154	0.203	0.216	0.237	0.280		
Flow (gpm)	Velocity (ft/s)	Loss (psi)	Velocity (ft/s)	Loss (psi)	Velocity (ft/s)	Loss (psi)	Velocity (ft/s)	Loss (psi)	Velocity (ft/s)	Loss (psi)	Velocity (ft/s)	Loss (psi)
1	1.13	0.50	0.63	0.12	0.39	0.04	0.22	0.01	0.16	0.00	0.10	0.00
2	2.25	1.82	1.26	0.44	0.77	0.13	0.44	0.03	0.32	0.02	0.19	0.00
3	3.38	3.85	1.89	0.94	1.16	0.28	0.66	0.07	0.48	0.03	0.29	0.01
4	4.50	6.55	2.52	1.60	1.54	0.48	0.88	0.12	0.65	0.06	0.39	0.02
5	5.63	9.91	3.16	2.42	1.93	0.73	1.10	0.19	0.81	0.09	0.49	0.03
6	6.75	13.89	3.79	3.40	2.31	1.02	1.32	0.26	0.97	0.12	0.58	0.04
7	7.88	18.48	4.42	4.52	2.70	1.36	1.54	0.35	1.13	0.16	0.68	0.05
8	9.01	23.66	5.05	5.79	3.08	1.74	1.76	0.45	1.29	0.21	0.78	0.06
9	10.13	29.43	5.68	7.20	3.47	2.17	1.99	0.56	1.45	0.26	0.88	0.08
10	11.26	35.77	6.31	8.75	3.85	2.63	2.21	0.68	1.61	0.32	0.97	0.09
11	12.38	42.68	6.94	10.44	4.24	3.14	2.43	0.81	1.78	0.38	1.07	0.11
12	13.51	50.14	7.57	12.27	4.62	3.69	2.65	0.95	1.94	0.44	1.17	0.13
14	15.76	66.71	8.84	16.32	5.39	4.91	3.09	1.26	2.26	0.59	1.36	0.17
16	18.01	85.42	10.10	20.90	6.17	6.29	3.53	1.62	2.58	0.76	1.56	0.22
18	20.26	106.24	11.36	25.99	6.94	7.82	3.97	2.01	2.90	0.94	1.75	0.28
20			12.62	31.59	7.71	9.51	4.41	2.45	3.23	1.14	1.95	0.33
22			13.89	37.69	8.48	11.35	4.85	2.92	3.55	1.37	2.14	0.40
24			15.15	44.28	9.25	13.33	5.29	3.43	3.87	1.60	2.34	0.47
26			16.41	51.36	10.02	15.46	5.74	3.98	4.20	1.86	2.53	0.54
28			17.67	58.91	10.79	17.73	6.18	4.56	4.52	2.13	2.73	0.62
30			18.94	66.94	11.56	20.15	6.62	5.19	4.84	2.42	2.92	0.71
35					13.49	26.81	7.72	6.90	5.65	3.23	3.41	0.94
40					15.41	34.33	8.82	8.84	6.46	4.13	3.89	1.21
45					17.34	42.70	9.93	10.99	7.26	5.14	4.38	1.50
50					19.27	51.90	11.03	13.36	8.07	6.25	4.87	1.83
55							12.13	15.94	8.88	7.45	5.36	2.18
60							13.24	18.72	9.68	8.75	5.84	2.56
65							14.34	21.72	10.49	10.15	6.33	2.97
70							15.44	24.91	11.30	11.65	6.82	3.41
75							16.54	28.31	12.10	13.23	7.30	3.87
80							17.65	31.90	12.91	14.91	7.79	4.36
85							18.75	35.69	13.72	16.69	8.28	4.88
90							19.85	39.67	14.52	18.55	8.76	5.43
95									15.33	20.50	9.25	6.00
100									16.14	22.55	9.74	6.59
110									17.75	26.90	10.71	7.87
120									19.37	31.60	11.68	9.24
130									12.66	10.72	8.87	4.52
140									13.63	12.30	9.55	5.18
150									14.61	13.97	10.24	5.89
160									15.58	15.75	10.92	6.63
170									16.55	17.62	11.60	7.42
180									17.53	19.58	12.28	8.25
190									18.50	21.65	12.97	9.12
200									19.47	23.80	13.65	10.03
225									15.36	12.47	9.92	4.31
250									17.06	15.16	11.02	5.24
275									18.77	18.09	12.12	6.25
300									13.23	7.34	7.66	1.94
325									14.33	8.51	8.30	2.25
350									15.43	9.76	8.93	2.58
375									16.53	11.09	9.57	2.93
400									17.64	12.50	10.21	3.31
425									18.74	13.99	10.85	3.70
450									19.84	15.55	11.49	4.11
475											12.12	4.55
500											12.76	5.00
550											14.04	5.97
600											15.32	7.01

Note: Dark shaded area of chart indicates velocities over 5' per second. Use with caution

The velocity values were derived using the following equation $V = \frac{0.408 \times Q_{gpm}}{d^2}$

Table are based upon the following Hazen-Williams equation: $H_f = 0.2083 \times \left(\frac{100}{C}\right)^{1.852} \times \frac{Q^{1.852}}{D^{4.8655}}$ for change in psi per foot of elevation. Pressure loss for uphill elevation and pressure gain for downhill elevation changes.

PVC Schedule 80 IPS Plastic Pipe

(1120, 1220) C=150

psi Loss per 100 Feet of Pipe (psi/100 ft.)

Sizes 1/2" through 6" Flow 1 through 600 gpm

Nominal Size	1/2"	3/4"	1"	1 1/4"	1 1/2"	2"	2 1/2"	3"	4"	6"		
Pipe OD	0.840	1.050	1.315	1.660	1.900	2.375	2.875	3.500	4.500	6.625		
Avg. ID	0.526	0.722	0.935	1.254	1.476	1.913	2.289	2.864	3.786	5.709		
Avg. Wall	0.157	0.164	0.190	0.203	0.212	0.231	0.293	0.318	0.357	0.458		
Tolerance	0.020	0.020	0.022	0.024	0.024	0.026	0.034	0.036	0.040	0.052		
Min. Wall	0.147	0.154	0.179	0.191	0.200	0.218	0.276	0.300	0.337	0.432		
Flow (gpm)	Velocity (ft/s)	Loss (psi)	Velocity (ft/s)	Loss (psi)	Velocity (ft/s)	Loss (psi)	Velocity (ft/s)	Loss (psi)	Velocity (ft/s)	Loss (psi)	Velocity (ft/s)	Loss (psi)
1	1.47	0.97	0.78	0.21	0.47	0.06	0.26	0.01	0.19	0.01	0.11	0.00
2	2.95	3.50	1.57	0.75	0.93	0.21	0.52	0.05	0.37	0.02	0.22	0.01
3	4.42	7.42	2.35	1.59	1.40	0.45	0.78	0.11	0.56	0.05	0.33	0.01
4	5.90	12.64	3.13	2.71	1.87	0.77	1.04	0.18	0.75	0.08	0.45	0.02
5	7.37	19.11	3.91	4.09	2.33	1.16	1.30	0.28	0.94	0.13	0.56	0.04
6	8.85	26.78	4.70	5.74	2.80	1.63	1.56	0.39	1.12	0.18	0.67	0.05
7	10.32	35.63	5.48	7.63	3.27	2.17	1.82	0.52	1.31	0.24	0.78	0.07
8	11.80	45.63	6.26	9.77	3.73	2.78	2.08	0.67	1.50	0.30	0.89	0.09
9	13.27	56.75	7.04	12.15	4.20	3.45	2.34	0.83	1.69	0.37	1.00	0.11
10	14.75	68.98	7.83	14.77	4.67	4.20	2.59	1.01	1.87	0.46	1.11	0.13
11			8.61	17.62	5.13	5.01	2.85	1.20	2.06	0.54	1.23	0.15
12			9.39	20.70	5.60	5.88	3.11	1.41	2.25	0.64	1.34	0.18
14			10.96	27.55	6.53	7.83	3.63	1.88	2.62	0.85	1.56	0.24
16			12.52	35.27	7.47	10.03	4.15	2.40	3.00	1.09	1.78	0.31
18			14.09	43.87	8.40	12.47	4.67	2.99	3.37	1.35	2.01	0.38
20			15.65	53.32	9.33	15.16	5.19	3.63	3.75	1.64	2.23	0.47
22					10.27	18.08	5.71	4.33	4.12	1.96	2.45	0.56
24					11.20	21.24	6.23	5.09	4.49	2.30	2.68	0.65
26					12.13	24.64	6.75	5.91	4.87	2.67	2.90	0.76
28					13.07	28.26	7.26	6.77	5.24	3.06	3.12	0.87
30					14.00	32.12	7.78	7.70	5.62	3.48	3.34	0.99
35					16.33	42.73	9.08	10.24	6.55	4.63	3.90	1.31
40							10.38	13.11	7.49	5.93	4.46	1.68
45							11.68	16.31	8.43	7.38	5.02	2.09
50							12.97	19.83	9.36	8.97	5.57	2.54
55							14.27	23.65	10.30	10.70	6.13	3.03
60							15.57	27.79	11.24	12.57	6.69	3.56
65									12.17	14.58	7.25	4.13
70									13.11	16.73	7.80	4.74
75									14.05	19.01	8.36	5.38
80									14.98	21.42	8.92	6.06
85									15.92	23.96	9.48	6.78
90									10.03	7.54	7.01	3.15
95									10.59	8.34	7.40	3.48
100									11.15	9.17	7.79	3.83
110									12.26	10.94	8.57	4.57
120									13.38	12.85	9.34	5.37
130									14.49	14.90	10.12	6.22
140									15.61	17.09	10.90	7.14
150									11.68	8.11	7.46	2.73
160									12.46	9.14	7.96	3.07
170									13.24	10.23	8.46	3.44
180									14.02	11.37	8.95	3.82
190									14.80	12.57	9.45	4.22
200									15.57	13.82	9.95	4.64
225									11.19	5.78	6.40	1.49
250									12.44	7.02	7.12	1.81
275									13.68	8.38	7.83	2.15
300									14.92	9.84	8.54	2.53
325									16.17	11.41	9.25	2.94
350											9.96	3.37
375											10.67	3.83
400											11.39	4.31
425											12.10	4.82
450											12.81	5.36
475											13.52	5.93
500											14.23	6.52
550											6.88	1.05
600											7.51	1.24

Note: Dark shaded area of chart indicates velocities over 5' per second. Use with caution

The velocity values were derived using the following equation $V = \frac{0.408 \times Q_{gpm}}{d^2}$

Table are based upon the following Hazen-Williams equation: $H_f = 0.2083 \times \left(\frac{100}{C}\right)^{1.852} \times \frac{Q^{1.852}}{D^{4.8655}}$ for change in psi per foot of elevation. Pressure loss for uphill elevation and pressure gain for downhill elevation changes.

Polyethylene (PE) SDR Pressure Rated Tube

(2306, 3206, 3306) SDR 7, 9, 11.5, 15 C=140

psi Loss per 100 Feet of Pipe (psi/100 ft.)

Sizes 1/2" through 4" Flow 1 through 600 gpm

Nominal Size Avg. I.D.	1/2" 0.622		3/4" 0.824		1" 1.049		1 1/4" 1.380		1 1/2" 1.610		2" 2.067		2 1/2" 2.469		3" 3.068		4" 4.026	
Flow (gpm)	Velocity (ft/s)	Loss (psi)	Velocity (ft/s)	Loss (psi)	Velocity (ft/s)	Loss (psi)	Velocity (ft/s)	Loss (psi)	Velocity (ft/s)	Loss (psi)	Velocity (ft/s)	Loss (psi)	Velocity (ft/s)	Loss (psi)	Velocity (ft/s)	Loss (psi)	Velocity (ft/s)	Loss (psi)
1	1.05	0.49	0.60	0.12	0.37	0.04	0.21	0.01	0.16	0.00	0.10	0.00	0.07	0.00	0.04	0.00	0.03	0.00
2	2.11	1.76	1.20	0.45	0.74	0.14	0.43	0.04	0.31	0.02	0.19	0.01	0.13	0.00	0.09	0.00	0.05	0.00
3	3.16	3.73	1.80	0.95	1.11	0.29	0.64	0.08	0.47	0.04	0.29	0.01	0.20	0.00	0.13	0.00	0.08	0.00
4	4.22	6.35	2.40	1.62	1.48	0.50	0.86	0.13	0.63	0.06	0.38	0.02	0.27	0.01	0.17	0.00	0.10	0.00
5	5.27	9.60	3.00	2.44	1.85	0.76	1.07	0.20	0.79	0.09	0.48	0.03	0.33	0.01	0.22	0.00	0.13	0.00
6	6.33	13.46	3.61	3.43	2.22	1.06	1.29	0.28	0.94	0.13	0.57	0.04	0.40	0.02	0.26	0.01	0.15	0.00
7	7.38	17.91	4.21	4.56	2.60	1.41	1.50	0.37	1.10	0.18	0.67	0.05	0.47	0.02	0.30	0.01	0.18	0.00
8	8.44	22.93	4.81	5.84	2.97	1.80	1.71	0.47	1.26	0.22	0.76	0.07	0.54	0.03	0.35	0.01	0.20	0.00
9	9.49	28.52	5.41	7.26	3.34	2.24	1.93	0.59	1.42	0.28	0.86	0.08	0.60	0.03	0.39	0.01	0.23	0.00
10	10.55	34.67	6.01	8.82	3.71	2.73	2.14	0.72	1.57	0.34	0.95	0.10	0.67	0.04	0.43	0.01	0.25	0.00
11			6.61	10.53	4.08	3.25	2.36	0.86	1.73	0.40	1.05	0.12	0.74	0.05	0.48	0.02	0.28	0.00
12			7.21	12.37	4.45	3.82	2.57	1.01	1.89	0.48	1.15	0.14	0.80	0.06	0.52	0.02	0.30	0.01
14			8.41	16.45	5.19	5.08	3.00	1.34	2.20	0.63	1.34	0.19	0.94	0.08	0.61	0.03	0.35	0.01
16			9.61	21.07	5.93	6.51	3.43	1.71	2.52	0.81	1.53	0.24	1.07	0.10	0.69	0.04	0.40	0.01
18			10.82	26.21	6.67	8.10	3.86	2.13	2.83	1.01	1.72	0.30	1.20	0.13	0.78	0.04	0.45	0.01
20			12.02	31.85	7.42	9.84	4.28	2.59	3.15	1.22	1.91	0.36	1.34	0.15	0.87	0.05	0.50	0.01
22					8.16	11.74	4.71	3.09	3.46	1.46	2.10	0.43	1.47	0.18	0.95	0.06	0.55	0.02
24					8.90	13.79	5.14	3.63	3.78	1.72	2.29	0.51	1.61	0.21	1.04	0.07	0.60	0.02
26					9.64	16.00	5.57	4.21	4.09	1.99	2.48	0.59	1.74	0.25	1.13	0.09	0.65	0.02
28					10.38	18.35	6.00	4.83	4.41	2.28	2.67	0.68	1.87	0.28	1.21	0.10	0.70	0.03
30					11.12	20.85	6.43	5.49	4.72	2.59	2.86	0.77	2.01	0.32	1.30	0.11	0.76	0.03
35					12.98	27.74	7.50	7.30	5.51	3.45	3.34	1.02	2.34	0.43	1.52	0.15	0.88	0.04
40							8.57	9.35	6.30	4.42	3.82	1.31	2.68	0.55	1.73	0.19	1.01	0.05
45							9.64	11.63	7.08	5.49	4.30	1.63	3.01	0.69	1.95	0.24	1.13	0.06
50							10.71	14.14	7.87	6.68	4.77	1.98	3.35	0.83	2.17	0.29	1.26	0.08
55							11.78	16.87	8.66	7.97	5.25	2.36	3.68	0.99	2.38	0.35	1.38	0.09
60							12.85	19.82	9.44	9.36	5.73	2.77	4.02	1.17	2.60	0.41	1.51	0.11
65									10.23	10.86	6.21	3.22	4.35	1.36	2.82	0.47	1.64	0.13
70									11.02	12.45	6.68	3.69	4.69	1.55	3.03	0.54	1.76	0.14
75									11.81	14.15	7.16	4.19	5.02	1.77	3.25	0.61	1.89	0.16
80									12.59	15.95	7.64	4.73	5.35	1.99	3.47	0.69	2.01	0.18
85									13.38	17.84	8.12	5.29	5.69	2.23	3.68	0.77	2.14	0.21
90											8.59	5.88	6.02	2.48	3.90	0.86	2.27	0.23
95											9.07	6.50	6.36	2.74	4.12	0.95	2.39	0.25
100											9.55	7.15	6.69	3.01	4.33	1.05	2.52	0.28
110											10.50	8.53	7.36	3.59	4.77	1.25	2.77	0.33
120											11.46	10.02	8.03	4.22	5.20	1.47	3.02	0.39
130											12.41	11.62	8.70	4.89	5.63	1.70	3.27	0.45
140											13.37	13.33	9.37	5.61	6.07	1.95	3.52	0.52
150													10.04	6.38	6.50	2.22	3.78	0.59
160													10.71	7.19	6.94	2.50	4.03	0.67
170													11.38	8.04	7.37	2.79	4.28	0.74
180													12.05	8.94	7.80	3.11	4.53	0.83
190													12.72	9.88	8.24	3.43	4.78	0.92
200													13.39	10.87	8.67	3.78	5.03	1.01
225															9.75	4.70	5.66	1.25
250															10.84	5.71	6.29	1.52
275															11.92	6.81	6.92	1.81
300															13.00	8.00	7.55	2.13
325															14.09	9.28	8.18	2.47
350																	8.81	2.84
375																	9.44	3.22
400																	10.07	3.63
425																	10.70	4.06
450																	11.33	4.52
475																	11.96	4.99
500																	12.59	5.49
550																	13.84	6.55
600																	15.10	7.70

Note: Dark shaded area of chart indicates velocities over 5' per second. Use with caution

The velocity values were derived using the following equation $V = \frac{0.408 \times Q_{gpm}}{d^2}$

Table are based upon the following Hazen-Williams equation: $H_f = 0.2083 \times \left(\frac{100}{C}\right)^{1.852} \times \frac{Q^{1.852}}{D^{4.8655}}$ for change in psi per foot of elevation. Pressure loss for uphill elevation and pressure gain for downhill elevation changes.

Schedule 40 Standard Steel Pipe

C=100

psi Loss per 100 Feet of Pipe (psi/100 ft.)

Sizes 1/2" through 6" Flow 1 through 600 gpm

Nominal Size	1/2"		3/4"		1"		1 1/4"		1 1/2"		2"		2 1/2"		3"		4"		6"	
Pipe OD	0.840		1.050		1.315		1.660		1.900		2.375		2.875		3.500		4.500		6.625	
Avg. ID	0.622		0.824		1.049		1.380		1.610		2.067		2.469		3.068		4.026		6.065	
Avg. Wall	0.109		0.113		0.133		0.140		0.145		0.154		0.203		0.216		0.237		0.280	
Flow (gpm)	Velocity (ft/s)	Loss (psi)	Velocity (ft/s)	Loss (psi)	Velocity (ft/s)	Loss (psi)	Velocity (ft/s)	Loss (psi)	Velocity (ft/s)	Loss (psi)	Velocity (ft/s)	Loss (psi)	Velocity (ft/s)	Loss (psi)	Velocity (ft/s)	Loss (psi)	Velocity (ft/s)	Loss (psi)	Velocity (ft/s)	Loss (psi)
1	1.05	0.91	0.60	0.23	0.37	0.07	0.21	0.02	0.16	0.01	0.10	0.00	0.07	0.00	0.04	0.00	0.03	0.00	0.01	0.00
2	2.11	3.28	1.20	0.84	0.74	0.26	0.43	0.07	0.31	0.03	0.19	0.01	0.13	0.00	0.09	0.00	0.05	0.00	0.02	0.00
3	3.16	6.95	1.80	1.77	1.11	0.55	0.64	0.14	0.47	0.07	0.29	0.02	0.20	0.01	0.13	0.00	0.08	0.00	0.03	0.00
4	4.22	11.85	2.40	3.02	1.48	0.93	0.86	0.25	0.63	0.12	0.38	0.03	0.27	0.01	0.17	0.01	0.10	0.00	0.04	0.00
5	5.27	17.91	3.00	4.56	1.85	1.41	1.07	0.37	0.79	0.18	0.48	0.05	0.33	0.02	0.22	0.01	0.13	0.00	0.06	0.00
6	6.33	25.10	3.61	6.39	2.22	1.97	1.29	0.52	0.94	0.25	0.57	0.07	0.40	0.03	0.26	0.01	0.15	0.00	0.07	0.00
7	7.38	33.40	4.21	8.50	2.60	2.63	1.50	0.69	1.10	0.33	0.67	0.10	0.47	0.04	0.30	0.01	0.18	0.00	0.08	0.00
8	8.44	42.77	4.81	10.88	2.97	3.36	1.71	0.89	1.26	0.42	0.76	0.12	0.54	0.05	0.35	0.02	0.20	0.00	0.09	0.00
9	9.49	53.19	5.41	13.54	3.34	4.18	1.93	1.10	1.42	0.52	0.86	0.15	0.60	0.06	0.39	0.02	0.23	0.01	0.10	0.00
10	10.55	64.65	6.01	16.45	3.71	5.08	2.14	1.34	1.57	0.63	0.95	0.19	0.67	0.08	0.43	0.03	0.25	0.01	0.11	0.00
11	11.60	77.14	6.61	19.63	4.08	6.06	2.36	1.60	1.73	0.75	1.05	0.22	0.74	0.09	0.48	0.03	0.28	0.01	0.12	0.00
12	12.65	90.62	7.21	23.06	4.45	7.12	2.57	1.88	1.89	0.89	1.15	0.26	0.80	0.11	0.52	0.04	0.30	0.01	0.13	0.00
14			8.41	30.68	5.19	9.48	3.00	2.50	2.20	1.18	1.34	0.35	0.94	0.15	0.61	0.05	0.35	0.01	0.16	0.00
16			9.61	39.29	5.93	12.14	3.43	3.20	2.52	1.51	1.53	0.45	1.07	0.19	0.69	0.07	0.40	0.02	0.18	0.00
18			10.82	48.87	6.67	15.10	3.86	3.97	2.83	1.88	1.72	0.56	1.20	0.23	0.78	0.08	0.45	0.02	0.20	0.00
20			12.02	59.40	7.42	18.35	4.28	4.83	3.15	2.28	1.91	0.68	1.34	0.28	0.87	0.10	0.50	0.03	0.22	0.00
22			13.22	70.87	8.16	21.89	4.71	5.76	3.46	2.72	2.10	0.81	1.47	0.34	0.95	0.12	0.55	0.03	0.24	0.00
24					8.90	25.72	5.14	6.77	3.78	3.20	2.29	0.95	1.61	0.40	1.04	0.14	0.60	0.04	0.27	0.01
26					9.64	29.83	5.57	7.85	4.09	3.71	2.48	1.10	1.74	0.46	1.13	0.16	0.65	0.04	0.29	0.01
28					10.38	34.22	6.00	9.01	4.41	4.25	2.67	1.26	1.87	0.53	1.21	0.18	0.70	0.05	0.31	0.01
30					11.12	38.88	6.43	10.24	4.72	4.83	2.86	1.43	2.01	0.60	1.30	0.21	0.76	0.06	0.33	0.01
35					12.98	51.72	7.50	13.62	5.51	6.43	3.34	1.91	2.34	0.80	1.52	0.28	0.88	0.07	0.39	0.01
40					8.57	17.44	6.30	8.24	3.82	2.44	2.68	1.03	2.68	1.03	1.73	0.36	1.01	0.10	0.44	0.01
45					9.64	21.69	7.08	10.25	4.30	3.04	3.01	1.28	1.95	0.44	1.13	0.12	1.13	0.12	0.50	0.02
50					10.71	26.36	7.87	12.45	4.77	3.69	3.35	1.55	2.17	0.54	1.26	0.14	1.26	0.14	0.55	0.02
55					11.78	31.45	8.66	14.86	5.25	4.40	3.68	1.85	2.38	0.64	1.38	0.17	1.38	0.17	0.61	0.02
60					12.85	36.95	9.44	17.45	5.73	5.17	4.02	2.18	2.60	0.76	1.51	0.20	1.51	0.20	0.67	0.03
65					13.93	42.86	10.23	20.24	6.21	6.00	4.35	2.53	2.82	0.88	1.64	0.23	1.64	0.23	0.72	0.03
70					11.02	23.22	6.68	8.88	4.69	2.90	3.03	1.01	1.76	0.27	1.76	0.27	0.78	0.04		
75					11.81	26.39	7.16	7.82	5.02	3.29	3.25	1.14	1.89	0.31	1.89	0.31	0.83	0.04		
80					12.59	29.74	7.64	8.82	5.35	3.71	3.47	1.29	2.01	0.34	2.01	0.34	0.89	0.05		
85							13.38	33.27	8.12	9.86	5.69	4.15	3.68	1.44	2.14	0.38	0.94	0.05		
90									8.59	10.96	6.02	4.62	3.90	1.60	2.27	0.43	1.00	0.06		
95									9.07	12.12	6.36	5.10	4.12	1.77	2.39	0.47	1.05	0.06		
100									9.55	13.33	6.69	5.61	4.33	1.95	2.52	0.52	1.11	0.07		
110									10.50	15.90	7.36	6.70	4.77	2.33	2.77	0.62	1.22	0.08		
120									11.46	18.68	8.03	7.87	5.20	2.73	3.02	0.73	1.33	0.10		
130									12.41	21.66	8.70	9.12	5.63	3.17	3.27	0.85	1.44	0.12		
140									13.37	24.85	9.37	10.47	6.07	3.64	3.52	0.97	1.55	0.13		
150											10.04	11.89	6.50	4.13	3.78	1.10	1.66	0.15		
160											10.71	13.40	6.94	4.66	4.03	1.24	1.77	0.17		
170											11.38	15.00	7.37	5.21	4.28	1.39	1.89	0.19		
180											12.05	16.67	7.80	5.79	4.53	1.54	2.00	0.21		
190											12.72	18.43	8.24	6.40	4.78	1.71	2.11	0.23		
200											13.39	20.26	8.67	7.04	5.03	1.88	2.22	0.26		
225													9.75	8.76	5.66	2.33	2.50	0.32		
250													10.84	10.64	6.29	2.84	2.77	0.39		
275													11.92	12.70	6.92	3.38	3.05	0.46		
300													13.00	14.92	7.55	3.98	3.33	0.54		
325															8.18	4.61	3.60	0.63		
350															8.81	5.29	3.88	0.72		
375															9.44	6.01	4.16	0.82		
400															10.07	6.77	4.44	0.92		
425															10.70	7.58	4.71	1.03		
450															11.33	8.43	4.99	1.15		
475															11.96	9.31	5.27	1.27		
500															12.59	10.24	5.55	1.39		
550																	6.10	1.66		
600																	6.66	1.95		

Note: Dark shaded area of chart indicates velocities over 7' per second. Use with caution

The velocity values were derived using the following equation $V = \frac{0.408 \times Q_{gpm}}{d^2}$

Table are based upon the following Hazen-Williams equation: $H_f = 0.2083 \times \left(\frac{100}{C}\right)^{1.852} \times \frac{Q^{1.852}}{D^{4.8655}}$ for change in psi per foot of elevation. Pressure loss for uphill elevation and pressure gain for downhill elevation changes.

Type K Copper Water Tube

C=140

psi Loss per 100 Feet of Tube (psi/100 ft.)

Sizes 1/2" through 3" Flow 1 through 600 gpm

Nominal Size	1/2"		5/8"		3/4"		1"		1 1/4"		1 1/2"		2"		2 1/2"		3"	
Pipe OD	0.625		0.750		0.875		1.125		1.375		1.625		2.125		2.625		3.125	
Avg. ID	0.5270		0.652		0.745		0.995		1.245		1.481		1.959		2.435		2.907	
Avg. Wall	0.049		0.049		0.065		0.065		0.065		0.072		0.083		0.095		0.109	
Flow (gpm)	Velocity (ft/s)	Loss (psi)	Velocity (ft/s)	Loss (psi)	Velocity (ft/s)	Loss (psi)	Velocity (ft/s)	Loss (psi)	Velocity (ft/s)	Loss (psi)	Velocity (ft/s)	Loss (psi)	Velocity (ft/s)	Loss (psi)	Velocity (ft/s)	Loss (psi)	Velocity (ft/s)	Loss (psi)
1	1.47	1.09	0.96	0.39	0.74	0.20	0.41	0.05	0.26	0.02	0.19	0.01	0.11	0.00	0.07	0.00	0.05	0.00
2	2.94	3.94	1.92	1.40	1.47	0.73	0.82	0.18	0.53	0.06	0.37	0.03	0.21	0.01	0.14	0.00	0.10	0.00
3	4.41	8.35	2.88	2.97	2.21	1.55	1.24	0.38	0.79	0.13	0.56	0.05	0.32	0.01	0.21	0.00	0.14	0.00
4	5.88	14.23	3.84	5.05	2.94	2.64	1.65	0.65	1.05	0.22	0.74	0.09	0.43	0.02	0.28	0.01	0.19	0.00
5	7.35	21.51	4.80	7.64	3.68	3.99	2.06	0.98	1.32	0.33	0.93	0.14	0.53	0.04	0.34	0.01	0.24	0.01
6	8.81	30.15	5.76	10.70	4.41	5.59	2.47	1.37	1.58	0.46	1.12	0.20	0.64	0.05	0.41	0.02	0.29	0.01
7	10.28	40.12	6.72	14.24	5.15	7.44	2.88	1.82	1.84	0.61	1.30	0.26	0.74	0.07	0.48	0.02	0.34	0.01
8	11.75	51.37	7.68	18.24	5.88	9.53	3.30	2.33	2.11	0.78	1.49	0.34	0.85	0.09	0.55	0.03	0.39	0.01
9	13.22	63.90	8.64	22.68	6.62	11.85	3.71	2.90	2.37	0.97	1.67	0.42	0.96	0.11	0.62	0.04	0.43	0.02
10	14.69	77.66	9.60	27.57	7.35	14.41	4.12	3.52	2.63	1.18	1.86	0.51	1.06	0.13	0.69	0.05	0.48	0.02
11			10.56	32.89	8.09	17.19	4.53	4.21	2.90	1.41	2.05	0.61	1.17	0.16	0.76	0.05	0.53	0.02
12			11.52	38.64	8.82	20.20	4.95	4.94	3.16	1.66	2.23	0.71	1.28	0.18	0.83	0.06	0.58	0.03
14			13.44	51.41	10.29	26.87	5.77	6.57	3.69	2.21	2.60	0.95	1.49	0.24	0.96	0.08	0.68	0.04
16			15.36	65.83	11.76	34.41	6.59	8.42	4.21	2.83	2.98	1.22	1.70	0.31	1.10	0.11	0.77	0.05
18			17.28	81.88	13.23	42.80	7.42	10.47	4.74	3.52	3.35	1.51	1.91	0.39	1.24	0.13	0.87	0.06
20					14.70	52.02	8.24	12.72	5.26	4.28	3.72	1.84	2.13	0.47	1.38	0.16	0.97	0.07
22					16.17	62.06	9.07	15.18	5.79	5.10	4.09	2.19	2.34	0.56	1.51	0.19	1.06	0.08
24					17.64	72.91	9.89	17.84	6.32	5.99	4.46	2.58	2.55	0.66	1.65	0.23	1.16	0.10
26							10.71	20.69	6.84	6.95	4.84	2.99	2.76	0.77	1.79	0.27	1.26	0.11
28							11.54	23.73	7.37	7.97	5.21	3.43	2.98	0.88	1.93	0.30	1.35	0.13
30							12.36	26.96	7.90	9.06	5.58	3.89	3.19	1.00	2.06	0.35	1.45	0.15
35							14.42	35.87	9.21	12.05	6.51	5.18	3.72	1.33	2.41	0.46	1.69	0.19
40							16.48	45.94	10.53	15.43	7.44	6.63	4.25	1.70	2.75	0.59	1.93	0.25
45									11.84	19.20	8.37	8.25	4.78	2.11	3.10	0.73	2.17	0.31
50									13.16	23.33	9.30	10.03	5.32	2.57	3.44	0.89	2.41	0.38
55									14.48	27.84	10.23	11.96	5.85	3.07	3.78	1.06	2.66	0.45
60									15.79	32.70	11.16	14.05	6.38	3.60	4.13	1.25	2.90	0.53
65									17.11	37.93	12.09	16.30	6.91	4.18	4.47	1.45	3.14	0.61
70									18.43	43.51	13.02	18.70	7.44	4.79	4.82	1.66	3.38	0.70
75											13.95	21.24	7.97	5.45	5.16	1.89	3.62	0.80
80											14.88	23.94	8.51	6.14	5.50	2.13	3.86	0.90
85											15.81	26.79	9.04	6.87	5.85	2.38	4.10	1.01
90											16.74	29.78	9.57	7.63	6.19	2.65	4.35	1.12
95											17.67	32.91	10.10	8.44	6.54	2.93	4.59	1.24
100											18.60	36.19	10.63	9.28	6.88	3.22	4.83	1.36
110													11.69	11.07	7.57	3.84	5.31	1.62
120													12.76	13.01	8.26	4.51	5.79	1.91
130													13.82	15.08	8.95	5.23	6.28	2.21
140													14.88	17.30	9.63	6.00	6.76	2.54
150													15.95	19.66	10.32	6.82	7.24	2.88
160													17.01	22.16	11.01	7.69	7.72	3.25
170													18.07	24.79	11.70	8.60	8.21	3.63
180															12.39	9.56	8.69	4.04
190															13.07	10.57	9.17	4.46
200															13.76	11.62	9.66	4.91
225															15.48	14.46	10.86	6.10
250															17.20	17.57	12.07	7.42
275															18.92	20.96	13.28	8.85
300																	14.48	10.40
325																	15.69	12.06
350																	16.90	13.84
375																	18.11	15.72
400																	19.31	17.72
425																		
450																		
475																		
500																		
550																		

Note: Dark shaded area of chart indicates velocities over 7' per second. Use with caution

The velocity values were derived using the following equation $V = \frac{0.408 \times Q_{gpm}}{d^2}$

Table are based upon the following Hazen-Williams equation: $H_f = 0.2083 \times \left(\frac{100}{C}\right)^{1.852} \times \frac{Q^{1.852}}{D^{4.8655}}$ for change in psi per foot of elevation. Pressure loss for uphill elevation and pressure gain for downhill elevation changes.

Index

¼" Barb Transfer Fittings	151	Galvanized Tie-Down Stake	151	Retrofit Pressure Regulators	163
¼" Landscape Dripline	150	"G-Series" Hydraulic Suction Scanning Screen Filter ...	176	Riser Stake-Threaded	130
¼" Self-Piercing Barb Connector	120	HDF Series	180	Rotor Tool	43
¼" Tubing Stake with Cap	129	HE-VAN Series Nozzles	21	Round Catch Basins	184
1" & 1½" High Flow Inline Pressure Regulators	165	Holdup Tool with Bubble Level	43	RSD-BEX	100
1.5" Inline Commercial Control Zone Kit	159	How to Use This Catalog	198	R-VAN Nozzles	16
6 Outlet Manifold - EMT-6Xeri	120	HV Series	64	RWS (Root Watering System)	132
10-32 Thread Adapter	130	Inline RBY Filter	161	SA Series	12
12" PolyFlex Riser	130	Internet Connected Water Meters (ICWM)	97	SB Series Spiral Barb Fittings	13
24 VAC Solenoid Valves Wire Sizing – 50Hz	77	IQ4 Central Control Software	105	SH Series	76
24 VAC Solenoid Valves Wire Sizing – 60Hz	78	IQ NCC Network Communication Cartridge	106	SiteControl	107
300-BPES Brass Valves	72	"I-Series" Hydraulic Suction Scanning Screen Filter	177	SiteControl Hardware	108
1300A-F	36	Landscape Drip System Overview	114	SMRT-Y Soil Moisture Sensor Kit	102
1400 Series	36	Large-Capacity Filters	166	Spray-to-Drip Retrofit Kit	167
1800°-EXT	10	LNK WiFi Module	86	Spread Spectrum Radio	112
1800° NP Cover	10	Locking Cover Key	76	SPX Series Swing Pipe	13
1800°-SAM, 1800°-PRS, 1800°-P45, 1800°-SAM-PRS, 1800°-SAM-P45 Series	8	Low Flow Control Zone Kits with Anti-Siphon Valve and PR Filter	155	SQ Series, Square Pattern Nozzles	124
1800° Series	7	Low Flow Control Zone Kits with PR Filter	154	Square Basin Kits	185
1800 PCS	10	Low Flow Valves	160	Square Catch Basins	184
1800 Xeri-Bubbler Adapter	130	Low Profile Pump Stations – LP Series	171	Square Low-Profile Basins	185
2045A Maxi-Paw™ and 2045-PJ Maxi-Bird™	54	Low to Medium Flow Pump Stations – D-Series	172	Subterranean Emitter Box	151
3500 Series	38	Main Irrigation Pump Stations	174	Suggested Applications	129
5000 Series	40	Maxicom® version 4.5	109	TBOS-BT	90
5000 Series MPR Nozzles	46	Maxicom® Hardware	110	Technical Support	198
8005 Series	51	Medium Flow Control Zone Kits with Anti-Siphon Valve and PR Filter	155	TSJ/TSJ-PRS Series	59
½" FPT x Barb Grey Transfer Fitting	120	Medium Flow Control Zone Kits with PR Filter	156	Tubing Cutter	151
Air/Vacuum Relief Valve Kit	147	Medium Flow Control Zone Kits with PR Filter	156	Tubing Goof Plug	151
Anemometer Wind Sensor	100	Medium Flow Pump Station	173	Twist Lock Fittings	144
ASVF Series	63	MPR Spray Nozzles	31	UNI-Spray™ Series	6
Basin Adapters and Accessories	187	Multi-Outlet Xeri-Bug™	120	Universal ¼" Tubing Stake	129
Centrifugal Sand Separator	179	Online Control Zone Kit Selection Guide	152	Universal Square Grates	186
Channel Drain Corners and Tees	191	PA	10	U-Series Nozzles	24
Channel Drain End Caps, End Outlets and Leaf Guards	191	PA-85-PRS & PA-85-P45	10	Valve Keys	76
Channel Drain In-Line Pits	190	PA-80	10	VAN Series Nozzles	27
Channel Drains	190	PBCLXD Programming Backup Cartridge for ESP-LXD ..	95	VB Series Valve Boxes	80
CLP Series	169	PC Diffuser Caps	123, 129	WC Series Wire Connector	73
Commercial Valve Wire Sizing Procedure	77, 78	PEB / PESB Series	67	Wide Flow Commercial Control Zone Kit with Pressure Regulating, Basket Filter	157
Controller Pedestals	95	PESB-R Series Valves	69	Wide Flow Commercial Control Zone Kit with Scrubber Valve & Pressure Regulating, Basket Filter	158
Control Zone Kits	153	PGA Series	65	Worry-Free Warranties	195
Control Zone Kit Selection Guide	152	Plastic Round Grates	187	WR2 Series Wireless Rain + Freeze Sensors	101
CS Series	179	Plastic Square Grates	186	WS-PRO Weather Stations	111
Customer Service	195	PolyFlex Riser and Adapter Assemblies	130	XBS - Black Stripe Tubing	149
Diffuser Bug Cap	129	PolyFlex Riser and Stake Assembly	130	XD Risers	131
Disc Filters	180	Pressure-Compensating Modules	36, 122	Xeri-Bird™ 8-Outlet Emission Device	121
DPU-210 Decoder Programming Unit	95	Pressure Regulating, and Quick-Check Pressure Regulating Basket Filters	164	Xeri-Bird™ 8-Outlet Emission Device	121
Drainage Pop-Up Valves	192	Pressure-Regulating Filter (RBY)	161	Xeri-Bubblers™	127
Drip System Operation Indicator	147	PRS-Dial	74	Xeri-Bug™ Emitters	118
DV / DVF Series	61	PSS Series Self-Cleaning Pump Suction Screen	178	Xeri-Bug™ with Check Valve	116
Easy Fit Compression Fitting System	146	Pump Manager with SmartPump™	174	Xeriman™ Tool	118
EFB-CP Series Brass Valves	71	Pump Start Relays	175	Xeri-Pop™ Micro-Spray	126
ESP-9V Series	89	Purple Valve Handle Assembly	76	Xeri-Sprays™ and Misters	128
ESP-LXD Decoder Controller	92	PVB Professional Series Valve Boxes	79	Xeri-Spray™ 360° True Spray	128
ESP-LXIVM and LXIVM Pro 2-Wire Controllers	83	QF Dripline Header	143	XFCV Dripline with Check Valve	137
ESP-LXME/F Controllers	91	Quick-Check Basket Filter	163	XFD On-Surface Dripline	135
ESP-ME3 and ESP-Me Series Controllers	88	Quick-Coupling Valves	75	XF Dripline Insert Fittings	145
ESP-TM2 Series Controller	87	Rain Bird® ACLP Series	170	XF Insertion Tool	147
Falcon® 6504 Series	48	Rain Bird Drainage Products	183	XFS-CV Dripline with Heavy-Duty Check Valve	141
FD-TURF Two-Wire Decoders	94	Rain Bird Filtration Controller	181	XF Series Blank Tubing	148
Flex Pipe	188	Rain Bird Rewards	195	XFS Sub-Surface Dripline with Copper Shield™ Technology	139
Flex Pipe Fittings and Accessories	189	Rain Bird Series Channel Drainage	189	XLR Series Water Jets	56
Flow-Indicating Basket Filter	162	Rain Bird Series Channel Drainage	189	XQ ¼" Distribution Tubing	150
Flow Meters and Sensors	98	Rain Bird Training Services	194	XT-700 Distribution Tubing	148
Flow Monitors / Pulse Transmitters	99	RD1800™ Series Spray Heads	9		

The Intelligent Use of Water.™

LEADERSHIP • EDUCATION • PARTNERSHIPS • PRODUCTS

At Rain Bird, we believe it is our responsibility to develop products and technologies that use water efficiently. Our commitment also extends to education, training and services for our industry and our communities.

The need to conserve water has never been greater. We want to do even more, and with your help, we can. Visit www.rainbird.com for more information about The Intelligent Use of Water.™



Rain Bird Corporation
6991 E. Southpoint Road
Tucson, AZ 85756
Phone: (520) 741-6100
Fax: (520) 741-6522

Rain Bird Technical Services
(800) RAINBIRD (1-800-724-6247)
(U.S. and Canada)

Rain Bird Corporation
970 West Sierra Madre Avenue
Azusa, CA 91702
Phone: (626) 812-3400
Fax: (626) 812-3411

www.rainbird.com

Rain Bird International, Inc.
1000 West Sierra Madre
Azusa, CA 91702
Phone: (626) 963-9311
Fax: (626) 852-7343