

IQ™ Network Communication Cartridge (IQ-NCC)

Installation and User Manual for the IQ™ Central Control System



Technical Support

For technical assistance contact:

Rain Bird IQ-Cloud Support at 1-800-254-0692
iqcloudsupport@rainbird.com

Or for users with a Rain Bird Global Support (GSP) Plan, contact:

U.S. and Canada
 1-866-477-9778
 gsp@rainbird.com

International
 1-520-434-6216
 gsp@rainbird.com

Europe
 +33 4 42 24 44 61
 EuropeGSP@rainbird.fr

Australia
 1800 225 512
 info@rainbird.com.au

For more information on IQ including Training Videos, go to
www.rainbird.com/iq

Hazardous Warnings

⚠ WARNING

Indicates a hazardous situation that, if not avoided, could result in death or serious injury.

⚠ CAUTION

Indicates a hazardous situation that, if not avoided, could result in minor or moderate injury.

NOTICE

Indicates information considered important, but not hazard-related (e.g., messages relating to property damage).

SAFETY INSTRUCTIONS

Specific safety-related instructions or procedures are described.

Symbols & User Operation

① NUMBERS define a series of steps for the user to follow in order to operate the controller.



NOTE: Notifies the user of important operating instructions related to controller functionality, installation or maintenance.



REPEAT: Indicates that a repetition of previous steps or actions may be required for further operation, or to complete a process.

Contents

- Introduction 5**
- Welcome to Rain Bird 5**
 - About This Manual..... 5
 - ESP-LX Series Controllers..... 5
- IQ™ Central Control System 5**
 - IQ™ Network Communication Cartridge 5
 - Types of IQ™ Satellite Controllers 6
 - Direct Satellite 6
 - Server Satellite..... 6
 - Client Satellite..... 6
- Products Covered in this Manual 6**
 - Figure 1 - IQ™ Network Communication Cartridge 7
- Installation 8**
 - IQ™ Network Communication Cartridge Components 8**
 - Network Communication Cartridge 8
 - IQ Port Cable or Antenna 8
 - Connection Module (CM) 8
 - Connection Module (CM) Port Cable..... 8
 - Radio Modem Cable 8
 - Configuration Options 8**
 - Figure 2 - Installation Overview 9

- Box Contents 10**
 - Figure 3 - Box Contents 11
- Cartridge Installation 12**
 - Access Controller Cabinet..... 12
 - Remove the Communication Cable Knock-out 13
 - Install an External Antenna for LXMM..... 14
 - Install the Cartridge..... 16
 - Figure 4 - Installation/ Cable Options 17
 - Complete Cable Connections 19
 - Internal Antenna Installation..... 22
- IQ-NCC Configuration 24**
 - Direct Satellite Setup Wizard 24
 - Server Satellite Setup Wizard..... 26
 - Client Satellite Setup Wizard..... 28
- NCC Configurator Software 29**
- Operation 30**
 - Controls and Indicators 30**
 - Reset Button 30
 - LED Indicators 30
 - Table 1 - IQ Port LED Indicators..... 31
 - Table 2 - CM Port LED Indicators 32
 - Table 3 - Radio Port LED Indicators 32

Status Menu 33

Direct Satellite Controllers.....33

Ethernet.....33

4G Cellular34

Server Satellite Controllers35

Ethernet.....35

4G.....36

Client Satellite Controllers37

IQNet Alarms Menu..... 38**Appendix..... 40****Connection Modules..... 40**

Connection Module Options.....40

Base Module.....40

Flow Smart Module.....40

IQ Connection Module.....41

IQ Flow Smart Connection Module.....41

Connection Module Installation42

Connect IQ-CM Grounding Wire44

SIM Card Installation 45**Regulatory Information..... 46**

EMC Requirements for the United States.....46

Introduction

Welcome to Rain Bird

Thank you for purchasing your new state-of-the-art Rain Bird IQ Network Communication Cartridge (IQ-NCC) for the IQ Central Control System. For more than seven decades, Rain Bird has led the irrigation industry in meeting all of your water management needs by providing the highest quality products and services available.

About This Manual

This manual is an addendum to ESP-LX Series Controller Installation & Operations Guides. The instructions in this manual guide you through installing an IQ-NCC Cartridge in an ESP-LX Controller (not included), connecting the communication cables or antenna, and configuring the cartridge for communication with the IQ computer or IQ Server Satellite Controller.

ESP-LX Series Controllers

Rain Bird ESP-LXME, ESP-LXMEF, ESP-LXD, ESP-LXIVM and ESP-LXIVM Pro controllers normally operate as stand-alone irrigation controllers, but can be upgraded to become field components of the IQ Central Control System with the installation of an IQ Network Communications Cartridge.

IQ™ Central Control System

The IQ Central Control System provides remote communication capability for programming and monitoring multiple ESP-LX Series Controllers from a computer, tablet, or smart phone.

IQ™ Network Communication Cartridge

The addition of an IQ Network Communication Cartridge (IQ-NCC) turns a new or existing ESP-LX Series Controllers into an IQ Satellite Controller.

Three types of Network Communication Cartridges are available to provide communication with the IQ Central Computer:

- IQNCCEN Ethernet Cartridge
- IQ4G-USA Cellular Cartridge
- IQNCCRS RS-232 Cartridge

Types of IQ™ Satellite Controllers

IQ Satellite Controllers are configured as either a Direct, Server, or Client Satellite. The differences and capabilities of each are listed below:

Direct Satellite

Direct Satellites communicate with the IQ-Cloud or IQ Central Computer through IQ-NCC Cellular or Ethernet connections. Direct Satellites do not communicate with other Satellites.

Server Satellite

Server Satellites communicate with the IQ-Cloud or IQ Central Computer through IQ-NCC Cellular or Ethernet connections. Communication with up to 255 Client Satellites over the IQNet is accomplished using a radio modem or a high-speed communication PE-Cable connection.

Client Satellite

Client Satellites communicate with the Server Satellite or to other Client Satellites over the IQNet using IQ radio modems or a high-speed PE-Cable communication connections.

Products Covered in this Manual

This manual describes the installation of the following Rain Bird IQ™ products:

- Ethernet Network Communication Cartridge (IQCCEN)
- 4G Cellular Network Communication Cartridge (IQ4G-USA and IQ4G)
- RS-232 Network Communication Cartridge (IQCCRS) primarily used for Client Satellites



NOTE: The IQ4G-USA cartridge comes with a SIM card and 1-year of 4G Cellular telemetry service. The IQ4G cartridge does not come a SIM card or 4G Cellular telemetry service and must be purchased separately. See the SIM Card Installation section in the Appendix for details.

See the IQ Spread Spectrum (SS) Radio Installation & Programming Guide



**Figure 1 - IQ™ Network Communication Cartridge
(IQ-NCC-4G shown)**

Installation

This section provides instructions for installing and configuring an IQ Network Communication Cartridge into an ESP-LXME, ESP-LXD or ESP-LXIVM controller.

IQ™ Network Communication Cartridge Components

Network Communication Cartridge

Three types of IQ-NCC cartridges are available to communicate with IQ-Cloud or the IQ Central Computer:

- IQNCCEN Ethernet Cartridge
- IQ4GUSA Cellular Cartridge
- IQNCCRS RS-232 Cartridge

IQ Port Cable or Antenna

The IQ Port cable or antenna provides communication with the IQ-Cloud or IQ Central Computer.

Connection Module (CM)

The Connection Module (CM) installed in your ESP-LX Controller allows high-speed PE-cable communication between Server and Client Satellites on the IQNet.

Connection Module (CM) Port Cable

The Connection Module (CM) Port Straight Cable provides the connection between the IQ-NCC Cartridge and the Connection Module.

Radio Modem Cable

A radio modem can also be connected to the IQ-NCC Cartridge using the Y Cable to provide wireless radio communication between Server and Client Satellites on the IQNet.

Configuration Options

Before beginning installation, the following configuration options need to be determined and/or identified:

- Type of Cartridge (EN, 4G or RS)
- Type of Satellite Controller (Direct, Server, Client)
- Type of communication with other satellites (wireless connection using a radio modem, wired connection using an IQNet PE Communication Cable, or none)
- Controller model (ESP-LXME, ESP-LXMEF, ESP-LXD, ESP-LXIVM and ESP-LXIVM Pro controllers)
- Type of connection to the IQ computer; Ethernet cable, cellular or antenna

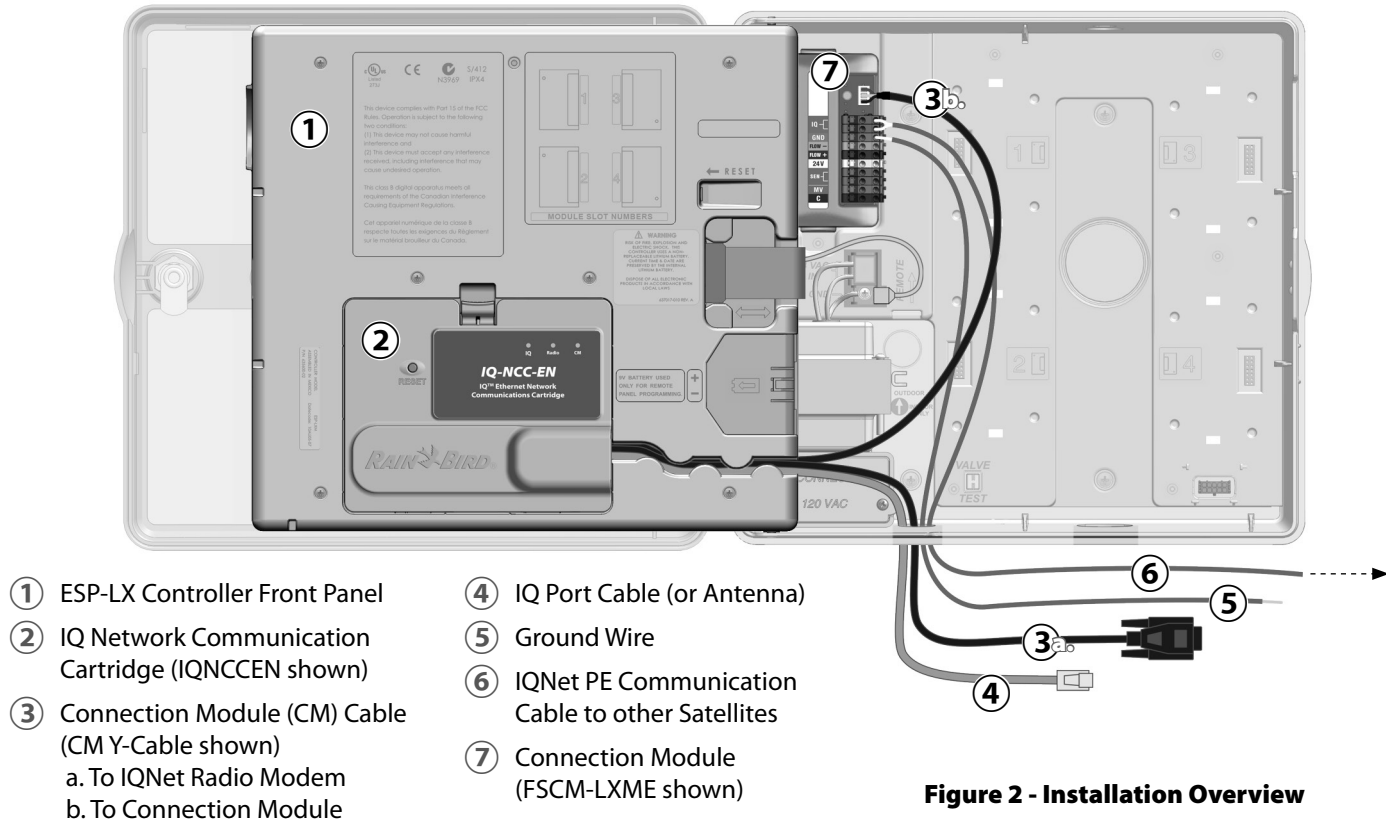

Figure 2 - Installation Overview

Box Contents

The following components are included with each IQ-NCC and are required for installation.



NOTE: If anything is missing, please contact your distributor before proceeding.

1. IQ Network Communication Cartridge
(ONE of the following):
 - IQNCCEN Ethernet Cartridge
 - IQ4G-USA Cellular Cartridge
 - IQNCCRS RS-232 Cartridge
2. Cartridge to Connection Module and/or Radio cables:
 - CM Y-Cable (IQ Radio and Connection Module)
 - CM Straight Cable (Connection Module)
3. IQ Communication Cables and Antennas
 - Ethernet Cable (IQNCCEN only)
 - Cellular Internal Antenna (IQ4G-USA and IQ4G only)
 - External Modem Cable (IQNCCRS only)
 - IQ Null Modem Cable (NCC Configurator Configuration)
4. Installation Manual & Quick Reference Guide

Connection Module (CM) Cables

CM Y-Cable (black)
Connects IQ-NCC Cartridge to IQ Radio.

IQ-NCCNMC Null-Modem (Serial) Cable
Used with Y-Cable, NCC Configurator Software, and computer to configure IQNCCEN Ethernet Cartridge

CM Straight Cable (black)
Connects IQ-NCC Cartridge to CM Connection Module

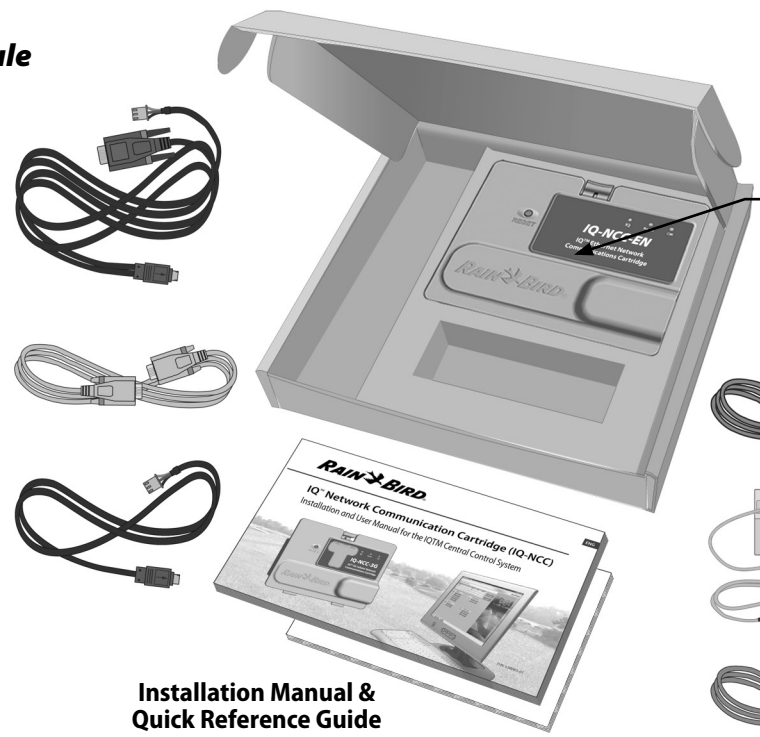

IQ Network Communication Cartridge (IQ-NCC)

IQ Port Cable Options

Ethernet Cable
Ships with IQNCCEN Ethernet Cartridge

Cellular Internal Antenna
Ships with IQ4G-USA and IQ4G Cellular Cartridge

External Modem Cable (beige)
Ships with IQNCCRS RS-232 Cartridge

Installation Manual & Quick Reference Guide

Figure 3 - Box Contents

Cartridge Installation

This section provides steps required to install an IQ-NCC and connect the required cables. The steps apply to all types of cartridges with any differences explained separately.

Access Controller Cabinet

- ① Unlock and open the outer door of the ESP-LX Series Controller.
- ② To open the controller front panel; grasp the crescent-shaped handle on the right-hand side of the front panel.

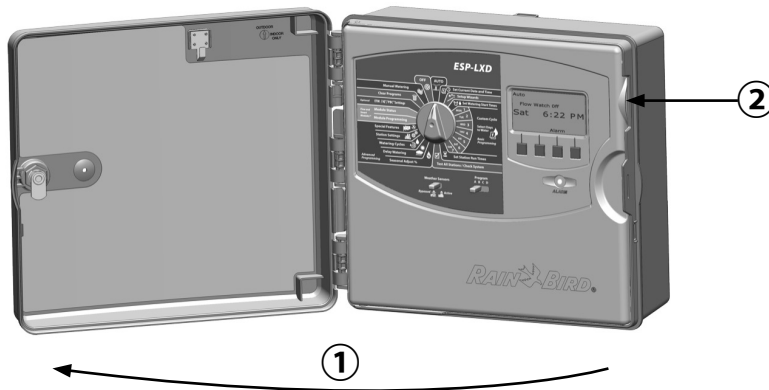

- ③ Pull the handle towards you and swing it to the left.

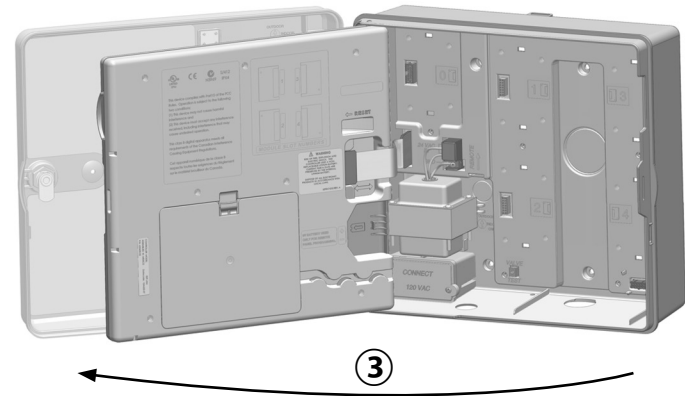

Remove the Communication Cable Knock-out

- ① Locate the IQ Port communication cable knock-out on the bottom left of the controller case, next to the transformer junction box.
- ② If a CM connection module will be installed for IQNet communication, locate the rear knock-out for the IQNet communication cable.
- ③ Using a screwdriver or other pointed tool; center the point of tool on the “dimple” in the center of the knock-out, then punch through and remove the cable knock-out(s).

⚠ CAUTION

Always wear eye protection when using tools or power equipment.

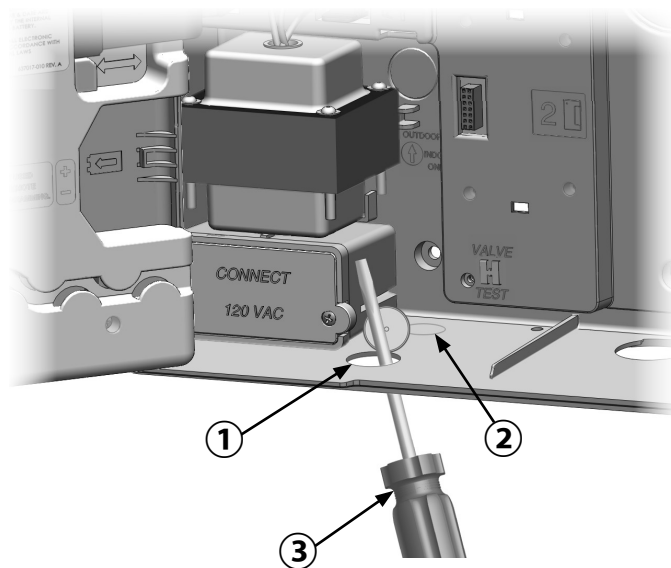

Install an External Antenna for LXMM

If the LXMM Metal Case is used along with the a IQ4G cartridge, then an external antenna must be installed in place of the internal antenna provided. These external antennas are not included with the NCC and must be purchased separately (part number IQEXTANTGP).

- ① Using a power drill and 5/8" (16 mm) drill bit, drill a hole through the "dimple" on the top right of the LXMM metal case.

⚠ CAUTION

Always wear eye protection when using tools or power equipment.

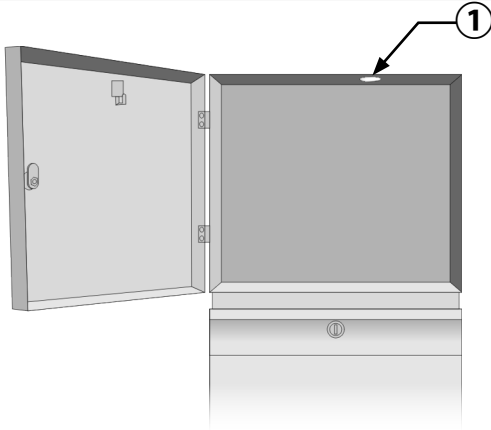

- ② Using a screwdriver or other pointed tool; center the point of tool on the "dimple" in the center of the knock-out, then punch through and remove the antenna knock-out hole located on the top right of the ESP-LX controller plastic case.

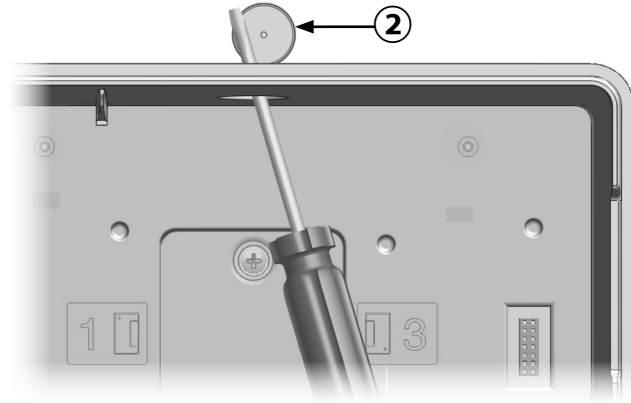

- ③ Follow the instructions which came with the LXMM to install the ESP-LX Series controller into the metal case.
- ④ Route the antenna cable through the knockouts on top of the metal case and the controller. Set the antenna into the hole and secure from the inside as shown, using the washers and nut provided.

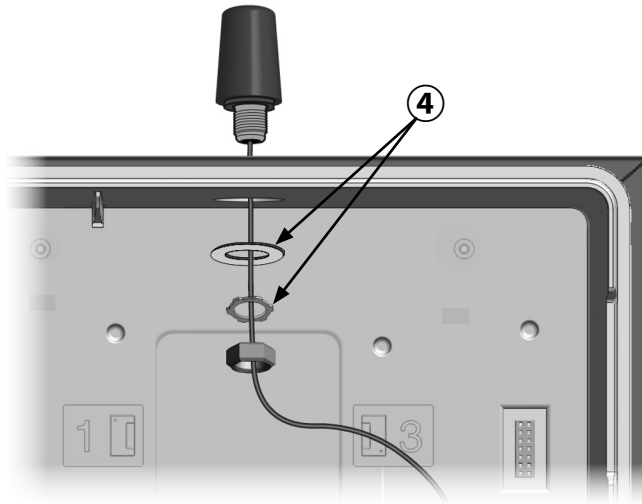

⚠ WARNING

To comply with FCC RF safety exposure limits, the antenna used for this transmitter must be installed to provide a separation distance of at least 20 cm from all persons and must not be located or operating in conjunction with any other antenna or transmitter.

Install the Cartridge

- 1 Press down on the top-latch of the cartridge bay cover and remove it from the back of the front panel.

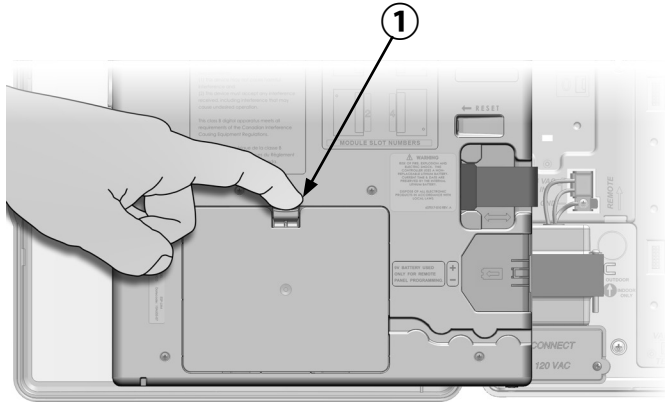

- 2 Connect the IQ Port cable or antenna to the cartridge (see Fig. 4). This cable or antenna provides the communication to the IQ computer.
- 3 Connect the CM Port cable to the cartridge that applies to the intended configuration (see Fig. 4). Two CM Port cables are included in the box with each cartridge, one straight cable and one Y-cable. The cable that is required depends on the controller configuration:

- If the satellite is a Server or Client that will use a radio modem for wireless communications with other satellites on the IQNet, then install the Y-cable. The Y-cable plugs directly into the radio modem (see user manual that comes with radio modem for installation and configuration instructions).
- If the satellite is a Server or Client that will use a wired connection (IQNet PE Communication Cable) to communicate with other satellites, install the straight cable.
- If the satellite is a Server or Client that will use a radio module for wireless communications AND a wired connection (IQNet PE Communication Cable) to communicate with other satellites, install the Y-cable.
- If the satellite is Direct (with no wireless or wired connection to another satellite) no CM Port cable is necessary.



NOTE: The Y-cable has a DB9 connector that will not fit through the knockout. Route the small end of the cable through the bottom of the knockout first, then connect to the CM Port.

CM Port Cables

CM Y-Cable (black)



CM Straight Cable (black)



IQ Port Cables

RJ-45 Ethernet Cable (green)



4G Cellular Internal Antenna (gold)



RS-232 External Modem Cable (beige)

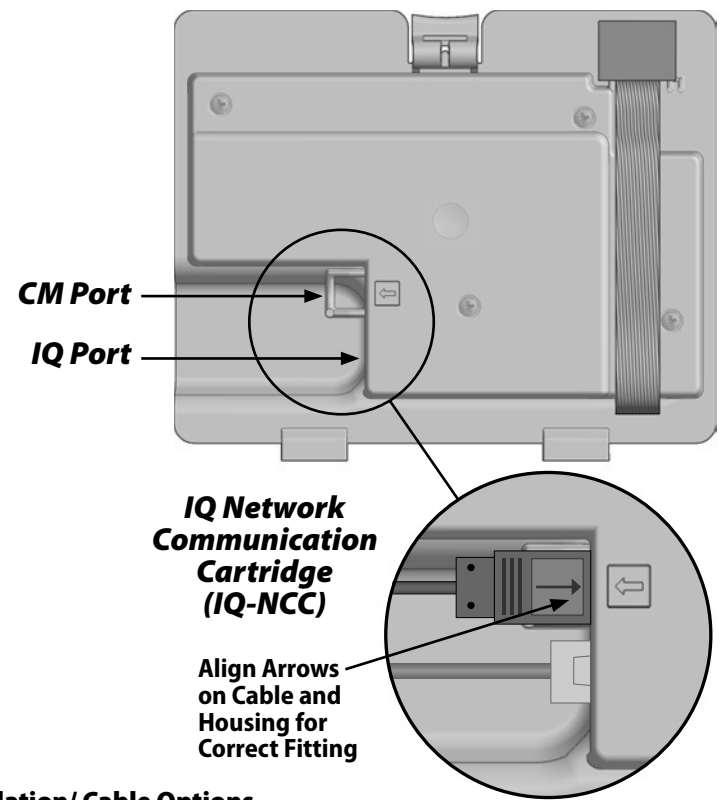

Figure 4 - Installation/ Cable Options



NOTE: The IQ4G cartridge requires a SIM card and 4G Cellular telemetry service account that is not provided and must be purchased separately. See the SIM Card Installation section in the Appendix for details.

- 4 Connect the cartridge ribbon cable to the card-edge connector located at the top left of the cartridge bay.

NOTICE

Ensure that the RED edge of the ribbon cable is towards the LEFT side of the connector.

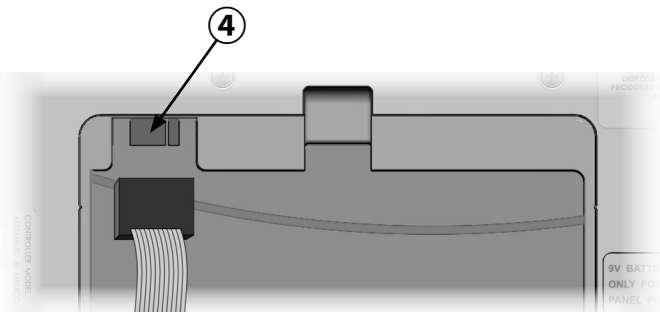

- 5 Orient the cartridge so that the two bottom hinges fit into the hinge openings at the bottom of the cartridge bay. Then gently swing the IQ-NCC up into place, snapping the top latch.

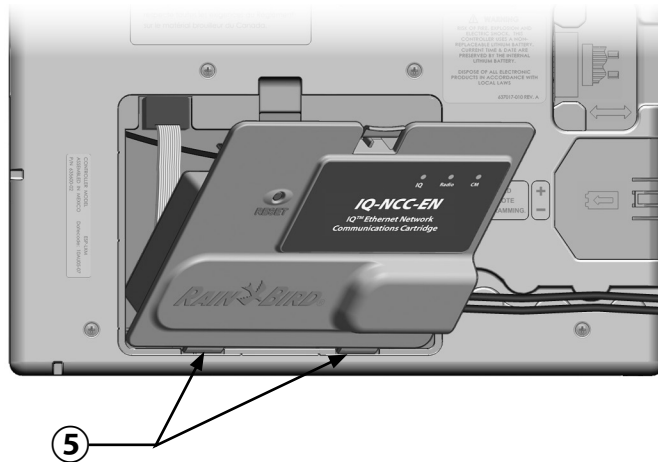

Complete Cable Connections

- ① Route all cables from the cartridge through the channel in back of the front panel.

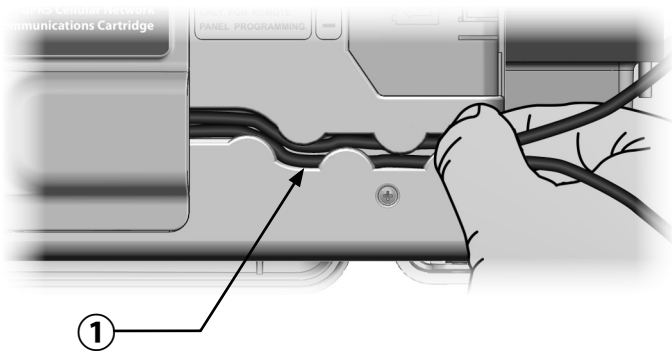

- ② For IQNCCEN Ethernet Cartridges, route the supplied RJ-45 Ethernet cable through the knockout in the lower left of the unit.

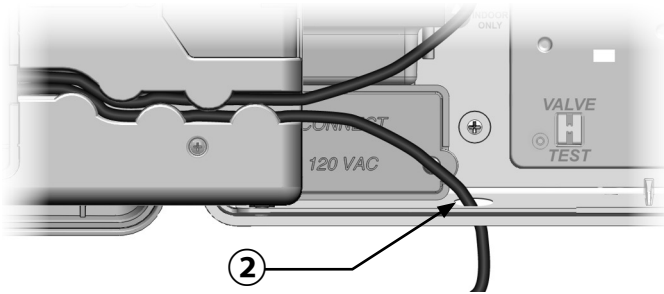

NOTICE

Do not plug a phone cable into the IQNCCEN Ethernet cartridge. This will damage the internal Ethernet modem.

- ③ If required, install the type of connection module in Slot 0 that is necessary for the intended configuration.



NOTE: If the satellite is being configured as a server or a client with a wired connection (IQNet PE Communication Cable) to another satellite, an IQ-FSCM-LXME (for the ESP-LXD, ESP-LXIVM or ESP-LXIVM Pro) connection module must be installed before proceeding. Refer to the Connection Modules section of the Appendix for details. If no wired connection is required, retain the base module that was shipped with the controller. (The ESP-LXD, ESP-LXIVM and ESP-LXIVM Pro controllers do not ship with a base module).

④

If a CM Port cable (Y-cable or straight) is installed, connect the keyed mating connector to the CM Connection Module as shown.



NOTE: The Y-cable may be used for a radio modem wireless connection only. If a connection module is not used, secure the unused cable end inside the satellite controller.

⑤

To establish a wired connection with another satellite, route one end of an IQNet PE Communication Cable through the knock-out on the bottom of the controller, and attach the conductors to the blue terminals on the CM Connection Module as shown.

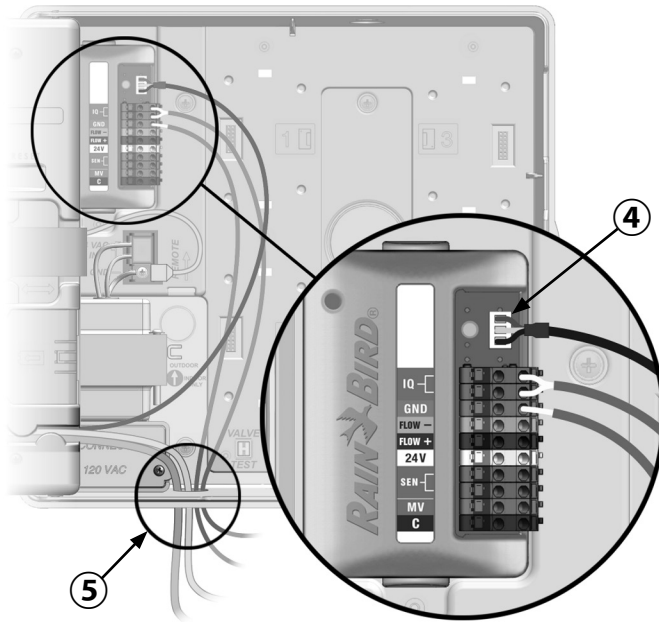

FSCM shown

- ⑥ Secure all cables inside the controller and close the front panel.

NOTICE

Ensure that all installed cables inside the satellite do not contact the transformer directly, as heat from the transformer may cause damage to a cable.

- ⑦ Connect the metal shield of the PE-Cable to the orange ground terminal (at one end of the PE-Cable only).

Internal Antenna Installation

IQ4G-USA and IQ4G Cellular Cartridges use the supplied internal antenna (if not using a metal enclosure). To install the internal antenna(s):

- ① Clean surface to remove any dust or dirt.
- ② Remove the adhesive backing cover strip from the 4G Cellular antenna.
- ③ Place antenna in close proximity to back-plane as shown, to allow ample clearance for the front panel to close without pinching the antenna cable.

⚠ WARNING

To comply with FCC RF safety exposure limits, the antenna used for this transmitter must be installed to provide a separation distance of at least 20 cm from all persons and must not be located or operating in conjunction with any other antenna or transmitter.

NOTICE

Take special care the first time when placing the antenna. Once installed it cannot be easily removed again.

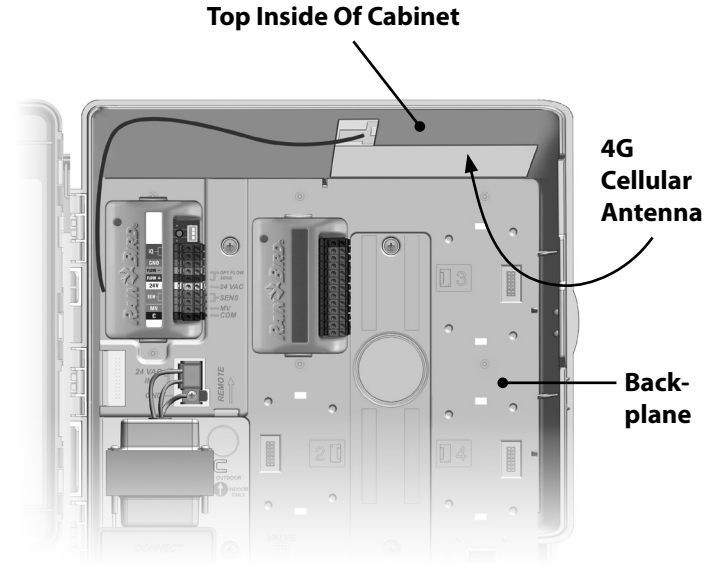

4G Cellular Internal Antenna Installation

This page intentionally left blank.

IQ-NCC Configuration

This section provides the steps required to configure an IQ-NCC for communication with the IQ computer.

Follow the same steps for each type of IQ-NCC, any differences are addressed in the specific step.

Direct Satellite Setup Wizard

Follow these steps to configure a Direct Satellite:

For LX-D and LXME:

- Turn the controller dial to ETM/IQ SETTINGS.

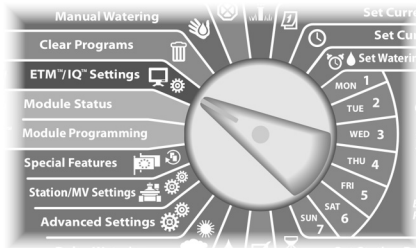

For LX-IVM:

- Turn the controller dial to Advanced Settings and choose Configure Cartridge.

- The IQ Settings main menu is displayed. Use the UP or DOWN arrows to select Setup Wizard; press Next.

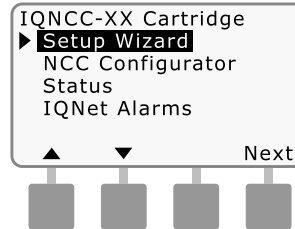

- The Setup - Satellite Type screen is displayed. Use + or - to select Direct; press Next.

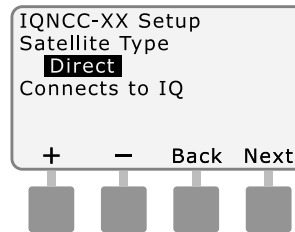

- The Setup – Satellite Address screen is displayed. Direct Satellites always have an address of 001; press Next.

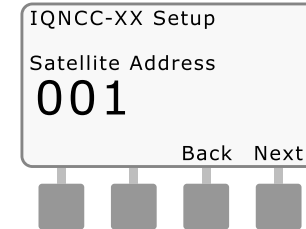

- The Setup – Satellite IQ Port screen is displayed; press Next.
 - For RS Only: use + or - to choose an IQ Port option, then press Next.

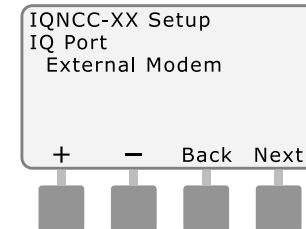



NOTE: The RS Cartridge has three options, External Modem and IQ Direct Connect, and IQSSRADIO. All other cartridges have only one option, either 4G/GPRS Cellular or Ethernet modem

- 5 The following message will be displayed. Press Dismiss to exit screen.

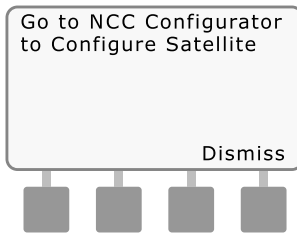

The Satellite is now ready to be configured by the NCC Configurator software (only required for IQNCC-EN Ethernet Cartridge configuration).

Server Satellite Setup Wizard

Follow these steps to configure a Server Satellite:

For LXJ and LXME:

- Turn the controller dial to ETM/IQ SETTINGS.

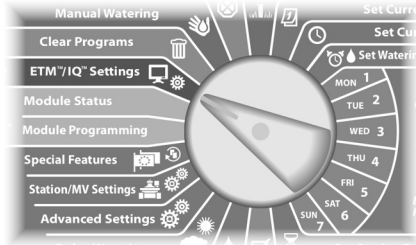

For LX-IVM:

- Turn the controller dial to Advanced Settings and choose Configure Cartridge.

- The IQ Settings main menu is displayed. Use the UP or DOWN arrows to select Setup Wizard; press Next.

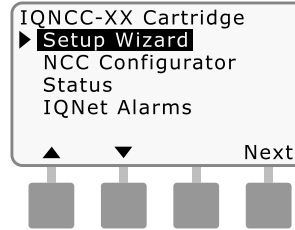

- The Setup - Satellite Type screen is displayed. Use + or - to select Server; press Next.

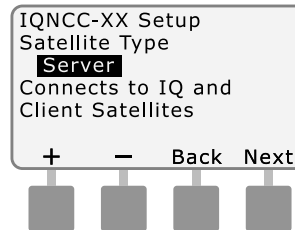

- The Setup - Satellite Address screen is displayed. Server Satellites always have an address of 001; press Next.

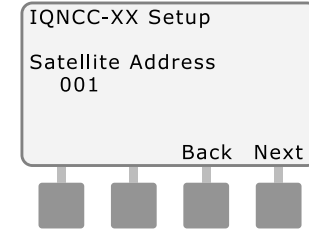

- The Setup - Satellite IQ Port screen is displayed; press Next.

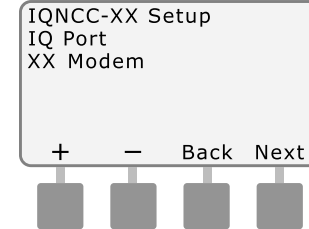



NOTE: Cartridges have only one option, either 4G/GPRS Cellular, or Ethernet, depending on the cartridge that is installed.

- 5 The Setup – Satellite Radio Port screen is displayed. Use + or - to select a radio port option (No Radio Installed, Radio Installed); press Next.

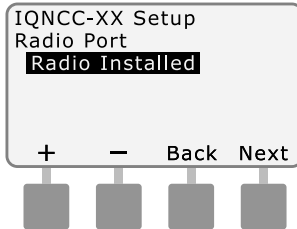

NOTE: If the Y-cable is installed for connection to a radio modem for wireless communication with other satellites, choose Radio Installed.

- 6 The Setup – Satellite CM Port screen is displayed. Use + or - to select a CM Port option (No Module Installed, Module Installed); press Next.

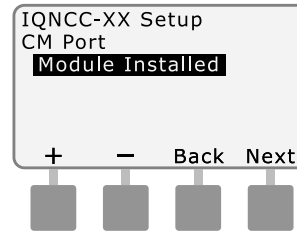

NOTE: If an IQ-FSCM-LXME or an IQ-CM-LXD connection module is installed for wired communications with other satellites, choose Module Installed.

- 7 The following message will be displayed. Press Dismiss to exit screen.

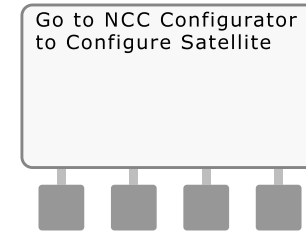

The Satellite is now ready to be configured by the IQ Software Configuration Utility.

Client Satellite Setup Wizard

Follow these steps to configure a controller as a Client Satellite:

For LXD and LXME:

- Turn the controller dial to ETM/IQ SETTINGS.

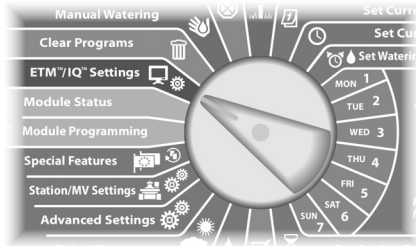

For LX-IVM:

- Turn the controller dial to Advanced Settings and choose Configure Cartridge.

- The IQ Settings main menu is displayed. Use the UP or DOWN arrows to select Setup Wizard; press Next.

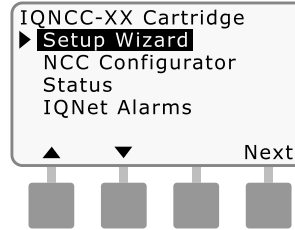

- The Setup - Satellite Type screen is displayed. Use + or - to select Client; press Next.

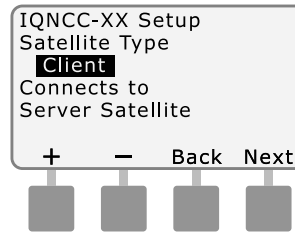

- The Setup - Satellite Address screen is displayed. Use + or - to select a unique address from 002-256 for this satellite (press and HOLD buttons to accelerate settings); press Next.

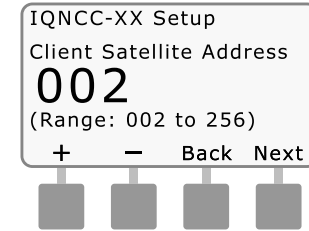

- The Setup - Satellite Radio Port screen is displayed. Use + or - to select a radio port option (No Radio Installed, Radio Installed); press Next.

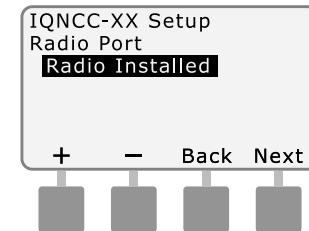



NOTE: If the Y-cable is installed for connection to a radio modem for wireless communication with the server, choose Radio Installed.

- 5 The Setup – Satellite CM Port screen is displayed. Use + or - to select a CM Port option (No Module, Module Installed); press Next.

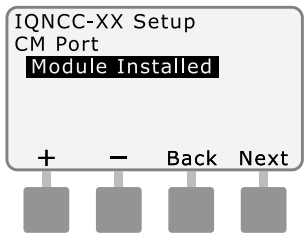

NOTE: If an IQ-FSCM-LXME or an IQ-CM-LXD connection module is installed for wired communications with other satellites, choose Module Installed.

- 6 The Setup – CM Port Termination screen is displayed. Use + or - to select a CM Port Termination option (On or Off).

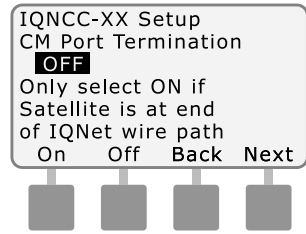

NOTE: CM Port termination is only required if this satellite is at the end of an IQNet PE Communication Cable path. If you are not sure, consult with the system designer.

NCC Configurator Software

The NCC Configurator Software is used to configure the network connections on the IQNCCEN Ethernet Cartridge. Consult the IQ-NCC Configurator Instructions for Help with configuration.

Operation

This section provides LED indications and front panel menu options that can be used to verify proper cartridge installation, operation, and configuration.

Controls and Indicators

Reset Button

The cartridge Reset button restarts the internal programming and re-enables communications with the IQ Central Computer without affecting configuration settings.

LED Indicators

The three LED lights on the front of each cartridge indicate the status of each communication port on any satellite controller. The meaning of each LED state is provided in the following tables.

Turn the ESP-LX Controller dial to IQ Settings and select Status for text version of the communication ports status.

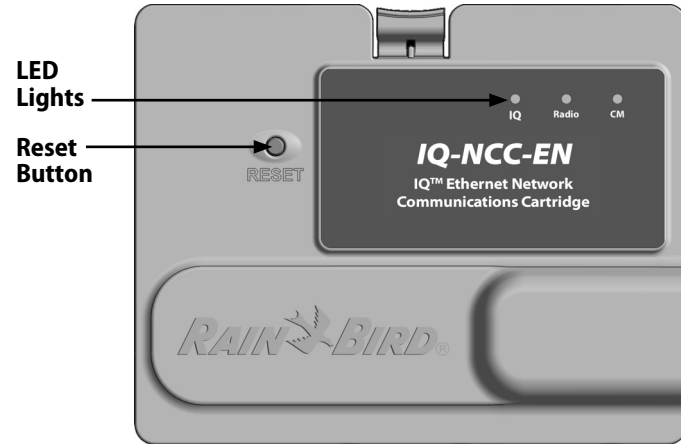

IQ Network Communication Cartridge (IQ-NCC-EN shown)

LED State	IQNCCEN Status	IQ4G Status	IQNCCRS Status
Dark	Port Disabled	Port Disabled	Port Disabled
Solid Red	Connected to active network (default IP address)	No SIM card installed	N/A
Blinking Red	No connection to cable/ switch	No RF signal from cell tower	No IQ computer connection/no radio modem detected
Solid Yellow	Connected to active network and has valid IP address, but not authenticated	Connected to cell tower	IQ computer connection/ radio modem detected, not connected to IQ
Blinking Yellow	Receiving data but not authenticated	Receiving data but not authenticated	Connecting with IQ but has not completed authentication
Solid green	Authenticated with IQ but no data is being sent/ received	Authenticated with IQ but no data is being sent/ received	Authenticated with IQ but no data is being sent/ received
Blinking green	Authenticated with IQ and data is being sent/received	Authenticated with IQ and data is being sent/received	Authenticated with IQ and data is being sent/received
Blinking Red/Yellow (sync all 3 LED's)	Reflash or Reset	Reflash or Reset	Reflash or Reset

Table 1 - IQ Port LED Indicators

LED State	Connection Module Status (CM or FSCM)
Dark	Port disabled (also dark if configured as Client or No Module Installed option selected in Setup Wizard)
Solid Red	N/A
Blinking Red	N/A
Solid Yellow	N/A
Blinking Yellow	Attempting to auto-BAUD or auto-polarity
Solid green	Valid BAUD and polarity, but no data is being sent/received
Blinking green	Data is being sent/received
Blinking Red/Yellow (sync all 3 LED's)	Reflash or Reset

Table 2 - CM Port LED Indicators



NOTE: The CM Port LED on Server Satellites and Client Satellites with both an IQNET Radio and CM Connection Module installed will continue to flash green as it searches for Client Satellites.

LED State	Radio Modem Status
Dark	Port disabled (also dark if configured as Client or No Radio Installed option selected in Setup Wizard)
Solid Red	N/A
Blinking Red	No radio modem detected
Solid Yellow	N/A
Blinking Yellow	N/A
Solid green	Radio modem detected, but no data is being sent/received
Blinking green	Radio modem detected, data is being sent/received
Blinking Red/Yellow (sync all 3 LED's)	Reflash or Reset

Table 3 - Radio Port LED Indicators



NOTE: The Radio Port LED on Server Satellites and Client Satellites with both an IQNET Radio and CM Connection Module installed will continue to flash green as it searches for Client Satellites.

Status Menu

The Status Menu is used to display the status of each communication port on the front panel LCD.

For Direct and Server Satellites with an IQ4G cartridge installed, the signal strength between the IQ computer and the controller can be displayed.

Server Satellites can use the Ping feature to verify communication with any user-selected Client Satellite.

Direct Satellite Controllers

Ethernet

To display the status of Direct Satellites IQNCCEN cartridge installed:

For LXJ and LXME:

- ② Turn the controller dial to ETM/IQ SETTINGS.

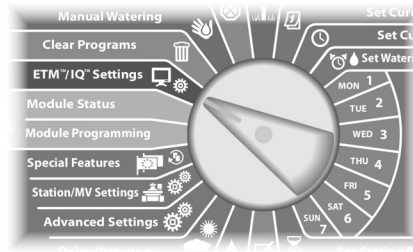

For LX-IVM:

- ② Turn the controller dial to Advanced Settings and choose Configure Cartridge.

- ① The IQ Settings main menu is displayed. Use the UP or DOWN arrows to select Status; press Next.

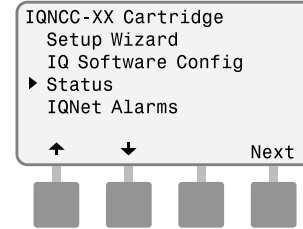

- ② The Satellite Status screen is displayed. Current status of IQ, Radio, and CM ports are shown.

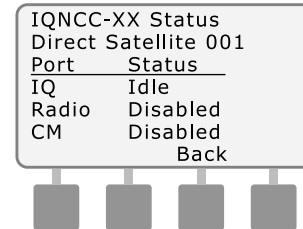

Direct Satellite Controllers

4G Cellular

To display the status of Direct Satellites with IQ4G cartridge installed:

For LXJ and LXME:

- Turn the controller dial to ETM/IQ SETTINGS.

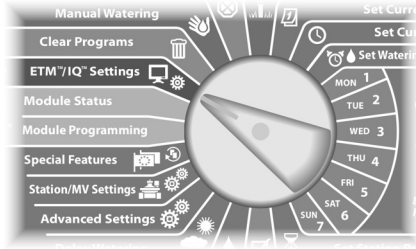

For LX-IVM:

- Turn the controller dial to Advanced Settings and choose Configure Cartridge.

- The IQ Settings main menu is displayed. Use the UP or DOWN arrows to select Status; press Next.

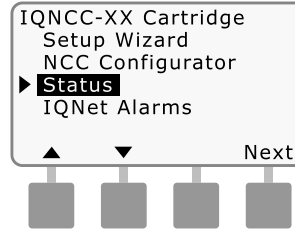

- The Satellite Status screen is displayed. Current status of IQ, Radio, and CM ports are shown. Press Signal to display 4G signal strength.

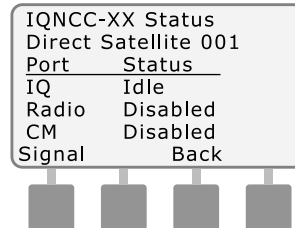

- The Signal Strength screen is displayed. The signal strength between the satellite and the 4G or LAN network is indicated on a scale from 1-10.

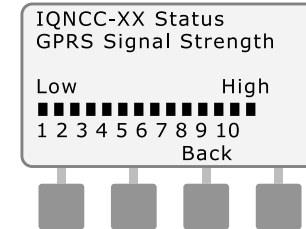

Server Satellite Controllers Ethernet

To display the status of Server Satellites with IQNCCEN cartridge installed:

For LXJ and LXME:

- ② Turn the controller dial to ETM/IQ SETTINGS.

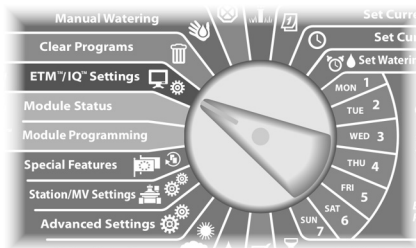

For LX-IVM:

- ② Turn the controller dial to Advanced Settings and choose Configure Cartridge.

- ① The IQ Settings main menu is displayed. Use the UP or DOWN arrows to select Status; press Next

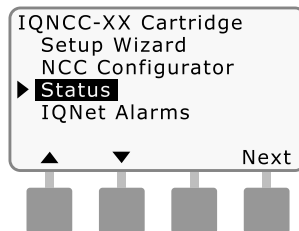

- ② The Satellite Status screen is displayed. Current status of IQ, Radio, and CM ports are shown. Press Ping to check the communication status with selected Clients.

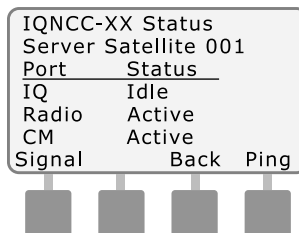

- ③ The IQNet Ping screen is displayed. Use the + and - buttons to select any Client address. Press Ping to check the communication status.

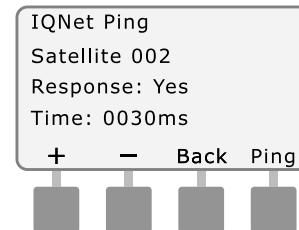

The LCD will display Response-Yes if the ping is successful, or No for an unsuccessful ping. The amount of time until the response was received from the server satellite is listed in milliseconds.

Server Satellite Controllers 4G

To display the status of Server Satellites with IQ4G cartridge installed:

For LXJ and LXME:

- Turn the controller dial to ETM/IQ SETTINGS.

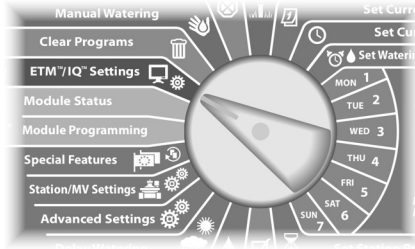

For LX-IVM:

- Turn the controller dial to Advanced Settings and choose Configure Cartridge.

- The IQ Settings main menu is displayed. Use the UP or DOWN arrows to select Status; press Next.

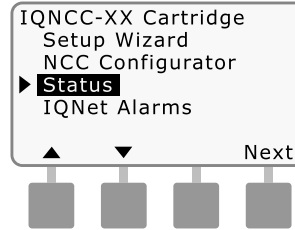

- The Satellite Status screen is displayed. Current status of IQ, Radio, and CM ports are shown. Press Signal to display 4G Cellular signal strength.

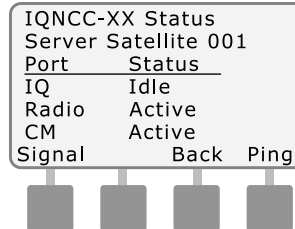

- The Signal Strength screen is displayed. The signal strength between the satellite and the 4G or LAN network is indicated on a scale from 1-10.

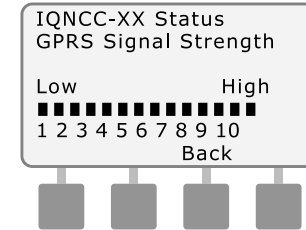

- The Satellite Status screen is displayed. Press Ping to check the communication status with selected Clients.

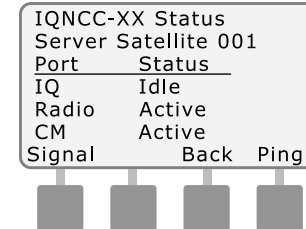

- 5 The IQNet Ping screen is displayed. Use the + and - buttons to select any Client address. Press Ping to check the communication status.

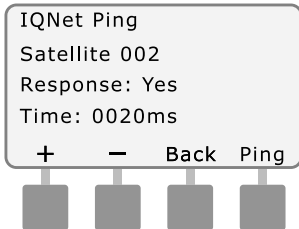

The LCD will display Response-Yes if the ping is successful, or No for an unsuccessful ping. The amount of time until the response was received from the client satellite is listed in milliseconds.

Client Satellite Controllers

To display the status of Client Satellites with any cartridge installed:

For LXD and LXME:

- 2 Turn the controller dial to ETM/IQ SETTINGS.

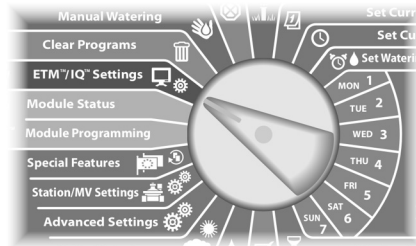

For LX-IVM:

- 2 Turn the controller dial to Advanced Settings and choose Configure Cartridge.

- 1 The IQ Settings main menu is displayed. Use the UP or DOWN arrows to select Status; press Next.

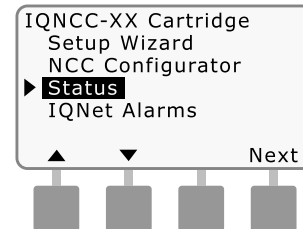

- 2 The Satellite Status screen is displayed. Current status of IQ, Radio, and CM ports are shown.

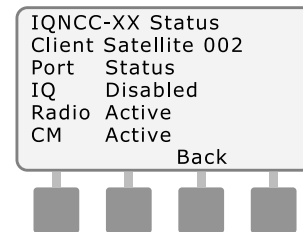

NOTE: The IQ Port status will always show Disabled for Client Satellites.

IQNet Alarms Menu

The IQNet Alarms Menu is used to display communication failures between the Server and Client Satellites.

To Display Alarms:

For LX-D and LX-ME:

- Turn the controller dial to ETM/IQ SETTINGS.

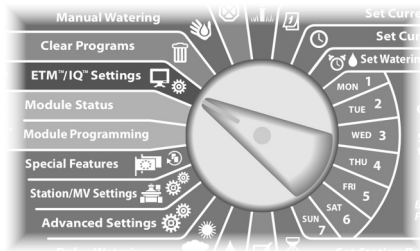

For LX-IVM:

- Turn the controller dial to Advanced Settings and choose Configure Cartridge.

- The IQ Settings main menu is displayed. Use the UP or DOWN arrows to select IQNet Alarms; press Next.

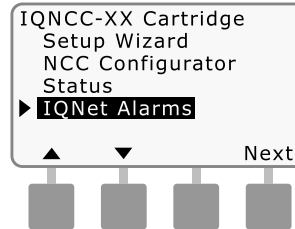

- If there are no alarms, the following screen is displayed.

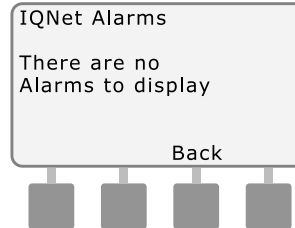

- If there is a communication failure between the Server Satellite and Client Satellites, the IQNet Alarm screen will be displayed on the Server Satellite. Use the UP or DOWN arrows to view other alarms.

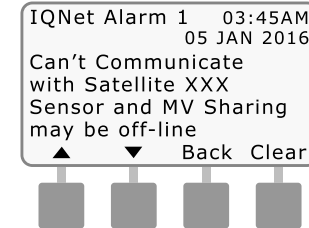

- ④ If there is a communication failure between a Client Satellite and the Server Satellite, the IQNet Alarm screen will be displayed on the Client Satellite. Use the UP or DOWN arrows to view other alarms.

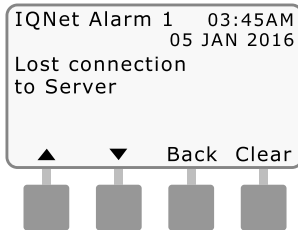

- ⑤ On either IQNet Alarm screen, press Clear to clear all alarms. Press Yes to confirm.

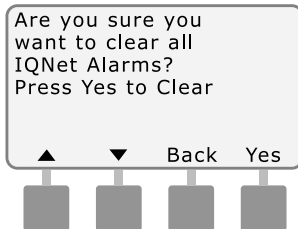

Appendix

Connection Modules Connection Module Options

There are four different types of connection modules that may be installed in Slot 0 of the ESP-LX Series Controller.

The type of connection module that is required for installation of an IQ Network Communication Cartridge depends on the type of controller and on the type of communication required with other satellites (wired or wireless).

Base Module

The **BM-LXME** Base Module is the default module that comes with an ESP-LXME controller. This module can be used with an IQ-NCC when wired communications with other satellites is not required.

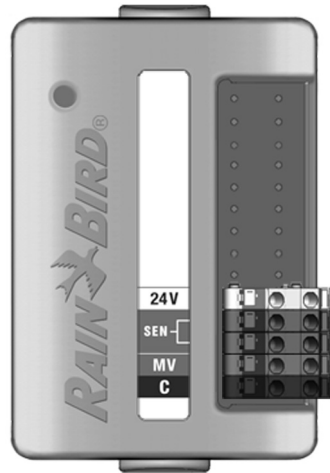

Flow Smart Module

The optional **FSM-LXME** Flow Smart Module used in an ESP-LXME controller can be used with an IQ-NCC when wired communications with other satellites is not required.

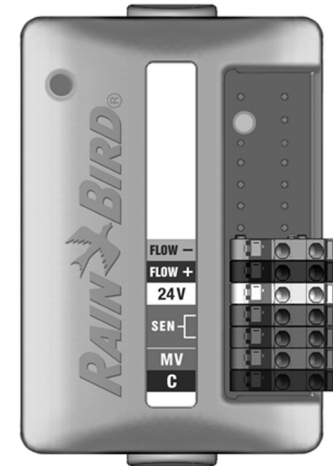

IQ Connection Module

If wired communications (IQNet PE Communication Cable) is required between an ESP-LXD, ESP-LXIVM or ESP-LXIVM Pro satellite and other satellites, an **IQ-CM-LXD** Connection Module must be installed in the ESP-LXD, ESP-LXIVM or ESP-LXIVM Pro satellite to make the connection.

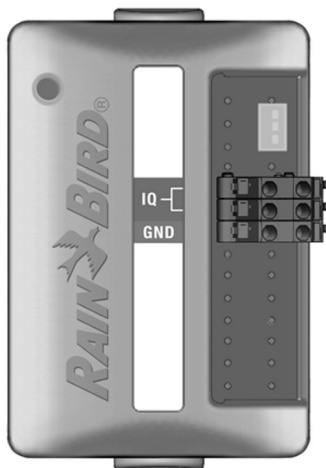

IQ Flow Smart Connection Module

If wired communications (IQNet PE Communication Cable) is required between an ESP-LXME satellite and other satellites, an **IQ-FSCM-LXME** Connection Module must be installed in the ESP-LXME satellite to make the connection.

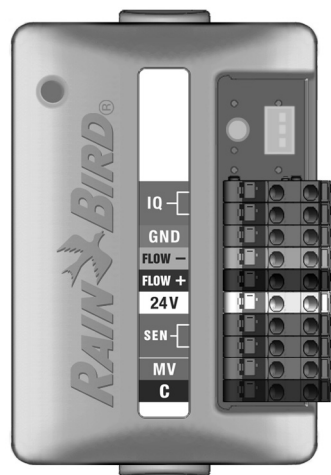

NOTE: See the ESP-LXME Controller Manual for instructions on configuring the Flow Smart Module.

Connection Module Installation

Follow these steps if a connection module is required for IQNet wired communications:

- 1 To remove an existing base module, press in on the two release buttons on each end of the module to release it from slot 0.



NOTE: The ESP-LXD, ESP-LXIVM or ESP-LXIVM Pro does not ship with a base module. Remove the black plastic cover on the backplane in slot 0 to reveal the pins on the connector.

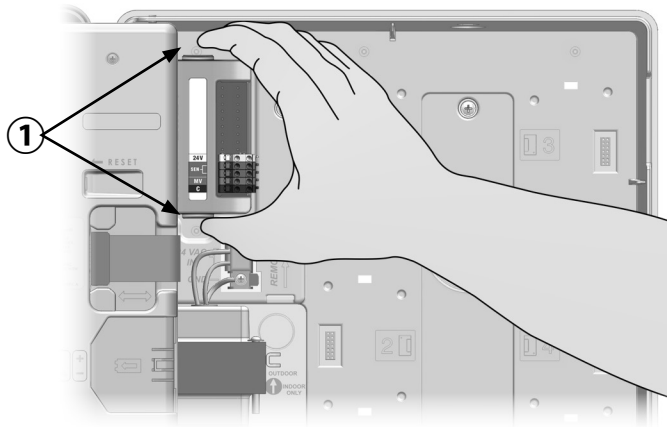

- 2 Orient the connector on the bottom of the IQ-FSCM-LXME or IQ-CM-LXD module with the connection socket on the satellite backplane.
- 3 Carefully fasten the module onto the satellite backplane, pressing firmly until it snaps into place.

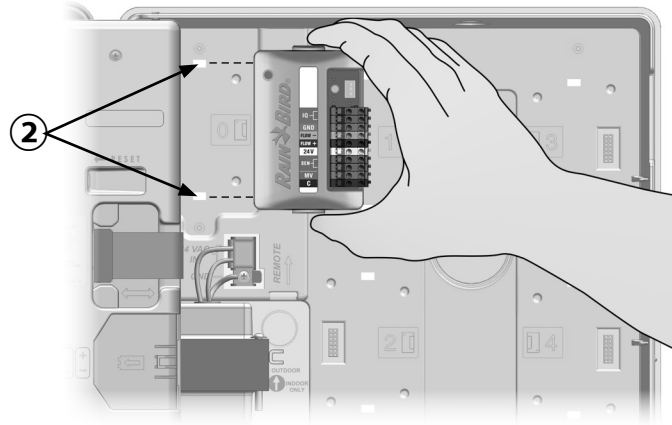

- ④ Connect the green and yellow ground wire to the grounding post on the left side of the satellite backplane.

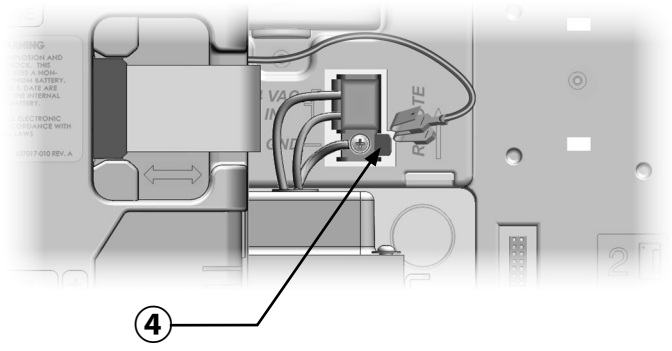

Connect IQ-CM Grounding Wire

An additional ground wire is required if you're installing either an IQ-CM-LXD or IQ-CM-LXME connection module.

- ① Attach one end only of the PE-Cable metal shield to the orange grounding terminal. Optionally connect a grounding wire to Earth ground (electrical ground rod or ground plate).
- ② Route the grounding wire through the knock-out on the bottom of the controller.
- ③ Attach the grounding wire to the CM module GND terminal as shown.

⚠ WARNING

Failure to ensure proper grounding of the connection module could result in risk of electric shock or other hazard to persons, as well as possible equipment damage and malfunction.

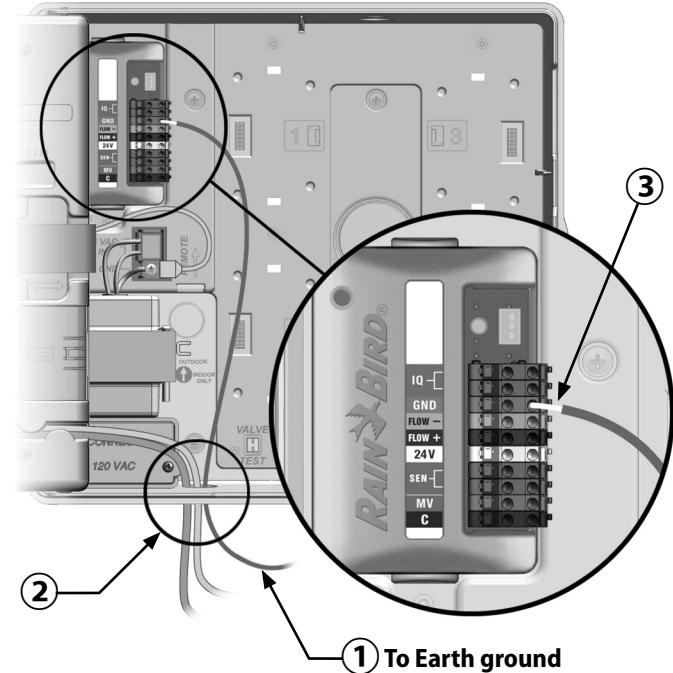

SIM Card Installation

The IQ4G-USA version of the 4G Cellular Cartridge includes a SIM card a 1-year of Cellular service. The IQ4G version of the 4G Cellular Network Communication Cartridge requires the user to source a SIM card with a public static IP address and Cellular Services.

 **NOTE:** An IP address must be obtained from AT&T or another GSM/4G service provider, and must be purchased separately.

Follow these steps to install a SIM card in the IQ4G:

- 1 On the front of the IQ4G, remove the T-shaped access plate by pressing down on the tab.



- 2 Orient the SIM card to match the image of the SIM card as displayed molded on the cartridge (with the “cut-corner” on top and to left as shown).
- 3 Install the SIM card in the slot.

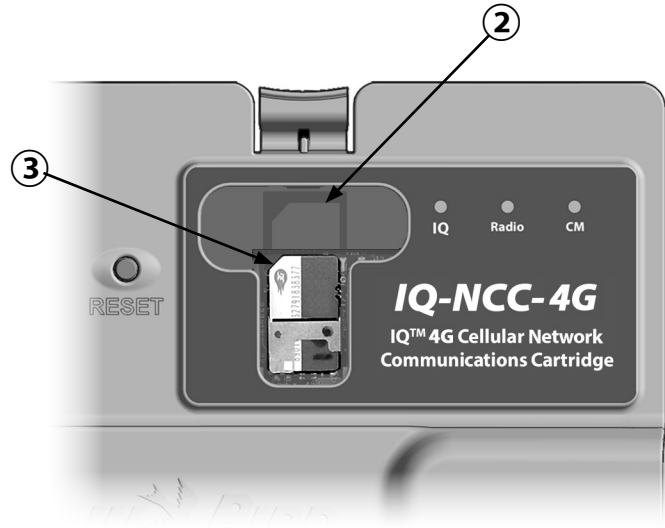

- 4 Replace the access plate.

Regulatory Information

EMC Requirements for the United States

This equipment has been tested and found to comply with the limits for a Class B digital device, pursuant to Part 15 of the FCC Rules. These limits are designed to provide reasonable protection against harmful interference in a residential installation.

This equipment generates, uses, and can radiate radio frequency energy and, if not installed and used in accordance with the instructions, may cause harmful interference to radio communications. However, there is no guarantee that interference will not occur in a particular installation.

If the equipment does cause harmful interference to radio or television reception, which can be determined by turning the equipment off and on, the user is encouraged to try to correct the interference by the following measures:

- Reorient or relocate the receiving antenna.
- Increase the separation between the equipment and the receiver.
- Connect the equipment into an outlet on a circuit different from that to which the receiver is connected.
- Consult the dealer or an experienced radio/TV technician for help.

This device complies with 47 CFR – FCC Part 15 rules. Operation of this device is subject to the following conditions:

1. This device may not cause harmful interference, and
2. This device must accept any interference that may cause undesired operation.

This product was FCC certified under test conditions that included the use of shielded I/O cables and connectors between system components. To be in compliance with FCC regulations, the user must use shielded cables and connectors and install them per instructions.

⚠ WARNING

Changes or modifications not expressly approved by Rain Bird Corporation could void the user's authority to operate the equipment.

This device contains licence-exempt transmitter(s)/ receiver(s) that comply with Innovation, Science and Economic Development Canada's licence-exempt RSS(s). Operation is subject to the following two conditions:

1. This device may not cause interference.
2. This device must accept any interference, including interference that may cause undesired operation of the device.

IMEI

The wireless carrier will require the device's IMEI (International Mobile Equipment Identity) number. This IEMI number is printed on the label on the backside of the modem cartridge.



Rain Bird Corporation
6991 East Southpoint Road
Tucson, AZ 85756
USA
Tel: (520) 741-6100

Rain Bird Corporation
970 W. Sierra Madre Ave.
Azusa, CA 91702
USA
Tel: (626) 812-3400

Rain Bird International
1000 W. Sierra Madre Ave.
Azusa, CA 91702
USA
Tel: +1 (626) 963-9311

**Technical Services for
U.S. and Canada only:**
1 (800) RAINBIRD
1-800-247-3782
www.rainbird.com

© 2020 Rain Bird Corporation. All rights reserved. This material may not be published or reproduced without permission.

® "Rain Bird" and "IQ Central Control System" are registered trademarks of Rain Bird Corporation.

P/N: 638085-02 Rev.01/20