



CONGRATULATIONS! HERE'S YOUR H2O OUTLINE SPRINKLER DESIGN

Rain Bird professionals have designed your custom sprinkler system to the highest standards in the industry. Why? It's the best, most efficient way to water your yard.

Your custom design package includes:

- . Sprinkler head placement and spray patterns
- . Layout of zones, valves, pipe, timer and wire
- . An itemized shopping list of all the parts you will need

UNDERSTANDING YOUR CUSTOM SPRINKLER SYSTEM DESIGN

We've tried to make your sprinkler design easy to understand, but you still may have questions.

Q: Why do I need so many sprinkler heads?

A: Your design is based on professional irrigation design guidelines to achieve optimum coverage suited to your individual lawn and landscape areas. Proper irrigation design provides for "Head to Head" coverage. By spacing the sprinkler heads so that the spray from one head reaches adjacent heads, water is applied evenly. The result, dry spots are eliminated and less water is used to achieve greener, healthier lawn.

Q: Can I eliminate some of the sprinkler heads?

A: If we didn't understand what you want to be watered, deleting some heads may be possible. Did we irrigate areas that you didn't want to water? Maybe we assumed a storage area was lawn. Are there some areas that you prefer to continue watering by hand?

Q: Is it all right to mix different types of sprinklers on the same line?

A: We recommend that you DO NOT mix different types of heads on the same circuit, because each type of sprinkler applies water at a slightly different rate. You may have to overwater parts of your lawn in order to get the right water coverage in other areas.

Q: Why do I need so many zones?

A: The number of zones or valves you need are the result of the amount of water available to use at any one time –or flow. Your flow has been calculated in "gallons per minute" from the information you provided us. Since each sprinkler head uses a specific amount of water, the number of heads that can be connected to a valve is limited to the total requirement of all heads without exceeding your available flow.

Q: Can I reduce the number of zones in my design?

A: Perhaps. Since your design is based on the information you provided us, it's a good idea to re-check the accuracy of your drawing and how you answered the questions. Any errors or changes could make a big difference. Of course, if you're able to eliminate enough sprinkler heads, you may also be able to eliminate a circuit or two.

Q: Can I move the valves, pipe and wire from where they're shown on my design?

A: Yes. Because of graphic limitations, we often show them closer to the center of the lawn that you would like. For instance, you may want to place the valves in a planter area next to the house. Consider your design as a guideline.

Q: How do I know which valve type to use?

A: Local codes usually dictate the type of valve you are allowed to use - whether it's the standard in-line or anti-siphon design. Some cities and towns allow anti-siphon valves, while other cities require back flow preventers. Check with your water company or local building codes to find out which type of valve they require.

Q: Why did you use more valve manifold locations than I requested?

A: It usually makes sense to locate the valves near the zones they serve. This generally improves water distribution as well as reducing the amount of pipe required.

Q: How often should I water my lawn and for how long?

A: Because each lawn is unique, the answer to this question can vary greatly. The best watering times and length of watering depends on your climate, the type of grass and soil conditions. Instead of watering for one long session, water a few times for shorter periods. This will allow water to soak in, while minimizing runoff. For specific information, we suggest you contact your nearest nursery, garden center, or the local horticultural extension office and consult with them about a watering schedule best suited to your area.

Q: What should I do when it rains?

A: Most timers have a button for shutting down for rain. In addition, connecting to a Rain Shutoff Device allows automatic shutdown during rainy weather.

Q: I live in an area where the ground freezes. What should I do to protect my sprinkler system?

A: Please consult our Winterization Guide at www.rainbird.com/pdf/diy/WinterizationGuide.pdf, or call 1-800-RAINBIRD for information.

Q: Where can I get a price list of consumer products?

A: Rain Bird does not publish a general price list for homeowner products because prices vary too much around the country among the various retailers. To obtain phone numbers of local retailers call 1-800-RAINBIRD. If you do not find one or more of our products at the stores, you may also order from us: Please reply to designservice@rainbird.com and ask for your customized order form.

For additional design and installation answers, visit us at http://www.rainbird.com/diy/faqs/faq_designInstall.htm or see our online installation guide at <http://www.rainbird.com/diy/design/installguide.htm>. During or after your installation you may visit our interactive troubleshooting guide at <http://www.rainbird.com/diy/support/itg/index.htm>.

CAUTION: Your design is based on using rain bird products. Other manufacturer's products may not work on this design due to differences in flow, distance of throw, inlet size or other variables.

These plans are offered to you without obligation. They are not and should not be considered the work of a landscape architect or landscape engineer.

TYPICAL PVC PIPE SYSTEM W/IN-LINE VALVE

TIMER TO BE INSTALLED
INSIDE OR IN A
WATER PROOF CABINET



TIMER



HOUSE

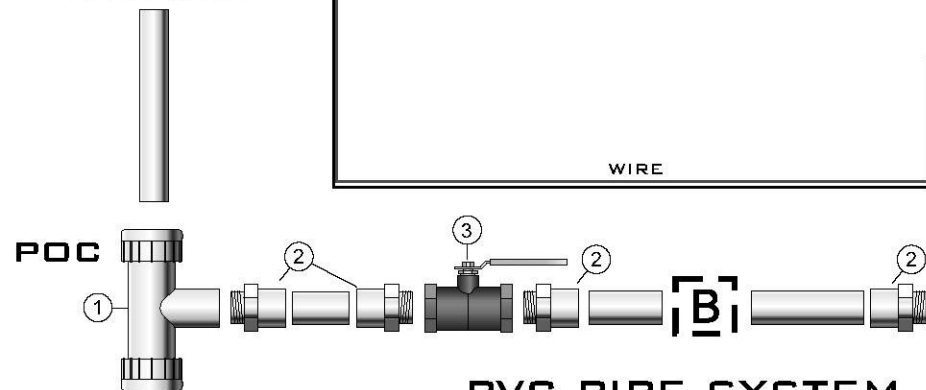

1" RAIN BIRD
AUTOMATIC VALVE
WITH FLOW CONTROL
CPF-100

WIRE

FROM
WATER
METER

REFER TO
NOTE 2

REFER TO
NOTE 2

PVC PIPE SYSTEM ELEVATION PLAN

LEGEND:

1. 1" FPT COMPRESSION TEE, FOR PVC 1".
2. 1" MPT MALE ADAPTER, 1".
3. 1" MASTER SHUTOFF VALVE.
4. SLIP X SLIP COUPLER, 1".
5. VALVES, WIRE @ SOLENOID.
6. SLIP X SLIP X 1/2" FPT TEE, 1".
7. 1/2" PVC SCH. 80 RISER.
8. SHRUB ADAPTER.
9. SLIP X 1/2" FPT ELBOW, 1".
10. 1/2" CUTOFF RISER.
11. SPRINKLER HEAD.
12. SLIP X SLIP X SLIP TEE, 1".
13. SLIP X SLIP ELBOW, 1".

NOTES:



1.- CHECK WITH YOUR LOCAL CODES THAT A BACKFLOW DEVICE MAY BE REQUIRED.

2.- WHEN TDR OR AG-5 ARE SPECIFIED, A 3/4" CLOSE NIPPLE W/SLIP X 3/4" TEE/ELBOW IS TO BE USED. (REFER TO LEGEND NO. 6, 9 & 10)

WATER
METER

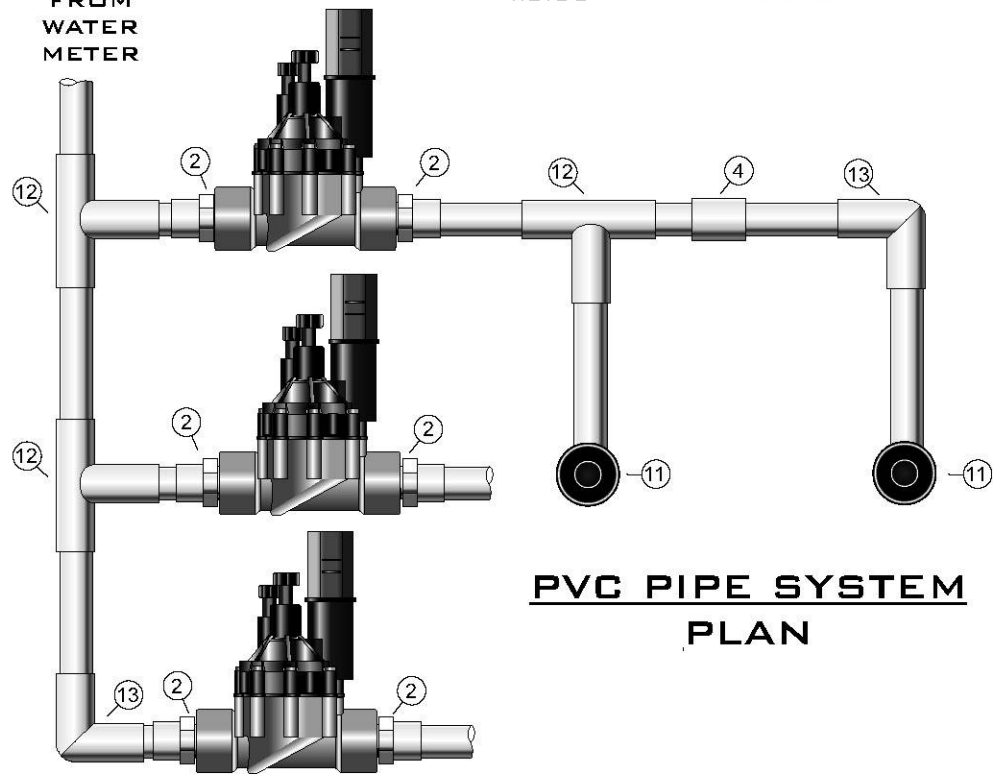

PVC PIPE SYSTEM PLAN

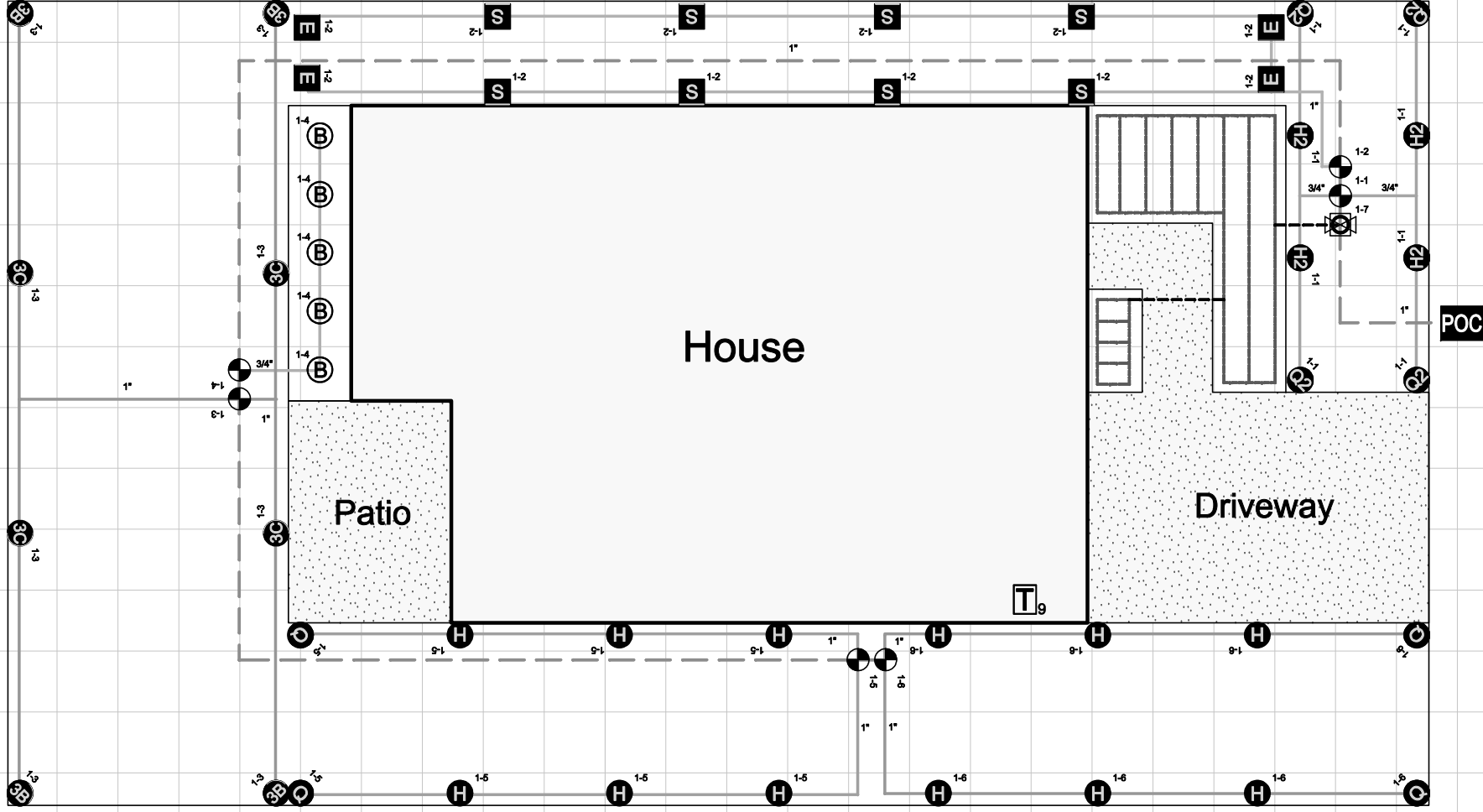

Homeowner to comply with local plumbing codes pertaining to backflow protection and service line connection. The accuracy of your drawing and how well you answer all related questions will determine the accuracy of your custom design.
 RAIN BIRD OFFERS THIS DESIGN ONLY AS A GUIDELINE. NO GUARANTEE OF DESIGN ACCURACY, SYSTEM INSTALLATION OR OPERATION IS IMPLIED.



Scale: Square = 5 x 5 ft
 Sheet: Circuits/Piping
 Date: 11/17/2011
 Design No. SAMPLE01

Custom Designed For:
 John Smith
 0001 Main St
 Springfield, ST 00001
 ((12) 3) -466-

Designed By:
Rain Bird Design Service
 Questions About Your Design?
 Call 1-800-426-7782
 Fax to 1-800-862-4927
 Email to designservice@rainbird.com

Contact Rain Bird
 for Product Questions

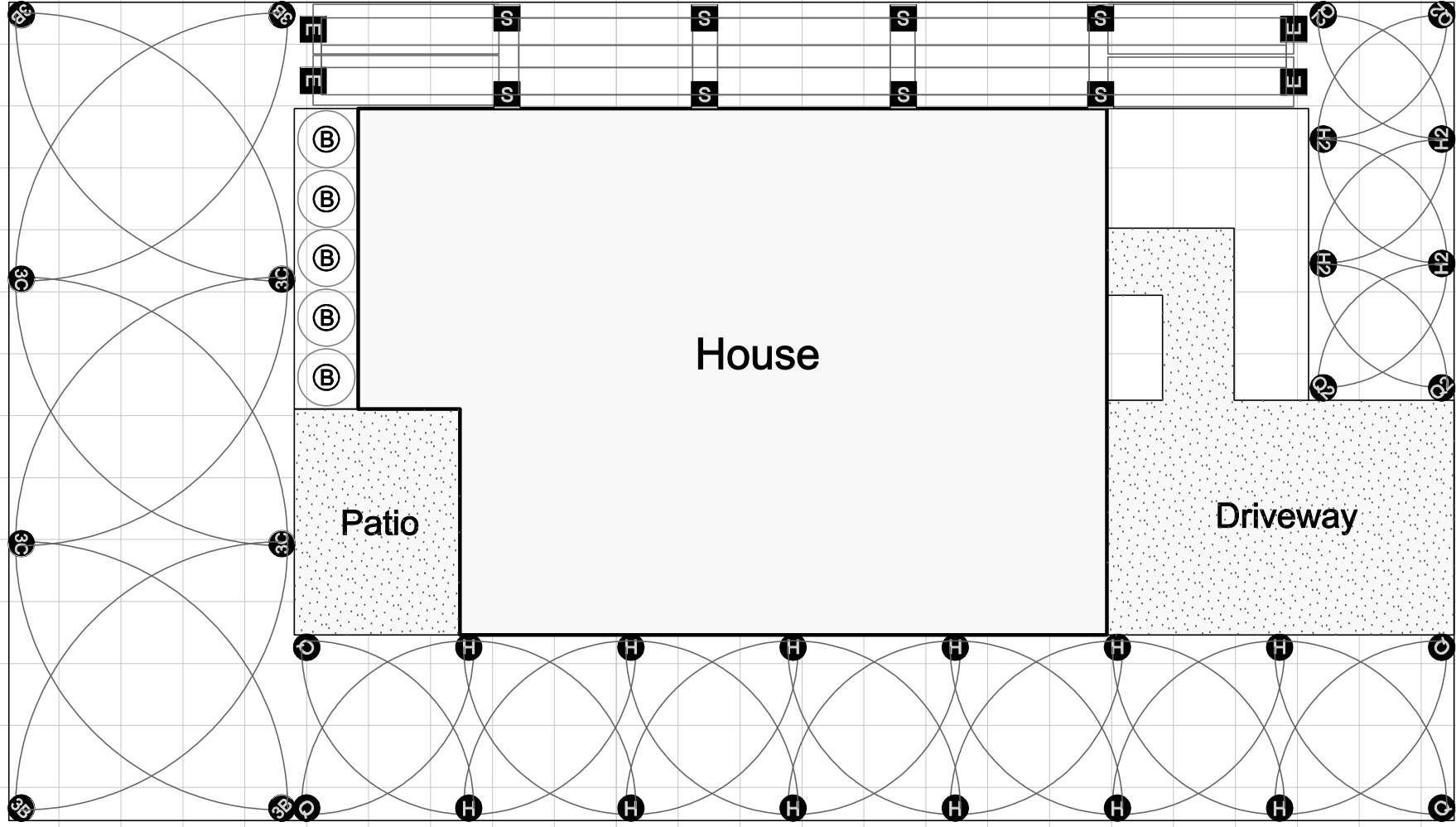
Homeowner to comply with local plumbing codes pertaining to backflow protection and service line connection. The accuracy of your drawing and how well you answer all related questions will determine the accuracy of your custom design. RAIN BIRD OFFERS THIS DESIGN ONLY AS A GUIDELINE. NO GUARANTEE OF DESIGN ACCURACY. SYSTEM INSTALLATION OR OPERATION IS IMPLIED.

Scale: Square = 5 x 5 ft
 Sheet: Sprinklers/Patterns
 Date: 11/17/2011
 Design No. SAMPLE01















Custom Designed For:
 John Smith
 0001 Main St
 Springfield, ST 00001
 ((12) 3) -466-

Designed By:
Rain Bird Design Service
 Questions About Your Design?
 Call 1-800-426-7782
 Fax to 1-800-862-4927
 Email to designservice@rainbird.com

Contact Rain Bird
 for Product Questions

RAIN BIRD®
 SPRINKLER SYSTEM DESIGN
 © Registered trademark of Rain Bird Corporation
 © 2009 Rain Bird Corporation

Irrigation



Qty	Symbol	Description	Part #	Pressure
4		Rain Bird SP40H - SP40	A18101	30
4		Rain Bird SP40Q - SP40	A18102	30
4		Rain Bird SP40EST - SP40	A18104	30
12		Rain Bird SP40H - SP40	A18101	30
4		Rain Bird SP40Q - SP40	A18102	30
8		Rain Bird SP40SST - SP40	A18105	30
4		Rain Bird 32SA 1.0 - 32SA	W32001	45
4		Rain Bird 32SA 1.5 - 32SA	W32001	45
5		Rain Bird 1300 Bubbler	A16097	10
2		Rain Bird CPF075 Valve	B61187	
4		Rain Bird CPF100 Valve	B61287	
1		Rain Bird XCZ-075-PRF	X10306	
1		Rain Bird SST-900i Controller	C50901	
1		3/4 inch Irrigation Meter (Point Of Connection)		
532.61 (ft)	————	Lateral - PVC Class 200 1" Pipe		
96.04 (ft)	————	Lateral - PVC Class 200 3/4" Pipe		
224.13 (ft)	— — — —	Mainline - PVC Schedule 40 1" Pipe		
13.22 (ft)	-----	1/2" Blank Tubing	A50904B	
161.57 (ft)	————	1/2" Emitter Tubing, 18" emitter spc. 2' row spc.	A50901	

Valves and pipe are indicated for graphic clarity. Locate as appropriate.
 Indoor timers to be installed inside or in waterproof cabinet.
 Designed per customer flow test of 12 GPM at 60 PSI.
 If spray heads are used, a pressure regulator of 30 or 40 PSI is recommended in the zone.
 Accuracy of the design is limited to the accuracy of the drawing and information submitted.

** The custom irrigation system design (the "Design") that Rain Bird Corporation ("Rain Bird") is preparing for you is based upon drawings and other information that you provide to Rain Bird, and so the Design will be affected by the accuracy and completeness of this information. Also, the Design is based upon the assumption that Rain Bird products will be used in the irrigation system, and the effectiveness of the Design may be adversely impacted if other manufacturers' products are used. There are no warranties on the Design, express or implied, including with respect to whether the Design complies with applicable codes, nor will Rain Bird be responsible for any incidental or consequential damages.

***Hydraulic calculations maintain water velocity below 5 feet per second.

Homeowner to comply with local plumbing codes pertaining to backflow protection and service line connection. The accuracy of your drawing and how well you answer all related questions will determine the accuracy of your custom design.
 RAIN BIRD OFFERS THIS DESIGN ONLY AS A GUIDELINE. NO GUARANTEE OF DESIGN ACCURACY. SYSTEM INSTALLATION OR OPERATION IS IMPLIED.

 <p>RAIN BIRD SPRINKLER SYSTEM DESIGN <small>® Registered trademark of Rain Bird Corporation © 2009 Rain Bird Corporation</small></p>	<p>Scale: Square = 5 x 5 ft Sheet: Sprinklers/Patterns Date: 11/17/2011 Design No. SAMPLE01</p>	<p>Custom Designed For: John Smith 0001 Main St Springfield, ST 00001 ((12) 3) -466-</p>	<p>Designed By: Rain Bird Design Service Questions About Your Design? Call 1-800-426-7782 Fax to 1-800-862-4927 Email to designservice@rainbird.com</p>
<p>Contact Rain Bird for Product Questions</p> 			

Customer Shopping List

SPRINKLERS

Qty	Description	Model No.	Part No.
8	32SA Simple Adjust Gear Drive Rotor, 19'-32'	32SA	W32001
3	32 SA Nozzle Pack	32SANZLPK	W32005
16	4" Sure Pop Sprinkler - Half Circle	SP40H	A18101
8	4" Sure Pop Sprinkler - Quarter Circle	SP40Q	A18102
4	4" Sure Pop Sprinkler - End Strip Pattern	SP40EST	A18104
8	4" Sure Pop Sprinkler - Side Strip Pattern	SP40SST	A18105
5	Flower Bubbler	1300	A16097

DRIP

Qty	Description	Model No.	Part No.
1	Control Zone Kit, In-Line	CXZ-075-PRF	X10306
1	1/2" Blank Tubing - 50ft	T63-050	A50905B
2	1/2" Emitter Tubing -100ft	ET63918-100	A50901
2	1/2" Barbed Couplings (4 PK)	BC50-4PK	A50704B
4	1/2" Barbed Tees (4 PK)	BT50-4PK	A50705B
2	1/2" Barbed Elbows (4 PK)	BE50-4PK	A50706B
6	1/2" End Closure (2 PK)	EC50-2PK	A50707B
1	1/2" Easy Fit Coupling	EFC25-1PK	A50736
1	Easy Fit 3/4" FPT to 1/2" Drip Adapter	EFPO75F	A50739
4	Galvanized Stakes (1/2") (10 PK)	GS50-10PK	A50708B

AUTOMATIC VALVES

Qty	Description	Model No.	Part No.
4	1" In Line Valve w/Flow Control	CPF-100	B61287

AUTOMATIC TIMERS

Qty	Description	Model No.	Part No.
1	SST-900i Simple to Set Timer, Indoor, 9 Zone	SST-900i	C50901

RAIN BIRD ACCESSORIES

Qty	Description	Model No.	Part No.
2	Grease Caps 10-Pack	WPCONN10	N90300

RAIN BIRD TOOLS

Qty	Description	Model No.	Part No.
1	Emitter Tool	ET-1PK	A50711B
1	Tubing Cutter	TC-1PK	A50712B

PIPE

Qty	UOM	Description
10	10ft Pc	PVC Class 200 3/4" Pipe
54	10ft Pc	PVC Class 200 1" Pipe
23	10ft Pc	PVC Schedule 40 1" Pipe

FITTINGS/ACCESSORIES

Qty	UOM	Description
4	Pcs	Reducing Tee (Soc x Soc x F) 3/4 x 3/4 x 1/2
4	Pcs	Reducing 90° Ell (Soc x F) 3/4 x 1/2
3	Pcs	Tee (Soc x Soc x Soc) 3/4 x 3/4 x 3/4
11	Pcs	Tee (Soc x Soc x Soc) 1 x 1 x 1
3	Pcs	Reducing Male Adapter (M x Soc) 3/4 x 1
1	Pcs	Male Adapter (M x Soc) 3/4 x 3/4
7	Pcs	Male Adapter (M x Soc) 1 x 1
1	Pcs	Reducing Male Adapter (M x Soc) 1 x 3/4
2	Pcs	90° Ell (Soc x Soc) 3/4 x 3/4
13	Pcs	90° Ell (Soc x Soc) 1 x 1
10	Pcs	Reducing 90° Ell (Soc x F) 1 x 1/2
	Ft	18 Gauge Irrigation wire. Customer to calculate quantity based on the main line trench and distance to the controller. See http://www.rainbird.com/homeowner/education/installationguide.htm

RAIN BIRD OPTIONAL EQUIPMENT

Qty	P No.	Description
44	A17080	SA5 Swing Assembly, 6"x1/2"x1/2"

* Underground and Drip fittings/accessories are estimated. Add items as needed.
 ** The custom irrigation system design (the "Design") that Rain Bird Corporation ("Rain Bird") is preparing for you is based upon drawings and other information that you provide to Rain Bird and so the Design will be affected by the accuracy and completeness of this information. Also the Design is based upon the assumption that Rain Bird products will be used in the irrigator system, and the effectiveness of the Design may be adversely impacted if other manufacturers' products are used. There are no warranties on the Design, express or implied, including with respect to whether the Design complies with applicable codes, nor will Rain Bird be responsible for any incidental or consequential damages.

Contact Rain Bird
for Product Questions



Designed By:
Rain Bird Design Service

Questions About Your Design?

Call 1-800-426-7782

Fax to 1-800-862-4927

Email to designservice@rainbird.com

Custom Designed For:

John Smith

0001 Main St

Springfield, ST 00001

(123) 456-7890

john@springfield.com

By: hg

Sheet: Shopping List

Date: 11/17/2011

Design No.

Sample01



SPRINKLER SYSTEM DESIGN

© Registered trademark of Rain Bird Corporation

© 2009 Rain Bird Corporation